

SCIENTIFIC ELEMENTS

(International Book Series)

Vol. I

**Applications of Smarandache's Notions to
Mathematics, Physics, and Other Sciences**

Edited by Yuhua FU, Linfan MAO, and Mihaly BENCZE

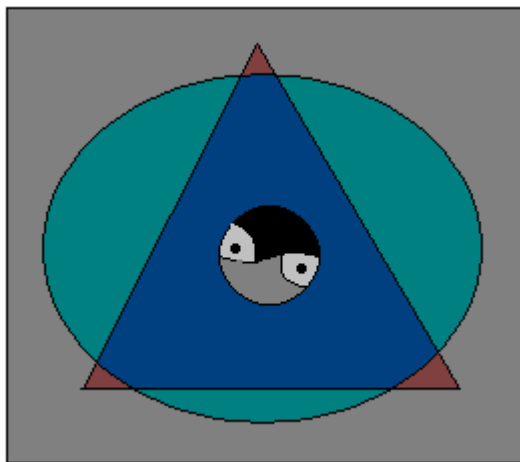

ILQ

November, 2007

Yuhua FU

China Offshore Oil Research Center

Beijing, 100027, P. R. China

fuyh@cnooc.com.cn

Linfan MAO

Academy of Mathematics and Systems

Chinese Academy of Sciences

Beijing 100080, P. R. China

maolinfan@163.com

and

Mihaly BENCZE

Department of Mathematics

Aprily Lajos College

Brasov, Romania

SCIENTIFIC ELEMENTS (I)

Applications of Smarandache's Notions to Mathematics, Physics, and Other Sciences

ILQ

November 2007

This book can be ordered in a paper bound reprint from:

Books on Demand

ProQuest Information & Learning

University of Microfilm International

300 N. Zeeb Road

P. O. Box 1346, Ann Arbor

MI 48106-1346, USA

Tel:1-800-521-0600(Customer Service)

<http://wwwlib.umi.com/bod>

Peer Reviewers:

Linfan Mao, Academy of Mathematics and Systems, Chinese Academy of Sciences, Beijing 100080, P. R.China.

Yuhua Fu, China Offshore Oil Research Center, Beijing, 100027, P. R.China.

Mihaly Bencze, Department of Mathematics, Aprily Lajos College, Brasov, Romania.

J. Y. Yan, Graduate Student School, Chinese Academy of Sciences, Beijing 100083, P. R. China.

E. L.Wei, Information School, China Renmin University, Beijing 100872, P.R.China.

Copyright: 2007 by InfoLearnQuest, editors, and each author/coauthor for his/her paper(s).

ISBN: 978-1-59973-041-7

Printed in the United States of America

Foreword

Science's function is to understand the natural world and develop our society in coordination with its laws. For thousands of years, mankind has never stopped its steps for exploring its behaviors of all kinds. Today, the advanced science and technology have enabled mankind to handle a few events in the society of mankind by the knowledge on natural world. But many questions in different fields on the natural world have no an answer, even some look clear questions for the Universe, for example,

what is true color of the Universe, for instance its dimension?

what is the real face of an event appearing in the natural world, for instance the electromagnetism? how many dimensions has it?

Different people, standing on different views, will differently answers these questions. For being short of knowledge, we can not even distinguish which is the right answer. Today, we have known two heartening mathematical theories for sciences. One of them is the *Smarandache multi-space theory* that came into being by pure logic. Another is the *mathematical combinatorics* motivated by a combinatorial speculation, i.e., *every mathematical science can be reconstructed from or made by combinatorialization.*

Why are they important? We all know a famous proverb, that of the six blind men and an elephant. These blind men were asked to determine what an elephant looks like by having them touch different parts of the elephant's body. The man touched the elephant's leg, tail, trunk, ear, belly, or tusk, and each man claimed that the elephant is like a pillar, a rope, a tree branch, a hand fan, a wall, or a solid pipe, respectively. They entered into an endless argument. Each of them insisted his view was right. *All of you are right!* a wise man explained to them: *why are you telling it differently is*

because each one of you touched a different part of the elephant. So, actually the elephant has all those features what you all said. That is to say an elephant is nothing but a union of those claims of six blind men, i.e., a Smarandache multi-space with some combinatorial structures. The situation for determining the behaviors of natural world is analogous to the blind men determining what an elephant looks like. L.F. Mao said once in an open lecture that Smarandache multi-spaces is the right theory for the natural world.

For a quick glance at the applications of Smarandache's notions to mathematics, physics, and other sciences, this book selects 12 papers for showing applied fields of Smarandache's notions, such as those of Smarandache multi-spaces, Smarandache geometries, Neutrosophy, etc. to mathematics, physics, logic, cosmology. Although each application is a quite elementary one, we already experience its great potential. Authors are assumed for responsibility on their papers selected in this books and it doesn't mean that the editors completely agree their view point in each paper.

The *Scientific Elements* is a serial collection in publication, maybe with different title. All papers on applications of Smarandache's notions to scientific fields are welcome and can be directly sent to the editors by an email.

L.F.Mao, Y.H.Fu, and M.Bencze

Oct. 2007 in Beijing & Brasov

Contents

Foreword	iv
Differential Geometry on Smarandache n-Manifolds	
by Linfan Mao.....	01
A Unified Variational Principle for Quantization in Dynamic Smarandache Multi-Spaces	
by Yuhua Fu.....	18
Theory of Relativity on the Finsler Spacetime	
by Shenglin Cao.....	29
A Revision to Gödel's Incompleteness Theorem by Neutrosophy	
by Yuhua Fu.....	64
Experimental Determination of Photons in Light Quanta $h\nu$ and Interaction with Electrons	
by Jingsong Feng.....	73
Applications of Smarandache's notions to Physics and Conservation of Energy	
by Yuhua Fu.....	88
The Basis of Relativity Theory & a Smarandache Geometrical Model of Macro-Physics	
by Changwei Hu.....	101
Quantum External Force and Unified Universe	
by Zhengda Luo.....	113
New Analysis on the Relativity of Simultaneity	
by Hao Ji.....	125
Applying Neutrosophy to Analyze and Remold the Special Theory of Relativity	
by Xinwei Huang.....	131
A Geometrical Model on Cosmos	
by Yiyi Guan, Tianyu Guan, Shuan Chen, and Yan Zhang.....	148
Combinatorial Differential Geometry	
by Linfan Mao.....	155

Differential Geometry on Smarandache n -Manifolds

Linfan Mao

(Chinese Academy of Mathematics and System Science, Beijing 100080, P.R.China)

E-mail: maolinfan@163.com

Abstract: A Smarandache geometry is a geometry which has at least one Smarandachely denied axiom(1969), i.e., an axiom behaves in at least two different ways within the same space, i.e., validated and invalided, or only invalided but in multiple distinct ways and a Smarandache n -manifold is a n -manifold that support a Smarandache geometry. Iseri provided a construction for Smarandache 2-manifolds by equilateral triangular disks on a plane and a more general way for Smarandache 2-manifolds on surfaces, called *map geometries* was presented by the author in [9] – [10] and [12]. However, few observations for cases of $n \geq 3$ are found on the journals. As a kind of Smarandache geometries, a general way for constructing dimensional n pseudo-manifolds are presented for any integer $n \geq 2$ in this paper. Connection and principal fiber bundles are also defined on these manifolds. Following these constructions, nearly all existent geometries, such as those of *Euclid geometry*, *Lobachevshy-Bolyai geometry*, *Riemann geometry*, *Weyl geometry*, *Kähler geometry* and *Finsler geometry*, ...,etc., are their sub-geometries.

Key Words: Smarandache geometry, Smarandache manifold, pseudo-manifold, pseudo-manifold geometry, multi-manifold geometry, connection, curvature, Finsler geometry, Riemann geometry, Weyl geometry and Kähler geometry.

AMS(2000): 51M15, 53B15, 53B40, 57N16

§1. Introduction

Various geometries are encountered in update mathematics, such as those of *Euclid geometry*, *Lobachevshy-Bolyai geometry*, *Riemann geometry*, *Weyl geometry*, *Kähler geometry* and *Finsler geometry*, ..., etc.. As a branch of geometry, each of them has

been a kind of spacetimes in physics once and contributes successively to increase human's cognitive ability on the natural world. Motivated by a combinatorial notion for sciences: *combining different fields into a unifying field*, Smarandache introduced *neutrosophy and neutrosophic logic* in references [14]–[15] and Smarandache geometries in [16].

Definition 1.1([8][16]) *An axiom is said to be Smarandachely denied if the axiom behaves in at least two different ways within the same space, i.e., validated and invalidated, or only invalidated but in multiple distinct ways.*

A Smarandache geometry is a geometry which has at least one Smarandachely denied axiom(1969).

Definition 1.2 *For an integer $n, n \geq 2$, a Smarandache n -manifold is a n -manifold that support a Smarandache geometry.*

Smarandache geometries were applied to construct many world from conservation laws as a mathematical tool([2]). For Smarandache n -manifolds, Iseri constructed Smarandache manifolds for $n = 2$ by equilateral triangular disks on a plane in [6] and [7] (see also [11] in details). For generalizing Iseri's Smarandache manifolds, *map geometries* were introduced in [9] – [10] and [12], particularly in [12] convinced us that these map geometries are really Smarandache 2-manifolds. Kuciuk and Antholy gave a popular and easily understanding example on an Euclid plane in [8]. Notice that in [13], these *multi-metric space* were defined, which can be also seen as Smarandache geometries. However, few observations for cases of $n \geq 3$ and their relations with existent manifolds in differential geometry are found on the journals. The main purpose of this paper is to give general ways for constructing dimensional n pseudo-manifolds for any integer $n \geq 2$. Differential structure, connection and principal fiber bundles are also introduced on these manifolds. Following these constructions, nearly all existent geometries, such as those of *Euclid geometry, Lobachevshy-Bolyai geometry, Riemann geometry, Weyl geometry, Kähler geometry* and *Finsler geometry, ...,etc.*, are their sub-geometries.

Terminology and notations are standard used in this paper. Other terminology and notations not defined here can be found in these references [1], [3] – [5].

For any integer $n, n \geq 1$, an n -manifold is a Hausdorff space M^n , i.e., a space that satisfies the T_2 separation axiom, such that for $\forall p \in M^n$, there is an open neighborhood $U_p, p \in U_p \subset M^n$ and a homeomorphism $\varphi_p : U_p \rightarrow \mathbf{R}^n$ or \mathbf{C}^n , respectively.

Considering the differentiability of the homeomorphism $\varphi : U \rightarrow \mathbf{R}^n$ enables us to get the conception of differential manifolds, introduced in the following.

An *differential n -manifold* (M^n, \mathcal{A}) is an n -manifold M^n , $M^n = \bigcup_{i \in I} U_i$, endowed with a C^r differential structure $\mathcal{A} = \{(U_\alpha, \varphi_\alpha) | \alpha \in I\}$ on M^n for an integer r with following conditions hold.

- (1) $\{U_\alpha; \alpha \in I\}$ is an open covering of M^n ;
- (2) For $\forall \alpha, \beta \in I$, atlases $(U_\alpha, \varphi_\alpha)$ and (U_β, φ_β) are *equivalent*, i.e., $U_\alpha \cap U_\beta = \emptyset$ or $U_\alpha \cap U_\beta \neq \emptyset$ but the *overlap maps*

$$\varphi_\alpha \varphi_\beta^{-1} : \varphi_\beta(U_\alpha \cap U_\beta) \rightarrow \varphi_\alpha(U_\alpha) \quad \text{and} \quad \varphi_\beta \varphi_\alpha^{-1} : \varphi_\alpha(U_\alpha \cap U_\beta) \rightarrow \varphi_\beta(U_\beta)$$

are C^r ;

- (3) \mathcal{A} is maximal, i.e., if (U, φ) is an atlas of M^n equivalent with one atlas in \mathcal{A} , then $(U, \varphi) \in \mathcal{A}$.

An n -manifold is *smooth* if it is endowed with a C^∞ differential structure. It is well-known that a complex manifold M_c^n is equal to a smooth real manifold M_r^{2n} with a natural base

$$\left\{ \frac{\partial}{\partial x^i}, \frac{\partial}{\partial y^i} \mid 1 \leq i \leq n \right\}$$

for $T_p M_c^n$, where $T_p M_c^n$ denotes the tangent vector space of M_c^n at each point $p \in M_c^n$.

§2. Pseudo-Manifolds

These Smarandache manifolds are non-homogenous spaces, i.e., there are singular or inflection points in these spaces and hence can be used to characterize warped spaces in physics. A generalization of ideas in map geometries can be applied for constructing dimensional n pseudo-manifolds.

Construction 2.1 Let M^n be an n -manifold with an atlas $\mathcal{A} = \{(U_p, \varphi_p) | p \in M^n\}$. For $\forall p \in M^n$ with a local coordinates (x_1, x_2, \dots, x_n) , define a spatially directional mapping $\omega : p \rightarrow \mathbf{R}^n$ action on φ_p by

$$\omega : p \rightarrow \varphi_p^\omega(p) = \omega(\varphi_p(p)) = (\omega_1, \omega_2, \dots, \omega_n),$$

i.e., if a line L passes through $\varphi(p)$ with direction angles $\theta_1, \theta_2, \dots, \theta_n$ with axes $\mathbf{e}_1, \mathbf{e}_2, \dots, \mathbf{e}_n$ in \mathbf{R}^n , then its direction becomes

$$\theta_1 - \frac{\vartheta_1}{2} + \sigma_1, \theta_2 - \frac{\vartheta_2}{2} + \sigma_2, \dots, \theta_n - \frac{\vartheta_n}{2} + \sigma_n$$

after passing through $\varphi_p(p)$, where for any integer $1 \leq i \leq n$, $\omega_i \equiv \vartheta_i(\text{mod}4\pi)$, $\vartheta_i \geq 0$ and

$$\sigma_i = \begin{cases} \pi, & \text{if } 0 \leq \omega_i < 2\pi, \\ 0, & \text{if } 2\pi < \omega_i < 4\pi. \end{cases}$$

A manifold M^n endowed with such a spatially directional mapping $\omega : M^n \rightarrow \mathbf{R}^n$ is called an n -dimensional pseudo-manifold, denoted by $(M^n, \mathcal{A}^\omega)$.

Theorem 2.1 For a point $p \in M^n$ with local chart (U_p, φ_p) , $\varphi_p^\omega = \varphi_p$ if and only if $\omega(p) = (2\pi k_1, 2\pi k_2, \dots, 2\pi k_n)$ with $k_i \equiv 1(\text{mod}2)$ for $1 \leq i \leq n$.

Proof By definition, for any point $p \in M^n$, if $\varphi_p^\omega(p) = \varphi_p(p)$, then $\omega(\varphi_p(p)) = \varphi_p(p)$. According to Construction 2.1, this can only happens while $\omega(p) = (2\pi k_1, 2\pi k_2, \dots, 2\pi k_n)$ with $k_i \equiv 1(\text{mod}2)$ for $1 \leq i \leq n$. \square

Definition 2.1 A spatially directional mapping $\omega : M^n \rightarrow \mathbf{R}^n$ is euclidean if for any point $p \in M^n$ with a local coordinates (x_1, x_2, \dots, x_n) , $\omega(p) = (2\pi k_1, 2\pi k_2, \dots, 2\pi k_n)$ with $k_i \equiv 1(\text{mod}2)$ for $1 \leq i \leq n$, otherwise, non-euclidean.

Definition 2.2 Let $\omega : M^n \rightarrow \mathbf{R}^n$ be a spatially directional mapping and $p \in (M^n, \mathcal{A}^\omega)$, $\omega(p)(\text{mod}4\pi) = (\omega_1, \omega_2, \dots, \omega_n)$. Call a point p elliptic, euclidean or hyperbolic in direction \mathbf{e}_i , $1 \leq i \leq n$ if $0 \leq \omega_i < 2\pi$, $\omega_i = 2\pi$ or $2\pi < \omega_i < 4\pi$.

Then we get a consequence by Theorem 2.1.

Corollary 2.1 Let $(M^n, \mathcal{A}^\omega)$ be a pseudo-manifold. Then $\varphi_p^\omega = \varphi_p$ if and only if every point in M^n is euclidean.

Theorem 2.2 Let $(M^n, \mathcal{A}^\omega)$ be an n -dimensional pseudo-manifold and $p \in M^n$. If there are euclidean and non-euclidean points simultaneously or two elliptic or hyperbolic points in a same direction in (U_p, φ_p) , then $(M^n, \mathcal{A}^\omega)$ is a Smarandache n -manifold.

Proof On the first, we introduce a conception for locally parallel lines in an n -manifold. Two lines C_1, C_2 are said *locally parallel* in a neighborhood (U_p, φ_p) of a point $p \in M^n$ if $\varphi_p(C_1)$ and $\varphi_p(C_2)$ are parallel straight lines in \mathbf{R}^n .

In $(M^n, \mathcal{A}^\omega)$, the axiom that *there are lines pass through a point locally parallel a given line* is Smarandachely denied since it behaves in at least two different ways, i.e., *one parallel, none parallel, or one parallel, infinite parallels, or none parallel, infinite parallels.*

If there are euclidean and non-euclidean points in (U_p, φ_p) simultaneously, not loss of generality, we assume that u is euclidean but v non-euclidean, $\omega(v) \pmod{4\pi} = (\omega_1, \omega_2, \dots, \omega_n)$ and $\omega_1 \neq 2\pi$. Now let L be a straight line parallel the axis \mathbf{e}_1 in \mathbf{R}^n . There is only one line C_u locally parallel to $\varphi_p^{-1}(L)$ passing through the point u since there is only one line $\varphi_p(C_u)$ parallel to L in \mathbf{R}^n by these axioms for Euclid spaces. However, if $0 < \omega_1 < 2\pi$, then there are infinite many lines passing through u locally parallel to $\varphi_p^{-1}(L)$ in (U_p, φ_p) since there are infinite many straight lines parallel L in \mathbf{R}^n , such as those shown in Fig.2.1(a) in where each straight line passing through the point $\bar{u} = \varphi_p(u)$ from the shade field is parallel to L .

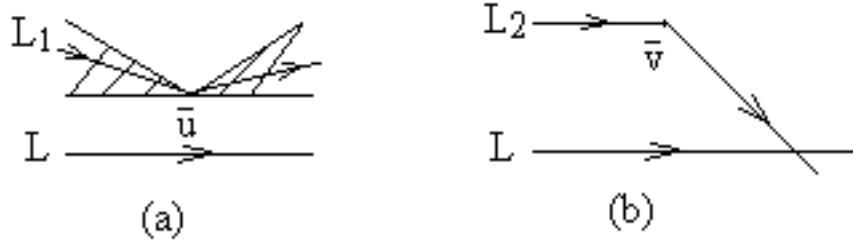

Fig.2.1

But if $2\pi < \omega_1 < 4\pi$, then there are no lines locally parallel to $\varphi_p^{-1}(L)$ in (U_p, φ_p) since there are no straight lines passing through the point $\bar{v} = \varphi_p(v)$ parallel to L in \mathbf{R}^n , such as those shown in Fig.2.1(b).

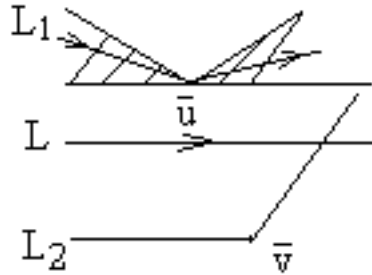

Fig.2.2

If there are two elliptic points u, v along a direction \vec{O} , consider the plane \mathcal{P} determined by $\omega(u), \omega(v)$ with \vec{O} in \mathbf{R}^n . Let L be a straight line intersecting with

the line uv in \mathcal{P} . Then there are infinite lines passing through u locally parallel to $\varphi_p(L)$ but none line passing through v locally parallel to $\varphi_p^{-1}(L)$ in (U_p, φ_p) since there are infinite many lines or none lines passing through $\bar{u} = \omega(u)$ or $\bar{v} = \omega(v)$ parallel to L in \mathbf{R}^n , such as those shown in Fig.2.2.

Similarly, we can also get the conclusion for the case of hyperbolic points. Since there exists a Smarandachely denied axiom in $(M^n, \mathcal{A}^\omega)$, it is a Smarandache manifold. This completes the proof. \square

For an Euclid space \mathbf{R}^n , the homeomorphism φ_p is trivial for $\forall p \in \mathbf{R}^n$. In this case, we abbreviate $(\mathbf{R}^n, \mathcal{A}^\omega)$ to (\mathbf{R}^n, ω) .

Corollary 2.2 *For any integer $n \geq 2$, if there are euclidean and non-euclidean points simultaneously or two elliptic or hyperbolic points in a same direction in (\mathbf{R}^n, ω) , then (\mathbf{R}^n, ω) is an n -dimensional Smarandache geometry.*

Particularly, Corollary 2.2 partially answers an open problem in [12] for establishing Smarandache geometries in \mathbf{R}^3 .

Corollary 2.3 *If there are points $p, q \in \mathbf{R}^3$ such that $\omega(p)(\text{mod}4\pi) \neq (2\pi, 2\pi, 2\pi)$ but $\omega(q)(\text{mod}4\pi) = (2\pi k_1, 2\pi k_2, 2\pi k_3)$, where $k_i \equiv 1(\text{mod}2), 1 \leq i \leq 3$ or p, q are simultaneously elliptic or hyperbolic in a same direction of \mathbf{R}^3 , then (\mathbf{R}^3, ω) is a Smarandache space geometry.*

Definition 2.3 *For any integer $r \geq 1$, a C^r differential Smarandache n -manifold $(M^n, \mathcal{A}^\omega)$ is a Smarandache n -manifold $(M^n, \mathcal{A}^\omega)$ endowed with a differential structure \mathcal{A} and a C^r spatially directional mapping ω . A C^∞ Smarandache n -manifold $(M^n, \mathcal{A}^\omega)$ is also said to be a smooth Smarandache n -manifold.*

According to Theorem 2.2, we get the next result by definitions.

Theorem 2.3 *Let (M^n, \mathcal{A}) be a manifold and $\omega : M^n \rightarrow \mathbf{R}^n$ a spatially directional mapping action on \mathcal{A} . Then $(M^n, \mathcal{A}^\omega)$ is a C^r differential Smarandache n -manifold for an integer $r \geq 1$ if the following conditions hold:*

- (1) *there is a C^r differential structure $\mathcal{A} = \{(U_\alpha, \varphi_\alpha) | \alpha \in I\}$ on M^n ;*
- (2) *ω is C^r ;*
- (3) *there are euclidean and non-euclidean points simultaneously or two elliptic or hyperbolic points in a same direction in (U_p, φ_p) for a point $p \in M^n$.*

Proof The condition (1) implies that (M^n, \mathcal{A}) is a C^r differential n -manifold and conditions (2), (3) ensure $(M^n, \mathcal{A}^\omega)$ is a differential Smarandache manifold by

definitions and Theorem 2.2. □

For a smooth differential Smarandache n -manifold $(M^n, \mathcal{A}^\omega)$, a function $f : M^n \rightarrow \mathbf{R}$ is said smooth if for $\forall p \in M^n$ with an chart (U_p, φ_p) ,

$$f \circ (\varphi_p^\omega)^{-1} : (\varphi_p^\omega)(U_p) \rightarrow \mathbf{R}^n$$

is smooth. Denote by \mathfrak{S}_p all these C^∞ functions at a point $p \in M^n$.

Definition 2.4 Let $(M^n, \mathcal{A}^\omega)$ be a smooth differential Smarandache n -manifold and $p \in M^n$. A tangent vector v at p is a mapping $v : \mathfrak{S}_p \rightarrow \mathbf{R}$ with these following conditions hold.

- (1) $\forall g, h \in \mathfrak{S}_p, \forall \lambda \in \mathbf{R}, v(h + \lambda h) = v(g) + \lambda v(h);$
- (2) $\forall g, h \in \mathfrak{S}_p, v(gh) = v(g)h(p) + g(p)v(h).$

Denote all tangent vectors at a point $p \in (M^n, \mathcal{A}^\omega)$ by $T_p M^n$ and define addition and scalar multiplication for $\forall u, v \in T_p M^n, \lambda \in \mathbf{R}$ and $f \in \mathfrak{S}_p$ by

$$(u + v)(f) = u(f) + v(f), \quad (\lambda u)(f) = \lambda \cdot u(f).$$

Then it can be shown immediately that $T_p M^n$ is a vector space under these two operations and.

Let $p \in (M^n, \mathcal{A}^\omega)$ and $\gamma : (-\varepsilon, \varepsilon) \rightarrow \mathbf{R}^n$ be a smooth curve in \mathbf{R}^n with $\gamma(0) = p$. In $(M^n, \mathcal{A}^\omega)$, there are four possible cases for tangent lines on γ at the point p , such as those shown in Fig.2.3, in where these bold lines represent tangent lines.

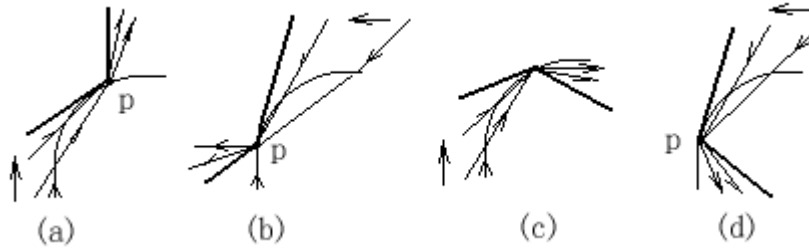

Fig.2.3

By these positions of tangent lines at a point p on γ , we conclude that *there is one tangent line at a point p on a smooth curve if and only if p is euclidean in $(M^n, \mathcal{A}^\omega)$* . This result enables us to get the dimensional number of a tangent vector space $T_p M^n$ at a point $p \in (M^n, \mathcal{A}^\omega)$.

Theorem 2.4 For any point $p \in (M^n, \mathcal{A}^\omega)$ with a local chart (U_p, φ_p) , $\varphi_p(p) =$

$(x_1^0, x_2^0, \dots, x_n^0)$, if there are just s euclidean directions along $\mathbf{e}_{i_1}, \mathbf{e}_{i_2}, \dots, \mathbf{e}_{i_s}$ for a point, then the dimension of $T_p M^n$ is

$$\dim T_p M^n = 2n - s$$

with a basis

$$\left\{ \frac{\partial}{\partial x^{i_j}} \Big|_p \mid 1 \leq j \leq s \right\} \cup \left\{ \frac{\partial^-}{\partial x^l} \Big|_p, \frac{\partial^+}{\partial x^l} \Big|_p \mid 1 \leq l \leq n \text{ and } l \neq i_j, 1 \leq j \leq s \right\}.$$

Proof We only need to prove that

$$\left\{ \frac{\partial}{\partial x^{i_j}} \Big|_p \mid 1 \leq j \leq s \right\} \cup \left\{ \frac{\partial^-}{\partial x^l}, \frac{\partial^+}{\partial x^l} \Big|_p \mid 1 \leq l \leq n \text{ and } l \neq i_j, 1 \leq j \leq s \right\} \quad (2.1)$$

is a basis of $T_p M^n$. For $\forall f \in \mathfrak{S}_p$, since f is smooth, we know that

$$\begin{aligned} f(x) &= f(p) + \sum_{i=1}^n (x_i - x_i^0) \frac{\partial^{\epsilon_i} f}{\partial x_i}(p) \\ &+ \sum_{i,j=1}^n (x_i - x_i^0)(x_j - x_j^0) \frac{\partial^{\epsilon_i} f}{\partial x_i} \frac{\partial^{\epsilon_j} f}{\partial x_j} + R_{i,j,\dots,k} \end{aligned}$$

for $\forall x = (x_1, x_2, \dots, x_n) \in \varphi_p(U_p)$ by the Taylor formula in \mathbf{R}^n , where each term in $R_{i,j,\dots,k}$ contains $(x_i - x_i^0)(x_j - x_j^0) \cdots (x_k - x_k^0)$, $\epsilon_l \in \{+, -\}$ for $1 \leq l \leq n$ but $l \neq i_j$ for $1 \leq j \leq s$ and ϵ_l should be deleted for $l = i_j, 1 \leq j \leq s$.

Now let $v \in T_p M^n$. By Definition 2.4(1), we get that

$$\begin{aligned} v(f(x)) &= v(f(p)) + v\left(\sum_{i=1}^n (x_i - x_i^0) \frac{\partial^{\epsilon_i} f}{\partial x_i}(p)\right) \\ &+ v\left(\sum_{i,j=1}^n (x_i - x_i^0)(x_j - x_j^0) \frac{\partial^{\epsilon_i} f}{\partial x_i} \frac{\partial^{\epsilon_j} f}{\partial x_j}\right) + v(R_{i,j,\dots,k}). \end{aligned}$$

Application of the condition (2) in Definition 2.4 shows that

$$\begin{aligned} v(f(p)) &= 0, \quad \sum_{i=1}^n v(x_i^0) \frac{\partial^{\epsilon_i} f}{\partial x_i}(p) = 0, \\ v\left(\sum_{i,j=1}^n (x_i - x_i^0)(x_j - x_j^0) \frac{\partial^{\epsilon_i} f}{\partial x_i} \frac{\partial^{\epsilon_j} f}{\partial x_j}\right) &= 0 \end{aligned}$$

and

$$v(R_{i,j,\dots,k}) = 0.$$

Whence, we get that

$$v(f(x)) = \sum_{i=1}^n v(x_i) \frac{\partial^{\epsilon_i} f}{\partial x_i}(p) = \sum_{i=1}^n v(x_i) \frac{\partial^{\epsilon_i}}{\partial x_i} \Big|_p (f). \quad (2.2)$$

The formula (2.2) shows that any tangent vector v in $T_p M^n$ can be spanned by elements in (2.1).

All elements in (2.1) are linearly independent. Otherwise, if there are numbers $a^1, a^2, \dots, a^s, a_1^+, a_1^-, a_2^+, a_2^-, \dots, a_{n-s}^+, a_{n-s}^-$ such that

$$\sum_{j=1}^s a_{i_j} \frac{\partial}{\partial x_{i_j}} + \sum_{i \neq i_1, i_2, \dots, i_s, 1 \leq i \leq n} a_i^{\epsilon_i} \frac{\partial^{\epsilon_i}}{\partial x_i} \Big|_p = 0,$$

where $\epsilon_i \in \{+, -\}$, then we get that

$$a_{i_j} = \left(\sum_{j=1}^s a_{i_j} \frac{\partial}{\partial x_{i_j}} + \sum_{i \neq i_1, i_2, \dots, i_s, 1 \leq i \leq n} a_i^{\epsilon_i} \frac{\partial^{\epsilon_i}}{\partial x_i} \right) (x_{i_j}) = 0$$

for $1 \leq j \leq s$ and

$$a_i^{\epsilon_i} = \left(\sum_{j=1}^s a_{i_j} \frac{\partial}{\partial x_{i_j}} + \sum_{i \neq i_1, i_2, \dots, i_s, 1 \leq i \leq n} a_i^{\epsilon_i} \frac{\partial^{\epsilon_i}}{\partial x_i} \right) (x_i) = 0$$

for $i \neq i_1, i_2, \dots, i_s, 1 \leq i \leq n$. Therefore, (2.1) is a basis of the tangent vector space $T_p M^n$ at the point $p \in (M^n, \mathcal{A}^\omega)$. \square

Notice that $\dim T_p M^n = n$ in Theorem 2.4 if and only if all these directions are euclidean along $\mathbf{e}_1, \mathbf{e}_2, \dots, \mathbf{e}_n$. We get a consequence by Theorem 2.4.

Corollary 2.4([4]-[5]) *Let (M^n, \mathcal{A}) be a smooth manifold and $p \in M^n$. Then*

$$\dim T_p M^n = n$$

with a basis

$$\left\{ \frac{\partial}{\partial x^i} \Big|_p \mid 1 \leq i \leq n \right\}.$$

Definition 2.5 *For $\forall p \in (M^n, \mathcal{A}^\omega)$, the dual space $T_p^* M^n$ is called a co-tangent vector space at p .*

Definition 2.6 For $f \in \mathfrak{S}_p$, $d \in T_p^*M^n$ and $v \in T_pM^n$, the action of d on f , called a differential operator $d : \mathfrak{S}_p \rightarrow \mathbf{R}$, is defined by

$$df = v(f).$$

Then we immediately get the following result.

Theorem 2.5 For any point $p \in (M^n, \mathcal{A}^\omega)$ with a local chart (U_p, φ_p) , $\varphi_p(p) = (x_1^0, x_2^0, \dots, x_n^0)$, if there are just s euclidean directions along $\mathbf{e}_{i_1}, \mathbf{e}_{i_2}, \dots, \mathbf{e}_{i_s}$ for a point, then the dimension of $T_p^*M^n$ is

$$\dim T_p^*M^n = 2n - s$$

with a basis

$$\{dx^{i_j}|_p \mid 1 \leq j \leq s\} \cup \{d^-x^l, d^+x^l|_p \mid 1 \leq l \leq n \text{ and } l \neq i_j, 1 \leq j \leq s\},$$

where

$$dx^i|_p \left(\frac{\partial}{\partial x^j} \Big|_p \right) = \delta_j^i \text{ and } d^{\epsilon_i}x^i|_p \left(\frac{\partial^{\epsilon_i}}{\partial x^j} \Big|_p \right) = \delta_j^i$$

for $\epsilon_i \in \{+, -\}$, $1 \leq i \leq n$.

§3. Pseudo-Manifold Geometries

Here we introduce *Minkowski norms* on these pseudo-manifolds $(M^n, \mathcal{A}^\omega)$.

Definition 3.1 A *Minkowski norm* on a vector space V is a function $F : V \rightarrow \mathbf{R}$ such that

- (1) F is smooth on $V \setminus \{0\}$ and $F(v) \geq 0$ for $\forall v \in V$;
- (2) F is 1-homogenous, i.e., $F(\lambda v) = \lambda F(v)$ for $\forall \lambda > 0$;
- (3) for all $y \in V \setminus \{0\}$, the symmetric bilinear form $g_y : V \times V \rightarrow \mathbf{R}$ with

$$g_y(u, v) = \sum_{i,j} \frac{\partial^2 F(y)}{\partial y^i \partial y^j}$$

is positive definite for $u, v \in V$.

Denote by $TM^n = \bigcup_{p \in (M^n, \mathcal{A}^\omega)} T_pM^n$.

Definition 3.2 A pseudo-manifold geometry is a pseudo-manifold $(M^n, \mathcal{A}^\omega)$ endowed with a Minkowski norm F on TM^n .

Then we get the following result.

Theorem 3.1 There are pseudo-manifold geometries.

Proof Consider an euclidean $2n$ -dimensional space \mathbf{R}^{2n} . Then there exists a Minkowski norm $F(\bar{x}) = |\bar{x}|$ at least. According to Theorem 2.4, $T_p M^n$ is $\mathbf{R}^{s+2(n-s)}$ if $\omega(p)$ has s euclidean directions along $\mathbf{e}_1, \mathbf{e}_2, \dots, \mathbf{e}_n$. Whence there are Minkowski norms on each chart of a point in $(M^n, \mathcal{A}^\omega)$.

Since (M^n, \mathcal{A}) has finite cover $\{(U_\alpha, \varphi_\alpha) | \alpha \in I\}$, where I is a finite index set, by the decomposition theorem for unit, we know that there are smooth functions $h_\alpha, \alpha \in I$ such that

$$\sum_{\alpha \in I} h_\alpha = 1 \text{ with } 0 \leq h_\alpha \leq 1.$$

Choose a Minkowski norm F^α on each chart $(U_\alpha, \varphi_\alpha)$. Define

$$F_\alpha = \begin{cases} h_\alpha F^\alpha, & \text{if } p \in U_\alpha, \\ 0, & \text{if } p \notin U_\alpha \end{cases}$$

for $\forall p \in (M^n, \varphi^\omega)$. Now let

$$F = \sum_{\alpha \in I} F_\alpha.$$

Then F is a Minkowski norm on TM^n since it satisfies all of these conditions (1)–(3) in Definition 3.1. \square

Although the dimension of each tangent vector space maybe different, we can also introduce *principal fiber bundles* and *connections* on pseudo-manifolds.

Definition 3.3 A principal fiber bundle (PFB) consists of a pseudo-manifold $(P, \mathcal{A}_1^\omega)$, a projection $\pi : (P, \mathcal{A}_1^\omega) \rightarrow (M, \mathcal{A}_0^{\pi(\omega)})$, a base pseudo-manifold $(M, \mathcal{A}_0^{\pi(\omega)})$ and a Lie group G , denoted by (P, M, ω^π, G) such that (1), (2) and (3) following hold.

(1) There is a right freely action of G on $(P, \mathcal{A}_1^\omega)$, i.e., for $\forall g \in G$, there is a diffeomorphism $R_g : (P, \mathcal{A}_1^\omega) \rightarrow (P, \mathcal{A}_1^\omega)$ with $R_g(p^\omega) = p^\omega g$ for $\forall p \in (P, \mathcal{A}_1^\omega)$ such that $p^\omega(g_1 g_2) = (p^\omega g_1) g_2$ for $\forall p \in (P, \mathcal{A}_1^\omega)$, $\forall g_1, g_2 \in G$ and $p^\omega e = p^\omega$ for some $p \in (P^n, \mathcal{A}_1^\omega)$, $e \in G$ if and only if e is the identity element of G .

- (2) The map $\pi : (P, \mathcal{A}_1^\omega) \rightarrow (M, \mathcal{A}_0^{\pi(\omega)})$ is onto with $\pi^{-1}(\pi(p)) = \{pg | g \in G\}$, $\pi\omega_1 = \omega_0\pi$, and regular on spatial directions of p , i.e., if the spatial directions of p are $(\omega_1, \omega_2, \dots, \omega_n)$, then ω_i and $\pi(\omega_i)$ are both elliptic, or euclidean, or hyperbolic and $|\pi^{-1}(\pi(\omega_i))|$ is a constant number independent of p for any integer $i, 1 \leq i \leq n$.
- (3) For $\forall x \in (M, \mathcal{A}_0^{\pi(\omega)})$ there is an open set U with $x \in U$ and a diffeomorphism $T_u^{\pi(\omega)} : (\pi)^{-1}(U^{\pi(\omega)}) \rightarrow U^{\pi(\omega)} \times G$ of the form $T_u(p) = (\pi(p^\omega), s_u(p^\omega))$, where $s_u : \pi^{-1}(U^{\pi(\omega)}) \rightarrow G$ has the property $s_u(p^\omega g) = s_u(p^\omega)g$ for $\forall g \in G, p \in \pi^{-1}(U)$.

We know the following result for principal fiber bundles of pseudo-manifolds.

Theorem 3.2 *Let (P, M, ω^π, G) be a PFB. Then*

$$(P, M, \omega^\pi, G) = (P, M, \pi, G)$$

if and only if all points in pseudo-manifolds $(P, \mathcal{A}_1^\omega)$ are euclidean.

Proof For $\forall p \in (P, \mathcal{A}_1^\omega)$, let (U_p, φ_p) be a chart at p . Notice that $\omega^\pi = \pi$ if and only if $\varphi_p^\omega = \varphi_p$ for $\forall p \in (P, \mathcal{A}_1^\omega)$. According to Theorem 2.1, by definition this is equivalent to that all points in $(P, \mathcal{A}_1^\omega)$ are euclidean. \square

Definition 3.4 *Let (P, M, ω^π, G) be a PFB with $\dim G = r$. A subspace family $H = \{H_p | p \in (P, \mathcal{A}_1^\omega), \dim H_p = \dim T_{\pi(p)}M\}$ of TP is called a connection if conditions (1) and (2) following hold.*

- (1) *For $\forall p \in (P, \mathcal{A}_1^\omega)$, there is a decomposition*

$$T_p P = H_p \oplus V_p$$

and the restriction $\pi_|_{H_p} : H_p \rightarrow T_{\pi(p)}M$ is a linear isomorphism.*

- (2) *H is invariant under the right action of G , i.e., for $p \in (P, \mathcal{A}_1^\omega), \forall g \in G$,*

$$(R_g)_* H_p = H_{pg}.$$

Similar to Theorem 3.2, the conception of connection introduced in Definition 3.4 is more general than the popular connection on principal fiber bundles.

Theorem 3.3(dimensional formula) *Let (P, M, ω^π, G) be a PFB with a connection H . For $\forall p \in (P, \mathcal{A}_1^\omega)$, if the number of euclidean directions of p is $\lambda_P(p)$, then*

$$\dim V_p = \frac{(\dim P - \dim M)(2\dim P - \lambda_P(p))}{\dim P}.$$

Proof Assume these euclidean directions of the point p being $\mathbf{e}_1, \mathbf{e}_2, \dots, \mathbf{e}_{\lambda_P(p)}$. By definition π is regular, we know that $\pi(\mathbf{e}_1), \pi(\mathbf{e}_2), \dots, \pi(\mathbf{e}_{\lambda_P(p)})$ are also euclidean in $(M, \mathcal{A}_1^{\pi(\omega)})$. Now since

$$\pi^{-1}(\pi(\mathbf{e}_1)) = \pi^{-1}(\pi(\mathbf{e}_2)) = \dots = \pi^{-1}(\pi(\mathbf{e}_{\lambda_P(p)})) = \mu = \text{constant},$$

we get that $\lambda_P(p) = \mu\lambda_M$, where λ_M denotes the correspondent euclidean directions in $(M, \mathcal{A}_1^{\pi(\omega)})$. Similarly, consider all directions of the point p , we also get that $\dim P = \mu\dim M$. Thereafter

$$\lambda_M = \frac{\dim M}{\dim P} \lambda_P(p). \quad (3.1)$$

Now by Definition 3.4, $T_p P = H_p \oplus V_p$, i.e.,

$$\dim T_p P = \dim H_p + \dim V_p. \quad (3.2)$$

Since $\pi_*|_{H_p} : H_p \rightarrow T_{\pi(p)} M$ is a linear isomorphism, we know that $\dim H_p = \dim T_{\pi(p)} M$. According to Theorem 2.4, we have formulae

$$\dim T_p P = 2\dim P - \lambda_P(p)$$

and

$$\dim T_{\pi(p)} M = 2\dim M - \lambda_M = 2\dim M - \frac{\dim M}{\dim P} \lambda_P(p).$$

Now replacing all these formulae into (3.2), we get that

$$2\dim P - \lambda_P(p) = 2\dim M - \frac{\dim M}{\dim P} \lambda_P(p) + \dim V_p.$$

That is,

$$\dim V_p = \frac{(\dim P - \dim M)(2\dim P - \lambda_P(p))}{\dim P}. \quad \square$$

We immediately get the following consequence by Theorem 3.3.

Corollary 3.1 *Let (P, M, ω^π, G) be a PFB with a connection H . Then for $\forall p \in (P, \mathcal{A}_1^\omega)$,*

$$\dim V_p = \dim P - \dim M$$

if and only if the point p is euclidean.

Now we consider conclusions included in Smarandache geometries, particularly in pseudo-manifold geometries.

Theorem 3.4 *A pseudo-manifold geometry (M^n, φ^ω) with a Minkowski norm on TM^n is a Finsler geometry if and only if all points of (M^n, φ^ω) are euclidean.*

Proof According to Theorem 2.1, $\varphi_p^\omega = \varphi_p$ for $\forall p \in (M^n, \varphi^\omega)$ if and only if p is euclidean. Whence, by definition (M^n, φ^ω) is a Finsler geometry if and only if all points of (M^n, φ^ω) are euclidean. \square

Corollary 3.1 *There are inclusions among Smarandache geometries, Finsler geometry, Riemann geometry and Weyl geometry:*

$$\begin{aligned} &\{\text{Smarandache geometries}\} \supset \{\text{pseudo-manifold geometries}\} \\ &\supset \{\text{Finsler geometry}\} \supset \{\text{Riemann geometry}\} \supset \{\text{Weyl geometry}\}. \end{aligned}$$

Proof The first and second inclusions are implied in Theorems 2.1 and 3.3. Other inclusions are known in a textbook, such as [4] – [5]. \square

Now we consider complex manifolds. Let $z^i = x^i + \sqrt{-1}y^i$. In fact, any complex manifold M_c^n is equal to a smooth real manifold M^{2n} with a natural base $\{\frac{\partial}{\partial x^i}, \frac{\partial}{\partial y^i}\}$ for $T_p M_c^n$ at each point $p \in M_c^n$. Define a *Hermite* manifold M_c^n to be a manifold M_c^n endowed with a Hermite inner product $h(p)$ on the tangent space $(T_p M_c^n, J)$ for $\forall p \in M_c^n$, where J is a mapping defined by

$$J\left(\frac{\partial}{\partial x^i}\Big|_p\right) = \frac{\partial}{\partial y^i}\Big|_p, \quad J\left(\frac{\partial}{\partial y^i}\Big|_p\right) = -\frac{\partial}{\partial x^i}\Big|_p$$

at each point $p \in M_c^n$ for any integer $i, 1 \leq i \leq n$. Now let $h(p) = g(p) + \sqrt{-1}\kappa(p)$, $p \in M_c^n$. Then a *Kähler manifold* is defined to be a Hermite manifold (M_c^n, h) with a closed κ satisfying

$$\kappa(X, Y) = g(X, JY), \quad \forall X, Y \in T_p M_c^n, \forall p \in M_c^n.$$

Similar to Theorem 3.3 for real manifolds, we know the next result.

Theorem 3.5 *A pseudo-manifold geometry (M_c^n, φ^ω) with a Minkowski norm on TM^n is a Kähler geometry if and only if F is a Hermite inner product on M_c^n with all points of (M^n, φ^ω) being euclidean.*

Proof Notice that a complex manifold M_c^n is equal to a real manifold M^{2n} . Similar to the proof of Theorem 3.3, we get the claim. \square

As a immediately consequence, we get the following inclusions in Smarandache geometries.

Corollary 3.2 *There are inclusions among Smarandache geometries, pseudo-manifold geometry and Kähler geometry:*

$$\begin{aligned} \{\text{Smarandache geometries}\} &\supset \{\text{pseudo - manifold geometries}\} \\ &\supset \{\text{Kähler geometry}\}. \end{aligned}$$

§4. Further Discussions

Undoubtedly, there are many and many open problems and research trends in pseudo-manifold geometries. Further research these new trends and solving these open problems will enrich one's knowledge in sciences.

Firstly, we need to get these counterpart in pseudo-manifold geometries for some important results in Finsler geometry or Riemann geometry.

4.1. Stokes Theorem *Let (M^n, \mathcal{A}) be a smoothly oriented manifold with the T_2 axiom hold. Then for $\forall \varpi \in A_0^{n-1}(M^n)$,*

$$\int_{M^n} d\varpi = \int_{\partial M^n} \varpi.$$

This is the well-known Stokes formula in Riemann geometry. If we replace (M^n, \mathcal{A}) by $(M^n, \mathcal{A}^\omega)$, *what will happens?* Answer this question needs to solve problems following.

- (1) *Establish an integral theory on pseudo-manifolds.*
- (2) *Find conditions such that the Stokes formula hold for pseudo-manifolds.*

4.2. Gauss-Bonnet Theorem *Let S be an orientable compact surface. Then*

$$\int \int_S K d\sigma = 2\pi\chi(S),$$

where K and $\chi(S)$ are the Gauss curvature and Euler characteristic of S This formula is the well-known Gauss-Bonnet formula in differential geometry on surfaces.

Then *what is its counterpart in pseudo-manifold geometries?* This need us to solve problems following.

- (1) *Find a suitable definition for curvatures in pseudo-manifold geometries.*
- (2) *Find generalizations of the Gauss-Bonnet formula for pseudo-manifold geometries, particularly, for pseudo-surfaces.*

For a oriently compact Riemann manifold (M^{2p}, g) , let

$$\Omega = \frac{(-1)^p}{2^{2p} \pi^p p!} \sum_{i_1, i_2, \dots, i_{2p}} \delta_{1, \dots, 2p}^{i_1, \dots, i_{2p}} \Omega_{i_1 i_2} \wedge \dots \wedge \Omega_{i_{2p-1} i_{2p}},$$

where Ω_{ij} is the curvature form under the natural chart $\{e_i\}$ of M^{2p} and

$$\delta_{1, \dots, 2p}^{i_1, \dots, i_{2p}} = \begin{cases} 1, & \text{if permutation } i_1 \dots i_{2p} \text{ is even,} \\ -1, & \text{if permutation } i_1 \dots i_{2p} \text{ is odd,} \\ 0, & \text{otherwise.} \end{cases}$$

Chern proved that^{[4]–[5]}

$$\int_{M^{2p}} \Omega = \chi(M^{2p}).$$

Certainly, these new kind of global formulae for pseudo-manifold geometries are valuable to find.

4.3. Gauge Fields Physicists have established a gauge theory on principal fiber bundles of Riemann manifolds, which can be used to unite gauge fields with gravitation. Similar consideration for pseudo-manifold geometries will induce new gauge theory, which enables us to asking problems following.

Establish a gauge theory on those of pseudo-manifold geometries with some additional conditions.

- (1) *Find these conditions such that we can establish a gauge theory on a pseudo-manifold geometry.*
- (2) *Find the Yang-Mills equation in a gauge theory on a pseudo-manifold geometry.*
- (2) *Unify these gauge fields and gravitation.*

References

- [1] R.Abraham, J.E.Marsden and T.Ratiu, *Manifolds, tensor analysis, and applications*, Addison-Wesley Publishing Company, Inc. 1983.
- [2] G.Bassini and S.Capozziello, Multi-Spaces and many worlds from conservation laws, *Progress in Physics*, Vol.4(2006), 65-72.
- [3] D.Bleecker, *Gauge theory and variational principles*, Addison-Wesley Publishing Company, Inc. 1981.
- [4] S.S.Chern and W.H.Chern, *Lectures in Differential Geometry*(in Chinese), Peking University Press, 2001.
- [5] W.H.Chern and X.X.Li, *Introduction to Riemann Geometry*, Peking University Press, 2002.
- [6] H.Iseri, *Smarandache manifolds*, American Research Press, Rehoboth, NM,2002.
- [7] H.Iseri, *Partially Paradoxist Smarandache Geometries*, <http://www.gallup.unm.edu/~smar-andache/Howard-Iseri-paper.htm>.
- [8] L.Kuciuk and M.Antholy, An Introduction to Smarandache Geometries, *Mathematics Magazine, Aurora, Canada*, Vol.12(2003).
- [9] L.F.Mao, *On Automorphisms groups of Maps, Surfaces and Smarandache geometries*, *Sientia Magna*, Vol.1(2005), No.2, 55-73.
- [10] L.F.Mao, A new view of combinatorial maps by Smarandache's notion, *Selected Papers on Mathematical Combinatorics*(I), 49-74, World Academic Union, 2006.
- [11] L.F.Mao, *Automorphism Groups of Maps, Surfaces and Smarandache Geometries*, American Research Press, 2005.
- [12] L.F.Mao, *Smarandache multi-space theory*, Hexis, Phoenix, AZ, 2006.
- [13] L.F.Mao, On multi-metric spaces, *Scientia Magna*, Vol.2, No.1(2006), 87-94.
- [14] F.Smarandache, *A Unifying Field in Logics. Neutrosopy: Neturosophic Probability, Set, and Logic*, American research Press, Rehoboth, 1999.
- [15] F.Smarandache, A Unifying Field in Logic: Neutrosophic Field, *Multi-Valued Logic*, Vol.8, No.3(2002)(special issue on Neutrosophy and Neutrosophic Logic), 385-438.
- [16] F.Smarandache, Mixed noneuclidean geometries, *eprint arXiv: math/0010119*, 10/2000.

A Unified Variational Principle for Quantization in Dynamic Smarandache Multi-Spaces

Yuhua Fu

(China Offshore Oil Research Center, Beijing, 100027, China)

E-mail: fuyh@cnooc.com.cn

Abstract: The applications of Dynamic Smarandache Multi-Space (DSMS) Theory are discussed in this paper. Assume that different equations are established for n different dynamic spaces (where n is a dynamic positive integer and a function of time), and these n different dynamic spaces combine to form a DSMS, and they are mutually interacted. Some new coupled equations need to be established in the DSMS to replace some equations in the original dynamic spaces, and some other equations need to be added to account for the contact, boundary conditions and so on. For a unified treatment of all equations in the DSMS, this paper proposes a quantization process for all variables and all equations and a unified variational principle for quantization using a collocation method based on the method of weighted residuals, and we may simultaneously solve all equations in the DSMS with the optimization method. With the unified variational principle of quantization in the DSMS and the fractal quantization method, we pave a way for a unified treatment of problems in the theory of relativity and the quantum mechanics, and a unified treatment of problems related with the four fundamental interactions. Finally a coupled solution for problems of relativity and quantum mechanics is discussed.

Key words: Dynamic Smarandache multi-space (DSMS), coupled equation, collocation method, unified variational principle of quantization, fractal quantization, four foundational interactions, unified processing.

In this paper we first discuss the structure of Dynamic Smarandache Multi-Space (DSMS), then discuss new coupled equations in the DSMS, unified treatment of all

equations in the DSMS, the quantization of all variables and equations with the collocation method based on the method of weighted residuals, variable quantization method, fractal quantization method, the unified variational principle of quantization, the coupled solution of problems of relativity and quantum mechanics.

1. Smarandache multi-spaces and dynamic Smarandache multi-space

The notion of Smarandache multi-spaces was proposed by Smarandache in 1969^[1-3]. A Smarandache multi-space is a union

$$M = M_1 \cup M_2 \cup \dots \cup M_n$$

of n sets or subspaces M_1, M_2, \dots, M_n , where n is an integer with $n \geq 1$.

If n is a constant, the correspondent Smarandache multi-space is called a *static multi-space*.

In many practical problems, with a continuous change of the value of n and the structure of the sets or subspaces, a dynamic multi-space should be considered.

We define a dynamic Smarandache multi-space (DSMS) as a union

$$M(t) = M_1(t) \cup M_2(t) \cup \dots \cup M_{n(t)}(t)$$

or

$$M = \bigcup_{i=1}^{n(t)} M_i$$

of $n(t)$ sets or subspaces $M_1(t), M_2(t), \dots, M_{n(t)}(t)$, where $n(t)$ is an integer-valued function of time t and $n(t) \geq 1$.

2. Unified variational principle in a single space

In reference [4], a unified variational principle of fluid mechanics was proposed for a single fluid space.

2.1 Optimization method of weighted residuals

Optimization method of weighted residuals (OMWR) has been used for solving problems in mechanics, physics and astronomy^[5], which can be stated as follows.

For an operator equation

$$F = 0 \text{ in domain } V \tag{1}$$

with boundary condition

$$B = 0 \text{ on boundary } S. \quad (2)$$

The functional Π defined by OMWR will take the minimum value

$$\Pi = \int_V A^+(F)dV + W \int_S A^+(B)dS = \min_0, \quad (3)$$

where

$$A^+(F) = 0 \text{ if } F = 0 \text{ and } A^+(F) > 0 \text{ if } F \neq 0, \quad (4)$$

is a non-negative functional on F .

Let \min_0 denote minimum and its value should be equal to zero. Function $A^+(F)$ was first introduced in the reference [6]. W is a positive weighted number, and in many cases $W = 1$. How to choose W was discussed in the reference [7].

If we set $A^+(F) = F^2$, Eq.3 gives the *Least Squares Method*. It has been discussed these cases of $A^+(F) = |F|$, F^4 , $\sqrt{|F|}$, $|e^F - 1|$, $|F|_{\max}$ and the others in the reference [7].

Obviously the condition of zero minimum value of functional Π in Eq.(3) is equivalent to the solution of Eqs.(1) and (2), whose proof was given in reference [4].

It should be noted that, if the domain V consists of n discrete points P_1, P_2, \dots, P_n , and the boundary S with m discrete points Q_1, Q_2, \dots, Q_m (such as in quantization problems that we will discuss later in this paper), the integrals in Eq.(3) should be replaced by a summation

$$\Pi = \sum_1^n W_i A^+(F(P_i)) + W \sum_1^m W_j A^+(B(Q_j)) = \min_0 \quad (3')$$

In addition, the establishment of functional Π in OMWR is very easy, and the minimum value of Π is known in advance (equal to zero).

To find the minimum value of Π , two methods can be used. One is to solve the equations given by the stationary condition $\Pi' = 0$. Another is to use the optimization methods proposed in references [4-8], such as the steepest descent method, searching method, etc..

2.2. A unified variational principle of fluid mechanics (UVPFM)

We have known some basic equations in fluid mechanics with boundary conditions:

$$\textbf{Continuity equation: } F = 0 \text{ in a domain } V. \quad (5)$$

$$\textbf{Equation of motion: } G = 0 \text{ in a domain } V. \quad (6)$$

$$\textbf{Energy equation: } H = 0 \text{ in a domain } V. \quad (7)$$

$$\textbf{Constitutive equation: } I = 0 \text{ in domain } V. \quad (8)$$

$$\textbf{Equation of state: } J = 0 \text{ in domain } V. \quad (9)$$

$$\textbf{Boundary condition: } B = 0 \text{ on boundary } S. \quad (10)$$

From OMWR, the UVPFM can be obtained as in the following form:

$$\begin{aligned} \Pi = & W_1 \int_V A^+(F)dV + W_2 \int_V A^+(G)dV + W_3 \int_V A^+(H)dV \\ & + W_4 \int_V A^+(I)dV + W_5 \int_V A^+(J)dV + W_6 \int_S A^+(B)dS = \min_0, \end{aligned} \quad (11)$$

where W_i are properly chosen positive weighted numbers, $A^+(F)A^+(G)$ and the others are non-negative functionals defined by Eq.(4).

This method can be used to unify various water gravity wave theories[8], and to obtain solutions of hydrodynamics equation for the solitary domain or for the solitary point (point solution)[4]. In the solving process, it is not necessary to consider the compatibility conditions related with other domain or other points.

3. The unified variational principle in the DSMS

In the DSMS , we have to consider the following equations:

The equations that are established in the original $n(t)$ sets or subspaces, and are still valid in the DSMS

$$F_i = 0 \text{ in domain } V_i, i = 1, 2, \dots, n(t). \quad (12)$$

The boundary conditions that are established in the original $n(t)$ sets or subspaces, and are still valid in the DSMS

$$B_i = 0 \text{ on boundary } S_i, i = 1, 2, \dots, n(t) \quad (13)$$

As the $n(t)$ different dynamic sets or subspaces combine to form a DSMS, they will be mutually interacted, therefore, some new coupled equations are needed in the DSMS to replace some equations in the original dynamic sets or subspaces, and other equations should be added to account for the contact, boundary conditions and so on. Here the contact conditions are those that should be satisfied in the case that two sets or subspaces have some common elements.

To establish the new coupled equations in the DSMS, the existing coupled equations in physics can be considered, such as the pressure-velocity coupled equation, temperature-stress coupled equation, and so on.

Suppose all the new coupled equations, the contact and boundary conditions and so on have been established, for the sake of convenience, they will be written in the unified form as follows (in which V_j may be a domain or boundary),

$$C_j = 0 \text{ for } V_j, j = 1, 2, \dots, m(t). \quad (14)$$

According to OMWR, the unified variational principle in the DSMS can be established as follows

$$\begin{aligned} \Pi &= \sum_1^{n(t)} W_{1i} \int_{V_i} A^+(F_i) dV_i + \sum_1^{n(t)} W_{2i} \int_{S_i} A^+(B_i) dS_i \\ &+ \sum_1^{m(t)} W_{3j} \int_{V_j} A^+(C_j) dV_j = \min_0 \quad (15) \end{aligned}$$

It should be noted that, if the domain V_i , boundary S_i and domain V_j consist of $n'(t)$ points $P_{i1}, P_{i2}, \dots, P_{in'}$, $m'(t)$ points $Q_{i1}, Q_{i2}, \dots, Q_{im'}$ and $k(t)$ points $P_{j1}, P_{j2}, \dots, P_{jk}$, respectively, the integral in Eq.(15) should be replaced by a summation, and the unified variational principle of quantization may be written as

$$\begin{aligned} \Pi &= \sum_1^{n(t)} W_{1i} \sum_1^{n'(t)} W_{i'} A^+(F_i(P_{i'i'})) + \sum_1^{n(t)} W_{2i} \sum_1^{m'(t)} W_{i''} A^+(B_i(Q_{i''})) \\ &+ \sum_1^{m(t)} W_{3j} \sum_1^{k(t)} W_{j'} A^+(C_j(P_{j'j'})) = \min_0 \quad (15') \end{aligned}$$

4. Variable quantization and equation quantization

Two methods can be used for variable quantization: average value method and representative value method.

With the average value method, the value of a whole interval is represented by the average value in this interval.

For example, consider a spaceship navigating along a straight line with a speed varying continually. We may consider five consecutive segments on the straight line, and use the average speed on each line segment to represent the speed of the entire line segment, then the speed of the spacecraft is no longer continuous, we call that speed quantization (similarly, we may define quantization of other parameters such as energy and temperature).

With the representative value method, the value of a whole interval is represented by the value of a representative point chosen properly in this interval.

For the equation quantization, we can only use the representative value method, because the solution of the equation is not known in advance.

The finite difference method and the finite element method are typical representative value methods for the equation quantization.

Obviously, quantization methods for variable and equation can be used for all problems described by continuous variables.

5. Fractal quantization

The quantization can also be achieved by fractal method, by taking integers for certain variables in formulas of fractal distribution.

The fractal distribution is described by

$$N = \frac{C}{r^D} \quad (16)$$

Now, with this fractal distribution, we carry out the quantization for the value of N . Namely, let N take values of consecutive integers: $N = 1, 2, 3, \dots$.

For example, consider the average velocities of the nine planets (unit: km/s) in their orbital motion in the solar system. Let the characteristic dimension r be the value of the average velocity of some planet's orbital motion, and the value of N serve as the index to planets according to the values of their orbital motion average velocity in descending order. For Mercury, $r = 47.89$, which is the greatest, so we let $N = 1$ and have the coordinate point $(47.89, 1)$. Similarly we obtain other 8 planet coordinate points as $(35.03, 2)$, $(29.79, 3)$, $(24.13, 4)$, $(13.06, 5)$, $(9.64, 6)$, $(6.81, 7)$, $(5.43, 8)$, $(4.74, 9)$. The above 9 coordinate points may be plotted on the double logarithmic coordinates, and we obtain 8 straight-line segments. In applying Smarandache geometry and neutrosophic methods, we do not fit these 9 points into a curve with least squares method, instead, we use the 8 straight lines, to accurately determine their fractal parameters (constant C and fractal dimension D). For example, according to Mercury's coordinates $(47.89, 1)$ and Venus's coordinates $(35.03, 2)$, we may obtain the fractal parameters for the first straight-line segment: $C = 5302.684$, $D = 2.216639$. The fractal distribution for the first straight-line segment is expressed by $N = \frac{5302.684}{r^{2.216639}}$, which may be used as an extrapolation formula to predict the average velocity of the next planet (Earth) by substituting $N = 3$ into this formula and solving for the value of r . Similarly, we can make other predictions.

The predictions may be summarized as follows.

By using the 1st straight-line segment, the predicted average velocity of the next planet (Earth) is $V = 29.17$, with an error of 2.07%.

By using the 2nd straight-line segment, the predicted average velocity of the next planet (Mars) is $V = 26.55$, with an error of 10.0%.

By using the 3rd straight-line segment, the predicted average velocity of the next planet (Jupiter) is $V = 20.49$, with an error of 59.9%.

By using the 4th straight-line segment, the predicted average velocity of the next planet (Saturn) is $V = 7.91$, with an error of 18.0%.

By using the 5th straight-line segment, the predicted average velocity of the next planet (Uranus) is $V = 7.46$, with an error of 9.51%.

By using the 6th straight-line segment, the predicted average velocity of the next planet (Neptune) is $V = 5.04$, with an error of 7.19%.

By using the 7th straight-line segment, the predicted average velocity of the next planet (Pluto) is $V = 4.45$, with an error of 6.18%.

By using the 8th straight-line segment, the predicted average velocity of the next planet (tenth planet) is $V = 4.20$, and the error is unknown, because the tenth planet has not yet been discovered.

We can also use the concept of variable dimension fractal, introduced in [9], where the fractal dimension D is a variable instead of a constant, for example

$$D = a_0 + a_1 r + a_2 r^2 + \dots + a_n r^n \quad (17)$$

In some cases, for convenience, the fractal distribution can be written in the following form

$$\ln N = \ln C - D \ln r \quad (18)$$

Substituting Eq.(17) into Eq.(18), we obtain a form, with which it would be easier for one to handle the fractal quantization

$$\ln N = \ln C - (a_0 + a_1 r + a_2 r^2 + \dots + a_n r^n) \ln r \quad (19)$$

Namely

$$F = \ln C - (a_0 + a_1r + a_2r^2 + \dots + a_nr^n) \ln r - \ln N = 0 \quad (20)$$

6. Application of unified variational principle of quantization and fractal quantization

Now we discuss a unified treatment of problems of special relativity and quantum mechanics. Consider the problems of the wavelength of Balmer series in atomic spectrum of hydrogen and the ultimate speed experiment.

From quantum mechanics, the wavelength of Balmer series in atomic spectrum of hydrogen may be obtained theoretically as

$$\lambda(n) = 9.112 \frac{4n^2}{n^2 - 4} \quad n = 3, 4, 5. \quad (21)$$

Table 1 shows a comparison with experimental data $\lambda_0(3), \lambda_0(4), \lambda_0(5)$, with small errors.

In order to obtain better results, we choose $n = 3, 4, 5$ as the representative points, using the fractal quantization method and assume that

$$\lambda_1(n) = \frac{C_1}{n^{D_1}} \quad n = 3, 4, 5. \quad (22)$$

The detailed form will be determined with variational principle of quantization.

Table1. Wavelength of Balmer series in atomic spectrum of hydrogen

value of n	3	4	5
experimental value of λ_0	6562	4861	4340
quantum mechanics method	6561	4860	4339
variational principle of quantization (non-coupled solution)	6562	4861	4340
variational principle of quantization (coupled solution)	6562	4861	4340

In special relativity, the ultimate speed can be expressed as

$$v^2(E_k) = c^2 [1 - (1 + \frac{E_k}{m_0c^2})^{-2}] \quad (23)$$

From table 2 below we can see that a comparison with the Bertozzi experimental value of v_0^2 sees also some small errors.

In order to obtain better results, we use the fractal quantization method assuming

$$v_1^2(E_k) = \frac{C_2}{E_k^{D_2}} \quad E_k = 1.1, 1.8, 4.7 \quad (24)$$

Table 2. Bertozzi ultimate speed experiment

value of energy E_k	1.1	1.8	4.7
experimental value of v_0^2	7.5	8.2	8.5
special relativity	8.09	8.55	8.91
variational principle of quantization (non-coupled solution)	7.5	8.2	8.5
variational principle of quantization (coupled solution)	7.5	8.2	8.5

Using variational principle (15') and Least Squares Method, with the weighted number being taken as 1, we have

$$\Pi = \Pi_1 + \Pi_2 = \min_0, \quad (25)$$

where $\Pi_1 = \sum_{n=3,4,5} [\ln \lambda_1(n) - \ln \lambda_0(n)]^2$ and $\Pi_2 = \sum_{E_k=1.1,1.8,4.7} [\ln v_1^2(E_k) - \ln v_0^2(E_k)]^2$.

Because the coupled equation of quantum mechanics and special relativity has not been established, there are not such terms in Eq.(25).

Now we proceed to find the solution of Eq.(25). First we discuss the non-coupled solution, where the quantum mechanics solution and the special relativity solution are not interacted.

In Eqs.(22) and (24), we assume that

$$D_1 = a_0 + a_1 n,$$

$$D_2 = b_0 + b_1 E_k.$$

Then the solution of Eq.(25) is obtained by

$$\frac{\partial \Pi}{\partial C_i} = \frac{\partial \Pi}{\partial a_i} = \frac{\partial \Pi}{\partial b_i} = 0 \quad (6)$$

From these equations, the non-coupled expressions of fractal quantization for the wavelength and ultimate speed are obtained as follows

$$\lambda_1(n) = \frac{47542.69}{n^{2.275455-0.1576265n}} \quad n = 3, 4, 5 \quad (27)$$

$$v_1^2(E_k) = \frac{7.353035}{E_k^{-0.2424636+0.03165919E_k}} \quad E_k = 1.1, 1.8, 4.7 \quad (28)$$

From Eqs.(27) and (28), it follows that $C_1 = 6466.7C_2$ and $a_0 = -9.385b_0$.

The results of Eqs.(27) and (28) are shown in Table 1 and Table 2, which agree with the experimental results completely.

Then we discuss the coupled solution. We let all constant terms in the quantum mechanics solution to be equal to those in the special relativity solution.

Namely, in Eqs.(22) and (24), we set

$$C_1 = C_2,$$

$$a_0 = b_0,$$

$$D_1 = a_0 + a_1n + a_2n^2,$$

$$D_2 = b_0 + b_1E_k + b_2E_k^2.$$

Solving Eqs.(26), the coupled expressions of fractal quantization for the wavelength and ultimate speed are obtained as follows

$$\lambda_1(n) = \frac{4.365727}{n^{-16.41046+4.489881n-0.4130926n^2}} \quad n = 3, 4, 5 \quad (29)$$

$$v_1^2(E_k) = \frac{4.365727}{E_k^{-16.41046+11.69979E_k-1.765917E_k^2}} \quad E_k = 1.1, 1.8, 4.7 \quad (30)$$

The results of Eqs.(29) and (30) are shown in Table 1 and Table 2, which again agree with the experimental results completely.

From the above results, we may see that, for problems of two completely different domains, such as quantum mechanics and special relativity, the extremely similar solutions can be obtained with the method presented in this paper. Moreover, although the coupled equation of quantum mechanics and special relativity has not been established, the coupled solution for the quantum mechanics and the theory of relativity can be obtained.

7. Further discussions

The unified variational principle of quantization in DSMS and the fractal quantization method can similarly be used for a unified treatment of problems in different domains, thus pave the way for a unified treatment of the theory of relativity and the quantum mechanics, and a unified treatment of the four fundamental interactions.

For example, we may discuss the simplest situation, namely, when the equations governing the four fundamental interactions are expressed by $F_i = 0$ ($i = 1, 2, 3, 4$). We may consider their action domains as a DSMS, assuming that all the coupled equations and supplementary contact and boundary conditions are expressed by $C_j = 0$. Then the variational principle for the unified treatment of the four foundational interactions may be expressed as

$$\Pi = \sum_{i=1}^4 W_i \int_{V_i} F_i^2 dV_i + \sum_1^j W_j \int_{V_j} C_j^2 dV_j = \min_0.$$

References

- [1] F.Smarandache, Mixed noneuclidean geometries, *eprint arXiv: math/0010119*, 10/2000.
- [2] F.Smarandache, A Unifying Field in Logics, *Neutrosophy: Neutrosophic Probability, Set, and Logic*, American research Press, Rehoboth, 1999.
- [3] L.F.Mao, *Smarandache multi-space theory*, Hexis, Phoenix, AZ, 2006.
- [4] Fu Yuhua, A unified variational principle of fluid mechanics and application on solitary subdomain or point, *China Ocean Engineering*, Vol.8, No.2(1994), 145-158.
- [5] Fu Yuhua, The application of optimum MWR in mechanics, physics and astronomy(in Chinese), in: *The advance and engineering application of the method of weighted residual*, Wuhan University Press, 1992.
- [6] Fu Yuhua, New solution for problem advance of Mercury's perihelion(in Chinese), *Acta Astronomica Sinica*, 30(4).
- [7] Fu Yuhua, A new way for solving boundary layer equations(in Chinese), *China Offshore Oil Gas (Engineering)*, 2(6).
- [8] Fu Yuhua, Unified water gravity wave theory and improved linear wave, *China Ocean Engineering*, 6(1).
- [9] Fu Yuhua, Variable dimension fractal in fluid mechanics(in Chinese), *Proceedings of second computational hydrodynamics conference*, Wuhan, 1993, 202-207.

Theory of Relativity on the Finsler Spacetime

Shenglin Cao

(Department of Astronomy of Beijing Normal University, Beijing 100875, P.R.China)

Email caosl20@yahoo.com.cn

Abstract: Einstein's theory of special relativity and the principle of causality imply that the speed of any moving object cannot exceed that of light in a vacuum (c). Nevertheless, there exist various proposals for observing faster-than- c propagation of light pulses, using anomalous dispersion near an absorption line, nonlinear and linear gain lines, or tunnelling barriers. However, in all previous experimental demonstrations, the light pulses experienced either very large absorption or severe reshaping, resulting in controversies over the interpretation. Recently, L.J.Wang, A.Kuzmich and A.Dogariu use gain-assisted linear anomalous dispersion to demonstrate superluminal light propagation in atomic caesium gas. The group velocity of a laser pulse in this region exceeds c and can even become negative, while the shape of the pulse is preserved. The textbooks say nothing can travel faster than light, not even light itself. New experiments show that this is no longer true, raising questions about the maximum speed at which we can send information. On the other hand, the light speed reduction to 17 meters per second in an ultracold atomic gas. This shows that the light speed could taken on voluntariness numerical value, This paper shows that if ones think of the possibility of the existence of the superluminal-speeds (the speeds faster than that of light) and redescribe the special theory of relativity following Einstein's way, it could be supposed that the physical spacetime is a Finsler spacetime, characterized by the metric

$$ds^4 = g_{ijkl}dx^i dx^j dx^k dx^l.$$

¹Supported by National Natural Science Foundation of China(Grant No.10371138)

If so, a new spacetime transformation could be found by invariant ds^4 and the theory of relativity is discussed on this transformation. It is possible that the Finsler spacetime $F(x, y)$ may be endowed with a catastrophic nature. Based on the different properties between the ds^2 and ds^4 , it is discussed that the flat spacetime will also have the catastrophe nature on the Finsler metric ds^4 . The spacetime transformations and the physical quantities will suddenly change at the catastrophe set of the spacetime, the light cone. It will be supposed that only the dual velocities of the superluminal-speeds could be observed. If so, a particle with the superluminal-speeds $v > c$ could be regarded as its anti-particle with the dual velocity $v_1 = c^2/v < c$. On the other hand, it could be assumed that the horizon of the field of the general relativity is also a catastrophic set. If so, a particle with the superluminal-speeds could be projected near the horizon of these fields, and the particle will move on the spacelike curves. It is very interesting that, in the Schwarzschild fields, the theoretical calculation for the spacelike curves should be in agreement with the data of the superluminal expansion of extragalactic radio sources observed year after year.(see Cao,1992b)

The catastrophe of spacetime has some deep cosmological means. According to the some interested subjects in the process of evolution of the universe the catastrophe nature of the Finsler spacetime and its cosmological implications are discussed. It is shown that the nature of the universal evolution could be attributed to the geometric features of the Finsler spacetime.(see Cao,1993)

Key words: Spacetime, catastrophe, Finsler metric, Finsler spacetime, speed faster than light .

It is known that in his first paper on the special theory of relativity: “On the electrodynamics of moving bodies”, Einstein clearly states (cf. Einstein, 1923) that ‘Velocities greater than that of light have, no possibility of existence.’ But he neglected to point out the applicable range of Lorentz transformation. In fact, his whole description must be based on velocities smaller than that of light which we call subluminal-speed. So, the special theory of relativity cannot negate that real motion at a speed greater than the speed of light in vacuum which we call superluminal-speed could exist. In this paper, it is shown that if we think of the possibility of existence of the superluminal-speed and redescribe the special theory of relativity following Einstein’s way, a new theory would be founded on the Finsler spacetime. The new theory would retain all meaning of the special theory of relativity when matters move with subluminal-speed and would give new content when matters move

with superluminal-speed. If we assume that the superluminal-speed will accord with the spacelike curves in the general theory of relativity, calculations indicate that the superluminal expansion of extragalactic radio sources exactly corresponds with the spacelike curves of the Schwarzschild geometry.

Our discussion is still based on the principle of relativity and on the principle of constancy of the velocity of light which have been defined by Einstein as follows:

(1)The laws by which the states of physical systems undergo change are not affected, whether these changes of state be referred to the one or the other of two systems of coordinates in uniform translatory motion (see Einstein, 1923;p.41).

(2)Any ray of light moves in the ‘stationary’ system of coordinates with the determined velocity c , whether the ray be emitted by stationary or by a moving body.

Note that these two postulates do not impose any constraint on the relative speed v of the two inertial observers.

§1. The general theory of the transformation of spacetime

1-1. Definition of simultaneity and temporal order

In his description about definition of simultaneity, Einstein stated: “Let us take a system of coordinates in which the equations of Newtonian mechanics hold good”, \dots , “Let a ray of light start at the ‘A time’ t_A from A towards B, let it at the B time’ t_B be reflected at B in the direction of A, and arrive again at A at the ‘A time’ t'_A .” In accordance with definition, the two clocks synchronize if (see Einstein, 1923; p.40)

$$t_B - t_A = t'_A - t_B. \quad (1.1)$$

“In agreement with experience we further assume the quantity

$$\frac{2AB}{t_B - t_A} = c, \quad (1.2)$$

to be a universal constant - the velocity of light in empty space.”

“It is essential to have time defined by means of stationary clocks in the stationary system, and the time now defined being appropriate to the stationary system we call it ‘the time of the stationary system’.” In this way, Einstein finished his definition of simultaneity. But he did not consider the applicable condition of this

definition, still less the temporal order and as it appears to me these discussions are essential too. Let us continue these discussions following Einstein's way.

First and foremost, let us assume if the point B is moving with velocity v relative to the point A, in agreement with experience we must use the following equations instead of Equation (2):

$$\frac{2AB}{t_A - t_B} = \begin{cases} c - v, & \text{when } B \text{ is leaving } A & (a) \\ c + v, & \text{when } B \text{ is approaching } A & (b) \end{cases} \quad (1.3)$$

Obviously, Equation (1.3a) is not always applicable, it must require $v < c$, but Equation (1.3b) is always applicable-i.e., for $v < c$ and $v > c$ Einstein's whole discussion is based on the following formulae:

$$t_B - t_A = \frac{r_{AB}}{c - v} \text{ and } t'_A - t_B = \frac{r_{AB}}{c + v}. \quad (1.4)$$

It must require $v < c$, because $t_B - t_A$ must be larger than zero. Particularly, in order to get the Lorentz transformation, Einstein was based on the following formula (see Einstein, 1923; p.44)

$$\frac{1}{2}[\tau(0, 0, 0, t) + \tau(0, 0, 0, t + \frac{x'}{c-v} + \frac{x'}{c+v})] = \tau(x', 0, 0, t + \frac{x'}{c-v}), \quad (1.5)$$

where $\frac{x'}{c-v}$ is just $t_B - t_A$, so must require $v < c$, i.e., B must be the motion with the subluminal-speed. Then the Lorentz transformation only could be applied to the motion with subluminal-speed. It could not presage anything about the motion with the superluminal-speed, i.e., the special theory of relativity could not negate that the superluminal-speed would exist.

In order for our discussion to be applied to the motion with the superluminal-speed, we will only use Equation (1.3b), i.e., let the point B approach A. Now, let another ray of light (it must be distinguished from the first) start at the 'A time' t_{A1} from A towards B (when B will be at a new place B_1) let it at the 'B time' t_{B1} be reflected at B in the direction of A, and arrive again at A at the 'A time' t_{A1} .

According to the principle of relativity and the principle of the constancy of the velocity of light, we obtain the following formulas:

$$\frac{1}{2}(t'_A - t_A) = t_B - t_A = \frac{AB}{c + v}, \quad (1.6)$$

$$\frac{1}{2}(t'_{A1} - t_{A1}) = t_{A1} - t_{B1} = \frac{AB_1}{c+v}, \quad (1.7)$$

$$AB - AB_1 = v(t_{A1} - t_A). \quad (1.8)$$

Let

$$\Delta t_A = t_{A1} - t_A, \Delta t_B = t_{B1} - t_B \quad \text{and} \quad \Delta t'_A = t'_{A1} - t'_A, \quad (1.9)$$

where $\Delta t_A, \Delta t_B$, and $\Delta t'_A$ represent the temporal intervals of the emission from A, the reflection from B, and arrival at A for two rays of light, respectively. The symbols of the temporal intervals describe the temporal orders. When $\Delta t > 0$ it will be called the forward order and when $\Delta t < 0$, the backward order.

From Equations (1.6)-(1.9) we can get

$$\Delta t_B = \frac{c}{c+v} \Delta t_A, \quad (1.10)$$

and

$$\Delta t'_A = \frac{c-v}{c+v} \Delta t_A. \quad (1.11)$$

Then we assume that, if $\Delta t_A > 0$, i.e., two rays of light were emitted from A, successively we must have $\Delta t_B > 0$ i.e., for the observer at system A these two rays of light were reflected by the forward order from B. But

$$\Delta t'_A \geq 0, \text{ if and only if } v \leq c$$

and

$$\Delta t'_A < 0, \text{ if and only if } v > c.$$

It means that for the observer at system A these two rays of light arrived at A by the forward order only when the point B moves with subluminal-speed, and by the backward order only when with superluminal-speed. In other words, the temporal order is not always constant. It is constant only when $v < c$, and it is not constant when $v > c$.

Usually, one thinks that this is a backward flow of time. In fact, it is only a procedure of time in the system B with the superluminal-speed which gives the

observer in the ‘stationary system’ A an inverse appearance of the procedure of the time. It is an inevitable outcome when the velocity of the moving body is faster than the transmission velocity of the signal. This outcome will be called the relativity of the temporal order. It is a new nature of the time when the moving body attains the supeluminal-speed. It is known that it is not spacetime that impresses its form on things, but the things and their physical laws that determine spacetime. So, the superluminal-speed need not be negated by the character of the spacetime of the special theory of relativity, but will represent the new nature of the spacetime, the relativity of the temporal order.

1-2. The temporal order and the chain of causation

In order to explain the disparity between the backward flow of time and the relativity of the temporal order, we will use spacetime figure (as Fig.1-1)

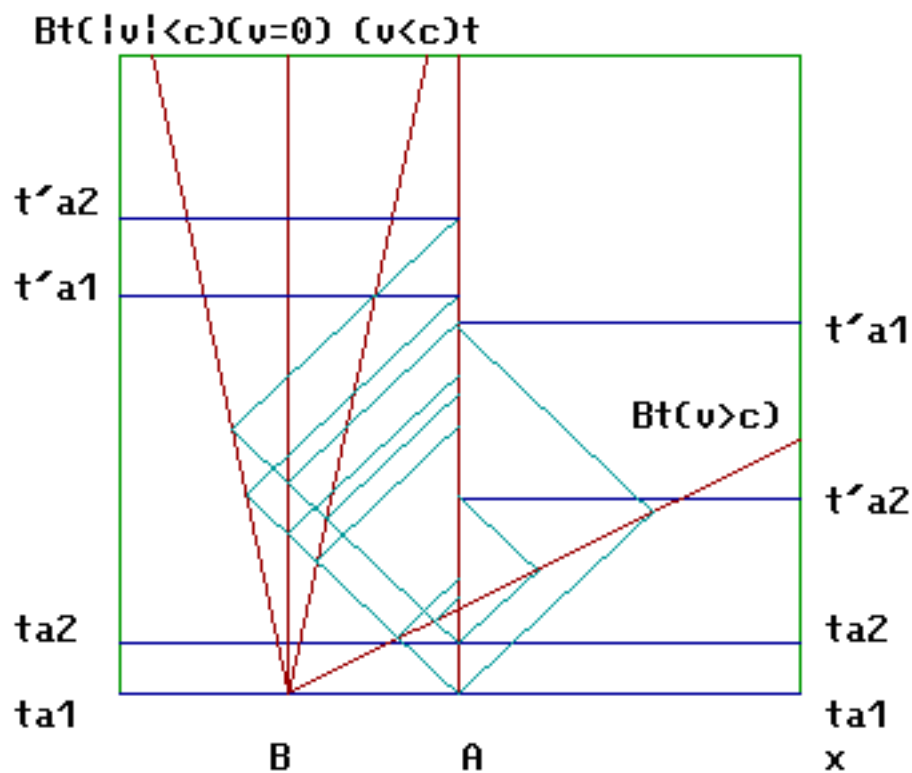

Fig.1-1. The spacetime figure

and take following definitions.

(1)The chain of the event, $t_{A0}, t_{A1}, \dots, t_{Ai}, \dots$. The i th ray of light will be started at t_{Ai} and $\Delta t_{Ai} = t_{A(i+1)} - t_{Ai} > 0$ It may or may not be chain of causality.

(2)The chains of the transference of the light $t_{A0}, t_{B0}, t'_{A0}; t_{A1}, t_{B1}, t'_{A1}; \dots$. Every chain t_{Ai}, t_{Bi}, t'_{Ai} must be a chain of causality -i.e.

$$\frac{1}{2}(t'_{Ai} - t_{Ai}) = t_{Bi} - t_{Ai} = t'_{Ai} - t_{Bi} > 0. \quad (1.12)$$

If they take a negative sign it will be the backward flow of time and will violate the principle of causality.

(3)The chains of the motion are the rays of the light, which will be reflected at B, but it will have different features when B moves with different velocity. Let us assume that:

- (a) $v > 0$ when B is approaching A;
- (b) $v < 0$ when B is leaving A;
- (c) $c > 0$ when the ray of light from A backwards B;
- (d) $c < 0$ when the ray of light from A towards B.

So, if $v=0$, we must have $c < 0$. Then

$$t_{A(i+1)} - t_{Ai} = t_{B(i+1)} - t_{Bi} = t'_{A(i+1)} - t'_{Ai}. \quad (1.13)$$

If $v < c$, we must have $c < 0$ and when $v > 0$,

$$t_{A(i+1)} - t_{Ai} > t_{B(i+1)} - t_{Bi} > t'_{A(i+1)} - t'_{Ai} > 0. \quad (1.14)$$

But when $v < 0$,

$$0 < t_{A(i+1)} - t_{Ai} < t_{B(i+1)} - t_{Bi} < t'_{A(i+1)} - t'_{Ai}. \quad (1.15)$$

Last of all, if $v > c$, must have $v > 0$; and when $c < 0$,

$$t_{A(i+1)} - t_{Ai} > t_{B(i+1)} - t_{Bi} > |t'_{A(i+1)} t'_{Ai}| > 0. \quad (1.16)$$

But

$$t'_{A(i+1)} - t'_{Ai} < 0. \quad (1.17)$$

When $c > 0$,

$$0 < t_{A(i+1)} - t_{Ai} < |t_{B(i+1)} - t_{Bi}| < |t'_{A(i+1)} - t'_{Ai}| \quad (1.18)$$

and

$$t_{B(i+1)} - t_{Bi} < 0 \quad \text{and} \quad t'_{A(i+1)} - t_{Ai} < 0. \quad (1.19)$$

These are rigid relations of causality.

4. The chains of the observation $t'_{A0}, t'_{A1}, \dots, t'_{Ai}, \dots$ and $t_{B0}, t_{B1}, \dots, t_{Bi}, \dots$ are not chains of causality. The relativity of temporal order is just that they could be a positive when $v < c$ or a negative when $v > c$ and the vector v and c have the same direction.

In (1.4) when $v > c$, $t_B - t_A < 0$ it does not mean that velocities greater than that of light have no possibility of existence but only that the ray of light cannot catch up with the body with superluminal-speed.

1-3. Theory of the Transformation of Coordinates

From equations (1.10) and (1.11) we can get

$$\Delta t_B = \frac{c}{c+v} \Delta t_A \quad (1.20)$$

and

$$\Delta t_B = \frac{c}{c-v} \Delta t'_A. \quad \text{quad} \quad (1.21)$$

It has been pointed out that Δt_A and $\Delta t'_A$ are measurable by observer of the system A, but Δt_B is unmeasurable. Accordingly, the observer must conjecture Δt_B from Δt_A or $\Delta t'_A$. In form, Δt_B in Equation (1.20) and Δt_B in (1.21) are different. If we can find a transformation of coordinates it will satisfy following equation:

$$\Delta \tau^2 = \Delta t_A \cdot \Delta t'_A \quad (1.22)$$

and, according to Equations (1.10) and (1.11), could get

$$\Delta \tau^2 = \begin{cases} > 0, & \text{iff } v < c, \\ = 0, & \text{iff } v = c, \\ < 0, & \text{iff } v > c. \end{cases} \quad (1.23)$$

Then, we get

$$\Delta t_B^2 = \frac{c^2}{c^2 - v^2} \Delta \tau^2$$

or

$$dt^2 = \frac{c^2}{c^2 - v^2} d\tau^2. \quad (1.24)$$

Let $ds^2 = c^2 d\tau^2$. We get

$$ds^2 = c^2 d\tau^2 = (c^2 - v^2) dt^2. \quad (1.25)$$

So

$$ds^2 = \begin{cases} > 0, & v < c \text{ timelike,} \\ = 0, & v = c \text{ lightlike,} \\ < 0, & v > c \text{ spacelike.} \end{cases} \quad (1.26)$$

What merits special attention is that $ds^2 = (c^2 - v^2) dt^2$ and $ds^2 = c^2 dt^2 - dx^2 - dy^2 - dz^2$ are not identical. Usually, the special theory of relativity does not recognize their difference because motion with subluminal-speed does not involve the relative change of temporal orders, so the symbol of ds^2 remains unchanged when the inertial system changes.

Now let

$$ds^2 = ds_v^2 + ds_0^2, \quad (1.27)$$

where

$$ds_v^2 = (c^2 - v^2) dt^2, \quad (1.28)$$

$$ds_0^2 = dx^2 + dy^2 + dz^2, \quad (1.29)$$

then

$$ds^2 = \begin{cases} +ds_v^2 + ds_0^2, & v < c, \\ -ds_v^2 + ds_0^2, & v > c. \end{cases} \quad (1.30)$$

Between any two inertial systems

$$ds_v^2 + ds_0^2 = \begin{cases} +ds_v^2 + ds_0^2, & v < c, \\ -ds_v^2 + ds_0^2, & v > c. \end{cases} \quad (1.31)$$

According to classical mechanics, we can determine the state of a system with n degrees of freedom at time t by measuring the $2n$ position and momentum coordinates $q^i(t)$, $p_i(t)$, $i=1,2,\dots,n$. These quantities are commutative each other, i.e., $q^i(t) p_j(t) = p_j(t) q^i(t)$. But, in quantum mechanics the situation is entirely different. The operators Q_{op} and P_{op} corresponding to the classical observable position vector q and momentum vector p . These operators are non-commutative each other, i.e.,

$$QP \neq PQ.$$

So, ones doubt whether the quantum mechanics is not a good theory at first. But, ones discover that the non-commutability of operators is closely related to the uncertainty principle, it is just an essential distinction between the classical and quantum mechanics.

So, I doubt that whether the non-positive definite metrics ds^2 is just the best essential nature in the relativity theory? But, it was cast aside in Einstein's theory. Now, we could assume that

$$ds^4 = ds_v^4 + ds_0^4. \quad (1.32)$$

In general, we could let

$$ds^4 = g_{ijkl} dx^i dx^j dx^k dx^l, \quad i, j, k, l = 0, 1, 2, 3. \quad (1.33)$$

Equations (1.32) and (1.33) which are defined as a Finsler metric are the base of the spacetime transformations. From the physical point of view this means that a new symmetry between the timelike and the spacelike could exist.

In his memoir of 1854, Riemann discusses various possibilities by means of which an n -dimensional manifold may be endowed with a metric, and pays particular attention to a metric defined by the positive square root of positive definite quadratic differential form. Thus the foundations of Riemannian geometry are laid; nevertheless, it is also suggested that the positive fourth root of a fourth-order differential form might serve as metric function (see Rund, 1959; Introduction X).

In his book of 1977, Wolfgang Rindler stated: "Whenever the squared differential distance $d\sigma^2$ is given by a homogeneous quadratic differential form in the surface coordinates, as in (7.10), we say that $d\sigma^2$ is a Riemannian metric, and that the corresponding surface is Riemannian. It is, of course, not a foregone conclusion that all metrics must be of this form: one could define, for example, a non-Riemannian

metric $d\sigma^2 = \sqrt{dx^4 + dy^4}$ for some two-dimensional space, and investigate the resulting geometry. (Such more general metrics give rise to ‘Finsler’ geometry.)” (see W. Rindler, 1997).

§2. The Special Theory of Relativity on the Finsler Spacetime ds^4

2-1 Spacetime Transformation Group on the Finsler Metric ds^4

If $v = v_x$, then, between any two inertial systems we have

$$\begin{aligned} c^4 dt^4 + dx^4 - 2c^2 dt^2 dx^2 + dy^4 + dz^4 + 2dy^2 dz^2 \\ = c^4 dt'^4 + dx'^4 - 2c^2 dt'^2 + dy'^4 + dz'^4 + 2dy'^2 dz'^2 \end{aligned} \quad (2.1)$$

From (2.1) we could get transformations

$$t = \frac{t' + \frac{v}{c^2}x'}{\sqrt[4]{1 - 2\beta^2 + \beta^4}}, \quad x = \frac{x' + vt'}{\sqrt[4]{1 - 2\beta^2 + \beta^4}}, \quad y = y', \quad z = z'. \quad (2.2)$$

These transformations are called spacetime transformations. All spacetime transformations form into a group, called the spacetime transformation group (The Lorentz transformations group is only subgroup of the spacetime transformation group). The inverse transformations are of the form

$$\pm t' = \frac{t - \beta \frac{x}{c}}{\sqrt[4]{1 - 2\beta^2 + \beta^4}}, \quad \pm x' = \frac{x - vt}{\sqrt[4]{1 - 2\beta^2 + \beta^4}}, \quad y' = y, \quad z' = z, \quad (2.3)$$

where $\beta = \frac{v}{c}$. We could also use dual velocity $v_1 = \frac{c^2}{v}$ to represent the spacetime transformations. In fact, the transformations (2.2) can be rewritten as

$$t = \frac{\beta_1 t' + \frac{x'}{c}}{\sqrt[4]{1 - 2\beta_1^2 + \beta_1^4}}, \quad x = \frac{\beta_1 x' + ct'}{\sqrt[4]{1 - 2\beta_1^2 + \beta_1^4}}, \quad y = y', \quad z = z'. \quad (2.4)$$

Their inverse transformations are of the form

$$\pm t' = \frac{\beta_1 t - \frac{x}{c}}{\sqrt[4]{1 - 2\beta_1^2 + \beta_1^4}}, \quad \pm x' = \frac{\beta_1 x - ct}{\sqrt[4]{1 - 2\beta_1^2 + \beta_1^4}}, \quad y' = y, \quad z' = z. \quad (2.5)$$

where $\beta_1 = \frac{v_1}{c} = \frac{c}{v} = \frac{1}{\beta}$.

It is very interesting that all spacetime transformations are applicable to both the subluminal-speed (i.e., $\beta < 1$ or $\beta_1 > 1$) and the superluminal-speed (i.e., $\beta > 1$ or

$\beta_1 < 1$). Whether the velocity is superluminal- or subluminal-speed, it is characterized by minus or plus sign of their inverse transformations, respectively.

Lastly, all spacetime transformations have the same singularity as the Lorentz transformation when the $\beta = \beta_1 = 1$.

2-2. Kinematics on the ds^4 Invariant

We shall now consider the question of the measurement of length and time increment. In order to find out the length of a moving body, we must simultaneously plot the coordinates of its ends in a fixed system. From Equation (2.2) and (2.4), an expression for the length of a moving scale $\Delta x'$ measured by a fixed observer follows as

$$\pm \Delta x' = \Delta x \sqrt[4]{1 - 2\beta^2 + \beta^4}, \quad (2.6)$$

and

$$\pm \Delta x' = c\Delta t \sqrt[4]{1 - 2\beta_1^2 + \beta_1^4}, \quad (2.7)$$

Einstein stated: “For $v = c$ all moving objects - viewed from the ‘stationary’ system - shrivel up into plain figures. For velocities greater than that of light our deliberations become meaningless.” However, formula (2.6) can be applied to the case for velocities greater than that of light. Fig.2.1 gives the relation between the length of a moving scale L and the velocity.

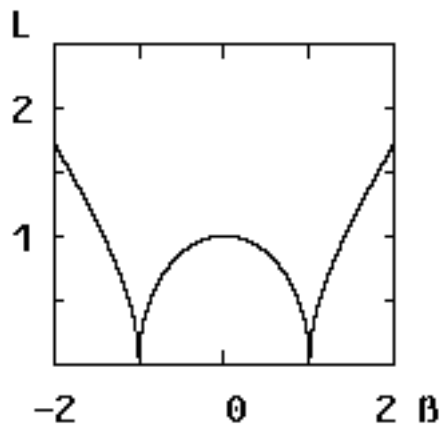

Fig.2.1. L - β curve

Let Δt be the time increment when the clock is at rest with respect to the stationary system, and $\Delta\tau$ be the time increment when the clock is at rest with

respect to the moving system. Then

$$\pm\Delta\tau = \Delta t \sqrt[4]{1 - 2\beta^2 + \beta^4} \quad (2.8)$$

and

$$\pm\Delta\tau = \frac{\Delta x}{c} \sqrt[4]{1 - 2\beta_1^2 + \beta_1^4}, \quad (2.9)$$

Differentiating (2.3) or (2.5) and dividing dx' by dt' we obtain

$$\frac{dx'}{dt'} = v'_x = \frac{dx/dt - v}{1 - v/c^2 dx/dt} = \frac{v_x - v}{1 - vv_x/c^2}, \quad (2.10)$$

Noting that $dy' = dy$, $dz' = dz$, we have a transformation of the velocity components perpendicular to v :

$$\frac{dy'}{dt'} = v'_y = \frac{v_y \sqrt[4]{1 - 2\beta^2 + \beta^4}}{1 - vv_x/c^2}, \quad \frac{dz'}{dt'} = v'_z = \frac{v_z \sqrt[4]{1 - 2\beta^2 + \beta^4}}{1 - vv_x/c^2}, \quad (2.11)$$

where

$$v^2 = v_x^2 + v_y^2 + v_z^2. \quad (2.12)$$

From Equation (2.8), we could see that the composition of velocities have four physical implications: i.e.,

(1) A subluminal-speed and another subluminal-speed will be a subluminal-speed.

(2) A superluminal-speed and a subluminal-speed will be a superluminal-speed.

(3) The composition of two superluminal-speeds is a subluminal-speed.

(4) The composition of light-speed with any other speed (subluminal-, light-, or superluminal-speed) still is the light-speed.

There are the essential nature of the spacetime transformation group. The usual Lorentz transformation is a only subgroup of the spacetime transformation group.

It is necessary to point out that if $1 - vv_x/c^2 = 0$, i.e.,

$$v_x = v/c^2, \quad (2.13)$$

then $v_x \rightarrow \infty$. It implies that if two velocities are dual to each other and in opposite directions, then their composition velocity is an infinitely great velocity. We guess that it may well become an effective way to make an appraisal of a particle with the superluminal-speed.

2-3. Dynamics on the ds^4 Invariant

The Lagrangian for a free particle with mass m is

$$L = -mc^2 \sqrt[4]{1 - 2\beta^2 + \beta^4}, \quad (2.14)$$

The momentum energy, and mass of motion of the particle are of the forms:

$$p = \frac{mv}{\sqrt[4]{1-2\beta^2+\beta^4}}, E = \frac{mc^2}{\sqrt[4]{1-2\beta^2+\beta^4}}, M = \frac{m}{\sqrt[4]{1-2\beta^2+\beta^4}}. \quad (2.15)$$

Those could also be represented by dual velocity v_1 :

$$p(v) = \frac{mv}{\sqrt[4]{1-2\beta^2+\beta^4}} = \frac{mc}{\sqrt[4]{1-2\beta_1^2+\beta_1^4}} = \frac{1}{c}E(v_1), \quad (2.16)$$

$$E(v) = \frac{mc^2}{\sqrt[4]{1-2\beta^2+\beta^4}} = \frac{mv_1c}{\sqrt[4]{1-2\beta_1^2+\beta_1^4}} = cp(v_1), \quad (2.17)$$

$$M(v) = \frac{m}{\sqrt[4]{1-2\beta^2+\beta^4}} = \frac{\beta_1 m}{\sqrt[4]{1-2\beta_1^2+\beta_1^4}} = \beta_1 M(v_1). \quad (2.18)$$

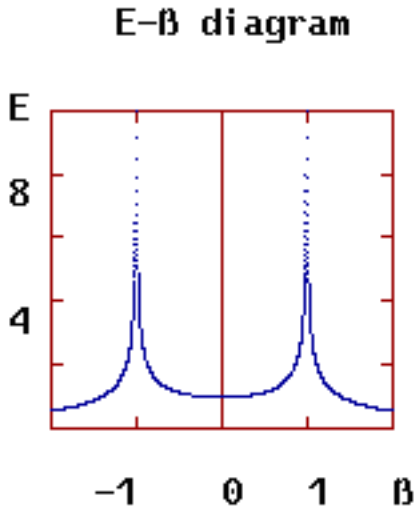

Fig.2.2. E- β diagram

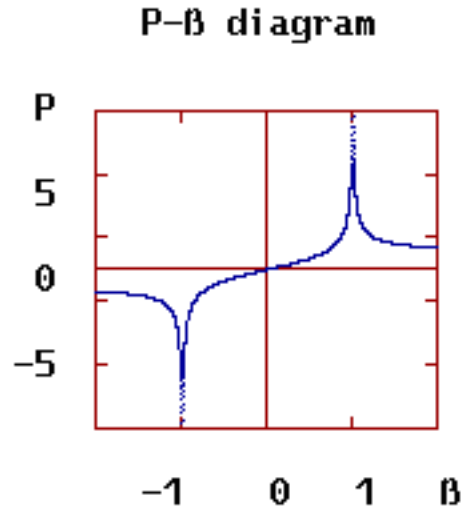

Fig. 2.3. p- β diagram

Einstein stated: “Thus, when $v = c$, E becomes infinite, velocities greater than that of light have - as in our previous results - no possibility of existence.” But, formula (2.7) can also applied to the case for velocities greater than that of light. Fig.2.2 give the relation between the energy of a moving particle and its velocity,

and Fig.2.3 give the relation between the momentum of a moving particle and its velocity.

It is very interesting that the momentum (or energy) in the v 's representation will change into the energy (or momentum) in the v_1 's representation. From (2.15) (or (2.16) and (2.17)), we could get the following relation between the momentum and energy of a free material particle:

$$p(v) = \frac{v}{c^2}E(v) \quad \text{or} \quad p(v_1) = \frac{v_1}{c^2}E(v_1), \quad (2.19)$$

where the relation (2.19) keeps up the same form as the special theory of relativity. But a new invariant will be obtained as

$$E^4 + c^4 p^4 - 2c^2 p^2 E^2 = m^4 c^8. \quad (2.20)$$

The relation (2.20) is correct for both of the v 's and the v_1 's representations. It is a new relation on the ds^4 invariant.

2.4. A Charged Particle in an Electromagnetic Field on the Finsler Spacetime ds^4

Let us now turn to the equations of motion for a charged particle in an electromagnetic field, A, Φ, E_e and H_e . Their Lagrangian is

$$L = -mc^2 \sqrt[4]{1 - 2\beta^2 + \beta^4} + \frac{e}{c}Av - e\Phi. \quad (2.21)$$

The derivative $\partial L/\partial v$ is the generalized momentum of the particle. We denote it by p_e

$$p_e = mv \sqrt[4]{1 - 2\beta^2 + \beta^4} + \frac{e}{c}A = p + \frac{e}{c}A. \quad (2.22)$$

where p denotes momentum in the absence of a field.

From the Lagrangian we could find the Hamiltonian function for a particle in a field from the general formula

$$H = mc^2 \sqrt[4]{1 - 2\beta^2 + \beta^4} + e\Phi. \quad (2.23)$$

However, the Hamiltonian must be expressed not in terms of the velocity, but rather in terms of the generalized momentum of the particle. From equations (2.2) and (2.3), we can get the relation

$$\left[\left(\frac{H - e\Phi}{c}\right)^2 - \left(p - \frac{e}{c}A\right)^2\right]^2 = m^4 c^4. \quad (2.24)$$

Now we write the Hamilton-Jacobi equation for a particle in an electromagnetic field in the Finsler spacetime. It is obtained by replacing, in the equation for the Hamiltonian, P by $\partial S/\partial r$, and H by $-\partial S/\partial t$. Thus we get from (2.24)

$$\left[(\nabla S - \frac{e}{c}A)^2 - \frac{1}{c^2}\left(\frac{\partial S}{\partial t} + e\Phi\right)^2\right]^2 - m^4 c^4 = 0. \quad (2.25)$$

Now we consider the equation of motion of a charge in an electromagnetic field. It could be written by Lagrangian (2.21) as

$$\frac{d}{dt} \frac{mv}{\sqrt[4]{1 - 2\beta^2 + \beta^4}} = eE_e + \frac{e}{c}v \times H_e. \quad (2.26)$$

where

$$E_e = -\frac{1}{c} \frac{\partial A}{\partial t} - \text{grad}\Phi, \quad H_e = \text{curl}A. \quad (2.27)$$

It is easy to check the $dE_e = v dP$, i.e.,

$$v \frac{d}{dt} \frac{mv}{\sqrt[4]{1 - 2\beta^2 + \beta^4}} = mc^2 \frac{d}{dt} \frac{1}{\sqrt[4]{1 - 2\beta^2 + \beta^4}}. \quad (2.28)$$

Then from (2.26) we have

$$\frac{dE}{dt} = eE_e v. \quad (2.29)$$

Integrate (2.29) and get

$$\frac{mc^2}{\sqrt[4]{1 - 2\beta^2 + \beta^4}} - \frac{mc^2}{\sqrt[4]{1 - 2\beta_0^2 + \beta_0^4}} = eU. \quad (2.30)$$

where

$$\beta_0 = \frac{v_0}{c}, \quad U = \int_{r_0}^r E_e dr. \quad (2.31)$$

From (2.26) and (2.29), if we write it in terms of components, it is easy to obtain the spacetime transformation equations for the field components, and we could obtain the field transformation equation

$$\left\{ \begin{array}{ll} H'_x = H_x, & E'_x = E_x, \\ H'_y = \frac{H_y + \beta E_z}{\sqrt[4]{1 - 2\beta^2 + \beta^4}}, & E'_y = \frac{E_y - \beta H_z}{\sqrt[4]{1 - 2\beta^2 + \beta^4}}, \\ H'_z = \frac{H_z - \beta E_y}{\sqrt[4]{1 - 2\beta^2 + \beta^4}}, & E'_z = \frac{E_z + \beta H_y}{\sqrt[4]{1 - 2\beta^2 + \beta^4}}. \end{array} \right. \quad (2.32)$$

We could also use dual velocity v_1 to represent the field transformation equation

$$\left\{ \begin{array}{ll} H'_x = H_x, & E'_x = E_x, \\ H'_y = \frac{\beta_1 H_y + E_z}{\sqrt[4]{1 - 2\beta_1^2 + \beta_1^4}}, & E'_y = \frac{\beta_1 E_y - H_z}{\sqrt[4]{1 - 2\beta_1^2 + \beta_1^4}}, \\ H'_z = \frac{\beta_1 H_z - E_y}{\sqrt[4]{1 - 2\beta_1^2 + \beta_1^4}}, & E'_z = \frac{\beta_1 E_z + H_y}{\sqrt[4]{1 - 2\beta_1^2 + \beta_1^4}}. \end{array} \right. \quad (2.33)$$

An invariant will be obtained as

$$H_e^4 + E_e^4 - 2H_e^2 E_e^2 = \text{constant},$$

of new nature for the electromagnetic field in Finsler spacetime.

§3. The Catastrophe of the Spacetime and Its Physical Meaning

3.1. Catastrophe of the Spacetime on the Finsler Metric ds^4

The functions $y = x^2$ and $y = x^4$ are topologically equivalent in the theory of the singularities of differentiable maps (see Arnold et al., 1985). But the germ $y = x^2$ is topologically (and even differentially) stable at zero. the germ $y = x^4$ is differentially (and even topologically) unstable at zero. So, there is a great difference between the theories of relativity on the ds^2 and the ds^4 .

On the other hand, a great many of the most interesting macroscopic phenomena in nature involve discontinuities. The Newtonian theory and Einstein's relativity theory only consider smooth, continuous processes. The catastrophe theory, however, provides a universal method for the study of all jump transitions, discontinuities and sudden qualitative changes. The catastrophe theory is a program. The object of this program is to determine the change in the solutions to families of equations when the parameters that appear in these equations change.

In general, a small change in parameter values only has a small quantitative effect on the solutions of these equations. However, under certain conditions a small change in the value of some parameters has a very large quantitative effect on the solutions of these equations. Large quantitative changes in solutions describe qualitative changes in the behaviour of the system modeled.

Catastrophe theory is, therefore, concerned with determining the parameter

values at which there occur qualitative changes in solutions of families of equations described by parameters.

The double-cusp is the simplest non-simple in the sense of Arnold (see Arnold et al.,1985), but the double-cusp is unimodal.

The double-cusp is compact, in the sense that the sets $f \leq \text{constant}$ are compact. In Arnold's notation, the double-cusp belongs to the family X9 and in that family there are three real types of germ, according as to whether the germ has 0,2, or 4 real roots. For example representatives of the three types are: type $1x^4 + y^4$, type $2x^4 - y^4$, type $3x^4 + y^4 - 2\delta x^2 y^2$, respectively, and only the type 1 is compact.

Compact germs play an important role in application (see Zeeman, 1977), because any perturbation of a compact germ has a minimum; therefore if minima represent the stable equilibria of some system, then for each point of the unfolding space there exists a stable state of the system.

3.2. Catastrophe of the spacetime on the Finsler Metric ds^4

In accordance with the Finsler metric ds^4 of the spacetime, we could

$$f(T, X, Y, Z) = T^4 + X^4 + Y^4 + Z^4 - 2T^2X^2 + 2Y^2Z^2, \quad (3.1)$$

here $T=ct$. Equation (3.1) that describes the behaviour of the spacetime is a smooth function.

As the catastrophe theory, first we must find the critical points of this function. Let $f = 0$, and $f' = 0$, here $f' = \partial f / \partial s, s = T, X, Y, Z$. i.e.,

$$\begin{aligned} f &= T^4 + X^4 + Y^4 + Z^4 - 2T^2X^2 + 2Y^2Z^2 = 0, \\ f'_T &= \partial f / \partial T = 4T(T^2 - X^2) = 0, \\ f'_X &= \partial f / \partial X = 4X(X^2 - T^2) = 0, \\ f'_Y &= \partial f / \partial Y = 4Y(Y^2 + Z^2) = 0, \\ f'_Z &= \partial f / \partial Z = 4Z(Z^2 + Y^2) = 0. \end{aligned}$$

So, the critical point are

$$X = \pm T, \quad T = X = Y = Z = 0.$$

Then, we form the stability matrix $(\partial^2 f / \partial x^i \partial x^j)$. It is of the form

$$H(T, X, Y, Z) = \begin{bmatrix} 12T^2 - 4x^2 & -8Tx & 0 & 0 \\ -8Tx & 12x^2 - 4T^2 & 0 & 0 \\ 0 & 0 & 12y^2 + 4z^2 & 8yz \\ 0 & 0 & 8yz & 12z^2 + 4y^2 \end{bmatrix}.$$

Obviously, for the submatrix

$$H(Y, Z) = \begin{pmatrix} 12y^2 + 4z^2 & 8yz \\ 8yz & 12z^2 + 4y^2 \end{pmatrix},$$

its determinant does not vanish, unless $Y=Z=0$.

With the Thom theorem (splitting lemma), we could get

$$f_M(Y, Z) = Y^4 + Z^4 + 2Y^2Z^2, \quad (3.2)$$

$$f_{NM}(T, X) = T^4 + X^4 - 2T^2X^2, \quad (3.3)$$

where f_M Morse function, can be reduced to the Morse canonical form

$$M_0^2 = Y^2 + Z^2,$$

and f_{NM} , non-Morse function, is a degenerate form of the double-cusp catastrophe (see Zeeman, 1977). For another submatrix of $H(T, X, Y, Z)$

$$H(T, X) = \begin{vmatrix} 12T^2 - 4X^2 & -8TX \\ -8XT & 12X^2 - 4T^2 \end{vmatrix} = -48(T^4 + X^4 - 2T^2X^2).$$

So, the spacetime submanifold $M(T, X)$ will be divided into four parts by the different values of the $H(T, X)$:

$$\begin{array}{llll} H(T, X) \neq 0 & T^2 - X^2 < 0 & \textit{spacelike} & \textit{state} \\ (\textit{material states}) & T^2 - X^2 > 0 & \textit{timelike} & \textit{state} \\ H(T, X) = 0 & T = \pm X & \textit{lightlike} & \textit{state} \\ (\textit{singularities}) & T = X = 0 & \textit{the origin} & (\textit{indeterminate}). \end{array} \quad (3.4)$$

It means that the light cone is just a catastrophe set on the spacetime manifold, and both the timelike state and spacelike state are possible states of moving particles.

So, from the point of view of the catastrophe theory, the light cone is just a set of degenerate critical points on the spacetime manifold. The spacetime is structurally unstable at the light cone. It means that a lightlike state could change suddenly into a timelike state and a spacelike state. Also, a timelike state and a spacelike state could change suddenly into a lightlike state. It very much resembles the fact that two photons with sufficient energy could change suddenly into a pair of a particle and an anti-particle and contrarily, a pair of a particle and an antiparticle could annihilate and change into two photons.

According to the nature of catastrophe of the spacetime, the spacetime transformations (2.2) could be resolved into two parts at the light cone:

$$t = \frac{t' + \frac{\beta}{c}x'}{\sqrt{1 - \beta^2}}, x = \frac{x' + vt'}{\sqrt{1 - \beta^2}}, y = y', z = z'; \quad \beta = \frac{v}{c} < 1. \quad (3.5)$$

and

$$t = \frac{t' + \frac{\beta}{c}x'}{\sqrt{\beta^2 - 1}}, x = \frac{x' + vt'}{\sqrt{\beta^2 - 1}}, y = y', z = z'; \quad \beta = \frac{v}{c} > 1. \quad (3.6)$$

In the same way, the transformation (2.4) could also be resolved into two parts at the light cone:

$$t = \frac{\beta_1 t' + \frac{1}{c}x'}{\sqrt{\beta_1^2 - 1}}, x = \frac{\beta_1 x' + ct'}{\sqrt{\beta_1^2 - 1}}, y = y', z = z'; \quad \beta_1 = \frac{v_1}{c} > 1. \quad (3.7)$$

and

$$t = \frac{\beta_1 t' + \frac{1}{c}x'}{\sqrt{1 - \beta_1^2}}, x = \frac{\beta_1 x' + ct'}{\sqrt{1 - \beta_1^2}}, y = y', z = z'; \quad \beta_1 = \frac{v_1}{c} < 1. \quad (3.8)$$

It is very interesting that transformations (3.5) and (3.7) have two major features: Firstly, they keep the same sign between the ds^2 and the ds'^2 ; i.e.,

$$ds_v^2 = ds'_v{}^2. \quad (3.9)$$

Secondly, their inverse transformations are of the form

$$t' = \frac{t - \frac{\beta}{c}x}{\sqrt{1 - \beta^2}}, x' = \frac{x - vt}{\sqrt{1 - \beta^2}}, y' = y, z' = z; \quad \beta < 1. \quad (3.10)$$

and

$$t' = \frac{\beta_1 t - \frac{1}{c}x}{\sqrt{\beta_1^2 - 1}}, x' = \frac{\beta_1 x - ct}{\sqrt{\beta_1^2 - 1}}, y' = y, z' = z; \quad \beta_1 > 1. \quad (3.11)$$

These transformations keep the same sign between x, t and x', t' . So, they will be called the timelike transformations and (3.5) will be called the timelike representation of the timelike transformation (TRTT), and (3.7) the spacelike representation of timelike transformation (SRTT).

In the same manner, transformations (3.6) and (3.8) have two common major features, too. Firstly, they will change the sign between ds^2 and ds'^2 , i.e.,

$$-ds_v^2 = ds'_v{}^2. \quad (3.12)$$

Secondly, their inverse transformations are of the form

$$-t' = \frac{t - \frac{\beta}{c}x}{\sqrt{\beta^2 - 1}}, -x' = \frac{x - vt}{\sqrt{\beta^2 - 1}}, y' = y, z' = z; \quad \beta > 1. \quad (3.13)$$

and

$$-t' = \frac{\beta_1 t - \frac{1}{c}x}{\sqrt{1 - \beta_1^2}}, -x' = \frac{\beta_1 x - ct}{\sqrt{1 - \beta_1^2}}, y' = y, z' = z; \quad \beta_1 < 1. \quad (3.14)$$

These transformations will change the sign between x, t and x', t' . They will be called the spacelike transformations and (3.6) will be called the spacelike representation of spacelike transformation (SRST); and (3.8) the timelike representation of spacelike transformation (TRST).

Now, we have had four types of form of the spacetime transformation under ds^2 :

Type I. TRTT, (3.5), it is just the Lorentz transformation;

Type II. SRTT, (3.7), it is the spacelike representation of the Lorentz transformation with the dual velocity $v_1 = c^2/v$, it is larger than the velocity of light;

Type III. SRST, (3.6), it is just the superluminal Lorentz transformation (see Recami, 1986 and Sen Gupta, 1973);

Type IV. TRST, (3.8), it is the timelike representation of the superluminal Lorentz transformation with the dual velocity $v_1 = c^2/v$, but it is less than the velocity of light.

3-3. The Catastrophe of Physical Quantities on the Finsler Metric ds^4

Firstly, we shall consider the question of the catastrophe of the measurement of length and time increment. According to the nature of catastrophe of spacetime, the expression for the length of a moving scale $\Delta x'$ measured by a fixed observer (2.6)-(2.9) could be resolved into two parts,

$$\Delta x' = \Delta x \sqrt{1 - \beta^2}, \quad \beta < 1. \quad (3.15)$$

$$-\Delta x' = \Delta x \sqrt{\beta^2 - 1}, \quad \beta > 1. \quad (3.16)$$

$$-\Delta x' = c\Delta t \sqrt{1 - \beta_1^2}, \quad \beta_1 < 1. \quad (3.17)$$

$$\Delta x' = c\Delta t \sqrt{\beta_1^2 - 1}, \quad \beta_1 > 1. \quad (3.18)$$

The expression for the time increment $\Delta\tau$ of the clock at rest with respect to the moving system could be resolved into two parts at the light cone:

$$\Delta\tau = \Delta t \sqrt{1 - \beta^2}, \quad \beta < 1, \quad (3.19)$$

$$-\Delta\tau = \Delta t \sqrt{\beta^2 - 1}, \quad \beta > 1. \quad (3.20)$$

$$-\Delta\tau = \frac{\Delta x}{c} \sqrt{1 - \beta_1^2}, \quad \beta_1 < 1, \quad (3.21)$$

$$\Delta\tau = \frac{\Delta x}{c} \sqrt{\beta_1^2 - 1}, \quad \beta_1 > 1; \quad (3.22)$$

It is very interesting that the $\Delta x'$, (or Δx) will exchange with Δt (or $\Delta \tau$) in the expressions (3.17)-(3.18) and (3.21)-(3.22).

If we let (see the formula (3.20))

$$f(E, P) = E^4 + c^4 P^4 - 2c^2 E^2 P^2 \quad (3.23)$$

as the catastrophe theory, we could find a catastrophe set

$$E = \pm P \quad (3.24)$$

and we could have four types of the representation for the momentum, the energy, and the mass of a moving particle with the rest mass m :

Type I. TRTT

$$p^T(v) = \frac{mv}{\sqrt{1-\beta^2}}, E^T(v) = \frac{mc^2}{\sqrt{1-\beta^2}}, M^T(v) = \frac{m}{\sqrt{1-\beta^2}}; \quad \beta < 1. \quad (3.25)$$

Type II. SRTT

$$p^S\{v_1\} = \frac{mv_1}{\sqrt{\beta_1^2-1}}, E^S(v_1) = \frac{mc^2}{\sqrt{\beta_1^2-1}}, M^S(v_1) = \frac{m}{\sqrt{\beta_1^2-1}}; \quad \beta_1 > 1. \quad (3.26)$$

Type III. SRST

$$p^S\{v\} = \frac{-mv}{\sqrt{\beta^2-1}}, E^S(v) = \frac{-mc^2}{\sqrt{\beta^2-1}}, M^S(v) = \frac{-m}{\sqrt{\beta^2-1}}; \quad \beta > 1. \quad (3.27)$$

Type IV. TRST

$$p^S\{v_1\} = \frac{-mv_1}{\sqrt{1-\beta_1^2}}, E^S(v_1) = \frac{-mc^2}{\sqrt{1-\beta_1^2}}, M^S(v_1) = \frac{-m}{\sqrt{1-\beta_1^2}}; \quad \beta_1 < 1. \quad (3.28)$$

The transformations between type I (or type II) and type III (or type IV) have the forms

$$p^T(v) = \frac{mv}{\sqrt{1-\beta^2}} = \frac{mc}{\sqrt{\beta_1^2-1}} = \frac{1}{c}E^T(v_1), \quad (3.29)$$

$$E^T(v) = \frac{mc^2}{\sqrt{1-\beta^2}} = \frac{mv_1c}{\sqrt{\beta_1^2-1}} = cp^T(v_1), \quad (3.30)$$

$$M^T(v) = \frac{m}{\sqrt{1-\beta^2}} = \frac{\beta_1 m}{\sqrt{\beta_1^2-1}} = \beta_1 M^T(v_1) \quad (3.31)$$

and

$$p^S(v) = \frac{-mv}{\sqrt{\beta^2-1}} = \frac{-mc}{\sqrt{1-\beta_1^2}} = \frac{1}{c}E^S(v_1), \quad (3.32)$$

$$E^S(v) = \frac{-mc^2}{\sqrt{\beta^2-1}} = \frac{-mv_1c}{\sqrt{1-\beta_1^2}} = cp^S(v_1), \quad (3.33)$$

$$M^S(v) = \frac{-m}{\sqrt{\beta^2-1}} = \frac{-\beta_1 m}{\sqrt{1-\beta_1^2}} = \beta_1 M^S(v_1). \quad (3.34)$$

With these forms above, we could get that when $\beta=\beta_1=1$,

$$cP(c) = E(c) = mc^2 \quad \text{and} \quad M(c) = m. \quad (3.35)$$

Note that although all through Einstein's relativistic physics there occur indications that mass and energy are equivalent according to the formula

$$E = mc^2.$$

But it is only an Einstein's hypothesis.

It is very interesting that from type I and type IV we could get

$$E^2 - c^2p^2 = m^2c^4, \quad v < c \quad \text{and} \quad v_1 < c \quad (\text{i.e., } v > c) \quad (3.36)$$

and from type II and type III

$$E^2 - c^2 p^2 = -m^2 c^4, \quad v > c \quad \text{and} \quad v_1 > c \quad (\text{i.e., } v < c) \quad (3.37)$$

Here, we have forgotten the indices for the types in Equations (3.35) to (3.37). If we let the $H^2(E, P) = E^2 - c^2 P^2$, then we could get

$$f(H, mc) = H^4 - (mc^2)^4. \quad (3.38)$$

It is a type II of the double-cusp catastrophe, we could also get (3.36) and (3.37) from it.

3.4. The Catastrophe a Charged Particle in an Electromagnetic Field on the Finsler Spacetime ds^4

The Hamilton-Jacobi equation for a particle in an electromagnetic field in the Finsler spacetime, formula (2.25) is a type II of the double-cusp catastrophe. We could get that

$$c^2(\nabla S - \frac{e}{c}A)^2 - (\frac{\partial S}{\partial t} + c\Phi)^2 + m^2 c^4 = 0 \quad (3.39)$$

for type I and type IV of the spacetime transformation.

$$c^2(\nabla S - \frac{e}{c}A)^2 - (\frac{\partial S}{\partial t} + c\Phi)^2 - m^2 c^4 = 0 \quad (3.40)$$

for type II and type III of the spacetime transformation.

Now, we consider the catastrophe change of the equation of a charge in an electromagnetic field. By equation (2.26), we could get

$$\frac{d}{dt} \frac{mv}{\sqrt{1 - \beta^2}} = eE_e + \frac{e}{c}v \times H_e, \quad v < c \quad (3.41)$$

and

$$-\frac{d}{dt} \frac{mv}{\sqrt{\beta^2 - 1}} = eE_e + \frac{e}{c}v \times H_e, \quad v > c. \quad (3.42)$$

If we integrate (3.41) and (3.42), then

$$\frac{mc^2}{\sqrt{1-\beta^2}} - \frac{mc^2}{\sqrt{1-\beta_0^2}} = eU, \quad v_0 < c \quad (3.43)$$

and

$$\frac{mc^2}{\sqrt{\beta_0^2-1}} - \frac{mc^2}{\sqrt{\beta^2-1}} = eU, \quad v_0 > c. \quad (3.44)$$

So, the velocity v has

$$v = c\sqrt{1 - \left(\frac{eU}{mc} + 1/\sqrt{1-\beta_0^2}\right)^{-2}} < c, \quad \text{iff } v_0 < c, \quad (3.45)$$

and

$$v = c\sqrt{1 + \left(\frac{eU}{mc} - 1/\sqrt{\beta_0^2-1}\right)^{-2}} > c, \quad \text{iff } v_0 > c. \quad (3.46)$$

The expressions (3.45) and (3.46) mean that if $v_0 < c$, then for the charged particle always $v < c$; and if $v_0 > c$, then $v > c$. The velocity of light will be a bilateral limit: i.e., it is both of the maximum for the subluminal-speeds and the minimum for the superluminal-speeds.

If we let

$$f(H_e, E_e) = H_e^4 + E_e^4 - 2H_e^2 E_e^2, \quad (3.47)$$

we will get that the catastrophe set is

$$H_e = \pm E_e \quad (3.48)$$

and could obtain the spacetime transformation equations for the electromagnetic field components (by (2.31) and (2.32)):

Type I. TRTT

$$\left\{ \begin{array}{ll} H'_x = H_x, & E'_x = E_x, \\ H'_y = \frac{H_y + \beta E_z}{\sqrt{1-\beta^2}}, & E'_y = \frac{E_y - \beta H_z}{\sqrt{1-\beta^2}}, \\ H'_z = \frac{H_z - \beta E_y}{\sqrt{1-\beta^2}}, & E'_z = \frac{E_z + \beta H_y}{\sqrt{1-\beta^2}}. \end{array} \right. \quad (3.49)$$

Type II. SRTT

$$\left\{ \begin{array}{ll} H'_x = H_x, & E'_x = E_x, \\ H'_y = \frac{\beta_1 H_y + E_z}{\sqrt{\beta_1^2 - 1}}, & E'_y = \frac{\beta_1 E_y - H_z}{\sqrt{\beta_1^2 - 1}}, \\ H'_z = \frac{\beta_1 H_z - E_y}{\sqrt{\beta_1^2 - 1}}, & E'_z = \frac{\beta_1 E_z + H_y}{\sqrt{\beta_1^2 - 1}}. \end{array} \right. \quad (3.50)$$

Type III. SRST

$$\left\{ \begin{array}{ll} H'_x = H_x, & E'_x = E_x, \\ -H'_y = \frac{H_y + \beta E_z}{\sqrt{\beta^2 - 1}}, & -E'_y = \frac{E_y - \beta H_z}{\sqrt{\beta^2 - 1}}, \\ -H'_z = \frac{H_z - \beta E_y}{\sqrt{\beta^2 - 1}}, & -E'_z = \frac{E_z + \beta H_y}{\sqrt{\beta^2 - 1}}. \end{array} \right. \quad (3.51)$$

Type IV. TRST

$$\left\{ \begin{array}{ll} H'_x = H_x, & E'_x = E_x, \\ -H'_y = \frac{\beta_1 H_y + E_z}{\sqrt{1 - \beta_1^2}}, & -E'_y = \frac{\beta_1 E_y - H_z}{\sqrt{1 - \beta_1^2}}, \\ -H'_z = \frac{\beta_1 H_z - E_y}{\sqrt{1 - \beta_1^2}}, & -E'_z = \frac{\beta_1 E_z + H_y}{\sqrt{1 - \beta_1^2}}. \end{array} \right. \quad (3.52)$$

3.5. The Interchange of the Forces Between the Attraction and the Rejection

Usually, because of the equivalence of energy and mass in the relativity theory, ones believe that an object has due to its motion will add to its mass. In other words, it will make it harder to increase its speed. This effect is only really significant for objects moving at speeds close to the speed of light. So, only light, or other waves that have no intrinsic mass, can move at the speed of light.

The mass is the measure of the gravitational and inertial properties of matter. Once thought to be conceivably different, gravitational mass and inertial mass have recently been shown to be the same to one part in 10^{11} .

Inertial mass is defined through Newton's second law, $F=ma$, in which m is mass of body. F is the force action upon it, and a is the acceleration of the body induced by the force. If two bodies are acted upon by the same force (as in the idealized case of connection with a massless spring), their instantaneous accelerations will be in inverse ratio to their masses.

Now, we need discuss the problem of defining mass m in terms of the force and acceleration. This, however, implies that force has already been independently defined, which is by no means the case.

3.5.1. Electromagnetic Mass and Electromagnetic Force

It is well known that the mass of the electron is about 2000 times smaller than that of the hydrogen atom. Hence the idea occurs that the electron has, perhaps, no “ordinary” mass at all, but is nothing other than an “atom of electricity”, and that its mass is entirely electromagnetic in origin. Then, the theory found strong support in refined observations of cathode rays and of the β -rays of radioactive substances, which are also ejected electrons. If magnetic action on these rays allows us to determine the ratio of the charge to the mass, $\frac{e}{m_{el}}$, and also their velocity v , and that at first a definite value for $\frac{e}{m_{el}}$ was obtained, which was independent of v if $v \ll c$. But, on proceeding to higher velocities, a decrease of $\frac{e}{m_{el}}$ was found. This effect was particularly clear and could be measured quantitatively in the case of the β -rays of radium, which are only slightly slower than light. The assumption that an electric charge should depend on the velocity is incompatible with the ideas of the electron theory. But, that the mass should depend on the velocity was certainly to be expected if the mass was to be electromagnetic in origin. To arrive at a quantitative theory, it is true, definite assumptions had to be made about the form of the electron and the distribution of the charge on it. M. Abraham (1903) regarded the electron as a rigid sphere, with a charge distributed on the one hand, uniformly over the interior, or, on the other, over the surface, and he showed that both assumptions lead to the same dependence of the electromagnetic mass on the velocity, namely, to an increase of mass with increasing velocity. The faster the electron travels, the more the electromagnetic field resists a further increase of velocity. The increase of m_{el} explains the observed decrease of $\frac{e}{m_{el}}$, and Abraham’s theory agrees quantitatively very well with the results of measurement of Kaufmann (1901) if it is assumed that there is no “ordinary” mass present. But, the electromagnetic force $F = e[E + \frac{1}{c}(v \times H)]$ was believed to be a constant and be independent of the velocity v .

Note that if we support that the mass m is independent of the velocity v , but the electromagnetic force $F = e[E + \frac{1}{c}(v \times H)]$ is dependent of the velocity v , it will be incompatible with neither the ideas of the electron theory nor the results of measurement of Kaufmann. One further matter needs attention: the E and H occurring in the formula for the force F are supposed to refer to that system in which the electron is momentarily at rest.

3.5.2. The Mass and the Force in the Einstein's Special Relativity

In the Einstein's special relativity, Lorentz's formula for the dependency of mass on velocity has a much more general significance than is the electromagnetic mass apparent. It must hold for every kind of mass, no matter whether it is of electro-dynamics origin or not.

Experiments by Kaufmann (1901) and others who have deflected cathode rays by electric and magnetic fields have shown very accurately that the mass of electrons grows with velocity according to Lorentz's formula (??). On the other hand, these measurements can no longer be regarded as a confirmation of the assumption that all mass is of electromagnetic origin. For Einstein's theory of relativity shows that mass as such, regardless of its origin, must depend on velocity in the way described by Lorentz's formula.

Up to now, if we support that all kinds of the mass, m , are independent of the velocity v , but all forces are dependent of the velocity v , it will be incompatible with neither the ideas of the physical theory nor the results of measurement of physics. Could make some new measurements of physics (or some observations of astrophysics) to support this viewed from another standpoint.

3.5.3. The Interchange of the Forces Between the Attraction and the Rejection

Let us return to the Newton's second law, $F=ma$, we can see that the product of mass and acceleration is a quantity antisymmetric with respect to the two interaction particles B and C . We shall now make the hypothesis that the value of this quantity in any given case depends on the relative position of the particles and sometimes on their relative velocities as well as the time. We express this functional dependence by introducing a vector function $F_{BC}(r, \dot{r}, t)$, where r is the position vector of B with respect to C and \dot{r} is the relative velocity. We then write

$$m_B a_{BC} = F_{BC}. \quad (3.53)$$

and define the function F_{BC} as the force acting on the particle B due to the particle C. It is worth while to stress the significance of the definition of force presented here. It will be noted that no merely anthropomorphic notion of push or pull is involved. Eq.(3.53) states that the product of mass and acceleration, usually known as the *kinetic reaction*, is equal to the *force*.

Now, if we explain the experiments by Kaufmann (1901) with here point of view, then, we could say that the electromagnetic force $F = e[E + \frac{1}{c}(v \times H)]$ is a function dependent of the velocity v , $F = F(v)$.

From the above mentioned, the relativity theory provides for an increase of apparent inertial mass with increasing velocity according to the formula

$$m = \frac{m_0}{\sqrt{1 - \beta^2}}$$

could be understood equivalently as a decrease of the effective force of the fields with increasing relativistic velocity between the source of the field and the moving body according to the formula

$$F_{eff} = F\sqrt{1 - \beta^2}.$$

Further, the negative apparent inertial mass could be understood equivalently as the effective forces of the fields have occurred the interchange between the attraction and the rejection according to the formula.

$$F_{eff} = -F\sqrt{\beta^2 - 1}.$$

3.5.4. The *Character Velocity* and *Effective Forces* for a Forces

Up to now, one common essential feature for forces is neglected that the character velocities for forces. Ones commonly believe that if the resistance on the wagon with precisely the same force with which the horse pulls forward on the wagon then the wagon will keep the right line moving with a constant velocity. However, we could ask that if the resistance on the wagon is zero force then will the wagon be continue accelerated by the horse? How high velocity could be got by the wagon? It is very easy understood that the maximum velocity of the wagon, v_{max} , will be the fastest running velocity of the horse, v_{fst} . The velocity v_{fst} is just the character velocity, v_c , for the pulling force of the horse. When the velocity of the wagon is zero velocity, the pulling force of the horse to the wagon has the largest effective value $F_{eff} = F$. We assume that a decrease of the effective force with increasing velocity of the wagon, and $F_{eff} = 0$ if and only if $\beta = \frac{v_w}{v_c} = 1$. If $\beta = \frac{v_w}{v_c} > 1$ then $F_{eff} = -kF$. It means that when the velocity of the wagon v_w is larger the character velocity v_c , not that the horse pulls the wagon, but that the wagon pushes the horse.

If the interactions of the fields traverse empty space with the velocity of light, c , then the velocity of light is just the character velocity for all kinds of the interactions of the fields. We guess that the principle of the constancy of the velocity of light is just a superficial phenomenon of the character of the interactions of the fields.

3.5.5. One Possible Experiment for Distinguish Between Moving Mass and Effective Force

The Newtonian law of universal gravitation assumes that, two bodies attract each other with a force that is proportional to the mass of each body and is inversely proportional to the square of their distance apart:

$$F = G \frac{m_1 m_2}{r^2}. \quad (3.54)$$

According as Einstein's special relativity, if the body₁ is moving with constant speed v with respect to the body₂, then the mass of the body₁ will become with respect to the body₂ that

$$M_1 = \frac{m_1}{\sqrt{1 - \frac{v^2}{c^2}}}. \quad (3.55)$$

According to the principle of equivalence the body's gravitational mass equal to its inertia mass. So, the force of gravitational interaction between the two bodies will be

$$F_{M.M.} = G \frac{m_1 m_2}{r^2 \sqrt{1 - \frac{v^2}{c^2}}}. \quad (3.56)$$

But, according as the theory of the effective force, the force of gravitational interaction between the two bodies will be

$$F_{E.F.} = G \frac{m_1 m_2}{r^2} \sqrt{1 - \frac{v^2}{c^2}}. \quad (3.57)$$

We hope that could design some new experiments to discover this deviation.

3.6. Decay of particles

On the Einstein's special relativity theory, consider the spontaneous decay of a body of mass M into two parts with masses m_1 and m_2 . The law of conservation of energy in the decay, applied in the system of reference in which the body is at rest, gives

$$M = E_{10} + E_{20}, \quad (3.58)$$

where E_{10} and E_{20} are the energies of the emerging particles. Since $E_{10} > m_1$ and $E_{20} > m_2$, the equality (120) can be satisfied only if $M < m_1 + m_2$, i.e. a body can disintegrate spontaneously into parts the sum of whose masses is less than the mass of the body. On the other hand, if $M \geq m_1 + m_2$, the body is stable (with respect to the particular decay) and does not decay spontaneously. To cause the decay in

this case, we would have to supply to the body from outside an amount of energy at least equal to its “binding energy” ($m_1 + m_2 - M$).

Usually, ones believe that momentum as well as energy must be conserved in the decay process. Since the initial momentum of the body was zero, the sum of the momenta of the emerging particles must be zero: $\mathbf{p}_{10} + \mathbf{p}_{20} = 0$ in the special relativity theory. Consequently $p_{10}^2 = p_{20}^2$, or

$$E_{10}^2 - m_1^2 = E_{20}^2 - m_2^2. \quad (3.59)$$

The two equations (3.58) and (3.59) uniquely determine the energies of the emerging particles

$$E_{10} = \frac{M^2 + m_1^2 - m_2^2}{2M}, \quad E_{20} = \frac{M^2 - m_1^2 + m_2^2}{2M}. \quad (3.60)$$

In a certain sense the inverse of this problem is the calculation of the total energy M of two colliding particles in the system of reference in which their total momentum is zero. (This is abbreviated as the “system of the center of inertia” or the “ C -system”.) The computation of this quantity gives a criterion for the possible occurrence of various inelastic collision processes, accompanied by a change in state of the colliding particles, or the “creation” of new particles. A process of this type can occur only if the sum of the masses of the “reaction products” does not exceed M .

Suppose that in the initial reference system (the “laboratory” system) a particle with mass m_1 and energy E_1 collides with a particle of mass m_2 which is at rest. The total energy of the two particles is

$$E = E_1 + E_2 = E_1 + m_2,$$

and their total momentum is $\mathbf{p} = \mathbf{p}_1 + \mathbf{p}_2 = \mathbf{p}_1$. Considering the two particles together as a single composite system, we find the velocity of its motion as a whole from (2.19):

$$V = \frac{p}{E} = \frac{p_1}{E_1 + m_2}. \quad (3.61)$$

This quantity is the velocity of the C -system with respect to the laboratory system (the L -system).

However, in determining the mass M , there is no need to transform from one reference frame to the other. Instead we can make direct use of formula (3.36), which

is applicable to the composite system just as it is to each particle individually. We thus have

$$M^2 = E^2 - p^2 = (E_1 + m_2)^2 - (E_1^2 - m_1^2),$$

from which

$$M^2 = m_1^2 + m_2^2 + 2m_2E_1. \quad (3.62)$$

4. Conclusions

From the discussion in this paper, we could get the following conclusions:

(1) The special theory of relativity cannot negate the possibility of the existence of superluminal-speed.

(2) The essential nature of the superluminal-speed is the relativity of the temporal order. If one does not know how to distinguish the temporal orders, a particle moving with superluminal-speed could be taken for one moving with a subluminal-speed of some unusual nature.

(3) The special theory of relativity could be discussed in the Finsler spacetime. The spacetime transformation on the Finsler metric ds^4 contains a new symmetry between the timelike and spacelike.

(4) Some new invariants describe the catastrophe nature of the Finsler spacetime ds^4 . They obey the double-cusp catastrophe. The timelike state cannot change smoothly into the spacelike state for a motion particle. But a lightlike state could change suddenly into a timelike state and spacelike state. Also, a timelike state and a spacelike state could change suddenly into a lightlike state.

(5) The length x will exchange the position with the time increment t between v 's representation and v 's representation. The momentum (or energy) in the timelike (or spacelike) representation will be transformed into the energy (or momentum) in the spacelike (or timelike) representation.

(6) The difference between the subluminal- and superluminal-speed would be described as follows: a particle with the subluminal-speed has positive momentum, energy, and moving mass, and a particle with the superluminal-speed has negative ones.

(7) Usually, it is believed that Tachyons have a spacelike energy-momentum four-vector so that

$$E^2 < c^2 P^2.$$

Hence, the square of the rest mass m defined by

$$m^2 c^4 = E^2 - c^2 P^2 < 0$$

requires the ‘rest mass’ to be imaginary’ (see Hawking and Ellis, 1973).

As has been said in this paper, from the expressions (3.25)-(3.28) it is clear that, no matter whether a particle is moving with a subluminal- or superluminal-speed, in the timelike representation it will obey Equation (3.36), but, in the spacelike representation it will obey Equation (3.37). So, for a particle with superluminal-speed its mass $M(v)$ (energy $E(v)$, and momentum $P(v)$) is negative rather than imaginary. As expression (3.28)

$$E^S(v_1) = -mc^2$$

when $\beta \rightarrow 0$.

So the particle with superluminal-speed, in the timelike representation, will remain a negative ‘rest-mass’. We shall write:

$$E = \begin{cases} +mc^2 & \text{for subluminal-speed, } i.e., v < c \text{ (or } v_1 > c), \\ -mc^2 & \text{for superluminal-speed, } i.e., v > c \text{ (or } v_1 < c). \end{cases}$$

It was just analyzed by Dirac for the anti-particle. So, we guess that a particle with the superluminal-speed $v > c$ could be regarded as its anti-particle with the dual velocity $v_1 = c^2/v < c$.

References

- [1] Arnold, V.I., *Catastrophe Theory*, Springer-Verlag, Berlin, 1986.
- [2] Asanov, G.S., *Finsler Geometry, Relativity and Gauge Theories*, D.Reidel Publ.Co., Dordrecht, Holland, 1985.
- [3] Shenglin Cao :1988, *Astrophys.Space Sci.*145,299.
- [4] Shenglin Cao:1990, *Astrophys.Space Sci.*174,165.
- [5] Shenglin Cao:1992, *Astrophys.Space Sci.*190,303.
- [6] Shenglin Cao:1992b, *Astrophys.Space Sci.*193,123.
- [7] Shenglin Cao:1993, *Astrophys.Space Sci.*208,191.
- [8] Einstein, A.: 1923, in A.Sommerfeld(ed.), *The Principle of Relativity*, Dover, New York.

- [9] Hawking, S.W. and Ellis,G.F.R.: 1973, *The Large-Scale Structure of Space-Time*, Cambridge University Press. Cambridge.
- [10] Recami, E.: 1986,Nuovo Cimento 9, 1.
- [11] Rindler,W.:1977, *Essential Relativity*, Springer-Verlag,Berlin.
- [12] Rund,H.:1959, *Differential Geometry of Finsler Spaces*, Springer-Verlag,Berlin.
- [13] Sen Gupta N.D.:1973,Indian J. Physics 47,385.
- [14] Zeeman,E.C.:1977, *Catastrophe Theory*, Selected Papers 1972 1977, Addison-Wesley.

A Revision to Gödel's Incompleteness Theorem by Neutrosophy

Yuhua Fu

(China Offshore Oil Research Center, Beijing, 100027, P.R.China)

E-mail: fuyh@cnooc.com.cn

Abstract: According to Smarandache's neutrosophy, the Gödel's incompleteness theorem contains the truth, the falsehood, and the indeterminacy of a statement under consideration. It is shown in this paper that the proof of Gödel's incompleteness theorem is faulty, because all possible situations are not considered (such as the situation where from some axioms wrong results can be deduced, for example, from the axiom of choice the paradox of the doubling ball theorem can be deduced; and many kinds of indeterminate situations, for example, a proposition can be proved in 9999 cases, and only in 1 case it can be neither proved, nor disproved). With all possible situations being considered with Smarandache's neutrosophy, the Gödel's Incompleteness theorem is revised into the incompleteness axiom: Any proposition in any formal mathematical axiom system will represent, respectively, the truth (T), the falsehood (F), and the indeterminacy (I) of the statement under consideration, where T, I, F are standard or non-standard real subsets of $]^{-0}, 1^{+}[$. Considering all possible situations, any possible paradox is no longer a paradox. Finally several famous paradoxes in history, as well as the so-called unified theory, ultimate theory, \dots , etc. are discussed.

Key words: Smarandache's Neutrosophy, Gödel's Incompleteness theorem, Incompleteness axiom, paradox, unified theory.

The most celebrated results of Gödel are as follows.

Gödel's First Incompleteness Theorem: *Any adequate axiomatizable theory is incomplete.*

Gödel's Second Incompleteness Theorem: *In any consistent axiomatizable*

theory which can encode sequences of numbers, the consistency of the system is not provable in the system.

In literature, the Gödel's incompleteness theorem is usually stated by *any formal mathematical axiom system is incomplete, because it always has one proposition that can neither be proved, nor disproved.*

Gödel's incompleteness theorem is a significant result in the history of mathematical logic, and has greatly influenced to mathematics, physics and philosophy among others. But, any theory cannot be the ultimate truth. Accompanying with the science development, new theories will replace the old ones. That is also for the Gödel's incompleteness theorem. This paper will revise the Gödel's Incompleteness theorem into the incompleteness axiom with the Smarandache's neutrosophy.

1. An introduction to Smarandache's neutrosophy

Neutrosophy is proposed by F.Smarandache in 1995. *Neutrosophy* is a new branch of philosophy that studies the origin, nature, and scope of neutralities, as well as their interactions with different ideational spectra.

This theory considers every notion or idea $\langle A \rangle$ together with its opposite or negation $\langle \text{Anti} - A \rangle$ and the spectrum of *neutralities* $\langle \text{Neut} - A \rangle$, i.e., notions or ideas located between the two extremes, supporting neither $\langle A \rangle$ nor $\langle \text{Anti} - A \rangle$. The $\langle \text{Neut} - A \rangle$ and $\langle \text{Anti} - A \rangle$ ideas together are referred to as $\langle \text{Non} - A \rangle$.

Neutrosophy is the base of neutrosophic logic, neutrosophic set, neutrosophic probability and statistics used in engineering applications, especially for software and information fusion, medicine, military, cybernetics and physics, etc..

Neutrosophic Logic is a general framework for unification of existent logics, such as the fuzzy logic, especially intuitionistic fuzzy logic, paraconsistent logic, intuitionistic logic, \dots , etc.. The main idea of Neutrosophic Logic (NL) is to characterize each logical statement in a 3D Neutrosophic Space, where each dimension of the space represents respectively the truth (T), the falsehood (F), and the indeterminacy (I) of the statement under consideration, where T, I, F are standard or non-standard real subsets of $]^{-}0, 1^{+}[$ without necessarily connection between them.

More information on Neutrosophy may be found in references [1-3].

2. Some errors in the proof of Gödel's incompleteness theorem

It has been pointed out some errors in the proofs of Gödel's first and second incom-

pleteness theorems in the reference [4]. This paper will again show that the proof of Gödel's incompleteness theorems contain some errors, but from other point of view. It will be shown that in the proof of Gödel's incompleteness theorem, all possible situations are not considered.

First, in the proof, the following situation is not considered: *wrong results can be deduced from some axioms*. For example, from the axiom of choice a paradox, the doubling ball theorem, can be deduced, which says that a ball of volume 1 can be decomposed into pieces and reassembled into two balls both of volume 1. It follows that in certain cases, the proof of Gödel's incompleteness theorem may be faulty.

Second, in the proof of Gödel's incompleteness theorem, only four situations are considered, that is, one proposition can be proved to be true, cannot be proved to be true, can be proved to be false, cannot be proved to be false and their combinations such as one proposition can neither be proved to be true nor be proved to be false. But those are not all possible situations. In fact, there may be many kinds of indeterminate situations, including it can be proved to be true in some cases and cannot be proved to be true in other cases; it can be proved to be false in some cases and cannot be proved to be false in other cases; it can be proved to be true in some cases and can be proved to be false in other cases; it cannot be proved to be true in some cases and cannot be proved to be false in other cases; it can be proved to be true in some cases and can neither be proved to be true, nor be proved to be false in other cases; and so on.

Because so many situations are not considered, we may say that the proof of Gödel's incompleteness theorem is faulty, at least, is not one with all sided considerations.

In order to better understand each case, we consider an extreme situation where one proposition as shown in Gödel's incompleteness theorem can neither be proved, nor disproved. It may be assumed that this proposition can be proved in 9999 cases, only in 1 case it can neither be proved, nor disproved. We will see whether or not this situation has been considered in the proof of Gödel's incompleteness theorem.

Some people may argue that, this situation is equivalent to that of a proposition can neither be proved, nor disproved. But the difference lies in the distinction between the part and the whole. If one case may represent the whole situation, many important theories cannot be applied. For example the general theory of relativity involves singular points; the law of universal gravitation does not allow the case where the distance r is equal to zero. Accordingly, whether or not one may say that the general theory of relativity and the law of universal gravitation cannot

be applied as a whole? Similarly, the situation also cannot be considered as the one that can be proved. But, this problem may be easily solved with the neutrosophic method.

Moreover, if we apply the Gödel's incompleteness theorem to itself, we may obtain the following possibility: *in one of all formal mathematical axiom systems, the Gödel's incompleteness theorem can neither be proved, nor disproved.*

If all possible situations can be considered, the Gödel's incompleteness theorem can be improved in principle. But, with our boundless universe being ever changing and being extremely complex, it is impossible considering all possible situations. As far as considering all possible situations is concerned, the Smarandache's neutrosophy is a quite useful way, and possibly the best. Therefore this paper proposes to revise the Gödel's incompleteness theorem into the incomplete axiom with Smarandache's neutrosophy.

3. The incompleteness axiom

Considering all possible situations with Smarandache's neutrosophy, one may revise the Gödel's Incompleteness theorem into the incompleteness axiom following.

Any proposition in any formal mathematical axiom system will represent the truth (T), the falsehood (F), and the indeterminacy (I) of the statement under consideration, where T, I, F are standard or non-standard real subsets of $]^{-}0, 1^{+}[$, respectively.

4. Several famous paradoxes in history

The proof of Gödel's incompleteness theorem has a close relation with some paradoxes. However, after considering all possible situations, any paradox may no longer be a paradox.

Now we discuss several famous paradoxes in history.

Example 1. *The Barber paradox, one of Russell's paradoxes.*

Consider all men in a small town as members of a set. Now imagine that a barber puts up a sign in his shop that reads *I shave all those men, and only those men, who do not shave themselves.* Obviously, we may divide the set of men in this town into two subsets, those who shave themselves, and those who are shaved by the barber. To which subset does the barber himself belong? The barber cannot belong to the first subset, because if he shaves himself, he will not be shaved by the barber, or by

himself; he cannot not belong to the second subset as well, because if he is really shaved by the barber, or by himself, he will not be shaved by the barber.

Now we will see from where comes the contradiction.

The contradiction comes from the fact that the barber's rule does not take all possible situations into consideration.

First, we should divide the set of men in this town into three subsets, those who shave themselves, those who are shaved by the barber, and those who neither shave themselves, nor are shaved by the barber. This contradiction can be avoided by the neutrosophy as follows. If the barber belongs to the third subset, no contradiction will appear. For this purpose, the barber should declare himself that he will be the third kind of person, and from now on, he will not be shaved by anyone; otherwise, if the barber's mother is not a barber, he can be shaved by his mother.

Second, the barber cannot shave all men in this town. For example, the barber cannot shave those who refuse to be shaved by the barber. Therefore, if the barber is the one who cannot shave himself and "who refuse to be shaved by the barber" , no contradiction will occur.

There also exist indeterminate situations to avoid the contradiction. The barber may say: *If I meet men from another universe, I will shave myself, otherwise I will not shave myself.*

Example 2. *Liar's paradox, another Russell's paradox.*

Epimenides was a Cretan who said that *all Cretans are liars*. Is this statement true or false? If this statement is true, he (a Cretan) is a liar, therefore, this statement is false; if this statement is false, that means that he is not a liar, this statement will be true. Therefore, we always come across a contradiction.

Now we will see from where comes the contradiction.

First, here the term "liar" should be defined. Considering all possible situations, a "liar" can be one of the following categories: those whose statements are all lies; those whose statements are partly lies, and partly truths; those whose statements are partly lies, partly truths and sometimes it is not possible to judge whether they are truths or lies. For the sake of convenience, at this movement we do not consider the situation where it is not possible to judge whether the statements are true or false.

Next, the first kind of liar is impossible, i.e., a Cretan could not be a liar whose statements are all lies. This conclusion can not be reached by deduction, instead, it is obtained through experience and general knowledge. With the situation where a

liar's statements are partly truths, and partly lies, Epimenides' statement *all Cretans are liars*, will not cause any contradiction. According to the definitions of liar of the second category and the fact that Epimenides' statements could not be all lies, this particular statement of Epimenides' can be true and with his other statements being possibly lies, Epimenides may still be a liar.

This contradiction can be avoided by the neutrosophy as follows.

For this statement of *all Cretans are liars*, besides true or false, we should consider the situation where it is not possible to judge whether the statement is true or false. According to this situation, this *Russell's paradox* can be avoided.

Example 3. *Dialogue paradox.*

Considering the following dialogue between two persons A and B.

A: *what B says is true.*

B: *what A says is false.*

If the statement of A is true, it follows that the statement of B is true, that is, the statement what A says is false is true, which implies that the statement of A must be false. We come to a contradiction.

On the other hand, if the statement of A is false, it follows that the statement of B must be false, that is, the statement what A says is false is false, which implies that the statement of A must be true. We also come to a contradiction.

So the statement of A could neither be true nor false.

Now we will see that how to solve this contradiction.

It should be noted that, this dialogue poses a serious problem. If A speaks first, before B says anything, how can A know whether or not what B says is true? Otherwise, if B speaks first, B would not know whether what A says is true or false. If A and B speak at the same time, they would not know whether the other's statement is true or false.

For solving this problem, we must define the meaning of *lie*. In general situations a *lie* may be defined as follows:

with the knowledge of the facts of cases, a statement does not show with the facts.

But in order to consider all possible situations, especially those in this dialogue, another definition of lie must be given. For the situation when one does not know the facts of the case, and one makes a statement irresponsibly, can this statement

be defined as a lie? There exist two possibilities: *it is a lie, and it is not a lie*. For either possibility, the contradiction can be avoided.

Consider the first possibility, i.e., it is a lie.

If A speaks first, before B makes his statement, it follows that A does not know the facts of the case, and makes the statement irresponsibly, it is a lie. Therefore the statement of A is false. B certainly also knows this point, therefore B's statement: what A says is false is a truth.

Whereas, if B speaks first before A makes his statement, it follows that B does not know the facts of the case, and makes the statement irresponsibly, it is a lie. Therefore the statement of B is false. A certainly also knows this point, therefore A's statement: *what B says is true* is false.

If A and B speak at the same time, it follows that A and B do not know the facts of the case, and make their statements irresponsibly, these statements are all lies. Therefore, the statements of A and B are all false.

Similarly, consider the second possibility, i.e., it is not a lie, the contradiction can be also avoided.

If we do not consider all the above situations, what can we do? With a lie detector! The results of the lie detector can be used to judge whose statement is true, whose statement is false.

4. On the so-called unified theory, ultimate theory and so on

Since Einstein proposed the theory of relativity, the so-called unified theory, ultimate theory and so on have made their appearance.

Not long ago, some scholars pointed out that if the physics really has the unified theory, ultimate theory or theory of everything, the mathematical structure of this theory also is composed by the finite axioms and their deductions. According to the Gödel's incompleteness theorem, there inevitably exists a proposition that cannot be derived by these finite axioms and their deductions. If there is a mathematical proposition that cannot be proved, there must be some physical phenomena that cannot be forecasted. So far all the physical theories are both inconsistent, and incomplete. Thus, the ultimate theory derived by the finite mathematical principles is impossible to be created.

The above discussion is based on the Gödel's incompleteness theorem. With Smarandache's neutrosophy and the incompleteness axiom, the above discussion should be revised.

For example, the proposition *this theory is the ultimate theory* should represent

respective the truth (T), the falsehood (F) and the indeterminacy (I) of the statement under consideration, where T, I, F are standard or non-standard real subsets of $]^{-0, 1^+}$.

Now we discuss the proposition *Newton's law of gravity is the ultimate theory of gravitation* (Proposition A).

According to the Gödel's incompleteness theorem, the ultimate theory is impossible, therefore, the above proposition is 0% true, 0% indeterminate, and 100% false. It may be written as $(0, 0, 1)$.

While according to the incomplete axiom, we may say that the Proposition A is 16.7% true, 33.3% indeterminate, and 50% false. It may be written as $(0.167, 0.333, 0.500)$. The reason for this sentence is on the following.

Consider the containing relation between the ultimate theory of gravitation and Newton's law of gravity. According to the incompleteness axiom, the proposition the ultimate theory of gravitation contains Newton's law of gravity (Proposition B) should represent respective the truth (T), the falsehood (F) and the indeterminacy (I). For the sake of convenience, we may assume that $T = I = F = 33.3\%$.

If the Proposition B is equivalent to the Proposition A, the Proposition A also is 33.3% true, 33.3% indeterminate, and 33.3% false. But they are not equivalent. Therefore we have to see how the ultimate theory of gravitation contains Newton's law of gravity. As is known, to establish the field equation of the general theory of relativity, one has to do a series of mathematical reasoning according to the principle of general covariance and so on, with Newton's law of gravity as the final basis. Suppose that the ultimate theory of gravitation is similar to the general theory of relativity, it depends upon some principle and Newton's law of gravity. Again this principle and Newton's law of gravity are equally important, they all have the same share of truthfulness, namely 16.7% (one half of 33.3%), but the 16.7% shared by this principle may be added to 33.3% for falsehood. Therefore, the Proposition A is 16.7% true, 33.3% indeterminate, and 50% false. It may be written as $(0.167, 0.333, 0.500)$.

This conclusion indicates that Newton's law of universal gravitation will continue to occupy a proper position in the future gravitational theory.

References

- [1] F.Smarandache, *A Unifying Field in Logics: Neutrosophic Logic-Neutrosophy, Neutrosophic Set, Neutrosophic Probability and Statistics*(third edition), Xiquan

- Publishing House, Phoenix, 2003.
- [2] F.Smarandache, V. Christianto, Fu Yuhua, R. Khrapko and J. Hutchison, *Unfolding the Labyrinth: Open Problems in Mathematics, Physics, Astrophysics, and Other Areas of Science*, Hexis, Phoenix, 2006
 - [3] D. Rabounski, F. Smarandache and L.Borissova, *Neutrosophic Methods in General Relativity*, Hexis, 2005
 - [4] Zhou Xunwei, *Mutually-inversistic Mathematical Logic*, Science Publishing Press, Beijing, 2004.

Experimental Determination of Photons in Light Quanta $h\nu$ and Interaction with Electrons

Jingsong Feng

(High-Tech. Research Institute of Chongqing Xinda Group, Chongqing, P.R.China)

E-mail: xindafjs@163.com

Abstract: The present paper studies the interaction between photons and moving electrons outside the atomic nucleus and their precise quantitative relations. In addition, the author of this paper has discovered from experimental determination that the product of the photon number of the wavelength N and the normalized wavelength of electromagnetic wave ($\lambda_N = \lambda_R \bullet \sqrt{1 - \frac{v^2}{C^2}}$) is a constant $\xi = \frac{2h}{m_e C} = 6562.100001nm$. An experimental determination is made of the number of photons in each light quantum ($h\nu$) of electromagnetic waves at different wavelengths, including infrared light, visible light and ultraviolet light. The method and experimental instruments can be found in the reference [4]. The results of the experiment reveal that for the hydrogen spectrum - infrared light wavelength of $1875.11nm$, $1281.81nm$, $1093.8nm$, $1004.98nm$, $954.62nm$, the respective numbers of the photons in each light quantum ($h\nu$) are 3(4), 5, 6, 6(7) and 7. For the hydrogen spectrum - visible light wavelength of $656.21nm$, $486.074nm$, $434.00nm$, the respective numbers of the photons in each light quantum ($h\nu$) are 10, 13 and 15. For the hydrogen spectrum - near ultra violet light wavelength of $386.006nm$, $364.581nm$, the respective numbers of the photons in each light quantum ($h\nu$) are 17 and 18. For the hydrogen spectrum - far ultra violet light wavelength of $121.566nm$, $102.583nm$, $97.254nm$, $94.976nm$ and $93.782nm$, the respective numbers of the photons in each light quantum ($h\nu$) are 54, 64, 67(68), 69, and 70. The photon's mass is found to be $6.73640775 \times 10^{-37}kg$. It is suggested in this paper that a light quantum is different from a photon and it may consist of more than one photons. The theory of single photons proposed by the author of the present paper can satisfactorily reveal the essence of electromagnetic wave and explain many phenomena frequently found in optical experiments. Further researching on

these problems, the Smarandache multi-space theory is a very useful tool.

Keywords: Infrared ray, visible light, ultraviolet radiation, light quantum, photon, photonics annotation, photon and electron, Smarandache multi-spaces.

1. Introduction

1.1 The theory of light as particles and the theory of light as waves

Since the mid-17th century, scientists have conducted systematic studies on light, especially on the nature of light. Many important contributions have been made by scientists such as R.Descartes,1596-1650, I.Newton,1642-1727, F.M.Gri Grimaldi,1618-1663, R.Hook,1635-1703, C.Huygens,1692-1695, J. Bradley1728, W.T.Young,1773-1829, A.J.Fresnel,1788-1827, Malus1808 J.L.Foucault(1850), etc.. But up to now, the disputes between the two theories of light as particles or as waves are still going on without any sign of compromising. At the beginning of the 20th century, the light's illumination phenomena of non-linear crystals were explained based on quantum theory, which have advanced our understanding on the nature of light.

1.2. The Concept of Photons

In order to explain the black body radiation, based on Wien's displacement law, Planck proposed that energy cells of vibrators of different frequencies are different in size, which is proportional to frequency γ , with the proportional constant h being called *acting basic quantum* or *acting quantum*, or *Planck's constant*. Therefore, the energy quantum ε , that is, the difference between adjacent energy levels of vibrators can be expressed as $\varepsilon = h\gamma$.

That is the famous Planck's formula. On December 14, 1900, at a conference on physics in Germany, Planck published this result, as a revolution against the traditional classical concepts. He had abandoned the old ideas that *in nature there are no jumps*, and initiated a new era in physics-the Era of Quantum.

In 1905, A. Einstein published a paper in an authoritative magazine in Germany - *Annalen der Physik (Vol. XVII, 1905)* with illuminating ideas on the generation and transformation of light. In this paper he proposed the concept of photons, and successfully explained a series of problems on the generation and transformation of light, including a discussion on photoemission. Besides, he extended the application range of Planck's concept of quantum and it is implied that light has the nature of both waves and particles [2].

1.3. The limitation of light quantum theory

Since the 1990's, physicists in different countries obtained the same findings that light quantum in non-linear crystals has the nature of synthesizing and decomposing light. Experiments show that in non-linear crystals, a portion of ultraviolet light quantum (with high energy) can be spontaneously disintegrated into two portions of infrared light quantum (with low energy)(down transformation). On the other hand, in non-linear crystals, light from an infrared source, namely, from pump powers, can be transformed into visible light. In other words, this kind of non-linear crystals can absorb several portions of low-energy light quantum (*photon*) and release one portion of high-energy light quantum (photon)(up transformation). Based on this nature of non-linear crystals, rapid progress have been made in experimental techniques, and some light-synthesizing apparatuses have been developed^[3]. However, the theoretical explanations concerning the mechanism of synthesizing and decomposing light remain to be made; traditional light quantum theories are not likely able to satisfactorily explain it. In order to clearly explain the physical mechanism of the light's up-transformation and down-transformation based on the micro-structure of matter, we have to consider the generation mechanism and generation process of synthesizing and decomposing light based on the electrons inside the atom as well as the fundamental nature of light. In this way, we are sure to advance the quantum theory of light into a new stage.

To prepare for these new developments, some innovative ideas are necessary, and at the same time, the reasonable contents of the existing theories must be assimilated. These complicated problems may be solved with Smarandache multi-spaces.

The notion of Smarandache multi-spaces was proposed by Smarandache in 1969^[11,12]. A *Smarandache multi-space* is a union of n different sets or spaces with some different structures (where $n \geq 2$), which can be discrete or continuous spaces, particularly the geometries and space-time in theoretical physics.

Let S_1, S_2, \dots, S_k be distinct two by two structures on the distinct (not necessarily disjoint) two by two sets M_1, M_2, \dots, M_k respectively, where $k \geq 2$ (k may even be infinity). We define a multi-space M to be a union of the previous sets

$$M = M_1 \cup M_2 \cup \dots \cup M_k.$$

Whence, we have k different structures on M . For example we can construct a geometric multi-space formed by a union of three distinct subspaces: *an Euclidean*

space, a hyperbolic space and an elliptic space.

2. The concept of single photon: Experimental determination and study of the number and mass of photons contained in every portion of light quantum

As early as 1991, the author of the present paper suggested that a photon and a light quantum are different, and the latter is made up of many photons of the same shape and nature, and the light quanta of various frequencies come from the various numbers of photons contained in the light quanta. The mass of a single photon is a constant, but the mass of a different light quantum may be different. The mass of a single photon has been precisely determined by experiment as $m_\gamma = 6.73640775 \times 10^{-37} kg$ by the author, that is, the minimum mass of an electron (m_e) is 1352283 ± 1 times as the mass of a photon (m_r). The results from actual determination show that each portion $h\nu$ of the electromagnetic wave released from the electrons in an atom contains a number of photons, which determines its frequency. Besides, the number of photons in every portion of light quantum ($h\nu$), as in the spectrum of red, orange, yellow, green, black, blue, purple, is arranged in arithmetic progression, with the gradation of difference being 1. A red light quantum has 10 photons and a purple light quantum has 16 photons. Notice that the wavelength of a visible light of a certain color may vary in a range, but the number of photons in each portion of light quantum ($h\nu$) corresponding to the color remains the same. The reason is that when electrons in an atom are emitting electromagnetic waves with the same number of photons, the instantaneous velocity of the electrons is different. That is to say, they may have different relative velocities. The detailed discussions may be found in [4]. The mass of the electrons varies with the absorbing and releasing of light quanta of the electrons moving outside the atomic nucleus. The variation of mass shall be included in the dynamic balance equation for molecules' spatial force, otherwise, the precision in determining the molecules' motion parameters will be negatively affected, and what is worse, this can lead to a wrong result^[5].

Complicated problems will be involved in studying photon, light quantum and electron, so we must apply the Smarandache multi-spaces, where problems in different domains may be put together in a same perspective. For example, we may firstly structure the photon space, light quantum space and electron space separately, then, study these three spaces by using the Smarandache multi-spaces in a unified manner. Otherwise, the study can be very complicated.

3. Interaction mechanism of moving photons and electrons outside atomic nucleus

3.1. A formula for determination of the number of the photons contained within a wavelength

$$N = \frac{2h}{\sqrt{1 - \frac{v^2}{C^2}} \cdot \lambda_R \cdot m_\gamma \cdot C}, \quad (1)$$

where,

N – the number of the photons in each portion of light quantum

h – Planck Constant $6.62616 \times 10^{-34} J \cdot S$

C – light speed $2.99792458 \times 10^8 m/s$

m_γ – mass of a single photon $6.73640775 \times 10^{-37} kg$

λ_R – measured wavelength of light quantum, nm

v – the instantaneous velocity of electrons outside atomic nucleus when the electron is releasing the light quantum, m/s , determined with *The Techniques & Apparatus for Determination of the Instantaneous Velocity and the orbit radius of Electrons' Movement Inside Atoms*(patent ZL00105041.9) by Feng Jingsong, as a innovative invention granted by State Intellectual Property Office of P. R.China on March 23rd ,2005. The instantaneous velocity and the orbit radius of electrons moving inside Hydrogen atoms, Helium Ions and Helium atoms have been obtained with that techniques and apparatus in actual determination. This invention was published in *J. Atomic and Molecular Physics*, Vol. 3(Supplement), April 20, 2006, P78-86, compiled by the Subcommittee of Atomic and Molecular Physics of Chinese Society of Physics.

3.2. Formula for determination of the wavelength of light quanta released by Moving electrons outside an atomic nucleus

$$\lambda = \frac{2h}{\sqrt{1 - \frac{v^2}{C^2}} \cdot N \cdot m_\gamma \cdot C}, \quad (2)$$

where the meanings of each symbol is as the same as in the preceding part.

This formula gives the functional relation between the light quanta's wavelength (electromagnetic wave) λ and the number of the photons (N) contained in every portion of light quanta ($h\nu$) and the instantaneous velocity (v) of the moving electrons

outside the atomic nucleus. In other words, the light quantum's wavelength is determined by two factors: the number of the photons (N) contained in every portion of light quanta ($h\nu$) and the instantaneous velocity (v) of the moving electrons outside the atomic nucleus.

3.3. The product of photon number of measured wavelength N and normalized wavelength of electromagnetic wave $\lambda_N = \lambda_R \bullet \sqrt{1 - \frac{v^2}{C^2}}$ obtained from Actual determination is a constant ξ

That is,

$$\xi = N\lambda_N = N\lambda_R \bullet \sqrt{1 - \frac{v^2}{C^2}} = \frac{2h}{m_\gamma C} = 6562.100001nm, \quad (3)$$

where the meanings of each symbol is as the same as in the preceding part.

The physical implication of the constant ξ can be explained as follows: all the light quanta are made up of a succession of N photons. The greatest distance between the photons in a light quantum (that is. the total length of a portion of light quantum) is a constant after normalization. This is determined by the interaction mechanism of moving photons and moving electrons, and it is a universal law in nature.

3.4. A formula for determination of instantaneous velocity of electrons' revolution around the atomic nucleus

$$v = c \bullet \sqrt{1 - \left(\frac{R_R}{R_T}\right)^2}, \quad (4)$$

where,

V - instantaneous velocity of electrons' revolution around the atomic nucleus, m/second;

R_R - the value of Rydberg constant obtained from actual determination, cm^{-1}

R_T - the theoretical value of Rydberg constant $1.09737177 \times 10^5 cm^{-1}$

c - light speed $2.99792458 \times 10^8 m/second$.

3.5. A formula for determination of orbit radius of electrons' revolution around the atomic nucleus

$$r = 28.24382479 \times 10^{-16} z \bullet \sqrt{\frac{1}{\left[1 - \left(\frac{R_R}{1.097373177 \times 10^5}\right)^2\right]^2} - \frac{1}{1 - \left(\frac{R_R}{1.097373177 \times 10^5}\right)^2}} \quad (5)$$

where

- r – the radius of electrons' trajectory around the atomic nucleus; m;
- R_R – the value of Rydberg constant obtained from actual determination; cm^{-1} ;
- z - atomic number, 1, 2, 3, ...

3.6. A formula for Rydberg constant from actual determination

3.6.1 A formula for Rydberg constant (R) in hydrogen spectrum from actual determination

$$R_R = \frac{k^2 n^2}{\lambda_R (n^2 - k^2)}, \quad (6)$$

where,

- R_R - value of Rydberg constant (R) from actual determination, m^{-1}
- λ_R – the wavelength of light quantum from actual determination, nm
- $n = k + 1, k + 2, k + 3, \dots, k = 1, 2, 3, 4, \dots$. Notice that $k = 1$ for Lyman series; $k = 2$ for Balmer series; $k = 3$ for Paschen series; $k = 4$ for Brackett series and $k = 5$ for Pfund series.

With the help of the formula, we can obtain the value of Rydberg constant (R) from actual determination of every spectrum lines of hydrogen atomic spectrum.

3.6.2 A formula for Rydberg constant (R) in helium atomic spectrum from actual determination

According to the actual determination of the wavelength of helium atomic spectrum λ , from the formula

$$\frac{1}{\lambda_R} = R_R \left[\frac{1}{4} - \frac{1}{(n/2)^2} \right], n = 567 \dots,$$

we obtain

$$R_R = \frac{4n^2}{\lambda_R (n^2 - 16)}. \quad (7)$$

With the help of the formula, we can obtain Rydberg constant (R) from actual determination.

3.6.3 A formula for Rydberg constant (R) of emission spectrum of multi-electrons and atoms from actual determination

$$R_R = \frac{k^2 \bullet n^2}{\lambda_R \bullet (n^2 - k^2) \bullet Z^2}. \quad (8)$$

With the help of this formula, we can obtain Rydberg constant (R) of every spectrum line of multi-electron and atomic spectrum from actual determination.

In this expression,

Z - electric charge number of atomic nucleus, that is, the atomic number;

λ_R - wavelength from actual determinationnm

$k = Z, n = k + 1, n = k + 1, k + 2, k + 3, \dots$

4. The precise quantitative relations between moving photons and electrons outside a hydrogen atomic nucleus

4.1. Experimental determination of numbers of photons in a portion of light quantum ($h\nu$) of infrared light, visible light and ultraviolet light

4.1.1. Determination of hydrogen atomic emission spectrum -number of photons in every portion of light quantum in Balmer series (wavelength)

Actual determination of hydrogen atomic emission spectrum-the wavelength of Balmer lines can be found in Table 1, and for further information, please refer to Ni Guangjiong and Li Hongfang *Modern Physics*; Shanghai Science and Technology Publishing HouseAug.1979, P127, 324 for detailed data. With the help of the preceding formulas (4)-(1)and(7), we can obtain Rydberg constant from actual determination corresponding to respective measured wavelength, instantaneous velocity of electrons' motion, radius of electrons' trajectory, the number of photons in every portion of light quantum ($h\nu$) and the corresponding constant ξ .

Table 1 Actual determination of hydrogen atomic emission spectrum - number of photons in every portion of light quantum in Balmer series (wavelength)

natural number	Measured wavelength	Measured Rygberg constant	Instantaneous velocity of electron	Radius of electron's trajectory	Measured number of photons $h\nu$	Theoretical number of photons	$\frac{N_R - N_T}{N_T}$	ξ
n	$\lambda_a (nm)$	$R_a \times 10^7 m^{-1}$	$\nu (km/s)$	$r^{-12} m$	N	N	%	nm
3	656.21	1.097209735	5173.9740	9.464	10	10	0	6561.122
4	486.074	1.097226622	4899.4164	10.554	13.5	13	3.8	6318.118
5	434.010	1.097187798	5510.2393	8.344	15.119	15	0.79	6509.050
6	410.120	1.097239832	4673.4087	11.600	16.0004	16	0.0025	6561.122
7	386.059	1.097163515	5860.4100	7.377	17	17	0	6561.748
8	364.581	1.097259605	4313.0330	13.620	17.999	18	0.005	6561.778

4.1.2 Actual Determination of Hydrogen Atomic Emission Spectrum — Number of Photons in Every Portion of Light Quantum in Paschen Series (wavelength)

Actual determination of hydrogen atomic emission spectrum — Paschen Series' wavelength can be found in Table 2, and the corresponding data are in Lin Meirong, Zhang Baozheng *Atomic Spectroscopy* P20. Science Publishing House, published in October, 1990. With the help of the preceding formulas 4,3,2,1 and 7, we obtain Rydberg constant from actual determination corresponding to respective measured wavelength, instantaneous velocity of electrons' motion, radius of electrons' trajectory, the number of photons in every portion of light quantum $h\nu$ and the corresponding constant ξ .

Table 2 Actual determination of hydrogen atomic emission spectrum - number of photons in every portion of light quantum in Paschen series (wavelength)

natural number	Measured wavelength	Measured Rygberg constant	Instantaneous velocity of electron	Radius of electron's trajectory	Measured number of photons $h\nu$	Theoretical number of photons	$\frac{N_R - N_T}{N_T}$	ξ
n	$\lambda_a (nm)$	$R_a \times 10^7 m^{-1}$	$\nu (km/s)$	$r^{-12} m$	N	N	$\times\%$	nm
4	1875.11	1.097078495	6947.1420	5.2581857	3.5005	3(4)	16.8	7498.425
5	1281.81	1.097081471	6911.9780	5.3118372	5.1207	5	2.4	6407.346
6	1093.80	1.097092704	6777.6058	5.5246056	6.0008	6	0.013	6561.122
7	1004.98	1.097036757	7422.7724	4.6057404	6.5315	6(7)	8.8(7.5)	6028.031
8	954.62	1.097057082	7193.9492	4.9034878	6.8760	7	1.8	7032.703

4.1.3 Actual determination of hydrogen atomic emission spectrum -number of photons in every portion of light quantum in Lyman series (wavelength)

Actual determination of hydrogen atomic emission spectrum - Lyman series' wavelength can be found in Table 3, and the corresponding data are in Lin Meirong, Zhang Baozheng *Atomic Spectroscopy*, P20, Science Press, Beijing, 1990. With the help of the preceding formulas (4) - (1) and (7), we can obtain Rydberg constant from actual determination corresponding to measured wavelength, instantaneous velocity of electrons' motion, radius of electrons' trajectory, the number of photons in every portion of light quantum ($h\nu$) of measured wavelength and the corresponding constant ξ .

Table 3 Actual determination of hydrogen atomic emission spectrum - number of photons in every portion of light quantum in Lyman series (wavelength)

natural number	Measured wavelength	Measured Rygberg constant	Instantaneous velocity of electron	Radius of electron's trajectory	Measured number of photons $h\nu$	Theoretical number of photons	$\frac{N_R - N_T}{N_T}$	ξ
n	$\lambda_a (nm)$	$R_a \times 10^7 m^{-1}$	$\nu (km/s)$	$r^{-12} m$	N	N	$\times\%$	nm
2	121.566	1.096797899	9706.0044	2.6931231	54.0080	54	0.015	6561.122
3	102.583	1.096672938	10708.0992	2.2123963	64.0095	64	0.015	6561.122
4	97.254	1.096784365	9819.4823	2.6312047	67.5100	67(68)	0.76	6512.521
5	94.976	1.096768306	9952.4512	2.5613288	69.2303	69	0.19	6549.731
6	93.782	1.096768493	9950.9131	2.5621212	70.0104	70	0.15	6561.122

4.2 The Dynamic Law on the Precise Quantitative Relations between the Number of Moving Photons and Moving Electrons outside Hydrogen Nucleus

A detailed study on the mechanism concerning the moving electrons' (inside hydrogen atoms) emitting Balmer Lines spectrum shows that the frequency of moving electrons' emitting light quantum can be determined by the inertia force that prevents the moving electrons to deviate from their orbit.

By adopting the data from actual determination of hydrogen atomic emission spectrum-the Balmer lines, we find that the atomic nucleus, electrons and photons within the structure of hydrogen molecules follow a dynamic law of interaction as shown below, see Fig.1. The detailed findings are published in the reference [7].

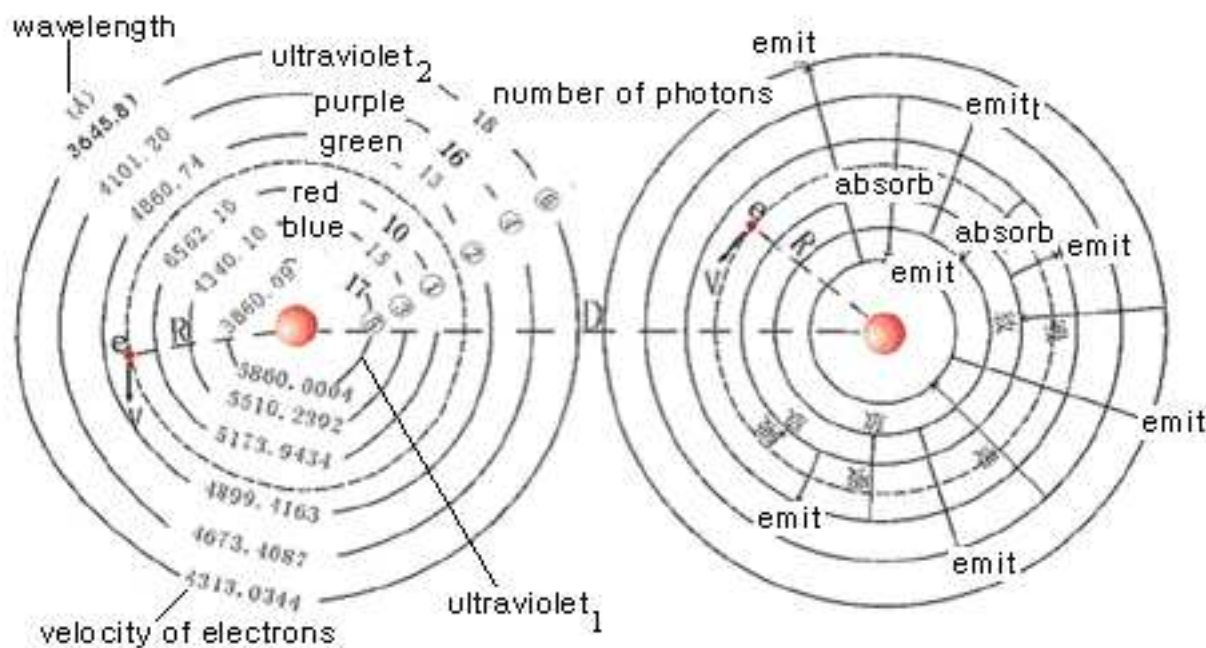

Fig.1 Sketch map of hydrogen molecules (H_2)

4.2.1 In electrons' movement around the atomic nucleus, one may find a long cycle, which may be divided into three shorter cycles. During every short cycle, electro-

magnetic waves are being absorbed and released; during every long cycles, there are three different courses of absorbing and releasing electromagnetic waves. During any long period, hydrogen atoms just repeat the above process of absorbing and releasing electromagnetic waves. During every cycle, electrons will release electromagnetic waves six times, which correspond red, green, blue, purple, ultraviolet 1, and ultraviolet 2 radiations. The numbers of released photons every time are, respectively, 10, 13, 15, 16, 17, and 18. During the first short cycle, electrons release red and green electromagnetic waves, with numbers of photons being 10 and 13, respectively, a total of 23 photons. During the second short cycle, electrons release blue and purple electromagnetic waves, with numbers of photons being 15 and 16, respectively, a total of 31 photons. During the third short cycle, electrons release ultraviolet 1, and ultraviolet 2 electromagnetic waves, with numbers of photons being 17 and 18, respectively, a total of 35 photons. During the second short cycle, 8 more photons are released than during the first one, while during the third short cycle 4 more photons are released than during the second one.

4.2.2 When an electron releases red, green, blue, purple, ultraviolet₁ and ultraviolet₂ electromagnetic waves, it is located in different positions and at different velocities. During every short cycle, an electron emits electromagnetic waves twice. Its velocity changes when it emits electromagnetic waves in different positions. That is to say, the electron moves sometimes fast and sometimes slow. Sometimes the electron is in a position near the atomic nucleus, and sometimes, it is in a position far away from the atomic nucleus. The radius R of electrons' trajectory around the atomic nucleus changes periodically, and so does its velocity.

4.2.3 According to the data from actual determination, when electrons emit electromagnetic waves, their velocity of revolution decreases; while their velocity of revolution increases when electrons absorb electromagnetic waves. So, it can be concluded that when electrons decelerate, they emit electromagnetic waves; and when electrons absorb electromagnetic waves, they accelerate.

4.2.4 Hydrogen molecule is made up of two hydrogen atoms. Taking into consideration all above observations concerning hydrogen atoms and the physical law that an object will expand when hot and will shrink when cold, it can be concluded that when objects absorb electromagnetic waves, the distance between the atomic nuclei will increase, the objects expand, the radius of the electrons' trajectory around the atomic nucleus diminishes, and electrons accelerate; when objects release electromagnetic waves, the distance between the atomic nuclei reduces, and electrons

decelerate.

4.2.5 The relationship between the sequence number of spectrums' locations and the sequence number of electrons' locations

For a long time, people hold the idea that the sequence number of the spectrums determines the energy level of the electrons inside the atom structure. However, recent experiments and theories have shown that this is not the case. The electrons' energy level can only be determined from their velocity obtained by measuring its spectrum. So, the sequence number of the spectrums' location is essentially different from the sequence number of the electrons' location. The sequence number of the electrons' location indicates the orbit position of the electrons when the electrons are emitting/releasing electromagnetic waves of a certain frequency. The serial number indicates the sequence number of the electrons in each shell, which determines the distance from the atomic nucleus when electrons emitting/ releasing electromagnetic waves. The smaller the serial number is, the nearer it is to the atomic nucleus. The sequence number of spectrums shows the sequence of the spectrums created by the electromagnetic waves (photons) emitted from a certain substance. The smaller the serial number is, the greater the wavelength is and the smaller the frequency is. The sequence number of the electromagnetic waves' spectrums emitted by the electrons in every shell is not always sequential. This is because there is only one "series" of spectrum sequence number for a same substance while corresponding to it there may be several electromagnetic waves emitted by electrons in different shells. Therefore, the sequence number of the spectrums' location is not the sequence number of the electrons' location. The frequency of the electromagnetic waves emitted by electrons is not determined by the distance between the electrons and the atomic nucleus, but by the inertia force that prevents the electrons to deviate from the orbit. The greater the inertia force is, the farther away the electrons will be from the balance position and the greater the frequency of electromagnetic waves emitted by electrons will be. that is. the greater the number of the photons contained in every portion of light quantum will be. It can be seen from ultraviolet ¹(17),ultraviolet ²(18) radiations in Fig.1. On the other hand, the smaller the inertia force is, the nearer the electrons will be from the balance position and the frequency of electromagnetic waves emitted by electrons will be greater. that is, the number of the photons contained in every portion of light quantum will be smaller. It can be seen from the red (10) and green (13) radiations in Fig.1. Such experimental results are in accordance with Newton's mechanics.

5. Conclusion

5.1 The present paper reveals the precise quantitative relations between moving photons and the moving electrons outside the atomic nucleus. In addition, the author of this paper has discovered the fact that the product of the photon number of the wavelength N obtained from experimental determination and the normalized wavelength of electromagnetic wave also obtained from the experimental determination ($\lambda_N = \lambda_R \bullet \sqrt{1 - \frac{v^2}{C^2}}$) is a constant $\xi = \frac{2h}{m_\gamma C} = 65621.100001nm$. The physical implication of the constant ξ may be explained as follows: all the light quanta are made up of a succession of N photons in motion in the space. The greatest distance between the photons in a light quantum (that is, the total length of a portion of light quantum) is a constant after normalization. This is determined by the interaction mechanism of moving photons and moving electrons outside an atomic nucleus, and this is a universal law of nature. Errors are unavoidable in experimental determination, and the theoretical value of Rydberg constant was obtained on the assumption that the mass of a moving electron outside atomic nucleus is a constant, so it is reasonable to assume that some data in the tables are only approximate.

5.2 Analysis of the results obtained from actual determination concerning the number of the photons contained in every portion of light quantum $h\nu$ of infrared, visible and ultraviolet radiations shows that the margin of error between the theoretical value and the measured value of infrared, visible and ultraviolet radiations ranges mostly from 0.9% to 0.08% with only a few exceptions related with infrared radiations, which reach as high as 16.8%. This may be due to the limited precision of the apparatus. Furthermore, the measured data in the above tables were obtained in the 1980's with apparatuses of limited precision.

5.3 With the errors of actual determination being removed, we find for the hydrogen spectrum - infrared light wavelength of 1875.11nm, 1281.81nm, 1093.8nm, 1004.98nm, 954.62nm, the respective numbers of the photons in each light quantum ($h\nu$) are 3 (4), 5, 6, 6 (7) and 7. For the hydrogen spectrum - visible light wavelength of 656.21nm, 486.074nm, 434.00nm, the respective numbers of the photons in each light quantum ($h\nu$) are 10, 13 and 15. For the hydrogen spectrum -near ultra violet light wavelength of 386.006nm, 364.581nm, the respective numbers of the photons in each light quantum ($h\nu$) are 17 and 18. For the hydrogen spectrum - far ultra violet light wavelength of 121.566nm, 102.583nm, 97.254nm, 94.976nm and 93.782nm, the respective numbers of the photons in each light quantum ($h\nu$) are 54, 64, 67 (68), 69 and 70. More data may be found in tables in the present paper.

5.4 The photon's mass is $6.73640775 \times 10^{-37} kg$. It is shown that a light quantum is different from a photon and each light quantum consists of several photons.

Based on the experimental determination and theoretical analysis, we show that in each light quantum ($h\nu$) of different frequencies, the numbers of the photons in infrared radiations are, respectively, 1, 2, 3, 4, 5, 6, 7, 8 and 9; the numbers of the photons in visible light are, respectively, 10, 11, 12, 13, 14, 15 and 16; the numbers of the photons in ultraviolet radiations are, respectively, 17, 18, 19... , 54 ... , 64, 65, 66, 67, 68, 69, 70, Each light quantum of X-ray and Gamma ray contains more photons and the exact numbers of such rays remain unknown and will be determined in future experimental determination.

5.5 From infrared radiations to Gamma ray, the frequency of different electromagnetic waves is the number of times or frequencies of the emission of photons by the moving electrons outside the atomic nucleus when a photon moves across the distance of $2.99792458 \times 10^8 m$ at the speed of light in a second. In other words, it is the number of photons emitted in a certain unit of time. Different frequency is due to the difference in the number of photons emitted in a certain unit of time. The different wavelength of electromagnetic wave is the distance covered by the photons moving at the speed of light during the interval of the two emissions of photons outside the atomic nucleus, namely, the distance between two sequential moving photons. While the electromagnetic waves of different wavelengths consist essentially of sequential different light quanta emitted by the moving electrons outside the atomic nucleus with different numbers of photons at different velocity and at different interval of the two emissions. Therefore, the essence of electromagnetic wave is the light quanta with photons combined in a sequence arranged by different natural numbers. The essence of microwave and radio wave is also the light quanta emitted by electrons outside the nucleus composed of micro-photons or single photons. The difference is that the interval of the two emissions of micro-photons (or single photons) by the microwave and radio wave is longer than that the infrared radiations. To make it clearer, after the first emission of photons, there will be an interval of (Δt) before the second emission. What is more, for microwave and radio wave of different wavelengths, the length of the interval (Δt) is different. The longer the wavelength is, the longer the interval of the two emissions (Δt) will be. This also helps to explain the differences between radio wave and other electromagnetic waves.

5.6 The author of the present paper has conducted actual determinations and numerical analysis for the same parameters concerning helium ions, helium atoms,

neon atoms and sodium atoms. The findings prove that the precise quantitative relations concerning the moving photons and moving electrons outside the hydrogen atomic nucleus are reliable. Owing to the limited space in the present paper, further discussions will be in another paper.

In addition, the theory of single photons proposed by the author of the present paper can satisfactorily explain the essence of electromagnetic wave, and explain a lot of phenomena frequently found in experiments concerning optics.

6. References

- [1] Xie Enzhe, *Concise Handbook on History of Natural Sciences*, Shandong Educational Press, 1987, p319.
- [2] Zhengkun, *Research into the Unknown*, People's Educational Press, 1987, p43.
- [3] *Physics in the New Century*, Shandong Educational Press, 2005, P59-60.
- [4] Feng Jingsong, Experimental determination of micro-photons' mass, *Acta Sinica Quantum Optica*(Supplement), Vol.10(2004), p45.
- [5] Huang Youzhi, Invention and Innovation, *Supplement*, Invention and Innovation Press. April, 2006, 138-169.
- [6] Wang Zhuxi and Zhu Hongyuan, *Encyclopedia Sinica*, Physics Volumes 2, Encyclopedia Sinica Publishing House, 1987, P697.
- [7] *Physical Journal of Atoms and Molecules*, Vol.3, Supplement, 2006, P78-86, Compiled by the Subcommittee of Atom and Molecule Physics of Chinese Physical Society.
- [8] Lin Meirong, Zhang Baozheng *Atomic Spectroscopy*, Science Press, 1990.
- [9] Ni Guangjiong and Li Hongfang, *Modern Physics*, Shanghai Science and Technology Publishing House, 1979, p127 and p324.
- [10] Zhang Lijuan(translated), *Table of Gas and Steam Laser Spectrum*, Science Press, 1981.
- [11] F.Smarandache, Mixed noneuclidean geometries, *eprint arXiv: math/0010119*, 10/2000.
- [12] F.Smarandache, *A Unifying Field in Logics- Neutrosophy: Neutrosophic Probability, Set, and Logic*, American research Press, Rehoboth, 1999.

Applications of Smarandache's notion to Physics and Conservation of Energy

Yuhua Fu

(China Offshore Oil Research Center, Beijing, 100027, China)

E-mail: fuyh@cnooc.com.cn

Abstract: One of the reasons for restricted applications so far of Smarandache geometries and neutrosophic methods in the fields of traditional physics and astrophysics is that these fields involve too many mutually compatible truths. To solve that problem, the science of conservation of energy regards the law of conservation of energy as the only truth and relates everything to energy. This paper also introduces the quantization method (fractal quantization and parameter quantization) and associate a movement trajectory with a governing law, therefore, to define a movement trajectory governed by a given law as well as the geometric axioms with physical interpretations. In this way, we have found a new way to construct Smarandache geometries and to extend the applications of Smarandache geometries, neutrosophic and quantization methods. Finally, the concept of having only one truth is further discussed to extend the these applications to a more wide range.

Key words: Smarandache Geometry, Neutrosophy, Law of conservation of energy, Science of conservation of energy, fractal quantization, parameter quantization.

Smarandache geometries and neutrosophic methods have already contributed more successful applications[1-4]. However, they have not been widely applied to some traditional fields, such as those of traditional physics. This paper proposes a concept of having only one truth in a certain field and to extend the applications of Smarandache geometries, neutrosophic methods and quantization methods (fractal quantization and parameter quantization) to a more wide range.

1. Introduction to Smarandache geometries and neutrosophic methods

Smarandache geometries was first proposed by F.Smarandache in 1969. An axiom

is said *smarandachely denied* if in the same space the axiom behaves differently, i.e., validated and invalidated; or only invalidated but in at least two distinct ways.

A *Smarandache geometry* is a geometry which has at least one smarandachely denied axiom.

Thus, as a particular case, Euclidean, Lobachevsky-Bolyai-Gauss, and Riemannian geometries may be united altogether, in the same space, by some Smarandache geometries. These last geometries can be partially Euclidean and partially non-Euclidean.

L.F.Mao has been shown that Smarandache geometries are connected with the theory of relativity because they include the Riemannian geometry in a subspace and with the parallel universes (see his two papers in this collection).

More information about Smarandachely denied axioms and Smarandache geometries may be found in references [1,3].

Neutrosophy was first proposed by Florentin Smarandache in 1995. *Neutrosophy* is a new branch of philosophy that studies the origin, nature, and scope of neutralities, as well as their interactions with different ideational spectra. This theory considers every notion or idea $\langle A \rangle$ together with its opposite or negation $\langle \text{Anti} - A \rangle$ and the spectrum of neutralities $\langle \text{Neut} - A \rangle$ i.e. notions or ideas located between the two extremes, supporting neither $\langle A \rangle$ nor $\langle \text{Anti} - A \rangle$. The $\langle \text{Neut} - A \rangle$ and $\langle \text{Anti} - A \rangle$ ideas together are referred to as $\langle \text{Non} - A \rangle$.

Neutrosophy is the base of neutrosophic logic, neutrosophic set, neutrosophic probability and statistics used in engineering applications especially for software and information fusion, medicine, military, cybernetics and physics, etc..

Neutrosophic Logic(NL) is a general framework for unification of many existing logics, such as fuzzy logic, especially intuitionistic fuzzy logic, paraconsistent logic, intuitionistic logic, etc.. The main idea of NL is to characterize each logical statement in a 3D Neutrosophic Space, where each dimension of the space represents respectively the truth (T), the falsehood (F), and the indeterminacy (I) of the statement under consideration, where T, I, F are standard or non-standard real subsets of $]0, 1[$ with not necessarily any connection between them.

More information about Neutrosophy may be found in references [2-4].

2. Brief introduction to science of energy conservation

The *science of conservation of energy* was first proposed in the reference [5]. Its some researches can also be found in the reference [3].

In science of conservation of energy, the law of conservation of energy plays a

leading role. For all problems related with energy, the law of conservation of energy is the only truth; other laws will be derived from or verified by the law of conservation of energy. In this paper four issues are discussed. First, the relationship between force, mass and velocity is reconsidered according to the law of conservation of energy. It is shown that in the general expression of the force $F = f(m, v, x, y, z, t)$, the form of the function can be obtained by applying the law of conservation of energy. Second, it is shown that other laws, such as the law of gravity and law of Coulomb, can be derived by applying the law of conservation of energy. Thirdly, it is shown that other laws should be verified or denied according to the law of conservation of energy, and as examples, it is shown that the law of conservation of momentum and the law of conservation of angular momentum are not correct since their results are in contradiction with the law of conservation of energy. Fourthly, an old discipline of sciences can be updated into a new one; for example, Newton's mechanics can be updated into New Newton's mechanics, in which the law of conservation of energy is taken as the source law to obtain the law of gravity and Newton's second law. New Newton's mechanics can be used partly in place of relativity and even can be used to solve problems which can not be solved by relativity.

The cases where the law of conservation of momentum and the law of conservation of angular momentum are not valid since the results obtained by applying them are in contradiction with the law of conservation of energy can be summarized as follows.

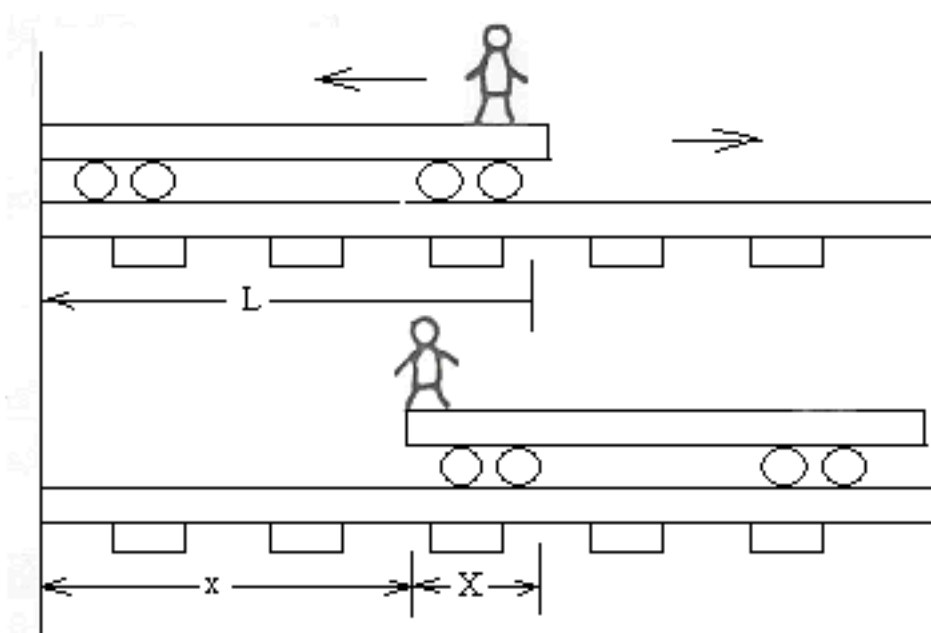

Fig.1 One person walks along a vehicle on a level and lubricated rail

Example 1. A vehicle of length L is put on a level smooth railway rail as shown in Fig.1, and, a person (or robot) stands on one end of the vehicle. At the beginning, the person and the vehicle are all in rest. When the person walks from one end of the vehicle to another, what will be the movement of the person and the vehicle?

It should be noted that the same problem can also be posed in astrophysics. Then the vehicle may be replaced by a spaceship, two persons, wearing iron shoes, will walk in symmetrical positions, for example, one person on magnetic floor, another on magnetic ceiling), in order to keep the trajectory of the spaceship in a straight line.

The problem is usually solved with the law of conservation of momentum. But with the law of conservation of energy, different results will be obtained.

Suppose that m_1 is the person's mass, m_2 is the vehicle's mass, and other variables will be similarly indexed (with similar subscripts). The energy responsible for the movements of the person and the vehicle comes from the person's power, which can be expressed as: $W = K_1t + K_2t^2 + K_3t^3$, where $K_i, i = 1, 2, 3$ are arbitrary constants. Suppose also that the person and the vehicle move with velocities relative to the ground expressed as $v_1 = a_1t + a_2t^2$; $v_2 = b_1t + b_2t^2$. According to the law of conservation of energy, at any time we have: $\frac{1}{2}m_1^2v_1^2 + \frac{1}{2}m_2^2v_2^2 - \int_0^t W = 0$. Substituting the related quantities into this equation, comparing coefficients of t^2, t^3 and t^4 , we get three equations following.

$$\begin{aligned}\frac{1}{2}m_1a_1^2 + \frac{1}{2}m_2b_1^2 &= \frac{K_1}{2}, \\ m_1a_1a_2 + m_2b_1b_2 &= \frac{K_2}{3}, \\ \frac{1}{2}m_1a_2^2 + \frac{1}{2}m_2b_2^2 &= \frac{K_3}{4}.\end{aligned}$$

To determine the velocities, i.e., the coefficients a_1, a_2, b_1, b_2 , another equation should be supplemented. If we use the law of conservation of momentum, comparing the coefficients of t and t^2 , we have the following two equations $m_1a_1 = -m_2b_1$, $m_1a_2 = -m_2b_2$. From the above mentioned five equations, we may determine the four coefficients a_1, a_2, b_1, b_2 . Incompatible results will be obtained. For simplicity, let $m_2 = 2m_1$. It may be shown that, to satisfy the five equations at the same time, we obtain $K_2 = \frac{5}{4}\sqrt{2K_1K_3}$. But according to the above-mentioned hypothesis, K_i are arbitrary constants, therefore, we conclude that, in this example, the law of conservation of energy is in contradiction with the law of conservation of momentum. Similarly, it may be proved that, in this example the law of conservation of angular momentum is in contradiction with the law of conservation of energy.

To find the solution in conformity with the law of conservation of energy, one should consider the actual speed as a function of time. For example, we assume that $K_1 = 10Nm/s^2$, $K_2 = 1Nm/s^3$, $K_3 = 0.1Nm/s^4$ where $m_1 = 100kg$ is the person's mass and $m_2 = 2m_1$ the vehicle's mass. At $t_0 = 1s$, the person's speed relative to the ground is $v_{10} = 0.28m/s$. From these conditions, we know that $a_1 = 0.279854$, $a_2 = 0.000145989$, $b_1 = -0.1041195$, $b_2 = -0.01581105$. With this solution, the law of conservation of energy is contradicts to the law of conservation of momentum.

It should be noted that if the person's power is not $W = K_1t + K_2t^2 + K_3t^3$, but is $W = K_0t$, different results will be obtained. In fact, if $v_1 = at$, $v_2 = bt$, the results simultaneously satisfying the law of conservation of energy and the law of conservation of momentum are: $a = \sqrt{\frac{m_2K_0}{m_1^2+m_1m_2}}$, $b = -\frac{m_1a}{m_2}$. From these results, the total angular momentum is equal to zero before the movement. If the person's center of gravity and the vehicle's center of gravity are located at the same level, these results are also in conformity with the law of conservation of angular momentum. But the person's center of gravity and the vehicle's are usually located not at the same level, thus the total angular momentum is not equal to zero during the movement, therefore for these results the law of conservation of angular momentum is not satisfied.

3. Applications of Smarandache's notions to physics and conservation of energy

Now we associate a movement trajectory with a given law, and through defining a movement trajectory satisfying a given law as well as the geometric axioms with proper physical interpretations, construct Smarandache geometries, find more extensive applications of the Smarandache geometries and neutrosophic methods.

It should be noted that in Smarandache geometries, while defining the smarandachely denied cases, only situations of validated and invalidated are considered. But, between these two situations, there may be a third situation, the indeterminate, as is considered in neutrosophy, where one could not determine whether or not a proposition is validated, sometimes it is validated and sometimes it is invalidated, sometimes one could determine, sometimes one could not determine and so on. In author's opinion, this third situation should also be considered in Smarandache Geometry, which is a topic worth further studying.

In the reference [9], one finds an economics model to Smarandache anti-geometry by making the following correlations: (i) *a point is the balance in a particular checking account, expressed in U.S. currency.* (ii) *A line is a person, who can be a human*

being. (iii) *A plane is a U.S. bank affiliated to the FDIC.*

Similarly, one may find a physical model to Smarandache geometry by making the following correlations: (i) *A point is the mass point, and the like.* (ii) *A line is a movement trajectory, and the like.* (iii) *A plane is a gravitational field, and the like.*

When we associate a movement trajectory with a governing law, the situation of indeterminacy must be considered.

If a movement trajectory satisfies the law of conservation of energy, we may call it a trajectory satisfying the law of conservation of energy.

If a movement trajectory does not satisfy the law of conservation of energy, we may call it a trajectory denied by the law of conservation of energy.

If for a movement trajectory, one could not determine whether or not the law of conservation of energy is satisfied, or sometimes it is satisfied and sometimes it is not, or sometimes one could determine and sometimes one could not, or other indeterminate situations, we may call the trajectory indeterminately satisfying the law of conservation of energy.

Similarly we may define the trajectory satisfying the law of conservation of momentum, the trajectory denied by the law of conservation of momentum, the trajectory indeterminately satisfying the law of conservation of momentum, the trajectory satisfying the law of conservation of angular momentum, the trajectory denied by the law of conservation of angular momentum, the trajectory indeterminately satisfying the law of conservation of angular momentum, and other trajectories.

Considering that the axiom system of an Euclidean Geometry contains five axioms, if we associate a movement trajectory with a governing law, we must at least supplement the following three axioms.

Sixth axiom: *All movement trajectories satisfy the law of conservation of energy.*

Seventh axiom: *All movement trajectories satisfy the law of conservation of momentum.*

Eighth axiom: *All movement trajectories satisfy the law of conservation of angular momentum.*

In traditional physics, the law of conservation of energy, the law of conservation of momentum and the law of conservation of angular momentum all are taken as the truth, and they are mutually compatible, therefore, above three axioms pose no question.

But, with the advent of the science of conservation of energy, the law of con-

servation of energy is taken as the only truth, therefore, in certain situations the above mentioned seventh axiom and eighth axiom must be replaced by other axioms. Thus, a Smarandache geometry can be constructed with this new method.

Example 2. A vehicle of length L is put on a level smooth railway rail as shown in Fig.1, and, a person stands on the one end of the vehicle. The person walks from one end to another, consuming his power $W = K_1t + K_2t^2 + K_3t^3$, where $K_i, i = 1, 2, 3$ are arbitrary constants. Define s -lines as the person's trajectories (level lines). Then we obtain a Smarandache geometry. Because two axioms are smarandachely denied with respect to the above mentioned axiom system including eight axioms.

The seventh axiom in the original system reads that all movement trajectories satisfy the law of conservation of momentum, which is now replaced by all movement trajectories satisfy the law of conservation of momentum or are denied by the law of conservation of momentum. It is because for different values of K_i , the law of conservation of momentum may be satisfied, or not satisfied.

The eighth axiom in the original system reads that all movement trajectories satisfy the law of conservation of angular momentum, which is now replaced by all movement trajectories satisfy the law of conservation of angular momentum or are denied by the law of conservation of angular momentum. It is also because for different values of K_i , and different positions of person's center of gravity, the law of conservation of angular momentum may be satisfied, or not satisfied.

With Smarandache geometries thus constructed, the Smarandache geometries and neutrosophy as they are now, may be conveniently applied to physics and the science of conservation of energy. In reference [4], some problems related to the theory of relativity were discussed.

For problems related to the theory of relativity, the above mentioned three added axioms with respect to the existing five axioms of the axiom system of Euclidean Geometry, must be replaced by the following axioms.

Sixth axiom: *All movement trajectories satisfy the general theory of relativity.*

Seventh axiom: *All movement trajectories satisfy the special theory of relativity.*

Some sub-axioms may be added with respect to the sixth axiom or seventh axiom. For example, in the special theory of relativity, nothing in universe moves faster than light. Therefore, we have the following axiom.

Axiom A: *In all movement trajectories, the speed is less than or equal to the speed of light c .*

But Smarandache has pointed out in the reference [6] that, there is no speed barrier in the universe, which may be expressed as the following axiom.

Axiom A': *In all movement trajectories, the speed is less than or greater than or equal to the speed of light c .*

Now we consider the Neutrosophic methods applied to physics and science of conservation of energy.

Example 3. When a person walks from one end to another end of the vehicle, as shown in Figure 1, we will study the law of conservation of momentum, to see whether it is true, indeterminate and false in that case with the neutrosophic method.

According to the neutrosophic method, the proposition The law of conservation of momentum is correct does not mean a fixed-valued component structure. The truth value depends/changes with respect to different conditions.

In traditional physics, the law of conservation of momentum is a truth. Therefore the proposition the law of conservation of momentum is correct is 100% true, 0% indeterminate, and 0% false. It may be written as $(1, 0, 0)$.

But in science of conservation of energy, the law of conservation of momentum may be correct or may not. Therefore the different results will be reached for different situations.

Assume that $K_1 = 2$, $K_2 = 5$, $K_3 = 4$ or $K_3 \neq 4$, $K_3 = 5$ or $K_3 = 6$. That is, we will consider cases following.

First case: $K_1 = 2$, $K_2 = 5$, $K_3 = 4$.

Second case: $K_1 = 2$, $K_2 = 5$, $K_3 = 5$.

Third case: $K_1 = 2$, $K_2 = 5$, $K_3 = 6$.

Fourth case: $K_1 = 2$, $K_2 = 5$, sometimes $K_3 = 4$, sometimes $K_3 = 5$, and sometimes $K_3 = 6$.

For the first case, we see that the following relation is satisfied $K_2 = \frac{5}{4}\sqrt{2K_1K_3}$. Therefore, the law of conservation of momentum is correct.

For the second case and the third case, the above relation is not satisfied, therefore, the law of conservation of momentum is not correct.

For the fourth case, the above relation is sometimes satisfied and sometimes not. In other words, we cannot determine whether or not the law of conservation of momentum is correct.

Therefore, if we consider the above four cases as a whole, the proposition The

law of conservation of momentum is correct is 25% true, 25% indeterminate, and 50% false. It may be written as $(0.25, 0.25, 0.5)$.

4. Application of Smarandache's notions and quantization methods to astrophysics

Now we consider two examples.

Example 4. Assume that a spaceship navigates along a straight line with a continuously varying speed originally. We may consider five consecutive segments on the straight line, and use the average speed on each line segment to represent the speed of the entire line segment, then the speed of the spacecraft is no longer continuous, we call that speed quantization. Similarly, we may define quantization of other parameters such as energy and temperature. Let the average speeds in the five line segments be, respectively, $0.6c, 0.8c, 0.9c$, indeterminate (measuring instrument does not work and so on), $1.2c$, where c is the speed of light. Define s -lines as above mentioned line segments after quantization, then we obtain a Smarandache Geometry. Because according to Axiom A, in all movement trajectories, the speed is less than or equal to speed of light c . Two cases are invalidated. In one case, the speed is greater than the speed of light; and in another case, the speed is indeterminate.

According to the neutrosophic method, and considering the above mentioned five line segments after quantization, the proposition in all movement trajectories the speed is less than or equal to the speed of light c is 60% true, 20% indeterminate, and 20% false. It may be written as $(0.6, 0.2, 0.2)$.

By the same way, as far as the original ellipse orbit and other track of a planet are concerned, the law of conservation of energy and the law of conservation of momentum are all tenable. But, if we divide the ellipse orbit and other track into certain sections, and carry out speed quantization because for each section the speed is constant, an analysis is needed to see whether or not the results simultaneously satisfy the law of conservation of energy and the law of conservation of momentum. We will discuss this problem in another paper.

Example 5. According to the quantization in astrophysics by fractal method for the data of nine planets in solar system, construct Smarandache geometry, and analyze the result with neutrosophic method.

The quantization in astrophysics by fractal method can be done by taking integers for certain variables in the formula of fractal distribution.

Now, in the fractal distribution $N = \frac{C}{r^D}$, we carry out the quantization for N ,

namely, use N as an index to the planets: $N = 1, 2, 3, \dots$.

Consider the orbital motion of the nine planets, take the average velocity (with unit of km/s) of a planet as the characteristic dimension r and the value of N for the serial number according to the orbital motion average velocity. First consider the case of Mercury $r = 47.89$, we have $N = 1$ (Mercury's orbital motion average velocity is the greatest), therefore, we have a coordinate point $(47.89, 1)$. Similarly, we have other 8 planet coordinate points as follows:

$$(35.03, 2), (29.79, 3), (24.13, 4), (13.06, 5), (9.64, 6), (6.81, 7), (5.43, 8), (4.74, 9).$$

The 9 coordinate points may be plotted on the double logarithmic coordinates, then we may obtain 8 straight line segments. In order to study Smarandache geometries and neutrosophic methods, here we do not fit these 8 straight line segments into a curve with the least squares method, but use the coordinate points of the 8 straight lines to determine accurately their fractal parameters (constant C and fractal dimension D). For example, according to Mercury's coordinates $(47.89, 1)$ and Venus's coordinates $(35.03, 2)$, one may obtain the fractal parameters for the first straight line segment $C = 5302.684$, $D = 2.216639$. The fractal distribution for the first straight line segment can be expressed as

$$N = \frac{5302.684}{r^{2.216639}}.$$

This formula may be used as the extrapolation formula to predict the orbital motion average velocity of the next planet (Earth) by substituting $N = 3$ into this formula and solving for r . Similarly, all predicted results for other planets may be obtained.

By using the 1st straight-line segment, the predicted average velocity of the next planet (Earth) is $V = 29.17$ with an error of 2.07%.

By using the 2nd straight-line segment, the predicted average velocity of the next planet (Mars) is $V = 26.55$ with an error of 10.0%.

By using the 3rd straight-line segment, the predicted average velocity of the next planet (Jupiter) is $V = 20.49$ with an error of 59.9%.

By using the 4th straight-line segment, the predicted average velocity of the next planet (Saturn) is $V = 7.91$ with an error of 18.0%.

By using the 5th straight-line segment, the predicted average velocity of the next planet (Uranus) is $V = 7.46$, with an error of 9.51%.

By using the 6th straight-line segment, the predicted average velocity of the next planet (Neptune) is $V = 5.04$ with an error of 7.19%.

By using the 7th straight-line segment, the predicted average velocity of the next planet (Pluto) is $V = 4.45$ with an error of 6.18%.

By using the 8th straight-line segment, the predicted average velocity of the next planet (tenth planet) is $V = 4.20$ and the error is unknown, because the tenth planet has not yet been discovered.

Defining s -lines as the fractal straight lines linking two coordinate points of the neighboring two planets and the error of the prediction for the next planet is less than or equal to 10%, we obtain a Smarandache Geometry. Because from Axiom A1: there is a straight line between any two points. Two cases are invalidated. In one case, the error is greater than 10%, therefore, it is not an s -line; in another case, the error is indeterminate.

According to the neutrosophic method, and considering the above mentioned 8 line segments, the proposition there is a straight line between any two points is 62.5% true, 12.5% indeterminate, and 25% false. It may be written as (0.625, 0.125, 0.25).

5. Applications to more wide range

5.1. Application of Smarandache's notion to more wide range

Because the concept of Smarandachely denied is contained in Smarandache geometries and the concept of falsehood is contained in neutrosophic method, if one intends to apply Smarandache geometries and/or neutrosophic method to a certain field, one has to find the situations of the denied and/or falsehood in that field

For this purpose, we may adopt the procedure used in science of conservation of energy, that is, only one law or principle is selected as the principal truth in a certain field. Other laws or principles will be derived by it, or verified by it, or denied as wrong by it.

In Chinese ancient philosophy, this procedure may be realized. According to the *Taiji theory*, one of the highest achievements of Chinese ancient philosophy, where *Taiji* means *Primal chaos, Ultimate, Source and so on*. The source of universe is the *Taiji* and any field also has a *Taiji* as the source.

All movements are started by the *Taiji*. It was said in the *Book of Changes* that

changes originate in the Taiji (Primal chaos, Ultimate, Source), come with two spheres, and from the two spheres come with four elements, and from the four elements come with the eight diagrams (eight combinations of three whole or broken

lines formerly used in divination) and so on.

Lao Tzu, a famous philosopher in ancient China once said in one of his book *Tao Te Ching* that *tao generates one, one generates two, two generates three, and three generates everything.*

5.2. Application of quantization method to a more wide range

An improvement of above mentioned fractal quantization and parameter quantization may extend their applications in a more wide range.

For example, if parameters after quantization are expressed as V_1, V_2, V_3, \dots , we may obtain their accumulated sums as $S_1 = V_1, S_2 = V_1 + V_2, S_3 = V_1 + V_2 + V_3, \dots$; and may further obtain the accumulated sums of the previous accumulated sums, and so on. After that, a random series with positive terms, which sometimes is increasing, and sometimes is decreasing, will finally become a monotonously increasing series.

When using fractal distribution, one may have variable dimension fractals (D is not a constant) in place of constant dimension fractals (D is a constant).

By using the above methods, the typhoon paths were forecasted [7]. The stock price and index of oil were forecasted [8].

Similarly, one may also use above methods to forecast the paths of a particle in the Brownian movement. We will discuss that problem in another paper.

References

- [1] Kuciuk, L. and Antholy M., An introduction to Smarandache geometries, *Mathematics Magazine*, Aurora, Canada, Vol.12, 2003
- [2] F.Smarandache, *A Unifying Field in Logics: Neutrosophic Logic- Neutrosophy, Neutrosophic Set, Neutrosophic Probability and Statistics*(third edition), Xiquan Publishing House, Phoenix, 2003.
- [3] F.Smarandache, V. Christianto, Fu Yuhua, R. Khrapko and J. Hutchison, *Unfolding the Labyrinth: Open Problems in Mathematics, Physics, Astrophysics, and Other Areas of Science*, Hexis, Phoenix, 2006
- [4] D. Rabounski, F. Smarandache, L.Borissova, *Neutrosophic Methods in General Relativity*, Hexis, Phoenix, 2005.
- [5] Yuhua Fu, Science of conservation of energy(in Chinese), *Journal of Dezhou University*, 2004(6):20-24.
- [6] F.Smarandache, There is no speed barrier in the universe, *Bulletin of Pure and*

- Applied Science*, Delhi, India, Vol.17D(Physics), No.1.p.61(1998).
- [7] Yuhua Fu, Forecasting typhoon tracks with fractal distribution model(in Chinese), *China Offshore Oil & Gas (Engineering)*, 1999(1):36-39
- [8] Yuhua Fu and Fu Anjie. To predict the stock price and index of oil by using fractal method (in Chinese), *China Offshore Platform*, 2002(6):41-45.
- [9] Torretti, R. An economics model for the Smarandache anti-geometry *International Journal of Social Economics*, 2002, Vol. 29; Part 11/12, 876-886.

The Basis of Relativity Theory & A Smarandache Geometrical Model of Macro-Physics

Changwei Hu

(Room 54, No.2 Tianshanwucun, Shanghai 200336, P.R. China)

E-mail: huchangwei5@yahoo.com.cn

Abstract: The derivation of Lorentz transformation by fluid mechanics shows that there is an intrinsic relationship between the absolute and relativistic space-time theories, and the ether is just the physical vacuum, which is a super-fluid in vacuum state, where lies the physical basis of the theory of relativity. On this basis, the Smarandache geometry model of macro-physics is constructed: the subspace without ether or without the space-time effect of ether can be considered as the absolute space; the subspace with homogeneously distributed ether is the Minkowski space; the subspace with inhomogeneously distributed ether is the Riemann space. Among the three subspaces, the absolute space is the elementary subspace, the other two are created by the space-time effect of ether: the higher is the ether density, the shorter the ruler and the slower the clock, and the curvature of Riemann space indicates the variation rate of standards of time and length. In this way, one may also see the limitations of the theory of relativity.

Key words: Smarandache geometries, elementary subspace, ether (physical vacuum), duplicate time-space theory, physical basis of relativity theory.

1. The elementary subspaces in the model of Smarandache geometry

A Smarandache geometry^[1] is a geometry that has at least one Smarandachely denied axiom in this geometry. It follows that it is the geometry with at least two subspaces. Is there an elementary subspace among these subspaces that other subspaces may be derived from it? The answer is negative from the point of view

of pure mathematics, but there may be a positive answer generally in a concrete Smarandache geometry model.

The Euclidean space is the simplest and most intuitive space, so it may be regarded as the elementary subspace generally when the model of a Smarandache geometry is constructed. The following is such an example.

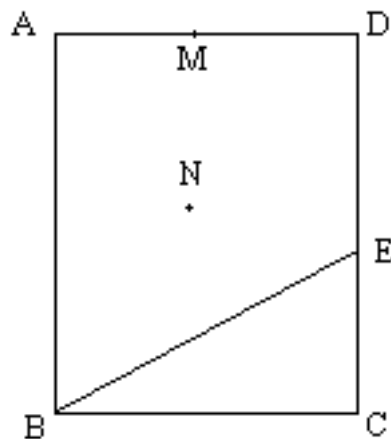

Fig.1

In the above picture, the rectangle ABCD and the points within it are regarded as a geometry space, where, the points are taken as the points in the conventional sense, but the line is taken as the line segment linking points on opposite sides; and the parallel lines are line segments without points of intersection. This is a Smarandache geometry model, because, it includes three geometric subspaces: for a line BE and a point N within the rectangle, there are infinite number lines, which pass the point N and are parallel to the BE. So we have a hyperboloid; for a point M on the AD, we have only a line AD that passes the point M and is parallel to the BE, so we have a Euclidean plane; moreover, there has not a line passing the point C and parallel to the BE, so we have an ellipsoid.

In the Smarandache geometry of the rectangle ABCD, there are three subspaces. Obviously, the Euclidean space is the most elementary space, the other two spaces are derivatives, can be obtained through the condition of boundary and modifications of the definition of line and parallel line on the basis of Euclidean space.

There are three spaces in macro-physics, i.e., the absolute space in Newtonian physics, the Minkowski space in the special theory of relativity and the Riemann space in the general theory of relativity. The Minkowski space is a four dimensional Euclidean space, and different from the absolute space. The former considers the space and time as closely interconnected and varying with the velocity. But the

latter considers the space and time as not interconnected and not varying with the velocity. If the proposition that *the space and time are not interconnected and can not vary with the velocity* is taken as an axiom in the absolute space, it would be possible to construct a Smarandache geometry model of macro-physics. Then wether is there an elementary subspace among the absolute space, Minkowski space and Riemann space in this model? The question should be analyzed in physics.

2. The derivation of Lorentz transformation by fluid mechanics

Physics is different from mathematics in the fact that its logic has two aspects, namely the *physical basis of things with respect to their qualitative nature and characteristics* and *the formal logic with respect to their quantitative* (including geometric) relations, by which one may define how they relate with each other and transform from each other. The theory of relativity has defined a series of quantitative relations, but it does not offer an explanation with respect to the physical basis for these quantitative relations, for example, it does not explain *why the light speed is invariable*. Then how can we reveal the physical basis of the theory of relativity? The derivation of Lorentz transformation by fluid mechanics is instructive.

The Lorentz transformation is the core of relativistic space-time theory. Einstein derived it from the principle of invariance of the light speed. We will derive it by a method of fluid mechanics, through which one may see the theory of relativity from a different angle.

In fluid mechanics, the velocity potential ϕ of incompressible fluid satisfies the equation

$$\Delta\phi(x.y.z) = 0. \quad (1)$$

In other hand, if the velocity is not affected when the fluid penetrates into itself, the velocity potential ϕ of compressible fluid satisfies the equation

$$\left(1 - \frac{v^2}{c^2}\right) \frac{\partial^2\phi}{\partial x^2} + \frac{\partial^2\phi}{\partial y^2} + \frac{\partial^2\phi}{\partial z^2} = 0, \quad (2)$$

where c^v are the sound and flow speeds in the fluid, respectively. We substitute the following into (2):

$$\begin{cases} x' = \beta x, \\ y' = y, \\ z' = z. \end{cases} \quad \left(\beta = \frac{1}{\sqrt{1 - \frac{v^2}{c^2}}} \right) \quad (3)$$

Then the equation is identified with (1): $\Delta\phi(x', y', z') = 0$. So (3) is the transformation of fluid from compressible to incompressible state.

For two special super-fluids, satisfying equation (2), let them make a relative movement with speed v , in the absolute time-space theory, we will have Galileo transformation between them

$$\begin{cases} x_2 = x_1 - vt_1 \\ y_2 = y_1 \\ z_2 = z_1 \end{cases} \quad (4)$$

and

$$\begin{cases} x_1 = x_2 + vt_2 \\ y_1 = y_2 \\ z_1 = z_2 \end{cases} \quad (5)$$

(Note: here time t is written as t_1 and t_2 separately)

Substitute (3) into (4) and (5), where x_1 in (4) and x_2 in (5) do not change due to the fact that they are in relative rest, we obtain

$$\begin{cases} x'_2 = \beta(x'_1 - vt_1) \\ y'_2 = y'_1 \\ z'_2 = z'_1 \end{cases} \quad (6)$$

and

$$\begin{cases} x'_1 = \beta(x'_2 + vt_2) \\ y'_1 = y'_2 \\ z'_1 = z'_2 \end{cases} \quad (7)$$

Substitute the first equation in (6) into that in (7), we obtain

$$t_2 = \frac{1}{v\beta} \left(x'_1 - \beta^2 x'_1 + \beta^2 vt_1 \right) = \beta \left(t_1 - \frac{x'_1(\beta^2 - 1)}{v\beta^2} \right).$$

Substitute $\beta^2 = \frac{c^2}{c^2 - v^2}$ into it, we obtain

$$t_2 = \beta \left(t_1 - \frac{vx'_1}{c^2} \right) \quad (8)$$

If the sound speed of the special super-fluid is replaced by the light speed, then the combination of (6) and (8) is just the Lorentz transformation

Above derivation is not strict, but it is most important to understand the following relation among the physical vacuum, object and gravitational field.

Lorentz transformation may be obtained by various methods of derivation. Both the Lorentz's hypothesis and Einstein's derivation did not show their physical nature, while the above derivation demonstrates that if a special fluid can be transformed from compressible to incompressible state, then Lorentz transformation may be derived from Galileo transformation. Here one may see the physical background, not only the material nature of the physical vacuum, but also the dual nature of the time-space theory.

3. The physical vacuum is a special medium

The derivation of Lorentz transformation by fluid mechanics shows the existence of a special super-fluid, where velocity will not be affected when the fluid penetrates into itself, and its sound speed corresponds to the light speed. What is this special super-fluid? It can not be a conventional fluid, and it can only be the physical vacuum.

The vacuum is not void. Microscopically, the physical vacuum is the basic state of quantum field. Macroscopically, the physical vacuum is the four dimensional space-time continuum in the relativistic time-space; at the same time, the derivation of Lorentz transformation by fluid mechanics shows that the physical vacuum can be seen as a compressible super-fluid in the absolute time-space theory. Due to materialistic nature of the physical vacuum instead of being a void space, and also due to its being the medium of light propagation, so it would be better that the physical vacuum is called *ether*.

The ether theory is generally believed to be refuted by the theory of relativity, which is not case actually. Einstein's idea about ether^[3] was quite self-contradictory. In Einstein's mind, the ether exists, but he did not understand its nature. In 1920, he had made a speech about ether and the theory of relativity, he said: According to the general theory of relativity, space without ether is unthinkable. For in such space there not only would be no propagation of light, but also no possibility of existence for standards of space and time (measuring-rods and clocks), nor therefore any space-time intervals in the physical sense. But this ether may not be thought of as endowed with the quality characteristic of ponderable inertia, as consisting of parts which may be tracked through time. The idea of motion may not be applied to it.

Here, according to Einstein, ether is the medium for light propagation, the standards of space and time depend on the existence of ether (which is very important, but he did not quite understand it), different from the conventional matter (medium with inertia) and can not be described by the space-time theory of relativity. These statements are quite right. But he described the ether (physical vacuum) as a four dimensional space-time continuum, while it is impossible for the space-time theory of relativity to describe the four dimensional space-time continuum, just like one can not raise oneself by pulling his own hair. So Einstein can only be very evasive about ether. Afterwards, he proposed to take the field as the representative of reality. But so-called field by him is the curvature field of space-time thus the matter had been geometrized.

The development of quantum theory shows clearly that there are the effects of vacuum fluctuation, vacuum polarization etc. in the physical vacuum, with complicated physical characteristics. Therefore, the physical vacuum is considered as the basic state of quantum field. However, the concept of quantum field means quite a lot of different things. Without a unified meaning, it may be related to the photon, lepton, quark, gluon, meson, baryon etc., which can all be the quantum of field.

Actually, a field is a state with a continuously distributed physical quantity. For example, the field of atmospheric density is a state with a continuously distributed atmospheric density in space; the field of temperature is a state with a continuously distributed temperature in medium. So the field is not a basic form of matter. The material basis of the atmospheric density field is the atmosphere, the material basis of the temperature field is the medium with a temperature distribution, etc. Then what is the material basis of the gravitational field and the electric field? It is the physical vacuum, a medium in vacuum state, as the only basic existing form of matter different from real objects. The physical vacuum has no mass, while the real object is matter with mass. The quantum characteristics of a field is only a manifestation of interaction or interconnection between the physical vacuum and objects. In fact, the theory of quantum field shows^[4] that vacuum tunneling effect, vacuum phase transformation, vacuum condensation, vacuum domain structure are involved in the physical vacuum, which resembles a medium, as being called ether in this paper.

Ether is a super-fluid. There are two different sounds in a general super-fluid: the sound of density wave, which is the conventional sound; and the sound of temperature wave, which propagates with heat. In the vacuum, the thermal propagation is carried out through thermal radiation, namely, similar to the electromagnetic wave,

so the electromagnetic wave, including the light, is the second sound in ether.

The connotation of the ether concept varies in its historical development: the ether in Descartes's mind is different from that in Aristotle's mind; the ether of the 19th century is different from Descartes ether; in our ether, the mechanical characteristics of the ether in the 19th century will be discarded and the concepts of modern physics including the theory of relativity will be incorporated.

4. Duplicate time-space theory and the correspondence relation

The derivation of Lorentz transformation by fluid dynamics further shows the physical meaning of Lorentz transformation, as the result of a transformation of the ether fluid from a compressible state in absolute time-space into an incompressible state in four dimensional space-time in the theory of relativity. So we have a duplicate time-space theory: the absolute time-space theory and relativistic space-time theory. In the former theory, one space-time standard is used to measure whole world in a unified manner; while in the latter theory, the standard of space-time can change with moving velocity or gravitational field. The two theories are independent of each other, and have a relationship with the state of ether. They are different in nature, thus one can not be replaced by the other. Besides, the absolute space-time theory and corresponding compressibility of ether are the primary nature; the relativistic space-time theory and corresponding incompressibility of ether (the homogeneity of ether and invariance of light speed) are realized through transformation (3), so they are the secondary nature. These show that a description based on the absolute space-time theory reflects the truth of the materialistic world and may be called the qualitative description; a description based on the relativistic space-time theory not necessarily reflects the truth of the materialistic world, but can show the behavior and interactions of actual rulers and clocks, and may be called the quantitative description. There is a great disparity between these two descriptions and there is also certain relationship between them.

In a macroscopic system, ether should satisfy the equation of continuity $\frac{\partial \rho}{\partial t} + \text{div} \rho \vec{u} = 0$. Applying Lorentz covariance, we obtain

$$\left\{ \begin{array}{l} \rho' = \beta \rho \left(1 - \frac{vu_x}{c^2}\right) \\ \rho' u'_x = \beta (\rho u_x - v\rho) \\ \rho' u'_y = \rho u_y \\ \rho' u'_z = \rho u_z \end{array} \right. \quad (9)$$

In (9), if the density ρ is replaced by mass m , we will obtain the same relations as the transformation of mass and momentum in the theory of relativity. Therefore, we can say that the density of ether is related with mass. Because mass is not related with spatial dimensions and considering the relations between mass and gravitational field, we may see the intrinsic relation among the ether, gravitational field and real objects with mass: the distribution of ether density is closely related with real objects with mass in the unified ether ocean of the cosmos, the real object with mass is the core of ether density wave-packet, its mass center is the position where the ether density takes the maximum value; the gravitational potential corresponds to ether density; the intensity of gravitational field corresponds to the gradient of ether density; the mass corresponds to the variation of ether density (closely related with the maximum value of ether density). In acoustics, we have the equation $P = \rho c^2$ (where ρ is the variation of density; P is the variation of the pressure; c is the sound speed). According to the relation between mass m and energy $E = mc^2$, the energy corresponds to the variation of ether pressure (closely related with the maximum value of ether pressure). When the object is moving, an ether wave will propagate in its surrounding gravitational field. Therefore, when two objects are making a relative motion, and if no collision occurs between them, the penetrations accompanying their ether wave-packet would have no influence on their velocity, so equation (2) will be hold.

The mass corresponds with the variation of ether density of the object. Therefore, the object is matter with mass, while ether is matter without mass. The distribution of ether around the object will change when the object is moving, so ether is not an absolute frame of reference.

Owing to the difference of time-space theories, qualitative and quantitative descriptions will give different results for a same thing. To consider qualitatively, the gravitational field is the field of ether density, the ether is a compressible super-fluid and the deflection of light in the gravitational field will bend toward the direction where the ether density is higher, which is identical with the way of the conventional sound propagation. To consider quantitatively, the gravitational field is the field of time-space curvature, the ether is a homogeneous continuum in four dimensional space-time and the light propagates along the geodesic in the curved space-time.

There is a disparity between the qualitative and quantitative descriptions, which explains a puzzle of the old ether theory: based on the direct mechanical model of ether proposed by Fresnel et al (qualitative description) , a quantitatively satisfactory relation can not obtained; while the ether model proposed by Lorentz can

lead to a quantitatively satisfactory relation, but fails to give a direct mechanical picture. Various theories of vacuum, proposed by scholars, will encounter similar circumstances. Here we should use the theory of duplicated time-space, where the qualitative and quantitative descriptions can be complementary.

5. The physical basis of the theory of relativity and its limitations

The relativistic phenomena include kinematical effects of the special theory of relativity and gravitational effects of the general theory of relativity. Now we can combine these two kinds of effects into an effect of ether density. In the positions where the ether density is high, the ruler will become shorter and the clock goes slower. The kinematical effects are due to ether's compressibility. When the object moves in a compressible ether, the density of ether's wave-packet is raised, so the ruler becomes shorter and the clock goes slower. The gravitational effect is due to the correspondence between the ether density and the gravitational potential. In the place where the gravitational potential has a larger value, the ruler becomes shorter and the clock goes slower. Microscopically, the ether is the basic state of quantum field, which is the assembly of the virtual bosons (as are called by us *ether particles*, and where virtual means the lowest energy state with no independent wave-packet of ether density formed), which are composed of pairs of positive and negative particles, as the most elementary and universal Bose-Einstein condensation. Then we can say, the relativistic phenomena are the demonstration of the space-time effect created by ether, with its essential feature being the dependence of the actual standards of length and time on ether, i.e., the unit length is proportional to the interval of the ether particles and the unit time is proportional to the time interval by which the light propagates through the interval of ether particles. Using such standards to measure ether, ether becomes a homogeneous and isotropic four dimensional space-time continuum, where the light speed is constant, of course. Einstein regards this result of invariance of light speed as a hypothesis, thus the true nature of the theory of relativity was obscured. Besides, both of the standards of length and time are related to the interval of ether particles, thus the space and time are interconnected.

Because the kinematical effects are due to ether's compressibility, we must take the ether field where the object is located as the reference frame. On the earth surface, the gravitational field of the earth assumes an absolute dominance. So we must take the gravitational ether field of the earth as the reference frame. The experiment of an atomic clock flying around the earth carried out by Hafele and Keating in 1971^[5] has proved this point. The experiment shows that on the average,

the flying clock is slower by 59×10^{-9} second than the clock on the ground after flying towards the east; and the flying clock is faster by 273×10^{-9} second than the clock on the ground after flying towards the west. It demonstrates that the proposition “a moving clock is slower than a clock in rest” of the theory of relativity does not hold true. Here we must take the earth’s mass center as the origin of the coordinates system, only in this way can we make calculations with the formulae of the theory of relativity, and obtain results roughly in agreement with experiment. Actually this coordinates system with the earth’s mass center as the origin is the same as the coordinates system with the gravitational ether field of the earth as the reference frame.

The ether distribution is closely related with the object distribution. To take the ether field where the moving object is located as the reference frame is the same as to take a coordinates system with the common mass center of a material system in a certain range as the origin. The motion relative to this reference frame is the substantial motion, otherwise, it is regarded as the formal motion. For example, the motion of an airplane relative to the mass center of earth is a substantial motion, while the relative motion between two airplanes is a formal motion; the motion of the earth relative to the mass center of the sun is a substantial motion, while the relative motion between the earth and other planets is a formal motion. The formulae of the special theory of relativity are valid for substantial motions, but not for formal motions (the errors are too small to be discovered as compared with the light speed). For instance, the movement of high energy particles in accelerator relative to the earth is a substantial motion, so these particles will really increase their mass during the movement. According to the principle of relativity, the earth is also in a relative motion with respect to these particles, but it is only a formal motion, therefore, the earth does not increase its mass. The movement of a star relative to the earth due to the rotation of the earth is a formal motion, so the formulae of the special theory of relativity are not valid, otherwise, the velocity of the star will be much greater than the light speed, when the star is more than one light-year far away from the earth.

In the absolute space-time theory, the time and space, which are not related to matter, are invariable. But the actual standards of length and time, which are always related to the object, may vary with the ether density. The special theory of relativity regards the variation of the standards of length and time as the variation of space-time itself and describes them with the Minkowski space, which is equivalent to regarding ether as a homogeneous four dimensional space-time continuum. So

the space-time of the theory of relativity is taken as “matter”, which is not the real space-time. The general theory of relativity regards further the variation rates of standards of time and length as the curvatures of space-time, and describe them with the Riemann space. Therefore, the Minkowski space and the Riemann space are all mathematical models of quantitative description and not real spaces. They are just like the isotopic spin space, which is only a mathematical model. The objective space-time is just a three dimensional space and one dimensional time in the absolute space-time.

6. A Smarandache geometrical model of macro-physics

With the time being taken as the fourth dimension of a space, a Smarandache geometry model of macro-physics can be established with the same physical basis as that of the theory of relativity.

The space of macro-physics is a kind of Smarandache geometry spaces since the subspace without ether or where the space-time effect of ether can be omitted is the absolute space, the subspace with homogeneously distributed ether, where the space-time effect of ether should be considered is a Minkowski space and the subspace with inhomogeneously distributed ether, where the space-time effect of ether should be considered is a Riemann space. Here the absolute space is the elementary and real space, the other two spaces are created by the space-time effect of ether, and are derived from the absolute space.

In our macroscopic system, the space without ether does not exist, but generally, the gravitational field is weak, the velocity of object is much smaller than the light speed, so the space-time effects of ether can be neglected, then the space can be regarded as the absolute space.

To describe high-speed objects such as high energy particles, the kinematical effect of ether can not be neglected, thus the space is turned into a Minkowski space. But the movement is not always a relative movement, one should take the ether where the moving object is located as the frame of reference, in order to describe it with the formulae of the special theory of relativity. On the other hand, the formulae of the special theory of relativity are only approximate, because when the speed of object is comparable with the light speed, whether the ether can be taken as a super-fluid remains a question, and equation (2) may not necessarily be valid. Actually, Einstein has said: “for a field of very large intensity or matter of very large density, the field equations and related variables in the field will not have actual significance, because these equations can not be extended into such regions.”

So the formulae of the theory of relativity are not applicable when the velocity of object approaches or reaches the light speed, because in that case, the density of ether becomes very large. In the ether theory, the super-light speed is acceptable as the ultrasound speed. The atmospheric density will reach a maximum in the ultrasound movement, so, the mass (the variation of ether density) of a super-light object will also not be infinite.

In considering the gravitational effect of the space-time, the space is turned into a Riemann space. Here the space is bent, but the bend only means that the distribution of ether is not even. On the other hand, the gravitational field is only the field of the ether density, which means that the gravitation is a property of ether continuity, which will disappear when the ether density is small enough, that is to say, the range of gravitational interaction is finite. The modern cosmology regards the equations of gravitational field of the general theory of relativity as the cosmic equations, thus takes the Riemann space as the real space and the range of gravitational interaction as being infinite, where come all the cosmological knotty problems. There are the three elements in modern cosmology: inflation, dark matter and dark energy. Perhaps they do not really exist just like the epicycle and deferent in the Ptolemaic geocentric theory. They are just being fabricated to explain something that people can not explain otherwise.

In a word, the theory of relativity is only a theory of macrophysics, has certain limitations and can not used to describe the whole cosmos.

References

- [1] Yi Yuan and Kang Xiaoyu, *Research on Smarandache problems*(in Chinese), High American Press, 2006, P106-115.
- [2] Changwei Hu, The theory of gravitational field ether(in Chinese), *The Contemporary Thought Treasure Of China*, The People's Daily Publishing House, Beijing, 2005, P633.
- [3] *The Collected Works Of Einstein*(in Chinese), Beijing, Commercial Press, 1977.
- [4] Xiaozhou Xue, *The Guide About the Quantum Vacuum Physics*(in Chinese), Science Press, Beijing, 2005, P17.
- [5] Yuanzhong Zhang, *The Experimental Basis Of Special Relativity Theory*(in Chinese), Science Press, Beijing, 1979, P61-65.

Quantum External Force and Unified Universe

Luo Zhengda

(Sichuan Jingsheng Group Limited Company, Yibin, 644000, Sichuan, P.R.China)

Abstract: The universe is made of matter and it is the existence of matter that determines the existence and evolution of the universe, which accounts for all kind of phenomena in the universe. Due to the invariability of the total quantity of matter, we have the invariability of the speed of light. The field of matter leads to the force field. The unification of the universe is based on the unification of the matter field. The quantum external force (inertia external force) is the First Cause of the universe. The detailed description is given for the mechanical characteristics of quantum external force (inertia external force), the explanation of the universe phenomena is made with the quantum theory, and the material nature of the universe is discussed. Since the dark matter and the dark energy have an objective existence, they must belong to the category of matter, and have the attributes of matter. According to the generalized materialistic view and the classification of matter by the degree of vision, we may call the ordinary matter in universe and the dark matter composed of unknown particles as the visible matter; the dark energy (non-particle state of matter) in universe as the invisible matter. The quantum external force (inertia external force) and the quantum repulsion (inertia repulsion) are the manifestation of “force” attribute of invisible matter. The invisible matter is the carrier of the absolute time, with no beginning, nor end point; and on the other hand, the visible matter is the carrier of the relative time. Using the quantum external force principle based on the attributes of *force* of invisible matter, and with the help of Smarandache Multi-Space Theory, we can explain some new astronomical observation discoveries and other riddles that have not yet been solved the perihelion precessions of the nine planets in solar system also can be handled simultaneously.

Key words: Inertia external force, quantum external force, unified universe, first cause of universe, dark matter, dark energy, Smarandache multi-spaces.

This paper summarizes the unified universe, the principle of inertia external force, the quantum external force, the First Cause of universe, the invisible matter, the dark energy and so on.

1. Unified universe and the principle of inertia external force

From the ancient time to present, the people have never stopped the exploration on the mysterious universe. After entering the 20th century, the people started to observe the universe with the help of the high technology. According to the observed results, several representative universe evolution models have been proposed one after another, such as those of *steady-state universe model*, *hierarchic universe model*, *matter and antimatter universe model*, *static universe model*, *dynamic universe model*, *strangeness collapse universe model*, *expanding universe model*, *smooth universe model* and *big bang universe model*, \dots , etc.. The goal of a theoretical model is to make a perfect explanation of various mysterious phenomena of universe and to answer related scientific questions. Because the above-mentioned theoretical models all based on the *universal gravitation*, naturally, they may not be able to explain the mystery of the whole universe.

In reference [1], the author carries out systematic studies on the mechanical structure of universal celestial body, some special structures and astronomical phenomena in universe from a new point. It is believed that the microscopic world and the macroscopic world are a dialectical unity; any matter is composed of visible matter and invisible matter (halo). The scope of materialistic existence or the scope where matter takes effect must be much greater than the scope where people observe. The astro-space is filled with matter of various shapes, as a richly colorful universe world. All hidden halos are superimposed infinitely, and mutually affected to form an isotropic entire circumferential inertia external force (the greater force). From the matter of various shapes with its interactions among itself, a repulsive force of different levels (the less force) forms with its own core as the center. Its manifestations are *the apple falls to the ground due to the inertia external force*, *the sunlight is emitted due to the sun's repulsive force*. The exchanges of matters are through the halos. The halo interaction principle is the roller principle, the matter transfers and transforms in a manner of entering through latitude and exiting through pole.^[1]

The application of the principle of inertia external force requires the help of some effective mathematical tool, and the Smarandache multi-space theory is just such an effective mathematical tool.

The notion of Smarandache multi-space was proposed by Smarandache in 1969^[4].

A Smarandache multi-space is a union of n different sets or spaces equipped with some different structures for an integer $n \geq 2$, which can be both used for discrete or connected spaces, particularly for geometries and space-times in theoretical physics.

Let S_1, S_2, \dots, S_k be distinct two by two structures respective on the distinct (not necessarily disjoint) two by two sets M_1, M_2, \dots, M_k , where $k \geq 2$ (k may even be infinite). We define a multi-space M to be a union of the previous sets

$$M = M_1 \cup M_2 \cup \dots \cup M_k.$$

Hence, we have k different structures on M . For example we can construct a geometric multi-space formed by the union of three distinct subspaces: *an Euclidean, a hyperbolic and an Elliptic one.*

By combining the principle of inertia external force with Smarandache multi-spaces, we can explain some new astronomical observation discoveries and the riddles that have not yet been solved.

It is hoped that the *principle of inertia external force* and the *unified universe* may serve as an introduction for more scholars to propose scientific questions, to solve difficult problems, and to break through the tradition, experience and visions. It is also hoped that the general public of insight can take part in the exploration of the mystery of the vast and infinite universe, and in the development of science and technology.

Now we discuss how to use these Smarandache multi-spaces to handle the perihelion precessions of the nine planets in solar system simultaneously.

In reference [6], Suppose the space of universe is filled the invisible matter (quantum outside force field), and the quantum external force travels at the speed of light; as two stars run the relative motion at the speed of v , the equation of quantum external force field can be written as:

$$U(x, y, z, t) = K \iiint \frac{\rho(x', y', z', t') d\tau'}{r'} = K \iiint \frac{\rho(x', y', z', t - r'/u_r) d\tau'}{r'} \quad (1)$$

where, $u_r = c + v_r$; r' is the distance from the spherical surface to the central point and u_r is the speed that the spherical surface sweeps the star.

Because the star size is far smaller than the distance between two stars, therefore, Eq.(1) can be written as:

$$U(x, y, z, t) = \frac{K}{r'} \iiint \rho(x', y', z', t - r'/u_r) d\tau' \quad (2)$$

By using Eqs.(1) and (2), the precession angle of one hundred years $\Delta \theta^{100}$ is

$$\Delta \theta^{100} = 6\pi \frac{KM}{c^2 a(1-e^2)} N = 42.9''$$

The observation value of the perihelion precession of Mercury equals $43.11'' \pm 0.45''$, we can see that the calculated result of the perihelion precession of Mercury given by the theory of quantum external force agrees with the observation value of the perihelion precession of Mercury.

As handling the perihelion precessions of the nine planets in solar system simultaneously, the actions between the planets also can be considered simultaneously. Therefore, we define a Smarandache multi-space M to be a union of 45 sets $M_{01}, M_{02}, \dots, M_{09}, M_{12}, \dots, M_{19}, M_{23}, \dots, M_{29}, \dots, M_{78}, M_{79}, M_{89}$):

$$M = M_{01} \cup M_{02} \cup \dots \cup M_{89},$$

where M_{01} denotes Sun-Mercury system, M_{02} denotes Sun-Venus system, \dots , M_{09} denotes Sun-Pluto system, M_{12} denotes Mercury-Venus system, \dots , M_{19} denotes Mercury-Pluto system, M_{23} denotes Venus-Earth system, \dots , M_{29} denotes Venus-Pluto system, \dots , M_{78} denotes Uranus-Neptune system, M_{79} denotes Uranus-Pluto system, M_{89} denotes Neptune-Pluto system.

Thus, by applying the Smarandache multi-spaces, the perihelion precessions of the nine planets can be handled more accurately.

2. The quantum external force and the first cause of universe

The reference[1]entitled with *Unified Universe - The Principle of Inertia External force* was published in 2001. Since then, the author have received massive letters from readers of all circles as an encouragement.

In the correspondence discussions, it was generally understood that reference [1] has established a new and consistent universe model and concept of the world. But it is a difficult book, because of many new concepts in the book and because some traditional terminology has been given new connotations, where more explanations are in order. It is true that the theory has predicted that there is water on Mars, which has been confirmed by observations, but it is expected that the new theory can explain more universal riddles which have not been solved. As the foundation of the new theory is matter, it is hoped that the author can further elaborate and explain the materialistic characteristics of inertia external force.

The central ideas in this book were: (1) *the universe is made of matter and it is the existence of matter that determines the existence and evolution of the universe which accounts for all kind of phenomena in the universe*; (2) *due to the invariability of the total quantity of matter, we have the invariability of the speed of light*; and (3) *the field of matter leads to the force field, and the unification of the universe is based on the unification of the matter field*. If there is an *ultimate unified field*, this ultimate unification field must be the field of inertia external force, and the inertia external force is the first cause. Based on that, this section discusses the materialistic nature of the universe from the viewpoint of quantum theory. From a study on the history of the universe research, especially, the profound understanding of the cosmism in Chinese ancient times, a conclusion is made that the cradle of the quantum theory for universe matter should be in China, and the *vitality theory* should be the primitive and classical existence field theory. Another key point of this section is to give a philosophical explanation of the vacuum, which is only the space filled with various kind of micro-particles that people cannot detect by the existing technology. In the reference [1], the celestial bodies are classified into several representative levels according to the clustering scale of matter, with the quark level of celestial bodies corresponding to the smallest clustering scale of matter, which is the smallest visible celestial body formed through the transfer of energy to mass under the arbitrary shrinking action of quantum external force field. In other words, the smallest visible celestial bodies are being produced ceaselessly on an arbitrary point in the astrospace. The clustering of matter of the smallest visible celestial bodies is the origin of a celestial body, also is the material source of the existing celestial body. Therefore, the *singular point* is not the origin of universe. But it may explicitly point out that the quark is not the smallest form of universe matter. Just like what an ancient Chinese philosopher Gongsunlong once said: For a rod of one foot long, taking one half of it away a day, we will not exhaust the rod for however long time. In the universe, matter exists in two forms, i.e., visible matter (mass) and invisible matter (energy). The hidden halos (epicycle) and infinitely clustering of the hidden halos (epicycle) will produce the mass-energy radiation, mass-energy exchange and mass-energy superimposition with disturbance and intensity from strong to weak, that constitutes the universe background radiation. In other words, the universe is filled not only with visible matter (mass), but also with invisible matter (energy). This section is a more detailed elaboration of topics in the reference [1], with simpler language, of the mechanical characteristics of inertia external force (quantum external force), gives explanations to the universe phenomena with the quantum

theory, and helps the interested readers to share more fully the author's thought and viewpoint.

Things in universe are very complicated and are ever changing. But with the Smarandache multi-spaces, problems in different domains can be studied in a single background. For example, we may put visible matter (mass) and invisible matter (energy) in a single space, and study them in a way, that it will be difficult to do so with other theories.

Just like a Britain scholar H. Pulais once said: Because all the physicists and philosophers have not realized, the field of vision for us to regard the world usually, actually is the production of our asymmetrical viewpoint, the most far-seeing understanding of quantum mechanics has been nearly neglected. I quite agree with the proposal presented by a scholar Mr. Zeng Jinyan^[2]: All theories must be judged in the front of the judge of practice for its truthfulness. We maintain that we must not deny the knowledge handed down by our ancestors rashly, nor accept it blindly.

3. The invisible matter, dark energy and quantum external force

Since researchers of modern science on universe proposed the guess that in the universe there may exist dark matter and dark energy, the task of finding the existence evidence of dark matter and dark energy has become a hot topic for the astronomy research. There are now different characteristic understanding for dark matter and dark energy. Some scientists hold that dark matter and dark energy are not matter, but energy in some form. Others hold that dark matter and dark energy are some unknown particles. In other words, there exist different viewpoints about dark matter and dark energy. We are left with many unsolved riddles concerning dark matter and dark energy.

After the studies of dozens of years, in the year 2003 a famous magazine *Science* in USA listed the existence of dark matter and dark energy in universe as the first of the ten big scientific and technical breakthroughs of the year, which indicates that the scientific circles have publicly acknowledged and affirmed for the first time that there truly exist dark matter and dark energy in universe. The new scientific evidence shows that the major part of the universe are composed of *dark matter* and *dark energy*, and dark matter is mangled by the unknown force called dark energy. It is calculated that in universe the ordinary matter only constitutes 4% of the content, the dark matter 23% (Note: astrophysicists believed that dark matter is composed of still unknown particles), and another 73% is the dark energy. Some scientists believed that, though one cannot see dark matter, it has gravitation; and, on the

other hand, one can not see dark energy, and nor it has gravitation, therefore, it cannot be called matter. At present the astronomers believe that dark energy plays a role of repulsion force in universe, but strictly, one can not say it is a repulsion force, it can only be called energy. Then

is the energy a kind of matter?

Philosophically speaking, since dark matter and dark energy exist objectively, they are matter and have the attribute of matter. According to the generalized view on matter and the classification by the degree of vision, we have the ordinary matter (which constitutes 4% of the content) in the universe (which may be understood as the macroscopic celestial bodies, such as the star, planet and the like), dark matter (which constitutes 23% of the content) composed of unknown particles (it may be regard as the microscopic celestial bodies which spread in universe space), which may be jointly called visible matter and we have also dark energy (which constitutes 73% of the content, is matter in non-particle state), which may be called invisible matter. Since dark energy is invisible matter, it is different from visible matter (macroscopic celestial bodies, microparticle and so on). The unique invisible nature of invisible matter requests us to have a brand-new materialistic view with respect to cognition. If we still follow the traditional materialistic view on dark energy, thinking that dark energy is also composed of some elementary particles and attempt to reveal the nature of dark energy through finding its composing elementary particles, there would be no results just like the search of *graviton*.

The author considers some questions, beginning from the most popular topic in current astronomy circle on the dark energy, discussing the materialistic attributes of dark energy and the force attribute, through explanations of some universe phenomena, and elaborating the author's viewpoints.

The author's purpose is to establish a new materialistic view and to study the material world around us with the new angle of view. In this paper, we start from a discussion on matter in universe, further expound the importance to divide matter into visible matter and invisible matter in a macroscopic context, propose a generalized materialistic view, explicitly point out that the visible matter is what people can see, with shape, structure, mass and movement track; and the invisible matter is what people cannot see without material shape, structure, mass and movement track, which cannot be detected and observed by using instrument and fills the universe space in the form of energy. The quantum external force (inertia external force) and the quantum repulsion force (inertia repulsion force) are the manifestation of

force attribute of invisible matter. The superimposition of quantum repulsion force establishes the full state of quantum external force, which carries out the task of imprisoning, surrounding, contracting and driving visible matter (celestial bodies), and which focuses in its geometry center, to form a focus confrontation, to make radiations of visible matter by quantum repulsion, and to form the quantum repulsion field (halo, epicycle) with visible matter (celestial body) as the center. The correlation between the quantum external force and the quantum repulsion force, is not a simple circulation of force, but is an inevitable result.

Here, various forces and fields are involved, jointly. It seems that the situation is extremely complicated. As a matter of fact, it can be very simple handled by applying Smarandache multi-spaces. We may understand and simultaneously solve problems related to quantum external force, quantum repulsion force, quantum repulsion field (halo, epicycle), as well as imprisoning, surrounding, contracting, driving and so on.

For some questions, from beginning to end, the author always puts the emphasis on the mutual relationship between the movement of visible matter (celestial body) and the action of invisible matter (dark energy), in order to indicate the integrity, the materialistic nature and the general nature of the mutual relationship in universe. At the same time, the author links the concept of invisible matter and visible matter with time, namely, the absolute time and the relative time; it is pointed out that invisible matter is the carrier of the absolute time, with no beginning and end point; while visible matter is the carrier of the relative time, which has broadened our understanding of the time concept, enriched its connotation from a mere measurement parameter to record the "course" of thing or matter, or the length of life and so on. The universe used to be described to be composed of *matter, space and time*. But now it may be composed of *visible matter and invisible matter*. The space is materialistic, is composed of invisible matter and filled with dark energy. This is the generalized materialistic view of the universe.

Now, we elaborate the mutual transformations and movement of visible matter (celestial body) and invisible matter (dark energy), namely, the two kinds of remarkable trends of transformation: (1) *entering through latitude and exiting through pole* and (2) *entering by the quantum external force three-dimensionally and exiting by the quantum repulsion force three-dimensionally (entering by the greater force and exiting by the less force)*. Through the mutual action and counter-action between the quantum external force and the quantum repulsion force, and the mutual action and counter-action among the quantum repulsion forces, we may explain all kinds

of phenomena related to celestial bodies in the process of transformations of matter, such as the black hole, the supernova eruption, all kinds of beam eruption and so on, to show that the phenomena, such as the 3K microwave background radiation, chemical element abundance, galaxy spectrum red shift and the like, are the natural results of the transformation between mass and energy, hereby to show that the above mentioned phenomena are not caused by big bang; From this, it may be concluded that the essence of universe expansion and contraction is the movement, i.e., the transformation of mass and energy. Finally, it shown that there are universe expansion and contraction at the same time, a realistic universe is in a dynamical equilibrium, with *no beginning and end point* in perpetual motion and the process of transformation between mass and energy at all the time.

For some questions, we start from the generalized materialistic view, elaborate the materialistic attribute of quantum external force, point out that the quantum external force is invisible matter (dark energy), with its source being the repulsion of visible matter, and the superimposition of repulsion forces. The existence of Newton's universal gravitation depends on the existence of the celestial bodies, in other words, we first have the celestial bodies, and then we have the universal gravitation, or we will not have the universal gravitation without the celestial bodies. Einstein's gravitational field equations, with a basis on the classical mechanics, say that celestial body is related to gravitation, on one hand, and also say that the celestial body itself does not mean the gravitation, which is the space-time curvature caused by the mass of body, which can explain many phenomena (ideas) of the gravitation (field). Both of them are gravitational theories, but they are not totally alike, which is noticed by serious scientists. The key lies in the materialistic attribute of Newton and Einstein's gravitation. To compare the universal gravitation and the quantum external force, it can be seen that the quantum external force has the obvious materialistic attribute, i.e., invisible matter, but the universal gravitation does not have that materialistic attribute. With the universal gravitation, we can not see things very clearly, like *looking flower in fog*, which is the basic reason why for nearly 300 years people can not explain the universal gravitation clearly. Generally speaking, the quantum external force and the universal gravitation both are the force existing anywhere in universe, one is called the external force, another is called the gravitation, the different wording leads to entirely different results. Comparing the external force with gravitation, it can be seen that the concept of external force is much more general than the concept of gravitation, and it not only can explain all phenomena that gravitation can explain, but also can explain many phenomena

that gravitation cannot explain.

Now, based on the contraction of the quantum repulsion and the expansion of the quantum external force, the author explains how the quantum external force affects the celestial bodies, leads to the mutual resistance of the celestial bodies and forms the ellipse repulsion field, as well as the basic shape of the ellipse repulsion field and how the planet moves in the ellipse repulsion field. After the German astronomer Kepler discovered in 1609 that the planet movement track is an ellipse, with their respective gravitation theories, Newton and Einstein explained how the planet moves around a fixed star on the elliptical orbit, but they did not directly give the reason of the elliptical orbit, and the reason for the directions of the elliptical orbit's major axis and minor axis (for the concepts of major axis and minor axis, see the mystery of galaxy red shift in the fourth section of the third chapter). Based on the relationship between the mutual action and mutual counter-action of the quantum external force and the quantum repulsion force of the celestial bodies, this book not only explains the formation of the celestial body's elliptical orbit and the directions of the elliptical orbit's major axis and minor axis, but also explains how the planet makes the spirally gradually precessive transversal motion around a fixed star. In this chapter we can understand the rules of the movement of the universal celestial bodies, believe that the quantum external force is the First Cause of universe.

Here, the precession of the earth axis is explained. It is shown that the Earth makes a spiral gradual precession around the sun under the action of the quantum external force, and following the sun moves around a galaxy (the concept of a galaxy is explained in the first section of the sixth chapter), that leads to the earth's radial and transversal (latitude) precessions to form a resultant moment, responsible for the Earth annual solar terms (towards the west). And because the galaxy determines the earth axis direction, and the earth axis rotates clockwise, we have the earth axis precession.

Now, the formation mechanism of the celestial body's ellipse repulsion field is analyzed, with a discussion on the universal multistage four seasons, namely, the succession of the earth's four seasons as the result of the earth's movement in the solar ellipse repulsion field (the succession of the earth's four seasons follows the movement of the sun in the galaxy's ellipse repulsion field; the succession of the earth's four seasons follows the movement of the sun in the asterism's ellipse repulsion field; the succession of the earth's four seasons is explained in a range greater than the galaxy group). From that observation, the earth's palaeo-climatology formation and

the earth future climate changing tendency can be analyzed.

It would be an interesting task using the principle of the quantum external force established by the force attribute of invisible matter to explain some new astronomical observation discoveries and the riddles that have not yet been solved, although only a limited number of examples are discussed in the book, like the tip of the iceberg. To apply the theory into the practice not only is the goal of theoretical research, but also can make the theory clearer. In the ninth chapter, the correlation between some astronomical phenomena in the solar system and the sun is discussed, to show that when a planet occupies a different position in the solar ellipse repulsion field, due to the difference of the magnitude of the mutual repulsion resistance, we will see different planet astronomical phenomena. The sun can influence the planet, similarly, the planet can also influence the sun.

The universe is composed of matter, the universe is unified by matter (visible matter and invisible matter). The dark energy is invisible matter, the quantum external force and the quantum repulsion force are the manifestation of force attribute of invisible matter (energy). The mutual action and counter-action of the quantum external force and the quantum repulsion force, and mutual action and counter-action among the quantum repulsion forces, constitute the universal mechanical framework and the basis of movement in the universe, and explain the movement track of celestial bodies, and also all kinds of celestial phenomena in universe, such as the transformation of the universal matter, universal expansion and contraction, universal *black hole*, supernova eruption, earth axis precession, the succession of the four seasons and so on. These are the prevalent relations and the logical consequences.

References

- [1] Zhengda Luo, *Unified Universe - The Principle of Inertia External Force*, Sichuan Science and Technology Press, 2002.
- [2] Zhengda Luo, *The Quantum External Force - The First Cause of Universe*, Sichuan Science and Technology Press, 2003.
- [3] Zhengda Luo, *The Invisible Matter - The Dark Energy and the Quantum External Force*, Sichuan Science and Technology Press, 2005.
- [4] F.Smarandache, Mixed noneuclidean geometries, *eprint arXiv: math/0010119*, 10/2000.
- [5] F.Smarandache, *A Unifying Field in Logics- Neutrosopy: Neutrosophic Proba-*

bility, Set, and Logic, American Research Press, Rehoboth, 1999.

- [6] Zhengda Luo and Yue Zhou, *Equation of Quantum External Force Field*, to be published.

New Analysis on the Relativity of Simultaneity

Hao Ji

(Oriental Electromagnetic Wave Research Institute, Shanghai 202155, P.R.China)

Abstract: This paper points out that the reasoning process of the relativity of simultaneity in *On the electrodynamics of moving bodies*^[1] by Einstein in 1905 contains some errors and applies the proof method used by Einstein himself to design a thought experiment for its disproval. It is shown that the simultaneity is absolute instead of relative as was asserted by Einstein. With the idea in the Neutrosophy, this paper's result is explained and discussed.

Key Words: Simultaneity, theory of relativity, relativity, neutrosophy.

1. Introduction

It is now over one hundred years since the theory of relativity came into being, but it still attracts attentions of many scholars, especially owing to its disputable propositions. A series of contradictive results (so-called paradoxes) are deduced from its two basic hypotheses, i.e., principle of relativity and principle of invariance of light speed, which have been widely studied since they were proposed. The theory of relativity is considered to be not perfect even wrong by some scholars.. Some famous paradoxes include clock paradox, fall paradox and submarine paradox. A good question may help people to reconsider various aspects of a theory and even lead to a new breakthrough. The author applies the thought experiment used by A. Einstein himself to design a thought experiment for its disproval, which shows that the simultaneity is absolute instead of relative. Therefore, the theory of relativity encounters difficulties when it is used to explain this thought experiment, and more studies on the theory of relativity are necessary.

In order to carry out such thought experiment, the method of Neutrosophy is used. As we known, the Neutrosophy is proposed by F.Smarandache in 1995. It is a

new branch of philosophy that studies the origin, nature, and scope of neutralities, as well as their interactions with different ideational spectra.

This theory considers every notion or idea $\langle A \rangle$ together with its opposite or negation $\langle \text{Anti} - A \rangle$ and the spectrum of *neutralities* $\langle \text{Neut} - A \rangle$ (i.e. notions or ideas located between the two extremes, supporting neither $\langle A \rangle$ nor $\langle \text{Anti} - A \rangle$). The $\langle \text{Neut} - A \rangle$ and $\langle \text{Anti} - A \rangle$ ideas together are referred to as $\langle \text{Non} - A \rangle$.

Neutrosophy is the base of neutrosophic logic, neutrosophic set, neutrosophic probability and statistics used in engineering applications (especially for software and information fusion), medicine, military, cybernetics, physics.

Neutrosophic Logic(NL) is a general framework for unification of many existing logics, such as fuzzy logic (especially intuitionistic fuzzy logic), paraconsistent logic, intuitionistic logic, etc. The main idea of NL is to characterize each logical statement in a 3D neutrosophic space, where each dimension of the space represents respectively the truth (T), the falsehood (F), and the indeterminacy (I) of the statement under consideration, where T, I, F are standard or non-standard real subsets of $] -0, 1+[$ with not necessarily any connection between them.

For details about the Neutrosophy, readers are referred to references [7-9].

2. Analysis of A. Einstein's proof

The author will point out some mistakes in the proof of the proposition of relativity of simultaneity in the paper *On the electrodynamics of moving bodies* of A. Einstein in 1905.

In the reference [3] page 36, it is stated that *the observer moving with the moving rod will discover that the two clocks are not synchronous*. To follow the theory of relativity, we should join the observer moving with the moving rod to judge the whole event. When light propagates from A to B at time t_A , and is reflected from B at time t_B , and returns to A at time t'_A . In the author's opinion, since the observer is moving with the moving rod, the moving rod is in rest, as far as the observer is concerned. The distance from A to B is equal to the distance from B to A . According to the principle of invariance of light speed, the light speed is also c in the reference system moving with the moving rod, so

$$t_B - t_A = \frac{r_{AB}}{c}, t'_A - t_B = \frac{r_{AB}}{c} \quad \text{namely,} \quad t'_A - t_B = t_B - t_A.$$

Therefore, the demonstration by A. Einstein is incorrect.

Secondly, in order to adjust the clock, in the reference [3] page 35, A.Einstein said that *a clock is set on both sides of the rod, and they are synchronous with the clocks in static system, namely, at any instant the clock's indicators are pointing to the static system time at its respective location at it happens, so the two clocks are also synchronous in the static system.* In the author's opinion, this statement is also wrong, because when the synchronous clocks in static system are moved to the moving rod, there must be an accelerated and decelerated process, and according to the theory of relativity, the clock's speed in a moving system is different from that in a static system. So the statement of A. Einstein that the two clocks are synchronous with the clocks in a static system is wrong, as a famous scientist said that A.Einstein proves his theory of relativity by classical theory.

According to the Neutrosophy, when all the possible situations are considered, Einstein's famous proposition of relativity of simultaneity should be represented, respectively, as the truth, the falsehood, and the indeterminacy of the statement under consideration.

We already show that Einstein's proof of the proposition of relativity of simultaneity in his paper of 1905 is incorrect in many aspects. Therefore, for the case considered by Einstein, the proposition of relativity of simultaneity is 0% true, 0% indeterminate, and 100% false. It may be written as (0, 0, 1). But in other cases, this proposition may be correct or wrong. Therefore we may make a guess that the proposition of relativity of simultaneity may be 33.3% true, 33.3% indeterminate, and 33.3% false. It may be written as (0.333, 0.333, 0.333). For a more accurate estimation, a further study is necessary.

3. Thought experiment for disproval

3.1. The proof method used by A. Einstein himself^[2] is adopted, see Fig.1

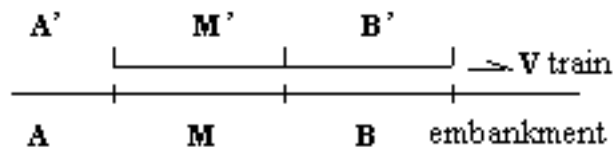

Fig.1

Judging from the train reference system, the train is in rest, while the embankment is moving. When **AA'**, **BB'** and **MM'** coincide, **AA'**/**BB'** will flash at the same time and reach **M'** at the same time. It should be noted that all above events are defined according to the observer in the train reference system. We consider the two events

that two light rays reach M' at the same time, as judged by the observer in the train reference system. According to the observer in the embankment reference system, the embankment is in rest, while the train is moving, and in order to consider the effect of the theory of relativity, it is assumed that the running speed of train is $v = \frac{\sqrt{3}}{2}c$. When it is decided that A and A' coincide in the train reference system, the observer in the embankment reference system will make a judgment as those shown in Fig.2



Fig.2

When the observer in the embankment reference system observes that A and A' coincide and flash, B' is still far away from B , so A will flash before B . But calculation shows that when the light from A reaches M , the light from B reaches M at the same time (it should be noted that all above calculation is made according to the observer in the embankment reference system). Thus similar to the two events that two light rays reach M at the same time defined according to the train reference system, one can also judge that the two light rays reach M at the same time according to the embankment reference system, therefore, it is concluded that simultaneity is absolute.

3.2 In the above mentioned considerations and the reasoning by A. Einstein, one may ask a question, namely, both will not acknowledge the two light rays are emitted at the same time. In order to avoid this question, the author carries out another thought experiment, see Fig.3

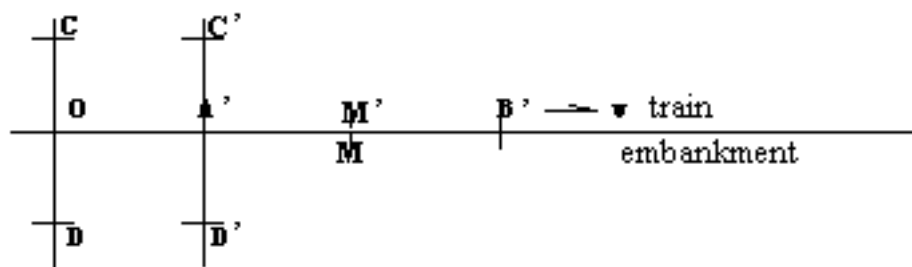

Fig.3

Choose two points C and D that are in axial symmetry with respect to the embankment, the middle point is O ; two points C' and D' located at two sides of train are in axial symmetry about A' . When the point A' on train coincides with O , C'

with C , D' with D , $C'(C)$, D'/D will flash together at the same time and the two flashes are in simultaneity both according to the embankment reference system and according to the train reference system. Will the two flashes both reach M' at the same time and both reach M at the same time? It is very easy to prove that they are in simultaneity according to the train reference system and they are also in simultaneity according to the embankment reference system, hereby, it is proven that the simultaneity is absolute.

4. Discussion

There are many scholars in China challenging the theory of relativity and many papers on relativity of simultaneity, and few of them are very reasonable, but some of them have raised various questions. Is the simultaneity relative or absolute? Just as P.G Bergman said that our definition about the simultaneity is arbitrary to a great extent. The simultaneity is relative sometimes while it is absolute in other times, because it does not play a key role in deciding the validity of the whole system of the theory of relativity. To validate or invalidate the theory of relativity, one has to carry out the following experiments: (1) *Whether or not the speed of unilateral light is a constant*; (2) *Whether or not the principle of relativity is correct*; (3) *Whether or not the moving clock will be slower*; (4) *Whether or not the length of moving body will shrink*; (5) *Whether or not the mass of moving body will increase*. In the author's opinion, during the time of more than 100 years since the publication of the theory of relativity, one sees a great progress of science and technology, and now it would be possible to prove experimentally whether or not the moving clock will be slower and the mass of moving body will increase. The author pointed out in reference [6] that, the proposition about mass increase with speed increase in the theory of relativity proposed by A. Einstein is problematic. Therefore, in the author's opinion, the theory of relativity is not a perfect theory.

References

- [1] A.Einstein, On the electrodynamics of moving bodies *Ann Physik*, 17(1905).
- [2] A.Einstein, *Elementary Introduction of Special and General Theory of Relativity* Shanghai Science and Technology Publishing House, 1964.
- [3] A.Einstein, et al, *Principle of Relativity*, Beijing Science Press, 1980.
- [4] *Corpus of A.Einstein*(second volume) *Translated into Chinese by Fan Dainian*, Beijing Commercial Press, 1977.

- [5] P.G Bergman, *Introduction to Theory of Relativity*, Beijing People's Education Press, 1961.
- [6] Hao Ji, On experiment that measures the momentum-energy relation of moving electrons, *Engineering Science*, (10)2006, 60-65.
- [7] F.Smarandache, *A Unifying Field in Logics: Neutrosophic Logic- Neutrosophy, Neutrosophic Set, Neutrosophic Probability and Statistics*(third edition), Xiquan Publishing House, Phoenix, 2003.
- [8] F.Smarandache, V. Christianto, Fu Yuhua, R. Khrapko and J. Hutchison, *Unfolding the Labyrinth: Open Problems in Mathematics, Physics, Astrophysics, and Other Areas of Science*, Hexis,Phoenix, 2006.
- [10] D. Rabounski, F. Smarandache and L.Borissova, *Neutrosophic Methods in General Relativity*, Hexis, 2005.

Applying Neutrosophy to Analyze and Remould the Special Theory of Relativity

Xinwei Huang

(Equipment Department, Dongfeng Motor Corporation Frame Plant, Shiyan 442000, Hubei, P.R. China)

E-mail: mydisk@sina.com

Abstract: This paper uses neutrosophy to analyze and remould the special theory of relativity. It puts forward lever and elevator antinomies, cites the breakthrough of GZK limit for ultrahigh energy cosmic radiation rays and proposes some questions on the principle of relativity. It proposes a new theory of *five-dimensional space-time and dynamics* which does not need and recognize the principle of relativity, and using this theory, it simply explains some phenomena such as the increase of mass and the slow down of time when a matter particle is acted upon a external force to move, and deduces the mass-energy formula: $E = mc^2$. It gives a new explanation to these phenomena and thinks that mass is the object's intrinsic attribute just as electric charge, which has nothing to do with the relative speed of the observer's. This theory has put an end to all paradoxes in the special theory of relativity and explains the breakthrough of GZK limit for ultrahigh energy cosmic radiation rays. This paper proposes a new question to prove that there must be an absolute rest reference frame, and infers that the cosmic microwave background radiation field is just the absolute rest reference frame.

Key words: Lever antinomy, elevator lift antinomy, GZK limit, mass, the principle of relativity, five-dimensional space-time, absolute rest reference frame, cosmic microwave background radiation field.

1. Introduction

The *Neutrosophy* is a new branch of philosophy, introduced by a Romanian-American mathematician F.Smarandache in 1995, which studies neutral thought. The word *neuter* was derived from French and Latin, meaning neutral and *sophia* comes from

Greek, meaning skill and wisdom. Whence, *Neutrosophy* studies the origin, nature and scope of neutralities, as well as their interactions with different ideational spectra. Standing on the position of joint Eastern and Western cultures, in the perspective of the unity of opposites, it bases its exploration of every macro and micro structure from science and technology to literature and art to construct a unifying field, which surpassed all the sciences and the boundaries between natural science and social science, to solve the indeterminacy problem that universally appears in current cognitive science, information science, system science, economics, quantum dynamics and so on. Its fundamental is based on that *any idea is $T\%$ true, $I\%$ indeterminate, and $F\%$ false.*

2. Using neutrosophy to analyze the theory of special relativity

Special relativity was born more than 100 years ago. As a successful theory, it has been written into physics textbooks in all the countries. In the eyes of ordinary people, the theory of special relativity has been proven by lots of experiments, and its accuracy is beyond doubt.

Is this really true?

While using neutrosophy to analyze the theory of special relativity, it is affirmatively $T\%$ true and can reflect the basic law of motion in a certain extent. Otherwise, it would not be accepted by the physical community, and written into physics textbooks.

However, does the theory of special relativity also follow the fundamental thesis of neutrosophy, i.e., any idea is $I\%$ indeterminate and $F\%$ false?

The author believes that the theory of special relativity is affirmatively $I\%$ indeterminate and $F\%$ false!

The authenticity of the theory of special relativity is first reflected in its mass energy formula . The atomic bombs and nuclear power stations are the actual applications of the mass energy formula. Therefore, the theory of special relativity is $T\%$ true.

One of the indeterminacies in the theory of special relativity is the mass-velocity relation . Despite high-energy physics experiments can prove this relation in a certain extent, but the observers of these experiments are in the ground reference system. If the observers are in the state of motion comparing to the ground, is the mass-velocity relation still valid? No experiments have proved that point, so the theory of special relativity is $I\%$ indeterminate.

The falsity of the theory of special relativity is reflected in its contradictory, such as Twin Paradox, Rockets-and-string Paradox, Right Angle Lever Paradox, Ehrenfest Paradox, Godel Paradox etc. These paradoxes reflect that the theory of special relativity is wrong in a certain extent. It can be said that the theory of special relativity is $F\%$ false.

3. Questions on Special Relativity

Here, the author proposes several self-reflective questions for us to look at the crux of the problems for Special Relativity.

(1) A, B particles are relatively at rest in the beginning, and then A moves after an external work (such as photon impact or electric-field force) acts upon it. A's mass will increase as seen from B, which is easy to explain, because A has got the energy from outside, and in accordance with the mass-energy equation $E = mc^2$, A also has got the mass from outside at the same time. Then, as seen from A, will B's mass also increase? According to Special Relativity, B's mass will also increase. However, B has not been acted upon by an external work, so B has never got the energy and mass from outside. A and B have experienced two absolutely different physical processes. What reasons are there to believe that A and B could see the same result that their mass will both increase?

(2) An object and an observer are relatively at rest in the beginning, and then the observer begins to move. According to Special Relativity, the observer will find that the object will move relatively, and its mass will also increase. Then, where does the increased mass come from?

Now the observer stops moving and returns to the starting state. According to Special Relativity, the observer will find that the object will change from "motion" to "at rest", and its mass will reduce. According to Special Relativity, there must be a release of energy with a change of mass. Well, where has the energy released by the object gone?

(3) Lever antinomy As shown in Fig.1, there is a long horizontal lever on the ground, and on its intermediate point there are two objects A and B with the same rest mass (m_0) and the same speed v move towards the left and right ends of the lever respectively at the same time.

The observer at rest on the ground will find that both A and B objects' mass will increase to M . The distance from them to the intermediate point of the lever are equal at any one time, so the lever always maintains a balance.

However, as seen from another observer in an inertial system moving from left to right in a uniform rectilinear motion with the velocity v , B is at rest and A is in motion, so A's mass is heavier than B's.

Then, has this observer found that the distance from both A and B to the intermediate point of the lever are equal at any one time? According to Special Relativity, the observer on the ground will find that the distance from both A and B to the intermediate point of the lever are equal at any one time. After a transformation into an inertial system in motion by a Lorentz transformation, the distance from both A and B to the intermediate point of the lever are still equal. In the light of this analysis, as seen from the inertial system in motion, the force moment of the lever's two sides are not the same, so the lever will have no reason to maintain a balance.

It may be said that such an analysis is not consistent with reason. Due to the relativity of simultaneity, as seen from the inertial system in motion, the distance from A and B to the intermediate point of the lever are indeed not equal. A's mass is heavier, but the distance between A and the intermediate point of the lever is shorter, so the lever will still have reason to maintain a balance.

Given that this analysis is correct: as seen from the inertial system in motion, the distance from A and B to the intermediate point of the lever are indeed not equal; A's mass is heavier, but the distance between A and the intermediate point of the lever is shorter. Then, let us have a further analysis. When B reaches at the end of the lever's right side, A has not yet arrived at the end of the lever's left side. After B falls down from the right end of the lever, A still stays on the lever's left arm, so the lever will still lose the balance.

It may be said that this analysis does not conform to reason either. The so-called relativity of simultaneity is only a visual effect. In fact, A and B are arriving at the two ends of the lever at the same time. Well, if A and B are arriving at the two ends of the lever at the same time, but A's mass and B's mass are not equal as seen from the inertial system in motion, what reasons does the lever have to maintain a balance?

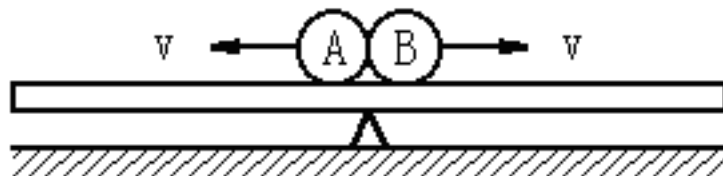

Fig.1

(4) **Elevator antinomy** As shown in Fig.2, a fixed pulley stays in place. Two identical elevators are fastened to two ends of the steel rope respectively, and there are two identical observers in the two elevators respectively. One elevator can be lifted by pulling down the other elevator.

Now, the left elevator uniformly rises and the right elevator uniformly falls. According to Special Relativity, an observer at rest on the ground will find that the mass of the two elevators will increase to the same value. The two elevators have the same weight, so they can maintain a uniform rise or fall.

However, as seen from the observer in the left elevator, he and the elevator that he stays in are at rest, the right elevator and the observer in it are in motion, so the mass of the right elevator is heavier.

As seen from the observer in the left elevator, the mass on the left side and right side are not equal. Why can the two elevators still remain a uniform rise or fall?

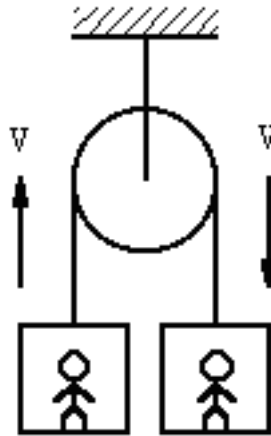

Fig.2

Some say that the lever and elevator antinomies are related to the gravitational field and are beyond the scope of the application of Special Relativity, so they only can be discussed and analyzed with General Relativity. Well, in the light of the equivalence principle of General Relativity, the gravitational field can be equivalent to a rocket in uniform accelerated motion. We can put the lever and elevator into the rocket, then in the perspective of observers outside the rocket in uniform horizontal or vertical motion, see whether the lever can maintain a balance, and the elevators can maintain a uniform rise or fall.

For the lever problem, as seen from an observer outside the rocket in an inertial system moving from left to right in a uniform rectilinear motion with the velocity

v , B's horizontal speed is 0 and A's horizontal speed is larger than v , so A's mass is heavier than B's. A, B move up with the same acceleration a , so the outside forces acted upon them are not equal, and the reaction forces that they act upon the lever are not equal either. Then, what reasons does the lever have to maintain a balance?

For the elevator problem, as seen from an observer outside the rocket in an inertial system moving from down to up in a uniform rectilinear motion, the left elevator's velocity is less than the right elevator's velocity, so the left elevator's mass is less than the right elevator's mass. The left and right elevators move up with the same acceleration a , so the outside forces acted upon them are not equal, and the reaction forces that then act upon the steel rope are not equal either. Then, why can the two elevators still maintain a relative uniform rise or fall?

4. The astronomical phenomena contradicting Special Relativity

Although there is no direct experimental evidence proving that observers are in motion with respect to matter particles, and whether the mass-velocity relation $M = mc/\sqrt{c^2 - v^2}$ is still valid, the energy of ultrahigh energy cosmic rays can often break GZK limit, which makes more and more people in the physical community come to recognize that the interpretation of the mass-velocity relation by Special Relativity may be wrong.

In the composition of cosmic rays, 90% are protons. And the cosmic microwave background radiation field is full of microwave photons. When the ultrahigh energy cosmic ray protons pass through the cosmic microwave background radiation field, according to Special Relativity, as seen from the protons, the wavelengths of the low-energy microwave photons in the cosmic microwave background radiation field will shorten, and they will become γ -rays. This effect has been described as a relativistic blue shift of photons. The process of proton's collisions with gamma rays in this situation has no difference with the experiments using gamma rays to impact protons in the laboratory. The results of this collision in the laboratory are the jet of many elementary particles including neutrinos and pions. The collisions between ultra-high energy cosmic rays and microwave photons should also have the same jet of neutrinos and pions, and the collisions would make the protons in ultra-high energy cosmic rays lose about 20% of the original energy. Six or seven times of the collisions would strip away most of their energy.

In 1966, Greisen, Zatsepin and Kuzmin put forward the famous GZK cutoff, that is, the proton over 150 million light years away with the energy more than $5 \times 10^{19} eV$ can not reach to the earth by the loss of energy caused by its collision

with the cosmic microwave background photons to produce pions. However, the first particle with the energy more than $10^{20}eV$ was found in the 1960s, and there have been also many new reports of these particles in the subsequent 40 years. There are hundreds of events finding the particles with the energy of $4 \times 10^{19}eV - 10^{20}eV$, and more than 20 events finding the particles with the energy over $10^{20}eV$. Most experimental stations reported these particles are isotropic.

Not only in the Galaxy, but also within a distance of 150 million light years, the scientists have not found the emission sources of ultra-high energy cosmic rays. So most physicists believe that ultra-high energy cosmic rays come from outside the Galaxy. However, how do they maintain the ultra-high energy while passing through the huge cosmic microwave background radiation field?

5. Where does the problem of Special Relativity lie?

Why does the *Special Relativity* bring so many paradoxes? Where does the problem lie?

Special Relativity is established on the two fundamental postulates: constant speed of light and the principle of relativity. It is stated that the principle of relativity affirms that the laws of physics are the same in all inertial systems, including the constant speed of light. So in fact Special Relativity has only one postulate - the principle of relativity.

For the principle of relativity, it has been already written into the junior school physics textbook as a basic principle of physics. The textbook tells of an experiment made by Galileo over 400 years ago. He used a large vessel to make this experiment, and found that the observers in the sealed cabin couldn't be aware of whether the vessel was in motion with respect to the bank. The experimental results in the sealed cabin and on the bank were the same, so Galileo concluded that the laws of physics are the same in all inertial systems.

The same observation results and laws of physics in different inertial systems are required in Special Relativity. This is the requirement of its postulate - the principle of relativity. However, we found that in accordance with the principle of relativity, the analysis of the same physical phenomena in different inertial systems can lead to conflicting results. To resolve these conflicts, physicists have come up with various kinds of ideas. But often when they just solve one problem, another problem appears. The old conflicts are hidden, but the new contradictions are exposed.

However, where does the problem lie?

Few doubts whether the principle of relativity is correct, especially in the high-speed motion. Galileo's experiment can only tell you that in the slow motion the principle of relativity is approximately correct.

Can anyone conduct such an experiment, for example, an object is at rest with earth and an observer is in accelerated motion, then he finds that the object's mass increases? An electric charge is at rest with earth and an observer is in accelerated motion, then he finds that the electric charge produces the magnetic field? I have read some books like *Special Relativity and its Experimental Foundations* and find that no one has made such experiments.

If no one has done such experiments, then the principle of relativity is only a theory taken for granted! The theories based on this principle, such as many theories about the relativistic electric dynamics, are not confirmed by experiments, so their accuracies are doubtful.

6. Using neutrosophy to remould the special theory of relativity

In order to solve the various problems existing in the special theory of relativity, the author proposes a new theory of *five-dimensional space-time and motion dynamics*. This theory does not need and recognize the principle of relativity, so various paradoxes brought by the special theory of relativity will no longer exist. However, it can also explain the phenomena such as the increase of mass and slow down of time for objects in motion, and $E = mc^2$, which the special theory of relativity can explain. Moreover, its derivation is much simpler.

In 1905, Albert Einstein published the special theory of relativity, which first linked time and space together. In 1907, Minkowski further proposed his four-dimensional space theory, which considered time is also one of the four dimensions. With human's in-depth understanding and research to the nature, the deep-rooted ties between time and space must also be further recognized by the world.

Here, I would like to express some of my views on time and space.

We have seen time as one dimension of the four: time is like a long river that constantly flows around us. Or it can be said that we are in constant motion with respect to the long river of time. One's life journey can be compared to one section of the long river of time, and starts from the beginning of this section and ends to the end of this section. If someone can slow down the speed of the motion from the beginning to the end, then his life will be a little longer. How do we measure

and compare the velocities of the motions in this dimension of time? So we need to establish an independent absolute time to measure and compare the velocities of the motions in the four-dimensional space. This independent absolute time beyond the four-dimensional space is uniform and flowing constantly. Adding the absolute time into the four-dimensional space-time leads to a five-dimensional space-time.

We have already known that light is a particle with wave nature. But does a matter particle also have wave nature? De Broglie boldly proposed his hypothesis that considered a matter particle should also have wave nature. Later, the experiments proved this hypothesis. We also know that the photon has a constant speed c in the three-dimensional space. Then, can we also assume that a matter particle and a photon have no difference in nature, and they both have a constant speed c in the four-dimensional space? That is,

$$\sqrt{v_x^2 + v_y^2 + v_z^2 + v_t^2} = c. \quad (1)$$

Among them, v_x, v_y, v_z are the velocities in the three dimensions respectively and v_t is the velocity in the dimension of time, or

$$\sqrt{v^2 + v_t^2} = c \quad (2)$$

where v is the velocity in the three dimensions, $v = \sqrt{v_x^2 + v_y^2 + v_z^2}$. For a photon, its velocity in the three dimensions is $v = c$, so its velocity in the dimension of time is $v_t = 0$.

For a matter particle at rest in the three dimensions, its velocity in the three dimensions is $v = 0$, so its velocity in the dimension of time is $v_t = c$.

For a matter particle moving in the three dimensions, its velocity in the three dimensions

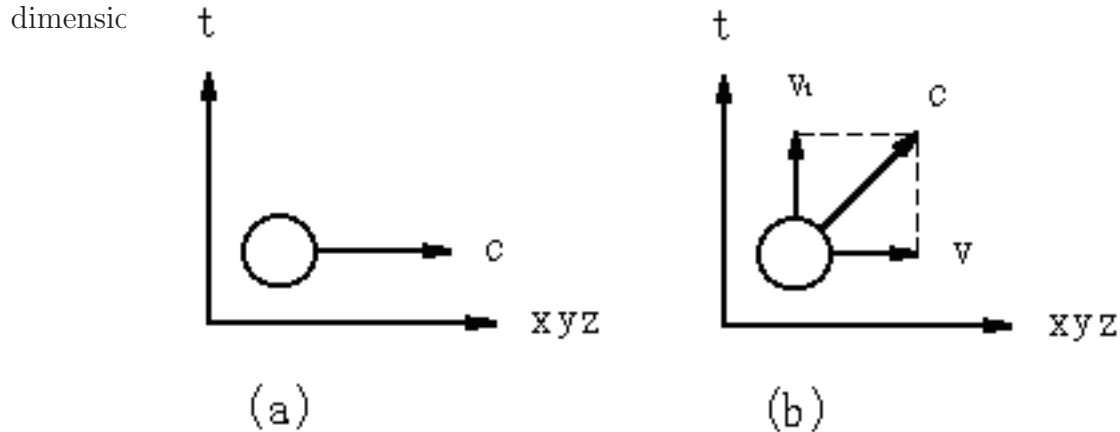

Fig.3

Fig.3 shows that a photon and a matter particle move in the four-dimensional space. Given that a matter particle has also a momentum when it moves in the dimension of time, and the law of conservation of momentum can also be applied in the four-dimensional space, then we can simply deduce the phenomena that when the matter particle is acted upon a external force to move, its mass will increase and time will slow down.

Someone might say that the three-dimensional space-time and the four-dimensional space-time are enough, the five-dimensional space-time is purely superfluous. If we propose a hypothesis difficult to be confirmed only for explaining a phenomenon, the five-dimensional space-time is indeed superfluous. However, the five-dimensional space-time is not created out of thin air, it is deduced on the analogy of the matter particles and photons.

(1) The interpretation on the phenomenon of the increase of mass

We first analyze a problem: as shown in figure 4a, a matter particle at rest in the three-dimensional space with a rest mass m starts to move after a horizontal rightward force F is acted upon it, as shown in figure 4a, then it reaches a horizontal rightward velocity v and its mass becomes M . We have already known $M = mc/\sqrt{c^2 - v^2}$, but why is there such a relation?



Fig.4

Then, we analyze another problem: as shown in figure 5a, a photon in the vertical upward motion with a motion mass m is acted upon a horizontal rightward force F , then it reaches a horizontal rightward velocity v , as shown in figure 5b. What is its mass M now? Because the speed of light is constant, equal to c , so the velocity of the photon in the vertical upward direction is $\sqrt{c^2 - v^2}$. Since the photon has not been acted upon a force in the vertical direction, there is a momentum conservation in the vertical direction. Then we can conclude $mc = M\sqrt{c^2 - v^2}$, so $M = mc/\sqrt{c^2 - v^2}$.

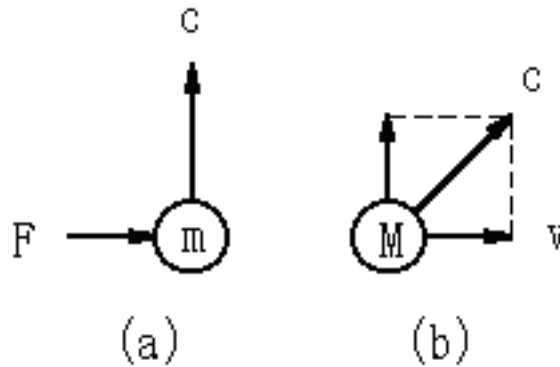

Fig.5

Comparing with the two problems, we can find that when a matter particle with a rest mass m and a photon with a motion mass m are acted upon the same horizontal rightward force F , they reach to the same horizontal rightward velocity v , and their increase of mass are exactly the same. This would enable us to speculate: can a matter particle at rest with a rest mass m move with a velocity c in a dimension outside the xyz three-dimensional space – the fourth dimension, and its velocity in the four-dimensional space composed by xyz dimensions and the fourth dimension is constant, equal to c ?

If this is the case, we can easily explain why when a matter particle at rest with a rest mass m in the three-dimensional space starts to move after a force F is acted upon it, its mass will increase to $M = mc/\sqrt{c^2 - v^2}$.

If the fourth dimension is existed, then what is it? Thinking of that time keeps passing around us and we are moving constantly in the long river of time. We must have a guess: the fourth dimension is time!

(2) The interpretation on the phenomenon of slow down of time

We first analyze a problem: as shown in figure 6a, the distance between the light source and the blackbody is L , and the photons produced by the light source will be absorbed by the blackbody when they reach to it. The lifetime of a photon is $t=L/c$.

Now we make the light source rotate a certain angle, as shown in figure 6b. The velocity of the photon in horizontal direction is v , and the velocity of the photon in vertical upward direction will decrease from c to $\sqrt{c^2 - v^2}$. The photons produced by the light source will be absorbed by the blackbody when they reach to it, and now the photons' lifetimes are $T=L/\sqrt{c^2 - v^2}$.

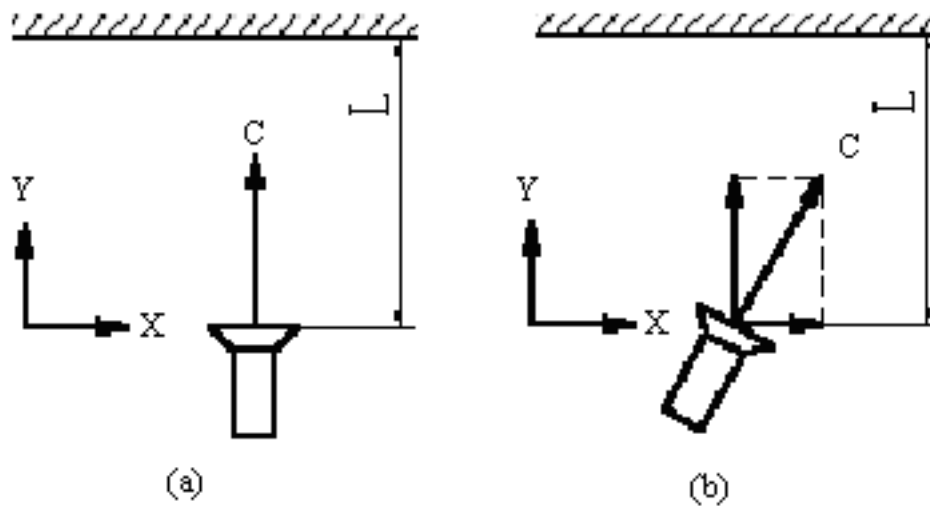

Fig.6

Comparing with them, we find that the latter photon's lifetime is extended, $T = tc/\sqrt{c^2 - v^2}$.

Then, we analyze the decay of a matter particle. The lifetime of the matter particle at rest in the three-dimensional space is t from its birth to its decay. If using the four-dimensional space to analyze it, its velocity is c in the fourth dimension – time.

Now a matter particle has a velocity v once it is born, then its velocity in the fourth dimension – time will be reduced to $\sqrt{c^2 - v^2}$. Here, the lifetime of the matter particle is T .

Comparing with them, we find that the latter matter particle has a smaller velocity in the fourth dimension – time, so it should have a slower decay, longer decay period and extended lifetime, $T = tc/\sqrt{c^2 - v^2}$.

(3) Explanation of length contraction

Lorentz contraction has not been proved by experiments. Whether it is a real presence or a visual effect has long been a subject of dispute, and has brought a variety of paradoxes, which haunt in the world of physics for decades.

In my opinion, Lorentz contraction is not a real presence, but a misunderstanding caused by the slow down of time for observers moving with respect to the three-dimensional space. Observers at rest in the three-dimensional space cannot observe this contraction. My analysis and reasons are as follows:

A 1-meter long ruler is in a horizontal motion from left to right with respect

to the three-dimensional space. When its right end arrives at an observer at rest in the three-dimensional space, the observer starts to record time. When its left end arrives at the observer at rest, the observer stops to record time. When the velocity of the ruler multiplies this time interval, the result is the length of the ruler. In this time interval, N matter particles have been decayed in the rest reference frame.

There is another observer in the same motion with the ruler with respect to the three-dimensional space. In his view, the length of the ruler equals to the result when the time interval observed by him multiplies his velocity with respect to the rest reference frame. His velocity equals to the ruler's velocity observed in the rest reference frame.

Due to the slower time in the rest reference frame with respect to the motion reference frame, if N matter particles are decayed in the time interval observed in the rest reference frame, only $N \times \sqrt{c^2 - v^2}/c$ matter particles are decayed in the time interval observed in the motion reference frame.

The decay process of each matter particle is a clock. The observer in the motion reference frame will find that the number of the decaying particles that he has observed is less than those observed by the observer in the rest reference frame, so he will misunderstand that the length of the ruler that he observes has been contracted.

(4) Explanation of the mass-energy formula

Let us have a look at how the well-known mass-energy formula is derived. For a matter particle with a rest mass m , if it is completely transformed into energy E (for example, the annihilation of a positron and an electron into two photons), that is, transformed into a photon with a motion mass m , then how much energy is contained in E ? Or what is the biggest work W that the photon acts upon the outside? We have affirmed the constant speed of light. If the photon constantly does work upon the environment when an external force is acted upon it, its motion mass will decrease until eventually it is 0. In this time interval t , the distance of its motion is s . Then, we can conclude $E = W = Fs = Fct$, and according to the law of momentum, the momentum of the photon is $mc = Ft$, finally we conclude $E = W = Fct = mcs = mc^2$.

This shows that $E = mc^2$ is just the photon's motion energy.

(5) As for the Lorentz transformation of velocity, because we have affirmed the constant speed of light, the methods, steps and results for its derivation are fully

consistent with the special theory of relativity.

7. Theoretical explanation

The conclusions derived according to the above assumptions and the special theory of relativity are not exactly the same. In the special theory of relativity, the increase of mass and the slow down of time are both relative, observers in different inertial systems will find some different results, which are related with the velocity of the observers. However, the increase of mass and the slow down of time derived according to the above assumptions are absolute with respect to the three-dimensional space, and they don't vary when the observers are in different inertial systems. Or we can say that the special theory of relativity is wrong, and there is an absolutely rest reference frame. Based on these assumptions and derivations, all the paradoxes brought by the special theory of relativity will no longer exist.

However, where is the absolutely rest reference frame? The author believes that it is not Aether, but the center where the explosion of the universe occurs.

Before the current universe came into being, all the substances in the universe were concentrated together and at rest in the three-dimensional space, and meanwhile moved with a velocity c in the fourth dimension – time.

After the big bang of the universe, substances moved in all directions in the three-dimensional space, which constitute today's universe.

Earth also constantly moves in the universe, but its velocity in the three-dimensional space is negligible with respect to the high-speed objects that near to the velocity of light. So for the observers in Earth, the increase of mass and the slow down of time are approximately true. Perhaps one day, experimental physicists can precisely measure the small errors between the actual values and the values calculated by the formulas of the increase of mass and the slow down of time, then the absolute velocity of Earth with respect to the absolutely rest reference frame in the universe can be measured.

For the phenomena about the increase of mass, according to the above theory, an object's mass increases only when an external work has done upon it or it absorbs energy from the environment, and doesn't vary with the change of the observer's relative velocity. The change of energy decides whether or not the mass increases, and it has nothing to do with the observer's relative velocity. The real reason for the increase of the moving object's mass is that the object has absorbed energy from other objects outside. Like the charge, mass is the inherent attribute of an object, so it has nothing to do with the observer's relative velocity. If the object has

not obtained energy from other objects outside and only the observer moves with respect to the object, the observer should have no reason to see that the object's mass increases. This kind of understanding is consistent with Newtonian mechanics.

For the phenomenon that a positron and an electron absorb each other, and accelerate to collide, resulting in the annihilation into two photons, if we use the special theory of relativity to analyze, the positron and electron's masses will become bigger and bigger and finally annihilate into two photons, whose motion masses will be bigger than the rest masses of the positron and electron. However, this is not true.

For another phenomenon that electrons and protons absorb each other, and accelerate to collide, resulting in the forming of an atom and the release of photons, if we use the special theory of relativity to analyze, the electrons and protons in an atom rotate around its center of mass, so all their masses should increase. However, where do the increasing masses come from?

If using my theory to explain, it is very easy. When a positron and an electron absorb each other and accelerate to collide, they do work on each other and absorb each other's energy. One side's absorbed energy from the other side equals to the energy absorbed by the other side from it, so their masses remain unchanged, and each photon's motion mass still equals to the rest mass of a positron or an electron after the annihilation into two photons.

For the forming process of an atom from protons and electrons, an electron's mass is far less than a proton's mass, so the work done by the electron on the proton is far less than the work done by the proton on the electron when they are acted upon by the same absorption force. Therefore, the energy that the electron absorbs from the proton is far more than the energy that the electron gives to the proton, so the electron's mass increases and the proton's mass decreases. But according to the special theory of relativity, the proton starts to move from the state of at-rest, so its mass also increases.

For the phenomena that the ultrahigh energy cosmic rays can often break GZK limit, it is easy to explain. Because mass has nothing to do with the observer's relative velocity, from the perspective of the ultrahigh energy cosmic ray protons, the proton's mass will not reduce to the rest mass, and the low-motion mass microwave photons in the cosmic microwave background radiation field will not translate into high-motion mass gamma rays. Therefore, there is almost no loss of energy when a proton collides with a microwave photon, so it can maintain an ultrahigh energy after passing through the huge cosmic microwave background radiation field.

8. The necessity of the existence of an absolute rest reference frame

Here, the author would like to put forward a new question:

A, B objects are relatively at rest in the beginning, and then A moves after an external work (such as photon impact or electric-field force) acts upon it, and its velocity increases from 0 to v . In the view of B, A's mass will increase. It is easy to explain, because A has obtained the energy from the outside.

Now A has a second interaction with the outside, and its velocity decreases from v to 0, returning to the resting state. Then, does A's mass increase or decrease at this time?

Some believe that when the second external work is done upon A, as seen from the motion reference frame with a velocity v , A's velocity increases from 0 to v . A obtains a second work done upon it by the outside, that is, obtains a second energy from the outside, so A's mass should increase again. This result is consistent with those as seen from B.

For this, the author has a question: If A is an electron or a proton, A has experienced a deceleration motion and an acceleration motion, and finally returns to the resting state. If A's mass does not return to the rest mass of an electron or a proton, but increases, then won't A become a new particle? Why do we have not yet found such a new particle? Moreover, as seen from B, A's second interaction with the outside is a process doing work upon the outside, so it should release energy and mass, which is not consistent with the those as seen from the motion reference frame with a velocity v . For an object's interaction with the outside, we still cannot confirm whether the outside does work on it and it absorbs energy from the outside or it does work on the outside and it releases energy and mass to the outside. Therefore, the paradoxes caused by the increase of mass for objects in motion still cannot be solved.

Therefore, the author believes that there must be an absolute rest reference frame. For an object's interaction with the outside, if it's velocity increases with respect to the absolute rest reference frame, the outside does work on it, and it absorbs energy and mass from the outside, resulting in the increase of its mass. Rather the contrary.

In his paper *Einstein and Relativity Theory*, Guo Hanying said: In relativity theory, the relationships among some basic principles are not fully coordinated.

Professor Tan Shusheng said in his paper *Where to find Aether, Where no Aether – The New Study of Special Relativity* that In recent years, the study con-

firmed that only in one inertial system the background radiation is strictly isotropic. In any other motion inertial reference frame, the radiation temperature is changed with the change of the directions. It can be said that the cosmic background radiation is the best matter reflection of the cosmic standard coordinate. By measuring the small temperature deviations of the cosmic background radiation reaching Earth from all directions, we can gain the absolute velocity of Earth while passing through the *cosmic background*, which is about 400 km / s.

Microwave background radiation is considered to be the remnants of the big bang of the universe. In my view, perhaps the cosmic microwave background radiation field is just the absolute rest reference frame. The velocity v in the formulas about the increase of an object's mass and the slow down of time should be the object's velocity v with respect to the cosmic microwave background radiation field.

9. Conclusions

Five-dimensional space-time and mechanics theory is the inheritance, development and perfection based on the special theory of relativity, and the integration of Minkowski space theory and Newton's absolute space-time. It is summed up by the author for many years, and is a bit of attempt at the development and improvement of the special theory of relativity. I don't believe that I have discovered the truth, but a bit of attempt to further explore the truth. Truth needs more people with knowledge and lofty ideals to explore and study. I just throw out a brick to attract a jade, and sincerely hope the men of insight can express their own views, and give me a correction.

A Geometrical Model on Cosmos

Guan Yiyong, Guan Tianyu, Chen Shuan and Zhang Yan

(Diantan Road No.71, Xiangfang District, Harbin 150030, P.R. China)

E-mail: guanyiyong@163.com

Abstract: This paper proposes a new model of matter based on a large number of observations. It is shown that the positive matter and negative matter are different existing forms of the same matter. The relationship between the black hole and the white hole is revealed. It is shown that there are black holes of various levels everywhere. The matter in positive and negative states, the black hole and white hole, and black holes of various levels may all be put in proper places in a Smarandache multi-space.

Key words: Relativity, positive and negative matter, cosmological model, Smarandache multi-spaces

1 Introduction

It is well-known that the Dirac Equation may have solutions with negative energy. Some scholars used to suggest that the negative energy solutions should be discarded. But later on, two basic reasons were discovered against the abandonment of the negative energy state. The first reason is based on the theoretical physics. Dirac Equation shows that a system in positive energy state may turn into negative energy state under the inductive transition. So, we may come up with contradictions should we discard the negative energy state. The second reason is based on mathematics, i.e. the abandonment of the negative energy state will result in an imperfect set of wave functions, and therefore, an arbitrary function will not be able to be expanded into an imperfect set of functions[1].

2. A geometrical model on cosmos

As mentioned above a super-dimensional time-space model can be established which we call it *G cosmological model*, as those shown in Fig.1. The virtual space is

composed of the AB-O-DC region (the double-cone or the double bell in the sphere), of a Lobachevsky geometry, which is a high-energy region with the energy and curvature of space of negative value. The real space is composed of the AB-FE-DC region, of a Riemann Geometry, which is a low-energy region with the energy and curvature of space of positive value. There are no universal relations among things in the virtual space, and the law of causality does not hold true there. In the mathematical language, we may say that through a point outside a line, there are innumerable lines which will not intersect with that line in the Lobachevsky space. On the other hand, through a point outside a line, all lines will intersect with the line in the Riemann space. AB and DC form the vision interface ring.

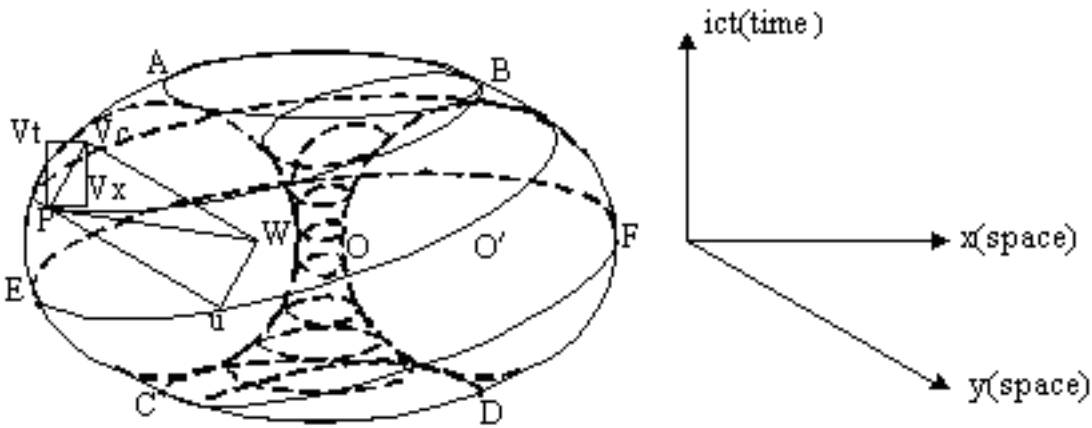

Fig.1

Now, consider an electron moving up in rotation along the outer surface of the sphere, when it reaches AB through EF from CD, the electron enters the virtual space from the real space, and both the time and the parity are reversed. When the electron moves down in rotation in backward direction of time along the double-bell region on the inner surface and reaches CD through o, it enters the real space with positive energy from the virtual space again, and the time and the parity are reversed once again. According to R.P. Feynman, an electron moving in backward direction of time along the inner side of the double-bell region with negative energy is equivalent to a positive electron moving in forward direction of time with the positive energy along the inner side of the double-bell region. Therefore, the above process can be viewed as a pair of electron-positron is being produced in DC and disappears after moving forward along time to AB. In other words, when a particle moves from CD to AB through EF, it has negative charge; when the particle moves from AB to CD through O in backward direction of time, it will have positive charge.

Viewed from outside, DC ring represents the white hole, and AB the black hole. The black hole and white hole are interconnected through the O section.

The Smarandache multi-spaces is a useful tool for dealing with matter in positive and negative states at a same time. The conception of Smarandache multi-spaces were brought forward by Smarandache in 1969. n aggregates or subspaces M_1, M_2, \dots, M_n to form a Smarandache multi-space

$$M = M_1 \cup M_2 \cup \dots \cup M_n$$

with $n, n \geq 1$ being an integer.

3. Applications of the G cosmological model

(1)The origin of cosmos

The cosmos has quantum in its initial period, which is carried by the so-called *Taiji pattern* in ancient China as the smallest unit carrying quantum. The total number of *Taiji pattern* is invariant in the G cosmological model. According to the *Book of Changing* in ancient China, *Taiji* generates two pattern, called *Liang Yis*, i.e., the positive matter and negative matter. The positive matter (real) and negative matter (virtual) are not essentially different except in different forms of quantum carried by different *Taiji* pattern. *Liang Yis* generate *Four Patterns*, called *Si Xiang*. Then everything is generated by these *Si Xiang*. Time and space then come into being.

(2)The cosmos has its limit but with no boundaries

It is known that matter enters the virtual cosmos if its velocity of movement exceeds the speed of light and then matter will change its sign and become antimatter. The anti-cosmos is composed of antimatter. The interface between the real cosmos and the virtual cosmos is determined by the speed of light. Therefore, we can say that the basic difference between the real cosmos and the virtual cosmos is in their different states of movement.

The matter that moves at the speed of light on the interface ring makes up the interface between the visual cosmos and the real cosmos. The matter moves in the virtual space at an ultra-light speed. The observers inside the interface will think that their cosmos is infinite. Based on the formula of relativity, the ruler measuring cosmos by the observer will gradually be shortened when the observer is gradually near cosmos's interface because the velocity of ruler's movement gradually is increased towards the speed of light. Therefore, in the observer's measurement

with his own ruler, the distance to the interface is infinite, and he will never reach the interface of the cosmos.

From Haber’s law, it is known that the matter in the deep cosmos far from us moves in a velocity near the speed of light. The interaction between the positive matter and the negative matter is violent near the boundary of the cosmos. The interaction produces a lot of high-energy gamma-photons, which evenly spread in the entire space. That is the origin of the matter pulsation in the deep cosmos and the diffusion of the gamma-ray.

(3) The pulsating cosmos

According to the theory of complex number time-space, we derivative formula following.

$$\hat{v} = v_x + iv_t = |c| (-\sin \theta + i \cos \theta),$$

$$\hat{a} = a_x + a_t = -\frac{c^2}{|r_c|}(\cos \theta + i \sin \theta),$$

..... ,

$$\frac{d^n r}{dt^n} = \omega^n |r| [i^n \cos(\omega t + \theta_0) + i^{n+1} \sin(\omega t + \theta_0)],$$

where θ is a time-space angle of materialistic movement and c the speed of light.

We can obtain an angle-speed formula also.

$$\sin \theta = -\frac{v_x}{c}, \quad \cos \theta = \sqrt{1 - \sin^2 \theta} = \sqrt{1 - \frac{v_x^2}{c^2}}$$

and a force-speed formula

$$F = F_x + iF_t = m\hat{a} = m(a_x + ia_t) = -\frac{mc^2}{|r_c|}(\cos \theta + i \sin \theta)$$

$$F_x = -m\frac{c^2}{|r_c|} \cos \theta = -\frac{mc^2}{|r_c|} \sqrt{1 - \frac{v_x^2}{c^2}}.$$

Where, if $v = 0$ then $F_x = -\frac{mc^2}{|r_c|}$ and if $v = c$, $F_x = 0$.

Now if we cut the G model along the central line, viewing the cross section from one side (Fig.2), the process that a particle moves along O-D-F-B is similar to a circular motion in the space-time. If the trajectory is projected on the axis of space (such as in Fig.2), the movement turns out to be a simple periodic pulsation.

If we define the direction from the outer sphere surface to the inside of G model as positive, from the projection of the particle's trajectory on the axis of space, it is seen that the force will be positive and mainly attractive at the stage of D-F-B. The force will be negative and mainly repulsive at the stage of B-O-D. The projection of the particle's velocity of motion on the axis of space reaches maximum at points B and D, with opposite directions and zero acceleration. The matter moving on the vision ring has no intersection in space. As to the projection of the velocity of motion on the axis of the space at the points O and F, the accelerations take maximum absolute values with opposite signs, and with zero velocity.

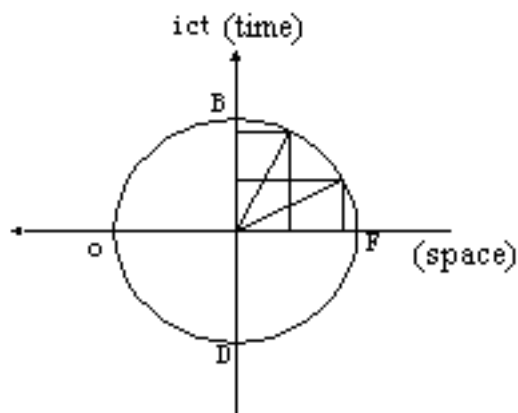

Fig.2

If the G model trajectory is projected to a plane in space (such as those shown in Fig.3), we can see that cosmos is expanding with speed exceeding the speed of light and accelerates in initial stages when the repulsive force is important, and the curvature of space is negative, and the cosmos has negative energy. After the cosmos has expanded to vision ring, it starts to expand with speed lower than the speed of light and decelerates, at that time the gravitation is important, and the curvature of space is positive, and the cosmos has positive energy. Due to the gravitation, when the cosmos expands to a certain extent, it starts to shrink with speed lower than the speed of light and accelerates, at that time, the curvature of space is positive, and the gravitation is important. When the cosmos shrinks to vision ring, it starts to shrink with speed exceeding the speed of light and decelerates, at that time the repulsive force is important, and the curvature of space is negative, and the cosmos has negative energy. The Cosmos just goes from one such cycle to another infinitely.

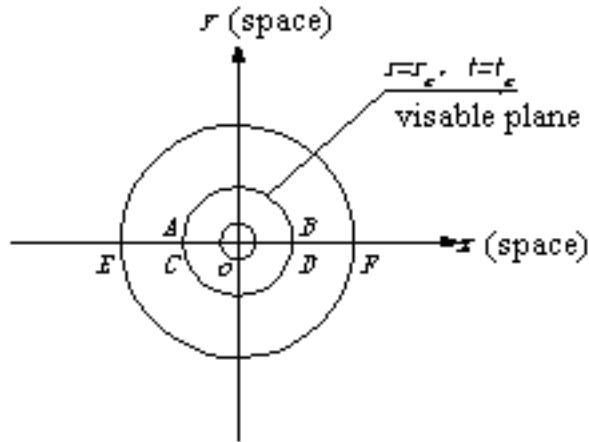

Fig.3

From the above discussion, it can be seen that when a particle moves at a constant velocity in the time-space, it will no longer move at the constant velocity if its trajectory is projected on the axis of space. Therefore, one may say that the force is the effect of projection of the moving trajectory in the time-space on the axis of space. The form of action of time has effect on space.

In fact, one may describe the differences of the positive matter and the negative matter in the G Model, from the point of view of time, in the following way: one is moving in the forward time, and the other is moving in the backward time; from the point of view of space, one is moving with larger-than-zero inherence acceleration, and the other is moving with less-than-zero inherence acceleration.

(4)The non-Euclidean cosmos

Since the matter that moves at the speed of light on the dividing ring makes up the plane of the interface between the virtual cosmos and the real cosmos, if we consider a circle with its center in the cosmos and a huge radius (extend the circle to points near the boundary of the cosmos), the circumference measured with very much shortened ruler divided by the radius measured with a ruler changing its length all the way along the radius will not equal to 2π . Thus it may be concluded that the cosmos with interface related with a velocity of the speed of light is not Euclidean and we call it non-Euclidean cosmos.

(5) The multi-layers cosmos

From the uncertainty principle, we obtain the force-distance formula (9)

$$F_x = -\frac{mc^2}{|r_c|} \sqrt{1 - k \frac{(\Delta r_c)^2}{(\Delta r)^2}}$$

and a force-time formula :

$$F_x = -\frac{mc^2}{|r_c|} \sqrt{1 - k \frac{\Delta t_c}{\Delta t}},$$

where r is the radius of the universe, t the universe time, r_c the radius of vision ring and t_c the period of time of vision ring.

If $\Delta r < \Delta r_c$ or $\Delta t < \Delta t_c$, or if $r_0 = 0$ and $t_0 = 0$, and $r < r_c$ or $t < t_c$, namely, when the space of materialistic motion is small enough or time of materialistic existence is short enough, or when the cosmos radius is less than radius of cosmos vision ring or the cosmos existing time is less than period of cosmos vision ring time, then the universal gravitation will change into universal repulsion, and at that time, the cosmos will become the anti-cosmos and time will flow backwards and matter will become anti-matter. That is the fundamental reason why we can not see the anti-matter in the macroscopic world. But we may say that there are anti-matter all the time and in all the space.

We will encounter a lot of complicated problems when we study positive and negative states of matter, and great universe and microcosmic universe, and black hole and white hole, and different levels of black hole age, etc. We can deal with different problems of different domain together with Smarandache multi-spaces. For example, we can separately construct positive and negative states of matter first, then we unify the two spaces with Smarandache multi-spaces. This way will make many problems very simple, and many problems that we can not solve in the past may be solved in some near days.

References

- [1] R.P.Feynman, *Lectures on Quantum Electrodynamics*, Science Press, Beijing, 1985.
- [2] James D. Bjorken and Sidney D. Drell, *Relativistic Quantum Mechanics*, Science Press, Beijing, ?-?
- [3] H. Alfvén, *Cosmic Plasma*, Science Press, Beijing, 1981.
- [4] F.Smarandache, Mixed noneuclidean geometries, *eprint arXiv: math/0010119*, 10/2000.
- [5] F.Smarandache, *A Unifying Field in Logics- Neutrosophy: Neutrosophic Probability, Set, and Logic*, American research Press, Rehoboth, 1999.

Combinatorially Differential Geometry

Linfan Mao

(Chinese Academy of Mathematics and System Science, Beijing 100080, P.R.China)

E-mail: maolinfan@163.com

Abstract: For an integer $m \geq 1$, a combinatorial manifold \widetilde{M} is defined to be a geometrical object \widetilde{M} such that for $\forall p \in \widetilde{M}$, there is a local chart (U_p, φ_p) enable $\varphi_p : U_p \rightarrow B^{n_{i_1}} \cup B^{n_{i_2}} \cup \dots \cup B^{n_{i_{s(p)}}}$ with $B^{n_{i_1}} \cap B^{n_{i_2}} \cap \dots \cap B^{n_{i_{s(p)}}} \neq \emptyset$, where $B^{n_{i_j}}$ is an n_{i_j} -ball for integers $1 \leq j \leq s(p) \leq m$. Topological and differential structures such as those of d -pathwise connected, homotopy classes, fundamental d -groups in topology and tangent vector fields, tensor fields, connections, *Minkowski* norms in differential geometry on these finitely combinatorial manifolds are introduced. Some classical results are generalized to finitely combinatorial manifolds. Euler-Poincare characteristic is discussed and geometrical inclusions in Smarandache geometries for various geometries are also presented by the geometrical theory on finitely combinatorial manifolds in this paper.

Key Words: manifold, finitely combinatorial manifold, topological structure, differential structure, combinatorially Riemannian geometry, combinatorially Finsler geometry, Euler-Poincare characteristic.

AMS(2000): 51M15, 53B15, 53B40, 57N16

§1. Introduction

As a model of spacetimes in physics, various geometries such as those of Euclid, Riemannian and Finsler geometries are established by mathematicians. Today, more and more evidences have shown that our spacetime is not homogenous. Thereby models established on classical geometries are only unilateral. Then *are there some kinds of overall geometries for spacetimes in physics?* The answer is YES. Those are just Smarandache geometries established in last century but attract more one's attention now. According to the summary in [4], they are formally defined following.

Definition 1.1([4], [17]) *A Smarandache geometry is a geometry which has at least one Smarandachely denied axiom(1969), i.e., an axiom behaves in at least two different ways within the same space, i.e., validated and invalidated, or only invalidated but in multiple distinct ways.*

A Smarandache n -manifold is a n -manifold that support a Smarandache geometry.

For verifying the existence of Smarandache geometries, Kuciuk and Antholy gave a popular and easily understanding example on an Euclid plane in [4]. In [3], Iseri firstly presented a systematic construction for Smarandache geometries by equilateral triangular disks on Euclid planes, which are really Smarandache 2-dimensional geometries (see also [5]). In references [6], [7] and [13], particularly in [7], a general constructing way for Smarandache 2-dimensional geometries on maps on surfaces, called *map geometries* was introduced, which generalized the construction of Iseri. For the case of dimensional number ≥ 3 , these *pseudo-manifold geometries* are proposed, which are approved to be Smarandache geometries and containing these Finsler and Kähler geometries as sub-geometries in [12].

In fact, by the Definition 1.1 a general but more natural way for constructing Smarandache geometries should be seeking for them on a union set of spaces with an axiom validated in one space but invalidated in another, or invalidated in a space in one way and another space in a different way. These unions are so called Smarandache multi-spaces. This is the motivation for this paper. Notice that in [8], these *multi-metric spaces* have been introduced, which enables us to constructing Smarandache geometries on multi-metric spaces, particularly, on multi-metric spaces with a same metric.

Definition 1.2 *A multi-metric space \tilde{A} is a union of spaces A_1, A_2, \dots, A_m for an integer $k \geq 2$ such that each A_i is a space with metric ρ_i for $\forall i, 1 \leq i \leq m$.*

Now for any integer n , these n -manifolds M^n are the main objects in modern geometry and mechanics, which are locally euclidean spaces \mathbf{R}^n satisfying the T_2 separation axiom in fact, i.e., for $\forall p, q \in M^n$, there are local charts (U_p, φ_p) and (U_q, φ_q) such that $U_p \cap U_q = \emptyset$ and $\varphi_p : U_p \rightarrow \mathbf{B}^n$, $\varphi_q : U_q \rightarrow \mathbf{B}^n$, where

$$B^n = \{(x_1, x_2, \dots, x_n) | x_1^2 + x_2^2 + \dots + x_n^2 < 1\}.$$

is an open ball.

These manifolds are locally euclidean spaces. In fact, they are also homogenous

spaces. But the world is not homogenous. Whence, a more important thing is considering these combinations of different dimensions, i.e., *combinatorial manifolds* defined following and finding their good behaviors for mathematical sciences besides just to research these manifolds. Two examples for these combinations of manifolds with different dimensions in \mathbf{R}^3 are shown in Fig.1.1, in where, (a) represents a combination of a 3-manifold, a torus and 1-manifold, and (b) a torus with 4 bouquets of 1-manifolds.

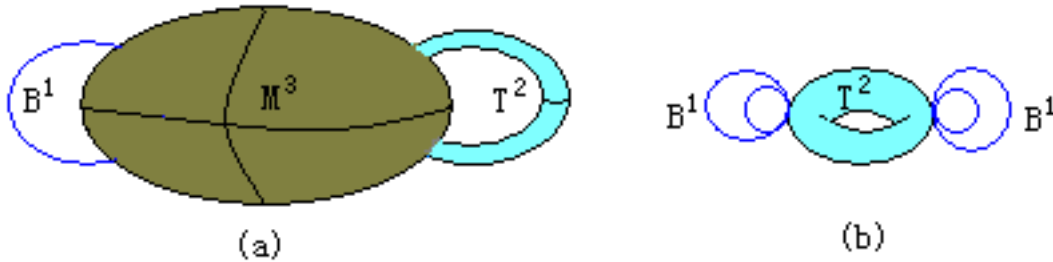

Fig.1.1

For an integer $s \geq 1$, let n_1, n_2, \dots, n_s be an integer sequence with $0 < n_1 < n_2 < \dots < n_s$. Choose s open unit balls $B_1^{n_1}, B_2^{n_2}, \dots, B_s^{n_s}$, where $\bigcap_{i=1}^s B_i^{n_i} \neq \emptyset$ in $\mathbf{R}^{n_1+n_2+\dots+n_s}$. Then a *unit open combinatorial ball of degree s* is a union

$$\tilde{B}(n_1, n_2, \dots, n_s) = \bigcup_{i=1}^s B_i^{n_i}.$$

Definition 1.3 For a given integer sequence $n_1, n_2, \dots, n_m, m \geq 1$ with $0 < n_1 < n_2 < \dots < n_s$, a *combinatorial manifold \tilde{M}* is a Hausdorff space such that for any point $p \in \tilde{M}$, there is a local chart (U_p, φ_p) of p , i.e., an open neighborhood U_p of p in \tilde{M} and a homoeomorphism $\varphi_p : U_p \rightarrow \tilde{B}(n_1(p), n_2(p), \dots, n_{s(p)}(p))$ with $\{n_1(p), n_2(p), \dots, n_{s(p)}(p)\} \subseteq \{n_1, n_2, \dots, n_m\}$ and $\bigcup_{p \in \tilde{M}} \{n_1(p), n_2(p), \dots, n_{s(p)}(p)\} = \{n_1, n_2, \dots, n_m\}$, denoted by $\tilde{M}(n_1, n_2, \dots, n_m)$ or \tilde{M} on the context and

$$\tilde{\mathcal{A}} = \{(U_p, \varphi_p) | p \in \tilde{M}(n_1, n_2, \dots, n_m)\}$$

an atlas on $\tilde{M}(n_1, n_2, \dots, n_m)$. The maximum value of $s(p)$ and the dimension $\tilde{s}(p)$ of $\bigcap_{i=1}^{s(p)} B_i^{n_i}$ are called the *dimension* and the *intersectional dimensional* of $\tilde{M}(n_1, n_2, \dots, n_m)$ at the point p , respectively.

A combinatorial manifold \tilde{M} is called *finite* if it is just combined by finite manifolds without one manifold contained in the union of others.

Notice that $\bigcap_{i=1}^s B_i^{n_i} \neq \emptyset$ by the definition of unit combinatorial balls of degree s . Thereby, for $\forall p \in \widetilde{M}(n_1, n_2, \dots, n_s)$, either it has a neighborhood U_p with $\varphi_p : U_p \rightarrow \mathbf{R}^s$, $\varsigma \in \{n_1, n_2, \dots, n_s\}$ or a combinatorial ball $\widetilde{B}(\tau_1, \tau_2, \dots, \tau_l)$ with $\varphi_p : U_p \rightarrow \widetilde{B}(\tau_1, \tau_2, \dots, \tau_l)$, $l \leq s$ and $\{\tau_1, \tau_2, \dots, \tau_l\} \subseteq \{n_1, n_2, \dots, n_s\}$ hold.

The main purpose of this paper is to characterize these finitely combinatorial manifolds, such as those of topological behaviors and differential structures on them by a combinatorial method. For these objectives, topological and differential structures such as those of d -pathwise connected, homotopy classes, fundamental d -groups in topology and tangent vector fields, tensor fields, connections, *Minkowski* norms in differential geometry on these combinatorial manifolds are introduced. Some results in classical differential geometry are generalized to finitely combinatorial manifolds. As an important invariant, Euler-Poincare characteristic is discussed and geometrical inclusions in Smarandache geometries for various existent geometries are also presented by the geometrical theory on finitely combinatorial manifolds in this paper.

For terminologies and notations not mentioned in this section, we follow [1]–[2] for differential geometry, [5], [7] for graphs and [14], [18] for topology.

§2. Topological structures on combinatorial manifolds

By a topological view, we introduce topological structures and characterize these finitely combinatorial manifolds in this section.

2.1. Pathwise connectedness

On the first, we define *d-dimensional pathwise connectedness* in a finitely combinatorial manifold for an integer $d, d \geq 1$, which is a natural generalization of *pathwise connectedness* in a topological space.

Definition 2.1 For two points p, q in a finitely combinatorial manifold $\widetilde{M}(n_1, n_2, \dots, n_m)$, if there is a sequence B_1, B_2, \dots, B_s of d -dimensional open balls with two conditions following hold.

- (1) $B_i \subset \widetilde{M}(n_1, n_2, \dots, n_m)$ for any integer $i, 1 \leq i \leq s$ and $p \in B_1, q \in B_s$;
- (2) The dimensional number $\dim(B_i \cap B_{i+1}) \geq d$ for $\forall i, 1 \leq i \leq s - 1$.

Then points p, q are called *d-dimensional connected* in $\widetilde{M}(n_1, n_2, \dots, n_m)$ and the sequence B_1, B_2, \dots, B_e a *d-dimensional path* connecting p and q , denoted by $P^d(p, q)$.

If each pair p, q of points in the finitely combinatorial manifold $\widetilde{M}(n_1, n_2, \dots, n_m)$

is d -dimensional connected, then $\widetilde{M}(n_1, n_2, \dots, n_m)$ is called d -pathwise connected and say its connectivity $\geq d$.

Not loss of generality, we consider only finitely combinatorial manifolds with a connectivity ≥ 1 in this paper. Let $\widetilde{M}(n_1, n_2, \dots, n_m)$ be a finitely combinatorial manifold and $d, d \geq 1$ an integer. We construct a labelled graph $G^d[\widetilde{M}(n_1, n_2, \dots, n_m)]$ by

$$V(G^d[\widetilde{M}(n_1, n_2, \dots, n_m)]) = V_1 \cup V_2,$$

where $V_1 = \{n_i - \text{manifolds } M^{n_i} \text{ in } \widetilde{M}(n_1, n_2, \dots, n_m) | 1 \leq i \leq m\}$ and $V_2 = \{\text{isolated intersection points } O_{M^{n_i}, M^{n_j}} \text{ of } M^{n_i}, M^{n_j} \text{ in } \widetilde{M}(n_1, n_2, \dots, n_m) \text{ for } 1 \leq i, j \leq m\}$. Label n_i for each n_i -manifold in V_1 and 0 for each vertex in V_2 and

$$E(G^d[\widetilde{M}(n_1, n_2, \dots, n_m)]) = E_1 \cup E_2,$$

where $E_1 = \{(M^{n_i}, M^{n_j}) | \dim(M^{n_i} \cap M^{n_j}) \geq d, 1 \leq i, j \leq m\}$ and $E_2 = \{(O_{M^{n_i}, M^{n_j}}, M^{n_i}), (O_{M^{n_i}, M^{n_j}}, M^{n_j}) | M^{n_i} \text{ tangent } M^{n_j} \text{ at the point } O_{M^{n_i}, M^{n_j}} \text{ for } 1 \leq i, j \leq m\}$.

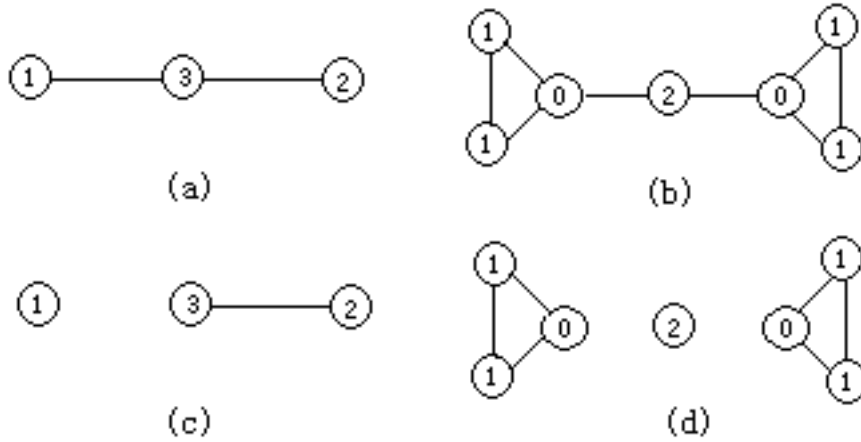

Fig.2.1

For example, these correspondent labelled graphs gotten from finitely combinatorial manifolds in Fig.1.1 are shown in Fig.2.1, in where $d = 1$ for (a) and (b), $d = 2$ for (c) and (d). By this construction, properties following can be easily gotten.

Theorem 2.1 *Let $G^d[\widetilde{M}(n_1, n_2, \dots, n_m)]$ be a labelled graph of a finitely combinatorial manifold $\widetilde{M}(n_1, n_2, \dots, n_m)$. Then*

- (1) $G^d[\widetilde{M}(n_1, n_2, \dots, n_m)]$ is connected only if $d \leq n_1$.

(2) there exists an integer $d, d \leq n_1$ such that $G^d[\widetilde{M}(n_1, n_2, \dots, n_m)]$ is connected.

Proof By definition, there is an edge (M^{n_i}, M^{n_j}) in $G^d[\widetilde{M}(n_1, n_2, \dots, n_m)]$ for $1 \leq i, j \leq m$ if and only if there is a d -dimensional path $P^d(p, q)$ connecting two points $p \in M^{n_i}$ and $q \in M^{n_j}$. Notice that

$$(P^d(p, q) \setminus M^{n_i}) \subseteq M^{n_j} \text{ and } (P^d(p, q) \setminus M^{n_j}) \subseteq M^{n_i}.$$

Whence,

$$d \leq \min\{n_i, n_j\}. \quad (2.1)$$

Now if $G^d[\widetilde{M}(n_1, n_2, \dots, n_m)]$ is connected, then there is a d -path $P(M^{n_i}, M^{n_j})$ connecting vertices M^{n_i} and M^{n_j} for $\forall M^{n_i}, M^{n_j} \in V(G^d[\widetilde{M}(n_1, n_2, \dots, n_m)])$. Not loss of generality, assume

$$P(M^{n_i}, M^{n_j}) = M^{n_i} M^{s_1} M^{s_2} \dots M^{s_{t-1}} M^{n_j}.$$

Then we get that

$$d \leq \min\{n_i, s_1, s_2, \dots, s_{t-1}, n_j\} \quad (2.2)$$

by (2.1). However, according to Definition 1.4 we know that

$$\bigcup_{p \in \widetilde{M}} \{n_1(p), n_2(p), \dots, n_{s(p)}(p)\} = \{n_1, n_2, \dots, n_m\}. \quad (2.3)$$

Therefore, we get that

$$d \leq \min\left(\bigcup_{p \in \widetilde{M}} \{n_1(p), n_2(p), \dots, n_{s(p)}(p)\}\right) = \min\{n_1, n_2, \dots, n_m\} = n_1$$

by combining (2.2) with (2.3). Notice that points labelled with 0 and 1 are always connected by a path. We get the conclusion (1).

For the conclusion (2), notice that any finitely combinatorial manifold is always pathwise 1-connected by definition. Accordingly, $G^1[\widetilde{M}(n_1, n_2, \dots, n_m)]$ is connected. Thereby, there at least one integer, for instance $d = 1$ enabling $G^d[\widetilde{M}(n_1, n_2, \dots, n_m)]$ to be connected. This completes the proof. \square

According to Theorem 2.1, we get immediately two corollaries following.

Corollary 2.1 For a given finitely combinatorial manifold \widetilde{M} , all connected graphs $G^d[\widetilde{M}]$ are isomorphic if $d \leq n_1$, denoted by $G[\widetilde{M}]$.

Corollary 2.2 If there are k 1-manifolds intersect at one point p in a finitely combinatorial manifold \widetilde{M} , then there is an induced subgraph K^{k+1} in $G[\widetilde{M}]$.

Now we define an edge set $E^d(\widetilde{M})$ in $G[\widetilde{M}]$ by

$$E^d(\widetilde{M}) = E(G^d[\widetilde{M}]) \setminus E(G^{d+1}[\widetilde{M}]).$$

Then we get a graphical recursion equation for graphs of a finitely combinatorial manifold \widetilde{M} as a by-product.

Theorem 2.2 Let \widetilde{M} be a finitely combinatorial manifold. Then for any integer $d, d \geq 1$, there is a recursion equation

$$G^{d+1}[\widetilde{M}] = G^d[\widetilde{M}] - E^d(\widetilde{M})$$

for graphs of \widetilde{M} .

Proof It can be obtained immediately by definition. \square

For a given integer sequence $1 \leq n_1 < n_2 < \cdots < n_m, m \geq 1$, denote by $\mathcal{H}^d(n_1, n_2, \cdots, n_m)$ all these finitely combinatorial manifolds $\widetilde{M}(n_1, n_2, \cdots, n_m)$ with connectivity $\geq d$, where $d \leq n_1$ and $\mathcal{G}(n_1, n_2, \cdots, n_m)$ all these connected graphs $G[n_1, n_2, \cdots, n_m]$ with vertex labels $0, n_1, n_2, \cdots, n_m$ and conditions following hold.

- (1) The induced subgraph by vertices labelled with 1 in G is a union of complete graphs;
- (2) All vertices labelled with 0 can only be adjacent to vertices labelled with 1.

Then we know a relation between sets $\mathcal{H}^d(n_1, n_2, \cdots, n_m)$ and $\mathcal{G}(n_1, n_2, \cdots, n_m)$.

Theorem 2.3 Let $1 \leq n_1 < n_2 < \cdots < n_m, m \geq 1$ be a given integer sequence. Then every finitely combinatorial manifold $\widetilde{M} \in \mathcal{H}^d(n_1, n_2, \cdots, n_m)$ defines a labelled connected graph $G[n_1, n_2, \cdots, n_m] \in \mathcal{G}(n_1, n_2, \cdots, n_m)$. Conversely, every labelled connected graph $G[n_1, n_2, \cdots, n_m] \in \mathcal{G}(n_1, n_2, \cdots, n_m)$ defines a finitely combinatorial manifold $\widetilde{M} \in \mathcal{H}^d(n_1, n_2, \cdots, n_m)$ for any integer $1 \leq d \leq n_1$.

Proof For $\forall \widetilde{M} \in \mathcal{H}^d(n_1, n_2, \cdots, n_m)$, there is a labelled graph $G[n_1, n_2, \cdots, n_m] \in \mathcal{G}(n_1, n_2, \cdots, n_m)$ correspondent to \widetilde{M} is already verified by Theorem 2.1. For

completing the proof, we only need to construct a finitely combinatorial manifold $\widetilde{M} \in \mathcal{H}^d(n_1, n_2, \dots, n_m)$ for $\forall G[n_1, n_2, \dots, n_m] \in \mathcal{G}(n_1, n_2, \dots, n_m)$. Denoted by $l(u) = s$ if the label of a vertex $u \in V(G[n_1, n_2, \dots, n_m])$ is s . The construction is carried out by the following programming.

STEP 1. Choose $|G[n_1, n_2, \dots, n_m]| - |V_0|$ manifolds correspondent to each vertex u with a dimensional n_i if $l(u) = n_i$, where $V_0 = \{u | u \in V(G[n_1, n_2, \dots, n_m]) \text{ and } l(u) = 0\}$. Denoted by $V_{\geq 1}$ all these vertices in $G[n_1, n_2, \dots, n_m]$ with label ≥ 1 .

STEP 2. For $\forall u_1 \in V_{\geq 1}$ with $l(u_1) = n_{i_1}$, if its neighborhood set $N_{G[n_1, n_2, \dots, n_m]}(u_1) \cap V_{\geq 1} = \{v_1^1, v_1^2, \dots, v_1^{s(u_1)}\}$ with $l(v_1^1) = n_{11}, l(v_1^2) = n_{12}, \dots, l(v_1^{s(u_1)}) = n_{1s(u_1)}$, then let the manifold correspondent to the vertex u_1 with an intersection dimension $\geq d$ with manifolds correspondent to vertices $v_1^1, v_1^2, \dots, v_1^{s(u_1)}$ and define a vertex set $\Delta_1 = \{u_1\}$.

STEP 3. If the vertex set $\Delta_l = \{u_1, u_2, \dots, u_l\} \subseteq V_{\geq 1}$ has been defined and $V_{\geq 1} \setminus \Delta_l \neq \emptyset$, let $u_{l+1} \in V_{\geq 1} \setminus \Delta_l$ with a label $n_{i_{l+1}}$. Assume

$$(N_{G[n_1, n_2, \dots, n_m]}(u_{l+1}) \cap V_{\geq 1}) \setminus \Delta_l = \{v_{l+1}^1, v_{l+1}^2, \dots, v_{l+1}^{s(u_{l+1})}\}$$

with $l(v_{l+1}^1) = n_{l+1,1}, l(v_{l+1}^2) = n_{l+1,2}, \dots, l(v_{l+1}^{s(u_{l+1})}) = n_{l+1,s(u_{l+1})}$. Then let the manifold correspondent to the vertex u_{l+1} with an intersection dimension $\geq d$ with manifolds correspondent to these vertices $v_{l+1}^1, v_{l+1}^2, \dots, v_{l+1}^{s(u_{l+1})}$ and define a vertex set $\Delta_{l+1} = \Delta_l \cup \{u_{l+1}\}$.

STEP 4. Repeat steps 2 and 3 until a vertex set $\Delta_t = V_{\geq 1}$ has been constructed. This construction is ended if there are no vertices $w \in V(G)$ with $l(w) = 0$, i.e., $V_{\geq 1} = V(G)$. Otherwise, go to the next step.

STEP 5. For $\forall w \in V(G[n_1, n_2, \dots, n_m]) \setminus V_{\geq 1}$, assume $N_{G[n_1, n_2, \dots, n_m]}(w) = \{w_1, w_2, \dots, w_e\}$. Let all these manifolds correspondent to vertices w_1, w_2, \dots, w_e intersects at one point simultaneously and define a vertex set $\Delta_{t+1}^* = \Delta_t \cup \{w\}$.

STEP 6. Repeat STEP 5 for vertices in $V(G[n_1, n_2, \dots, n_m]) \setminus V_{\geq 1}$. This construction is finally ended until a vertex set $\Delta_{t+h}^* = V(G[n_1, n_2, \dots, n_m])$ has been constructed.

As soon as the vertex set Δ_{t+h}^* has been constructed, we get a finitely combinatorial manifold \widetilde{M} . It can be easily verified that $\widetilde{M} \in \mathcal{H}^d(n_1, n_2, \dots, n_m)$ by our construction way. \square

2.2 Combinatorial equivalence

For a finitely combinatorial manifold \widetilde{M} in $\mathcal{H}^d(n_1, n_2, \dots, n_m)$, denoted by $G[\widetilde{M}(n_1, n_2, \dots, n_m)]$ and $G[\widetilde{M}]$ the correspondent labelled graph in $\mathcal{G}(n_1, n_2, \dots, n_m)$ and the graph deleted labels on $G[\widetilde{M}(n_1, n_2, \dots, n_m)]$, $C(n_i)$ all these vertices with a label n_i for $1 \leq i \leq m$, respectively.

Definition 2.2 *Two finitely combinatorial manifolds $\widetilde{M}_1(n_1, n_2, \dots, n_m), \widetilde{M}_2(k_1, k_2, \dots, k_l)$ are called equivalent if these correspondent labelled graphs*

$$G[\widetilde{M}_1(n_1, n_2, \dots, n_m)] \cong G[\widetilde{M}_2(k_1, k_2, \dots, k_l)].$$

Notice that if $\widetilde{M}_1(n_1, n_2, \dots, n_m), \widetilde{M}_2(k_1, k_2, \dots, k_l)$ are equivalent, then we can get that $\{n_1, n_2, \dots, n_m\} = \{k_1, k_2, \dots, k_l\}$ and $G[\widetilde{M}_1] \cong G[\widetilde{M}_2]$. Reversing this idea enables us classifying finitely combinatorial manifolds in $\mathcal{H}^d(n_1, n_2, \dots, n_m)$ by the action of automorphism groups of these correspondent graphs without labels.

Definition 2.3 *A labelled connected graph $G[\widetilde{M}(n_1, n_2, \dots, n_m)]$ is combinatorial unique if all these correspondent finitely combinatorial manifolds $\widetilde{M}(n_1, n_2, \dots, n_m)$ are equivalent.*

A labelled graph $G[n_1, n_2, \dots, n_m]$ is called *class-transitive* if the automorphism group $\text{Aut}G$ is transitive on $\{C(n_i), 1 \leq i \leq m\}$. We find a characteristic for combinatorially unique graphs.

Theorem 2.4 *A labelled connected graph $G[n_1, n_2, \dots, n_m]$ is combinatorially unique if and only if it is class-transitive.*

Proof For two integers $i, j, 1 \leq i, j \leq m$, re-label vertices in $C(n_i)$ by n_j and vertices in $C(n_j)$ by n_i in $G[n_1, n_2, \dots, n_m]$. Then we get a new labelled graph $G'[n_1, n_2, \dots, n_m]$ in $\mathcal{G}[n_1, n_2, \dots, n_m]$. According to Theorem 2.3, we can get two finitely combinatorial manifolds $\widetilde{M}_1(n_1, n_2, \dots, n_m)$ and $\widetilde{M}_2(k_1, k_2, \dots, k_l)$ correspondent to $G[n_1, n_2, \dots, n_m]$ and $G'[n_1, n_2, \dots, n_m]$.

Now if $G[n_1, n_2, \dots, n_m]$ is combinatorially unique, we know $\widetilde{M}_1(n_1, n_2, \dots, n_m)$ is equivalent to $\widetilde{M}_2(k_1, k_2, \dots, k_l)$, i.e., there is an automorphism $\theta \in \text{Aut}G$ such that $C^\theta(n_i) = C(n_j)$ for $\forall i, j, 1 \leq i, j \leq m$.

On the other hand, if $G[n_1, n_2, \dots, n_m]$ is class-transitive, then for integers $i, j, 1 \leq i, j \leq m$, there is an automorphism $\tau \in \text{Aut}G$ such that $C^\tau(n_i) = C(n_j)$. Whence, for any re-labelled graph $G'[n_1, n_2, \dots, n_m]$, we find that

$$G[n_1, n_2, \dots, n_m] \cong G'[n_1, n_2, \dots, n_m],$$

which implies that these finitely combinatorial manifolds correspondent to $G[n_1, n_2, \dots, n_m]$ and $G'[n_1, n_2, \dots, n_m]$ are combinatorially equivalent, i.e., $G[n_1, n_2, \dots, n_m]$ is combinatorially unique. \square

Now assume that for parameters $t_{i1}, t_{i2}, \dots, t_{is_i}$, we have known an enufunction

$$C_{M^{n_i}}[x_{i1}, x_{i2}, \dots] = \sum_{t_{i1}, t_{i2}, \dots, t_{is}} n_i(t_{i1}, t_{i2}, \dots, t_{is}) x_{i1}^{t_{i1}} x_{i2}^{t_{i2}} \cdots x_{is}^{t_{is}}$$

for n_i -manifolds, where $n_i(t_{i1}, t_{i2}, \dots, t_{is})$ denotes the number of non-homeomorphic n_i -manifolds with parameters $t_{i1}, t_{i2}, \dots, t_{is}$. For instance the enufunction for compact 2-manifolds with parameter genera is

$$C_{\widetilde{M}}[x](2) = 1 + \sum_{p \geq 1} 2x^p.$$

Consider the action of $\text{Aut}G[n_1, n_2, \dots, n_m]$ on $G[n_1, n_2, \dots, n_m]$. If the number of orbits of the automorphism group $\text{Aut}G[n_1, n_2, \dots, n_m]$ action on $\{C(n_i), 1 \leq i \leq m\}$ is π_0 , then we can only get $\pi_0!$ non-equivalent combinatorial manifolds correspondent to the labelled graph $G[n_1, n_2, \dots, n_m]$ similar to Theorem 2.4. Calculation shows that there are $l!$ orbits action by its automorphism group for a complete $(s_1 + s_2 + \dots + s_l)$ -partite graph $K(k_1^{s_1}, k_2^{s_2}, \dots, k_l^{s_l})$, where $k_i^{s_i}$ denotes that there are s_i partite sets of order k_i in this graph for any integer $i, 1 \leq i \leq l$, particularly, for $K(n_1, n_2, \dots, n_m)$ with $n_i \neq n_j$ for $i, j, 1 \leq i, j \leq m$, the number of orbits action by its automorphism group is $m!$. Summarizing all these discussions, we get an enufunction for these finitely combinatorial manifolds $\widetilde{M}(n_1, n_2, \dots, n_m)$ correspondent to a labelled graph $G[n_1, n_2, \dots, n_m]$ in $\mathcal{G}(n_1, n_2, \dots, n_m)$ with each label ≥ 1 .

Theorem 2.5 *Let $G[n_1, n_2, \dots, n_m]$ be a labelled graph in $\mathcal{G}(n_1, n_2, \dots, n_m)$ with each label ≥ 1 . For an integer $i, 1 \leq i \leq m$, let the enufunction of non-homeomorphic n_i -manifolds with given parameters t_1, t_2, \dots , be $C_{M^{n_i}}[x_{i1}, x_{i2}, \dots]$ and π_0 the number of orbits of the automorphism group $\text{Aut}G[n_1, n_2, \dots, n_m]$ action on $\{C(n_i), 1 \leq i \leq m\}$, then the enufunction of combinatorial manifolds $\widetilde{M}(n_1, n_2, \dots, n_m)$ correspondent to a labelled graph $G[n_1, n_2, \dots, n_m]$ is*

$$C_{\widetilde{M}}(\vec{x}) = \pi_0! \prod_{i=1}^m C_{M^{n_i}}[x_{i1}, x_{i2}, \dots],$$

particularly, if $G[n_1, n_2, \dots, n_m] = K(k_1^{s_1}, k_2^{s_2}, \dots, k_m^{s_m})$ such that the number of partite sets labelled with n_i is s_i for any integer $i, 1 \leq i \leq m$, then the enufnction correspondent to $K(k_1^{s_1}, k_2^{s_2}, \dots, k_m^{s_m})$ is

$$C_{\widetilde{M}}(\bar{x}) = m! \prod_{i=1}^m C_{M^{n_i}}[x_{i1}, x_{i2}, \dots]$$

and the enufnction correspondent to a complete graph K_m is

$$C_{\widetilde{M}}(\bar{x}) = \prod_{i=1}^m C_{M^{n_i}}[x_{i1}, x_{i2}, \dots].$$

Proof Notice that the number of non-equivalent finitely combinatorial manifolds correspondent to $G[n_1, n_2, \dots, n_m]$ is

$$\pi_0 \prod_{i=1}^m n_i(t_{i1}, t_{i2}, \dots, t_{is})$$

for parameters $t_{i1}, t_{i2}, \dots, t_{is}, 1 \leq i \leq m$ by the product principle of enumeration. Whence, the enufnction of combinatorial manifolds $\widetilde{M}(n_1, n_2, \dots, n_m)$ correspondent to a labelled graph $G[n_1, n_2, \dots, n_m]$ is

$$\begin{aligned} C_{\widetilde{M}}(\bar{x}) &= \sum_{t_{i1}, t_{i2}, \dots, t_{is}} (\pi_0 \prod_{i=1}^m n_i(t_{i1}, t_{i2}, \dots, t_{is})) \prod_{i=1}^m x_{i1}^{t_{i1}} x_{i2}^{t_{i2}} \dots x_{is}^{t_{is}} \\ &= \pi_0! \prod_{i=1}^m C_{M^{n_i}}[x_{i1}, x_{i2}, \dots]. \quad \square \end{aligned}$$

2.3 Homotopy classes

Denote by $f \simeq g$ two homotopic mappings f and g . Following the same pattern of homotopic spaces, we define homotopically combinatorial manifolds in the next.

Definition 2.4 *Two finitely combinatorial manifolds $\widetilde{M}(k_1, k_2, \dots, k_l)$ and $\widetilde{M}(n_1, n_2, \dots, n_m)$ are said to be homotopic if there exist continuous maps*

$$\begin{aligned} f &: \widetilde{M}(k_1, k_2, \dots, k_l) \rightarrow \widetilde{M}(n_1, n_2, \dots, n_m), \\ g &: \widetilde{M}(n_1, n_2, \dots, n_m) \rightarrow \widetilde{M}(k_1, k_2, \dots, k_l) \end{aligned}$$

such that $gf \simeq \text{identity}$: $\widetilde{M}(k_1, k_2, \dots, k_l) \rightarrow \widetilde{M}(k_1, k_2, \dots, k_l)$ and $fg \simeq \text{identity}$: $\widetilde{M}(n_1, n_2, \dots, n_m) \rightarrow \widetilde{M}(n_1, n_2, \dots, n_m)$.

For equivalent homotopically combinatorial manifolds, we know the following result under these correspondent manifolds being homotopic. For this objective, we need an important lemma in algebraic topology.

Lemma 2.1(Gluing Lemma, [16]) *Assume that a space X is a finite union of closed subsets: $X = \bigcup_{i=1}^n X_i$. If for some space Y , there are continuous maps $f_i : X_i \rightarrow Y$ that agree on overlaps, i.e., $f_i|_{X_i \cap X_j} = f_j|_{X_i \cap X_j}$ for all i, j , then there exists a unique continuous $f : X \rightarrow Y$ with $f|_{X_i} = f_i$ for all i .*

Theorem 2.6 *Let $\widetilde{M}(n_1, n_2, \dots, n_m)$ and $\widetilde{M}(k_1, k_2, \dots, k_l)$ be finitely combinatorial manifolds with an equivalence $\varpi : G[\widetilde{M}(n_1, n_2, \dots, n_m)] \rightarrow G[\widetilde{M}(k_1, k_2, \dots, k_l)]$. If for $\forall M_1, M_2 \in V(G[\widetilde{M}(n_1, n_2, \dots, n_m)])$, M_i is homotopic to $\varpi(M_i)$ with homotopic mappings $f_{M_i} : M_i \rightarrow \varpi(M_i)$, $g_{M_i} : \varpi(M_i) \rightarrow M_i$ such that $f_{M_i}|_{M_i \cap M_j} = f_{M_j}|_{M_i \cap M_j}$, $g_{M_i}|_{M_i \cap M_j} = g_{M_j}|_{M_i \cap M_j}$ providing $(M_i, M_j) \in E(G[\widetilde{M}(n_1, n_2, \dots, n_m)])$ for $1 \leq i, j \leq m$, then $\widetilde{M}(n_1, n_2, \dots, n_m)$ is homotopic to $\widetilde{M}(k_1, k_2, \dots, k_l)$.*

Proof By the Gluing Lemma, there are continuous mappings

$$f : \widetilde{M}(n_1, n_2, \dots, n_m) \rightarrow \widetilde{M}(k_1, k_2, \dots, k_l)$$

and

$$g : \widetilde{M}(k_1, k_2, \dots, k_l) \rightarrow \widetilde{M}(n_1, n_2, \dots, n_m)$$

such that

$$f|_M = f_M \text{ and } g|_{\varpi(M)} = g_{\varpi(M)}$$

for $\forall M \in V(G[\widetilde{M}(n_1, n_2, \dots, n_m)])$. Thereby, we also get that

$$gf \simeq \text{identity} : \widetilde{M}(k_1, k_2, \dots, k_l) \rightarrow \widetilde{M}(k_1, k_2, \dots, k_l)$$

and

$$fg \simeq \text{identity} : \widetilde{M}(n_1, n_2, \dots, n_m) \rightarrow \widetilde{M}(n_1, n_2, \dots, n_m)$$

as a result of $g_M f_M \simeq \text{identity} : M \rightarrow M$, $f_M g_M \simeq \text{identity} : \varpi(M) \rightarrow \varpi(M)$. \square

We have known that a finitely combinatorial manifold $\widetilde{M}(n_1, n_2, \dots, n_m)$ is d -pathwise connected for some integers $1 \leq d \leq n_1$. This consequence enables us considering fundamental d -groups of finitely combinatorial manifolds.

Definition 2.5 Let $\widetilde{M}(n_1, n_2, \dots, n_m)$ be a finitely combinatorial manifold. For an integer $d, 1 \leq d \leq n_1$ and $\forall x \in \widetilde{M}(n_1, n_2, \dots, n_m)$, a fundamental d -group at the point x , denoted by $\pi^d(\widetilde{M}(n_1, n_2, \dots, n_m), x)$ is defined to be a group generated by all homotopic classes of closed d -paths based at x .

If $d = 1$ and $\widetilde{M}(n_1, n_2, \dots, n_m)$ is just a manifold M , we get that

$$\pi^d(\widetilde{M}(n_1, n_2, \dots, n_m), x) = \pi(M, x).$$

Whence, fundamental d -groups are a generalization of fundamental groups in topology. We obtain the following characteristics for fundamental d -groups of finitely combinatorial manifolds.

Theorem 2.7 *Let $\widetilde{M}(n_1, n_2, \dots, n_m)$ be a d -connected finitely combinatorial manifold with $1 \leq d \leq n_1$. Then*

(1) for $\forall x \in \widetilde{M}(n_1, n_2, \dots, n_m)$,

$$\pi^d(\widetilde{M}(n_1, n_2, \dots, n_m), x) \cong \left(\bigoplus_{M \in V(G^d)} \pi^d(M) \right) \bigoplus \pi(G^d),$$

where $G^d = G^d[\widetilde{M}(n_1, n_2, \dots, n_m)]$, $\pi^d(M)$, $\pi(G^d)$ denote the fundamental d -groups of a manifold M and the graph G^d , respectively and

(2) for $\forall x, y \in \widetilde{M}(n_1, n_2, \dots, n_m)$,

$$\pi^d(\widetilde{M}(n_1, n_2, \dots, n_m), x) \cong \pi^d(\widetilde{M}(n_1, n_2, \dots, n_m), y).$$

Proof For proving the conclusion (1), we only need to prove that for any cycle \widetilde{C} in $\widetilde{M}(n_1, n_2, \dots, n_m)$, there are elements $C_1^M, C_2^M, \dots, C_{l(M)}^M \in \pi^d(M)$, $\alpha_1, \alpha_2, \dots, \alpha_{\beta(G^d)} \in \pi(G^d)$ and integers a_i^M, b_j for $\forall M \in V(G^d)$ and $1 \leq i \leq l(M)$, $1 \leq j \leq c(G^d) \leq \beta(G^d)$ such that

$$\widetilde{C} \equiv \sum_{M \in V(G^d)} \sum_{i=1}^{l(M)} a_i^M C_i^M + \sum_{j=1}^{c(G^d)} b_j \alpha_j \pmod{2}$$

and it is unique. Let $C_1^M, C_2^M, \dots, C_{b(M)}^M$ be a base of $\pi^d(M)$ for $\forall M \in V(G^d)$. Since \widetilde{C} is a closed trail, there must exist integers $k_i^M, l_j, 1 \leq i \leq b(M), 1 \leq j \leq \beta(G^d)$ and h_P for an open d -path on \widetilde{C} such that

$$\widetilde{C} = \sum_{M \in V(G^d)} \sum_{i=1}^{b(M)} k_i^M C_i^M + \sum_{j=1}^{\beta(G^d)} l_j \alpha_j + \sum_{P \in \Delta} h_P P,$$

where $h_P \equiv 0 \pmod{2}$ and Δ denotes all of these open d -paths on \widetilde{C} . Now let

$$\{a_i^M | 1 \leq i \leq l(M)\} = \{k_i^M | k_i^M \neq 0 \text{ and } 1 \leq i \leq b(M)\},$$

$$\{b_j | 1 \leq j \leq c(G^d)\} = \{l_j | l_j \neq 0, 1 \leq j \leq \beta(G^d)\}.$$

Then we get that

$$\tilde{C} \equiv \sum_{M \in V(G^d)} \sum_{i=1}^{l(M)} a_i^M C_i^M + \sum_{j=1}^{c(G^d)} b_j \alpha_j \pmod{2}. \quad (2.4)$$

If there is another decomposition

$$\tilde{C} \equiv \sum_{M \in V(G^d)} \sum_{i=1}^{l'(M)} a_i'^M C_i^M + \sum_{j=1}^{c'(G^d)} b_j' \alpha_j \pmod{2},$$

not loss of generality, assume $l'(M) \leq l(M)$ and $c'(M) \leq c(M)$, then we know that

$$\sum_{M \in V(G^d)} \sum_{i=1}^{l(M)} (a_i^M - a_i'^M) C_i^M + \sum_{j=1}^{c(G^d)} (b_j - b_j') \alpha_j = 0,$$

where $a_i'^M = 0$ if $i > l'(M)$, $b_j' = 0$ if $j' > c'(M)$. Since $C_i^M, 1 \leq i \leq b(M)$ and $\alpha_j, 1 \leq j \leq \beta(G^d)$ are bases of the fundamental group $\pi(M)$ and $\pi(G^d)$ respectively, we must have

$$a_i^M = a_i'^M, 1 \leq i \leq l(M) \text{ and } b_j = b_j', 1 \leq j \leq c(G^d).$$

Whence, the decomposition (2.4) is unique.

For proving the conclusion (2), notice that $\widetilde{M}(n_1, n_2, \dots, n_m)$ is pathwise d -connected. Let $P^d(x, y)$ be a d -path connecting points x and y in $\widetilde{M}(n_1, n_2, \dots, n_m)$. Define

$$\omega_*(C) = P^d(x, y)C(P^d)^{-1}(x, y)$$

for $\forall C \in \widetilde{M}(n_1, n_2, \dots, n_m)$. Then it can be checked immediately that

$$\omega_* : \pi^d(\widetilde{M}(n_1, n_2, \dots, n_m), x) \rightarrow \pi^d(\widetilde{M}(n_1, n_2, \dots, n_m), y)$$

is an isomorphism. □

A d -connected finitely combinatorial manifold $\widetilde{M}(n_1, n_2, \dots, n_m)$ is said to be *simply d -connected* if $\pi^d(\widetilde{M}(n_1, n_2, \dots, n_m), x)$ is trivial. As a consequence, we get the following result by Theorem 2.7.

Corollary 2.3 *A d -connected finitely combinatorial manifold $\widetilde{M}(n_1, n_2, \dots, n_m)$ is simply d -connected if and only if*

- (1) *for $\forall M \in V(G^d[\widetilde{M}(n_1, n_2, \dots, n_m)])$, M is simply d -connected and*
- (2) *$G^d[\widetilde{M}(n_1, n_2, \dots, n_m)]$ is a tree.*

Proof According to the decomposition for $\pi^d(\widetilde{M}(n_1, n_2, \dots, n_m), x)$ in Theorem 2.7, it is trivial if and only if $\pi(M)$ and $\pi(G^d)$ both are trivial for $\forall M \in V(G^d[\widetilde{M}(n_1, n_2, \dots, n_m)])$, i.e M is simply d -connected and G^d is a tree. \square

For equivalent homotopically combinatorial manifolds, we also get a criterion under a homotopically equivalent mapping in the next.

Theorem 2.8 *If $f : \widetilde{M}(n_1, n_2, \dots, n_m) \rightarrow \widetilde{M}(k_1, k_2, \dots, k_l)$ is a homotopic equivalence, then for any integer $d, 1 \leq d \leq n_1$ and $x \in \widetilde{M}(n_1, n_2, \dots, n_m)$,*

$$\pi^d(\widetilde{M}(n_1, n_2, \dots, n_m), x) \cong \pi^d(\widetilde{M}(k_1, k_2, \dots, k_l), f(x)).$$

Proof Notice that f can natural induce a homomorphism

$$f_\pi : \pi^d(\widetilde{M}(n_1, n_2, \dots, n_m), x) \rightarrow \pi^d(\widetilde{M}(k_1, k_2, \dots, k_l), f(x))$$

defined by $f_\pi \langle g \rangle = \langle f(g) \rangle$ for $\forall g \in \pi^d(\widetilde{M}(n_1, n_2, \dots, n_m), x)$ since it can be easily checked that $f_\pi(gh) = f_\pi(g)f_\pi(h)$ for $\forall g, h \in \pi^d(\widetilde{M}(n_1, n_2, \dots, n_m), x)$. We only need to prove that f_π is an isomorphism.

By definition, there is also a homotopic equivalence $g : \widetilde{M}(k_1, k_2, \dots, k_l) \rightarrow \widetilde{M}(n_1, n_2, \dots, n_m)$ such that $gf \simeq \text{identity} : \widetilde{M}(n_1, n_2, \dots, n_m) \rightarrow \widetilde{M}(n_1, n_2, \dots, n_m)$. Thereby, $g_\pi f_\pi = (gf)_\pi = \mu(\text{identity})_\pi :$

$$\pi^d(\widetilde{M}(n_1, n_2, \dots, n_m), x) \rightarrow \pi^s(\widetilde{M}(n_1, n_2, \dots, n_m), x),$$

where μ is an isomorphism induced by a certain d -path from x to $gf(x)$ in $\widetilde{M}(n_1, n_2, \dots, n_m)$. Therefore, $g_\pi f_\pi$ is an isomorphism. Whence, f_π is a monomorphism and g_π is an epimorphism.

Similarly, apply the same argument to the homotopy

$$fg \simeq \text{identity} : \widetilde{M}(k_1, k_2, \dots, k_l) \rightarrow \widetilde{M}(k_1, k_2, \dots, k_l),$$

we get that $f_\pi g_\pi = (fg)_\pi = \nu(\text{identity})_{pi} :$

$$\pi^d(\widetilde{M}(k_1, k_2, \dots, k_l), x) \rightarrow \pi^s(\widetilde{M}(k_1, k_2, \dots, k_l), x),$$

where ν is an isomorphism induced by a d -path from $fg(x)$ to x in $\widetilde{M}(k_1, k_2, \dots, k_l)$. So g_π is a monomorphism and f_π is an epimorphism. Combining these facts enables us to conclude that $f_\pi : \pi^d(\widetilde{M}(n_1, n_2, \dots, n_m), x) \rightarrow \pi^d(\widetilde{M}(k_1, k_2, \dots, k_l), f(x))$ is an isomorphism. \square

Corollary 2.4 If $f : \widetilde{M}(n_1, n_2, \dots, n_m) \rightarrow \widetilde{M}(k_1, k_2, \dots, k_l)$ is a homeomorphism, then for any integer $d, 1 \leq d \leq n_1$ and $x \in \widetilde{M}(n_1, n_2, \dots, n_m)$,

$$\pi^d(\widetilde{M}(n_1, n_2, \dots, n_m), x) \cong \pi^d(\widetilde{M}(k_1, k_2, \dots, k_l), f(x)).$$

2.4 Euler-Poincare characteristic

It is well-known that the integer

$$\chi(\mathfrak{M}) = \sum_{i=0}^{\infty} (-1)^i \alpha_i$$

with α_i the number of i -dimensional cells in a CW -complex \mathfrak{M} is defined to be the Euler-Poincare characteristic of this complex. In this subsection, we get the Euler-Poincare characteristic for finitely combinatorial manifolds. For this objective, define a clique sequence $\{Cl(i)\}_{i \geq 1}$ in the graph $G[\widetilde{M}]$ by the following programming.

STEP 1. Let $Cl(G[\widetilde{M}]) = l_0$. Construct

$$Cl(l_0) = \{K_1^{l_0}, K_2^{l_0}, \dots, K_p^{l_0} | K_i^{l_0} \succ G[\widetilde{M}] \text{ and } K_i^{l_0} \cap K_j^{l_0} = \emptyset, \\ \text{or a vertex} \in V(G[\widetilde{M}]) \text{ for } i \neq j, 1 \leq i, j \leq p\}.$$

STEP 2. Let $G_1 = \bigcup_{K^{l_0} \in Cl(l_0)} K^{l_0}$ and $Cl(G[\widetilde{M}] \setminus G_1) = l_1$. Construct

$$Cl(l_1) = \{K_1^{l_1}, K_2^{l_1}, \dots, K_q^{l_1} | K_i^{l_1} \succ G[\widetilde{M}] \text{ and } K_i^{l_1} \cap K_j^{l_1} = \emptyset \\ \text{or a vertex} \in V(G[\widetilde{M}]) \text{ for } i \neq j, 1 \leq i, j \leq q\}.$$

STEP 3. Assume we have constructed $Cl(l_{k-1})$ for an integer $k \geq 1$. Let $G_k = \bigcup_{K^{l_{k-1}} \in Cl(l_{k-1})} K^{l_{k-1}}$ and $Cl(G[\widetilde{M}] \setminus (G_1 \cup \dots \cup G_k)) = l_k$. We construct

$$Cl(l_k) = \{K_1^{l_k}, K_2^{l_k}, \dots, K_r^{l_k} | K_i^{l_k} \succ G[\widetilde{M}] \text{ and } K_i^{l_k} \cap K_j^{l_k} = \emptyset, \\ \text{or a vertex} \in V(G[\widetilde{M}]) \text{ for } i \neq j, 1 \leq i, j \leq r\}.$$

STEP 4. Continue STEP 3 until we find an integer t such that there are no edges in $G[\widetilde{M}] \setminus \bigcup_{i=1}^t G_i$.

By this clique sequence $\{Cl(i)\}_{i \geq 1}$, we can calculate the Euler-Poincare characteristic of finitely combinatorial manifolds.

Theorem 2.9 *Let \widetilde{M} be a finitely combinatorial manifold. Then*

$$\chi(\widetilde{M}) = \sum_{K^k \in Cl(k), k \geq 2} \sum_{M_{i_j} \in V(K^k), 1 \leq j \leq s \leq k} (-1)^{s+1} \chi(M_{i_1} \cap \cdots \cap M_{i_s})$$

Proof Denoted the numbers of all these i -dimensional cells in a combinatorial manifold \widetilde{M} or in a manifold M by $\tilde{\alpha}_i$ and $\alpha_i(M)$. If $G[\widetilde{M}]$ is nothing but a complete graph K^k with $V(G[\widetilde{M}]) = \{M_1, M_2, \dots, M_k\}$, $k \geq 2$, by applying the inclusion-exclusion principle and the definition of Euler-Poincare characteristic we get that

$$\begin{aligned} \chi(\widetilde{M}) &= \sum_{i=0}^{\infty} (-1)^i \tilde{\alpha}_i \\ &= \sum_{i=0}^{\infty} (-1)^i \sum_{M_{i_j} \in V(K^k), 1 \leq j \leq s \leq k} (-1)^{s+1} \alpha_i(M_{i_1} \cap \cdots \cap M_{i_s}) \\ &= \sum_{M_{i_j} \in V(K^k), 1 \leq j \leq s \leq k} (-1)^{s+1} \sum_{i=0}^{\infty} (-1)^i \alpha_i(M_{i_1} \cap \cdots \cap M_{i_s}) \\ &= \sum_{M_{i_j} \in V(K^k), 1 \leq j \leq s \leq k} (-1)^{s+1} \chi(M_{i_1} \cap \cdots \cap M_{i_s}) \end{aligned}$$

for instance, $\chi(\widetilde{M}) = \chi(M_1) + \chi(M_2) - \chi(M_1 \cap M_2)$ if $G[\widetilde{M}] = K^2$ and $V(G[\widetilde{M}]) = \{M_1, M_2\}$. By the definition of clique sequence of $G[\widetilde{M}]$, we finally obtain that

$$\chi(\widetilde{M}) = \sum_{K^k \in Cl(k), k \geq 2} \sum_{M_{i_j} \in V(K^k), 1 \leq j \leq s \leq k} (-1)^{s+1} \chi(M_{i_1} \cap \cdots \cap M_{i_s}). \quad \square$$

If $G[\widetilde{M}]$ is just one of some special graphs, we can get interesting consequences by Theorem 2.9.

Corollary 2.5 *Let \widetilde{M} be a finitely combinatorial manifold. If $G[\widetilde{M}]$ is K^3 -free, then*

$$\chi(\widetilde{M}) = \sum_{M \in V(G[\widetilde{M}])} \chi^2(M) - \sum_{(M_1, M_2) \in E(G[\widetilde{M}])} \chi(M_1 \cap M_2).$$

Particularly, if $\dim(M_1 \cap M_2)$ is a constant for any $(M_1, M_2) \in E(G[\widetilde{M}])$, then

$$\chi(\widetilde{M}) = \sum_{M \in V(G[\widetilde{M}])} \chi^2(M) - \chi(M_1 \cap M_2) |E(G[\widetilde{M}])|.$$

Proof Notice that $G[\widetilde{M}]$ is K^3 -free, we get that

$$\begin{aligned} \chi(\widetilde{M}) &= \sum_{(M_1, M_2) \in E(G[\widetilde{M}])} (\chi(M_1) + \chi(M_2) - \chi(M_1 \cap M_2)) \\ &= \sum_{(M_1, M_2) \in E(G[\widetilde{M}])} (\chi(M_1) + \chi(M_2)) + \sum_{(M_1, M_2) \in E(G[\widetilde{M}])} \chi(M_1 \cap M_2) \\ &= \sum_{M \in V(G[\widetilde{M}])} \chi^2(M) - \sum_{(M_1, M_2) \in E(G[\widetilde{M}])} \chi(M_1 \cap M_2). \quad \square \end{aligned}$$

Since the Euler-Poincare characteristic of a manifold M is 0 if $\dim M \equiv 1 \pmod{2}$, we get the following consequence.

Corollary 2.6 *Let \widetilde{M} be a finitely combinatorial manifold with odd dimension number for any intersection of k manifolds with $k \geq 2$. Then*

$$\chi(\widetilde{M}) = \sum_{M \in V(G[\widetilde{M}])} \chi(M).$$

§3. Differential structures on combinatorial manifolds

We introduce differential structures on finitely combinatorial manifolds and characterize them in this section.

3.1 Tangent vector fields

Definition 3.1 *For a given integer sequence $1 \leq n_1 < n_2 < \cdots < n_m$, a combinatorially C^h differential manifold $(\widetilde{M}(n_1, n_2, \cdots, n_m); \widetilde{\mathcal{A}})$ is a finitely combinatorial manifold $\widetilde{M}(n_1, n_2, \cdots, n_m)$, $\widetilde{M}(n_1, n_2, \cdots, n_m) = \bigcup_{i \in I} U_i$, endowed with a atlas*

$\tilde{\mathcal{A}} = \{(U_\alpha; \varphi_\alpha) | \alpha \in I\}$ on $\tilde{M}(n_1, n_2, \dots, n_m)$ for an integer $h, h \geq 1$ with conditions following hold.

- (1) $\{U_\alpha; \alpha \in I\}$ is an open covering of $\tilde{M}(n_1, n_2, \dots, n_m)$;
- (2) For $\forall \alpha, \beta \in I$, local charts $(U_\alpha; \varphi_\alpha)$ and $(U_\beta; \varphi_\beta)$ are equivalent, i.e., $U_\alpha \cap U_\beta = \emptyset$ or $U_\alpha \cap U_\beta \neq \emptyset$ but the overlap maps

$$\varphi_\alpha \varphi_\beta^{-1} : \varphi_\beta(U_\alpha \cap U_\beta) \rightarrow \varphi_\alpha(U_\alpha) \quad \text{and} \quad \varphi_\beta \varphi_\alpha^{-1} : \varphi_\alpha(U_\alpha \cap U_\beta) \rightarrow \varphi_\beta(U_\beta)$$

are C^h mappings;

- (3) $\tilde{\mathcal{A}}$ is maximal, i.e., if $(U; \varphi)$ is a local chart of $\tilde{M}(n_1, n_2, \dots, n_m)$ equivalent with one of local charts in $\tilde{\mathcal{A}}$, then $(U; \varphi) \in \tilde{\mathcal{A}}$.

Denote by $(\tilde{M}(n_1, n_2, \dots, n_m); \tilde{\mathcal{A}})$ a combinatorially differential manifold. A finitely combinatorial manifold $\tilde{M}(n_1, n_2, \dots, n_m)$ is said to be smooth if it is endowed with a C^∞ differential structure.

Let $\tilde{\mathcal{A}}$ be an atlas on $\tilde{M}(n_1, n_2, \dots, n_m)$. Choose a local chart $(U; \varpi)$ in $\tilde{\mathcal{A}}$. For $\forall p \in (U; \varpi)$, if $\varpi_p : U_p \rightarrow \bigcup_{i=1}^{s(p)} B^{n_i(p)}$ and $\hat{s}(p) = \dim(\bigcap_{i=1}^{s(p)} B^{n_i(p)})$, the following $s(p) \times n_{s(p)}$ matrix $[\varpi(p)]$

$$[\varpi(p)] = \begin{bmatrix} \frac{x^{11}}{s(p)} & \dots & \frac{x^{1\hat{s}(p)}}{s(p)} & x^{1(\hat{s}(p)+1)} & \dots & x^{1n_1} & \dots & 0 \\ \frac{x^{21}}{s(p)} & \dots & \frac{x^{2\hat{s}(p)}}{s(p)} & x^{2(\hat{s}(p)+1)} & \dots & x^{2n_2} & \dots & 0 \\ \dots & \dots & \dots & \dots & \dots & \dots & \dots & \dots \\ \frac{x^{s(p)1}}{s(p)} & \dots & \frac{x^{s(p)\hat{s}(p)}}{s(p)} & x^{s(p)(\hat{s}(p)+1)} & \dots & \dots & x^{s(p)n_{s(p)}-1} & x^{s(p)n_{s(p)}} \end{bmatrix}$$

with $x^{is} = x^{js}$ for $1 \leq i, j \leq s(p), 1 \leq s \leq \hat{s}(p)$ is called the *coordinate matrix* of p . For emphasize ϖ is a matrix, we often denote local charts in a combinatorially differential manifold by $(U; [\varpi])$. Using the coordinate matrix system of a combinatorially differential manifold $(\tilde{M}(n_1, n_2, \dots, n_m); \tilde{\mathcal{A}})$, we introduce the conception of C^h mappings and functions in the next.

Definition 3.2 Let $\tilde{M}_1(n_1, n_2, \dots, n_m), \tilde{M}_2(k_1, k_2, \dots, k_l)$ be smoothly combinatorial manifolds and

$$f : \tilde{M}_1(n_1, n_2, \dots, n_m) \rightarrow \tilde{M}_2(k_1, k_2, \dots, k_l)$$

be a mapping, $p \in \widetilde{M}_1(n_1, n_2, \dots, n_m)$. If there are local charts $(U_p; [\varpi_p])$ of p on $\widetilde{M}_1(n_1, n_2, \dots, n_m)$ and $(V_{f(p)}; [\omega_{f(p)}])$ of $f(p)$ with $f(U_p) \subset V_{f(p)}$ such that the composition mapping

$$\widetilde{f} = [\omega_{f(p)}] \circ f \circ [\varpi_p]^{-1} : [\varpi_p](U_p) \rightarrow [\omega_{f(p)}](V_{f(p)})$$

is a C^h mapping, then f is called a C^h mapping at the point p . If f is C^h at any point p of $\widetilde{M}_1(n_1, n_2, \dots, n_m)$, then f is called a C^h mapping. Particularly, if $\widetilde{M}_2(k_1, k_2, \dots, k_l) = \mathbf{R}$, f is called a C^h function on $\widetilde{M}_1(n_1, n_2, \dots, n_m)$. In the extreme $h = \infty$, these terminologies are called smooth mappings and functions, respectively. Denote by \mathcal{X}_p all these C^∞ functions at a point $p \in \widetilde{M}(n_1, n_2, \dots, n_m)$.

For the existence of combinatorially differential manifolds, we know the following result.

Theorem 3.1 *Let $\widetilde{M}(n_1, n_2, \dots, n_m)$ be a finitely combinatorial manifold and $d, 1 \leq d \leq n_1$ an integer. If $\forall M \in V(G^d[\widetilde{M}(n_1, n_2, \dots, n_m)])$ is C^h differential and $\forall (M_1, M_2) \in E(G^d[\widetilde{M}(n_1, n_2, \dots, n_m)])$ there exist atlas*

$$\mathcal{A}_1 = \{(V_x; \varphi_x) | \forall x \in M_1\} \quad \mathcal{A}_2 = \{(W_y; \psi_y) | \forall y \in M_2\}$$

such that $\varphi_x|_{V_x \cap W_y} = \psi_y|_{V_x \cap W_y}$ for $\forall x \in M_1, y \in M_2$, then there is a differential structures

$$\widetilde{\mathcal{A}} = \{(U_p; [\varpi_p]) | \forall p \in \widetilde{M}(n_1, n_2, \dots, n_m)\}$$

such that $(\widetilde{M}(n_1, n_2, \dots, n_m); \widetilde{\mathcal{A}})$ is a combinatorially C^h differential manifold.

Proof By definition, We only need to show that we can always choose a neighborhood U_p and a homoeomorphism $[\varpi_p]$ for each $p \in \widetilde{M}(n_1, n_2, \dots, n_m)$ satisfying these conditions (1) – (3) in definition 3.1.

By assumption, each manifold $\forall M \in V(G^d[\widetilde{M}(n_1, n_2, \dots, n_m)])$ is C^h differential, accordingly there is an index set I_M such that $\{U_\alpha; \alpha \in I_M\}$ is an open covering of M , local charts $(U_\alpha; \varphi_\alpha)$ and $(U_\beta; \varphi_\beta)$ of M are equivalent and $\mathcal{A} = \{(U; \varphi)\}$ is maximal. Since for $\forall p \in \widetilde{M}(n_1, n_2, \dots, n_m)$, there is a local chart $(U_p; [\varpi_p])$ of p such that $[\varpi_p] : U_p \rightarrow \bigcup_{i=1}^{s(p)} B^{n_i(p)}$, i.e., p is an intersection point of manifolds $M^{n_i(p)}, 1 \leq i \leq s(p)$. By assumption each manifold $M^{n_i(p)}$ is C^h differential, there exists a local chart $(V_p^i; \varphi_p^i)$ while the point $p \in M^{n_i(p)}$ such that $\varphi_p^i \rightarrow B^{n_i(p)}$. Now we define

$$U_p = \bigcup_{i=1}^{s(p)} V_p^i.$$

Then applying the Gluing Lemma again, we know that there is a homoeomorphism $[\varpi_p]$ on U_p such that

$$[\varpi_p]|_{M^{n_i(p)}} = \varphi_p^i$$

for any integer $i, 1 \leq i \leq s(p)$. Thereafter,

$$\tilde{\mathcal{A}} = \{(U_p; [\varpi_p]) | \forall p \in \tilde{M}(n_1, n_2, \dots, n_m)\}$$

is a C^h differential structure on $\tilde{M}(n_1, n_2, \dots, n_m)$ satisfying conditions (1) – (3). Thereby $(\tilde{M}(n_1, n_2, \dots, n_m); \tilde{\mathcal{A}})$ is a combinatorially C^h differential manifold. \square

Definition 3.3 Let $(\tilde{M}(n_1, n_2, \dots, n_m), \tilde{\mathcal{A}})$ be a smoothly combinatorial manifold and $p \in \tilde{M}(n_1, n_2, \dots, n_m)$. A tangent vector v at p is a mapping $v : \mathcal{X}_p \rightarrow \mathbf{R}$ with conditions following hold.

- (1) $\forall g, h \in \mathcal{X}_p, \forall \lambda \in \mathbf{R}, v(h + \lambda h) = v(g) + \lambda v(h);$
- (2) $\forall g, h \in \mathcal{X}_p, v(gh) = v(g)h(p) + g(p)v(h).$

Denoted all tangent vectors at $p \in \tilde{M}(n_1, n_2, \dots, n_m)$ by $T_p \tilde{M}(n_1, n_2, \dots, n_m)$ and define addition+and scalar multiplication-for $\forall u, v \in T_p \tilde{M}(n_1, n_2, \dots, n_m), \lambda \in \mathbf{R}$ and $f \in \mathcal{X}_p$ by

$$(u + v)(f) = u(f) + v(f), \quad (\lambda u)(f) = \lambda \cdot u(f).$$

Then it can be shown immediately that $T_p \tilde{M}(n_1, n_2, \dots, n_m)$ is a vector space under these two operations+and.

Theorem 3.2 For any point $p \in \tilde{M}(n_1, n_2, \dots, n_m)$ with a local chart $(U_p; [\varphi_p])$, the dimension of $T_p \tilde{M}(n_1, n_2, \dots, n_m)$ is

$$\dim T_p \tilde{M}(n_1, n_2, \dots, n_m) = \hat{s}(p) + \sum_{i=1}^{s(p)} (n_i - \hat{s}(p))$$

with a basis matrix

$$\left[\frac{\partial}{\partial \bar{x}} \right]_{s(p) \times n_{s(p)}} =$$

$$\left[\begin{array}{cccccccc} \frac{1}{s(p)} \frac{\partial}{\partial x^{11}} & \cdots & \frac{1}{s(p)} \frac{\partial}{\partial x^{1\widehat{s}(p)}} & \frac{\partial}{\partial x^{1(\widehat{s}(p)+1)}} & \cdots & \frac{\partial}{\partial x^{1n_1}} & \cdots & 0 \\ \frac{1}{s(p)} \frac{\partial}{\partial x^{21}} & \cdots & \frac{1}{s(p)} \frac{\partial}{\partial x^{2\widehat{s}(p)}} & \frac{\partial}{\partial x^{2(\widehat{s}(p)+1)}} & \cdots & \frac{\partial}{\partial x^{2n_2}} & \cdots & 0 \\ \cdots & \cdots & \cdots & \cdots & \cdots & \cdots & \cdots & \cdots \\ \frac{1}{s(p)} \frac{\partial}{\partial x^{s(p)1}} & \cdots & \frac{1}{s(p)} \frac{\partial}{\partial x^{s(p)\widehat{s}(p)}} & \frac{\partial}{\partial x^{s(p)(\widehat{s}(p)+1)}} & \cdots & \cdots & \frac{\partial}{\partial x^{s(p)(n_s(p)-1)}} & \frac{\partial}{\partial x^{s(p)n_s(p)}} \end{array} \right]$$

where $x^{il} = x^{jl}$ for $1 \leq i, j \leq s(p), 1 \leq l \leq \widehat{s}(p)$, namely there is a smoothly functional matrix $[v_{ij}]_{s(p) \times n_{s(p)}}$ such that for any tangent vector \bar{v} at a point p of $\widetilde{M}(n_1, n_2, \dots, n_m)$,

$$\bar{v} = [v_{ij}]_{s(p) \times n_{s(p)}} \odot \left[\frac{\partial}{\partial x} \right]_{s(p) \times n_{s(p)}},$$

where $[a_{ij}]_{k \times l} \odot [b_{ts}]_{k \times l} = \sum_{i=1}^k \sum_{j=1}^l a_{ij} b_{ij}$.

Proof For $\forall f \in \mathcal{X}_p$, let $\tilde{f} = f \cdot [\varphi_p]^{-1} \in \mathcal{X}_{[\varphi_p](p)}$. We only need to prove that f can be spanned by elements in

$$\left\{ \frac{\partial}{\partial x^{hj}} \Big|_p \mid 1 \leq j \leq \widehat{s}(p) \right\} \cup \left(\bigcup_{i=1}^{s(p)} \bigcup_{j=\widehat{s}(p)+1}^{n_i} \left\{ \frac{\partial}{\partial x^{ij}} \Big|_p \mid 1 \leq j \leq s \right\} \right), \quad (3.1)$$

for a given integer $h, 1 \leq h \leq s(p)$, namely (3.1) is a basis of $T_p \widetilde{M}(n_1, n_2, \dots, n_m)$.

In fact, for $\forall \bar{x} \in [\varphi_p](U_p)$, since \tilde{f} is smooth, we know that

$$\begin{aligned} \tilde{f}(\bar{x}) - \tilde{f}(\bar{x}_0) &= \int_0^1 \frac{d}{dt} \tilde{f}(\bar{x}_0 + t(\bar{x} - \bar{x}_0)) dt \\ &= \sum_{i=1}^{s(p)} \sum_{j=1}^{n_i} \eta_{\widehat{s}(p)}^j(x^{ij} - x_0^{ij}) \int_0^1 \frac{\partial \tilde{f}}{\partial x^{ij}}(\bar{x}_0 + t(\bar{x} - \bar{x}_0)) dt \end{aligned}$$

in a spherical neighborhood of the point p in $[\varphi_p](U_p) \subset \mathbf{R}^{\widehat{s}(p)-s(p)\widehat{s}(p)+n_1+n_2+\dots+n_{s(p)}}$ with $[\varphi_p](p) = \bar{x}_0$, where

$$\eta_{\widehat{s}(p)}^j = \begin{cases} \frac{1}{\widehat{s}(p)}, & \text{if } 1 \leq j \leq \widehat{s}(p), \\ 1, & \text{otherwise.} \end{cases}$$

Define

$$\tilde{g}_{ij}(\bar{x}) = \int_0^1 \frac{\partial \tilde{f}}{\partial x^{ij}}(\bar{x}_0 + t(\bar{x} - \bar{x}_0)) dt$$

and $g_{ij} = \tilde{g}_{ij} \cdot [\varphi_p]$. Then we find that

$$\begin{aligned} g_{ij}(p) = \tilde{g}_{ij}(\bar{x}_0) &= \frac{\partial \tilde{f}}{\partial x^{ij}}(\bar{x}_0) \\ &= \frac{\partial (f \cdot [\varphi_p]^{-1})}{\partial x^{ij}}([\varphi_p](p)) = \frac{\partial f}{\partial x^{ij}}(p). \end{aligned}$$

Therefore, for $\forall q \in U_p$, there are g_{ij} , $1 \leq i \leq s(p)$, $1 \leq j \leq n_i$ such that

$$f(q) = f(p) + \sum_{i=1}^{s(p)} \sum_{j=1}^{n_i} \eta_{\tilde{s}(p)}^j(x^{ij} - x_0^{ij}) g_{ij}(p).$$

Now let $\bar{v} \in T_p \widetilde{M}(n_1, n_2, \dots, n_m)$. Application of the condition (2) in Definition 3.1 shows that

$$v(f(p)) = 0, \quad \text{and} \quad v(\eta_{\tilde{s}(p)}^j x_0^{ij}) = 0.$$

Accordingly, we obtain that

$$\begin{aligned} \bar{v}(f) &= \bar{v}(f(p) + \sum_{i=1}^{s(p)} \sum_{j=1}^{n_i} \eta_{\tilde{s}(p)}^j(x^{ij} - x_0^{ij}) g_{ij}(p)) \\ &= \bar{v}(f(p)) + \sum_{i=1}^{s(p)} \sum_{j=1}^{n_i} \bar{v}(\eta_{\tilde{s}(p)}^j(x^{ij} - x_0^{ij}) g_{ij}(p)) \\ &= \sum_{i=1}^{s(p)} \sum_{j=1}^{n_i} (\eta_{\tilde{s}(p)}^j g_{ij}(p) \bar{v}(x^{ij} - x_0^{ij}) + (x^{ij}(p) - x_0^{ij}) \bar{v}(\eta_{\tilde{s}(p)}^j g_{ij}(p))) \\ &= \sum_{i=1}^{s(p)} \sum_{j=1}^{n_i} \eta_{\tilde{s}(p)}^j \frac{\partial f}{\partial x^{ij}}(p) \bar{v}(x^{ij}) \\ &= \sum_{i=1}^{s(p)} \sum_{j=1}^{n_i} \bar{v}(x^{ij}) \eta_{\tilde{s}(p)}^j \frac{\partial}{\partial x^{ij}}|_p(f) = [v_{ij}]_{s(p) \times n_{s(p)}} \odot \left[\frac{\partial}{\partial \bar{x}} \right]_{s(p) \times n_{s(p)}}|_p(f). \end{aligned}$$

Therefore, we get that

$$\bar{v} = [v_{ij}]_{s(p) \times n_{s(p)}} \odot \left[\frac{\partial}{\partial \bar{x}} \right]_{s(p) \times n_{s(p)}}. \quad (3.2)$$

The formula (3.2) shows that any tangent vector \bar{v} in $T_p\widetilde{M}(n_1, n_2, \dots, n_m)$ can be spanned by elements in (3.1).

Notice that all elements in (3.1) are also linearly independent. Otherwise, if there are numbers $a^{ij}, 1 \leq i \leq s(p), 1 \leq j \leq n_i$ such that

$$\left(\sum_{j=1}^{\widehat{s}(p)} a^{hj} \frac{\partial}{\partial x^{hj}} + \sum_{i=1}^{s(p)} \sum_{j=\widehat{s}(p)+1}^{n_i} a^{ij} \frac{\partial}{\partial x^{ij}} \right) \Big|_p = 0,$$

then we get that

$$a^{ij} = \left(\sum_{j=1}^{\widehat{s}(p)} a^{hj} \frac{\partial}{\partial x^{hj}} + \sum_{i=1}^{s(p)} \sum_{j=\widehat{s}(p)+1}^{n_i} a^{ij} \frac{\partial}{\partial x^{ij}} \right) (x^{ij}) = 0$$

for $1 \leq i \leq s(p), 1 \leq j \leq n_i$. Therefore, (3.1) is a basis of the tangent vector space $T_p\widetilde{M}(n_1, n_2, \dots, n_m)$ at the point $p \in (\widetilde{M}(n_1, n_2, \dots, n_m); \widetilde{\mathcal{A}})$. \square

By Theorem 3.2, if $s(p) = 1$ for any point $p \in (\widetilde{M}(n_1, n_2, \dots, n_m); \widetilde{\mathcal{A}})$, then $\dim T_p\widetilde{M}(n_1, n_2, \dots, n_m) = n_1$. This can only happen while $\widetilde{M}(n_1, n_2, \dots, n_m)$ is combined by one manifold. As a consequence, we get a well-known result in classical differential geometry again.

Corollary 3.1([2]) *Let $(M^n; \mathcal{A})$ be a smooth manifold and $p \in M^n$. Then*

$$\dim T_p M^n = n$$

with a basis

$$\left\{ \frac{\partial}{\partial x^i} \Big|_p \mid 1 \leq i \leq n \right\}.$$

Definition 3.4 *For $\forall p \in (\widetilde{M}(n_1, n_2, \dots, n_m); \widetilde{\mathcal{A}})$, the dual space $T_p^*\widetilde{M}(n_1, n_2, \dots, n_m)$ is called a co-tangent vector space at p .*

Definition 3.5 *For $f \in \mathcal{X}_p, d \in T_p^*\widetilde{M}(n_1, n_2, \dots, n_m)$ and $\bar{v} \in T_p\widetilde{M}(n_1, n_2, \dots, n_m)$, the action of d on f , called a differential operator $d: \mathcal{X}_p \rightarrow \mathbf{R}$, is defined by*

$$df = \bar{v}(f).$$

Then we immediately obtain the result following.

Theorem 3.3 For $\forall p \in (\widetilde{M}(n_1, n_2, \dots, n_m); \widetilde{\mathcal{A}})$ with a local chart $(U_p; [\varphi_p])$, the dimension of $T_p^* \widetilde{M}(n_1, n_2, \dots, n_m)$ is

$$\dim T_p^* \widetilde{M}(n_1, n_2, \dots, n_m) = \widehat{s}(p) + \sum_{i=1}^{s(p)} (n_i - \widehat{s}(p))$$

with a basis matrix

$$[d\bar{x}]_{s(p) \times n_{s(p)}} = \begin{bmatrix} \frac{dx^{11}}{s(p)} & \dots & \frac{dx^{1\widehat{s}(p)}}{s(p)} & dx^{1(\widehat{s}(p)+1)} & \dots & dx^{1n_1} & \dots & 0 \\ \frac{dx^{21}}{s(p)} & \dots & \frac{dx^{2\widehat{s}(p)}}{s(p)} & dx^{2(\widehat{s}(p)+1)} & \dots & dx^{2n_2} & \dots & 0 \\ \dots & \dots & \dots & \dots & \dots & \dots & \dots & \dots \\ \frac{dx^{s(p)1}}{s(p)} & \dots & \frac{dx^{s(p)\widehat{s}(p)}}{s(p)} & dx^{s(p)(\widehat{s}(p)+1)} & \dots & \dots & dx^{s(p)n_{s(p)}-1} & dx^{s(p)n_{s(p)}} \end{bmatrix}$$

where $x^{il} = x^{jl}$ for $1 \leq i, j \leq s(p), 1 \leq l \leq \widehat{s}(p)$, namely for any co-tangent vector d at a point p of $\widetilde{M}(n_1, n_2, \dots, n_m)$, there is a smoothly functional matrix $[u_{ij}]_{s(p) \times s(p)}$ such that,

$$d = [u_{ij}]_{s(p) \times n_{s(p)}} \odot [d\bar{x}]_{s(p) \times n_{s(p)}}.$$

3.2 Tensor fields

Definition 3.6 Let $\widetilde{M}(n_1, n_2, \dots, n_m)$ be a smoothly combinatorial manifold and $p \in \widetilde{M}(n_1, n_2, \dots, n_m)$. A tensor of type (r, s) at the point p on $\widetilde{M}(n_1, n_2, \dots, n_m)$ is an $(r + s)$ -multilinear function τ ,

$$\tau : \underbrace{T_p^* \widetilde{M} \times \dots \times T_p^* \widetilde{M}}_r \times \underbrace{T_p \widetilde{M} \times \dots \times T_p \widetilde{M}}_s \rightarrow \mathbf{R},$$

where $T_p \widetilde{M} = T_p \widetilde{M}(n_1, n_2, \dots, n_m)$ and $T_p^* \widetilde{M} = T_p^* \widetilde{M}(n_1, n_2, \dots, n_m)$.

Denoted by $T_s^r(p, \widetilde{M})$ all tensors of type (r, s) at a point p of $\widetilde{M}(n_1, n_2, \dots, n_m)$. Then we know its structure by Theorems 3.2 and 3.3.

Theorem 3.4 Let $\widetilde{M}(n_1, n_2, \dots, n_m)$ be a smoothly combinatorial manifold and $p \in \widetilde{M}(n_1, n_2, \dots, n_m)$. Then

$$T_s^r(p, \widetilde{M}) = \underbrace{T_p \widetilde{M} \otimes \cdots \otimes T_p \widetilde{M}}_r \otimes \underbrace{T_p^* \widetilde{M} \otimes \cdots \otimes T_p^* \widetilde{M}}_s,$$

where $T_p \widetilde{M} = T_p \widetilde{M}(n_1, n_2, \dots, n_m)$ and $T_p^* \widetilde{M} = T_p^* \widetilde{M}(n_1, n_2, \dots, n_m)$, particularly,

$$\dim T_s^r(p, \widetilde{M}) = (\widehat{s}(p) + \sum_{i=1}^{s(p)} (n_i - \widehat{s}(p)))^{r+s}.$$

Proof By definition and multilinear algebra, any tensor t of type (r, s) at the point p can be uniquely written as

$$t = \sum t_{j_1 \dots j_s}^{i_1 \dots i_r} \frac{\partial}{\partial x^{i_1 j_1}} \Big|_p \otimes \cdots \otimes \frac{\partial}{\partial x^{i_r j_r}} \Big|_p \otimes dx^{k_1 l_1} \otimes \cdots \otimes dx^{k_s l_s}$$

for components $t_{j_1 \dots j_s}^{i_1 \dots i_r} \in \mathbf{R}$ according to Theorems 3.2 and 3.3, where $1 \leq i_h, k_h \leq s(p)$ and $1 \leq j_h \leq i_h, 1 \leq l_h \leq k_h$ for $1 \leq h \leq r$. As a consequence, we obtain that

$$T_s^r(p, \widetilde{M}) = \underbrace{T_p \widetilde{M} \otimes \cdots \otimes T_p \widetilde{M}}_r \otimes \underbrace{T_p^* \widetilde{M} \otimes \cdots \otimes T_p^* \widetilde{M}}_s.$$

Since $\dim T_p \widetilde{M} = \dim T_p^* \widetilde{M} = \widehat{s}(p) + \sum_{i=1}^{s(p)} (n_i - \widehat{s}(p))$ by Theorems 3.2 and 3.3, we also know that

$$\dim T_s^r(p, \widetilde{M}) = (\widehat{s}(p) + \sum_{i=1}^{s(p)} (n_i - \widehat{s}(p)))^{r+s}. \quad \square$$

Definition 3.7 Let $T_s^r(\widetilde{M}) = \bigcup_{p \in \widetilde{M}} T_s^r(p, \widetilde{M})$ for a smoothly combinatorial manifold

$\widetilde{M} = \widetilde{M}(n_1, n_2, \dots, n_m)$. A tensor field of type (r, s) on $\widetilde{M}(n_1, n_2, \dots, n_m)$ is a mapping $\tau : \widetilde{M}(n_1, n_2, \dots, n_m) \rightarrow T_s^r(\widetilde{M})$ such that $\tau(p) \in T_s^r(p, \widetilde{M})$ for $\forall p \in \widetilde{M}(n_1, n_2, \dots, n_m)$.

A k -form on $\widetilde{M}(n_1, n_2, \dots, n_m)$ is a tensor field $\omega \in T_0^r(\widetilde{M})$. Denoted all k -form of $\widetilde{M}(n_1, n_2, \dots, n_m)$ by $\Lambda^k(\widetilde{M})$ and $\Lambda(\widetilde{M}) = \bigoplus_{k=0}^{\widehat{s}(p) - s(p)\widehat{s}(p) + \sum_{i=1}^{s(p)} n_i} \Lambda^k(\widetilde{M})$, $\mathcal{X}(\widetilde{M}) = \bigcup_{p \in \widetilde{M}} \mathcal{X}_p$.

Similar to the classical differential geometry, we can also define operations $\varphi \wedge \psi$ for $\forall \varphi, \psi \in T_s^r(\widetilde{M})$, $[X, Y]$ for $\forall X, Y \in \mathcal{X}(\widetilde{M})$ and obtain a *Lie algebra* under the

commutator. For the exterior differentiations on combinatorial manifolds, we find results following.

Theorem 3.5 *Let \widetilde{M} be a smoothly combinatorial manifold. Then there is a unique exterior differentiation $\widetilde{d} : \Lambda(\widetilde{M}) \rightarrow \Lambda(\widetilde{M})$ such that for any integer $k \geq 1$, $\widetilde{d}(\Lambda^k) \subset \Lambda^{k+1}(\widetilde{M})$ with conditions following hold.*

(1) \widetilde{d} is linear, i.e., for $\forall \varphi, \psi \in \Lambda(\widetilde{M})$, $\lambda \in \mathbf{R}$,

$$\widetilde{d}(\varphi + \lambda\psi) = \widetilde{d}\varphi \wedge \psi + \lambda\widetilde{d}\psi$$

and for $\varphi \in \Lambda^k(\widetilde{M})$, $\psi \in \Lambda(\widetilde{M})$,

$$\widetilde{d}(\varphi \wedge \psi) = \widetilde{d}\varphi \wedge \psi + (-1)^k \varphi \wedge \widetilde{d}\psi.$$

(2) For $f \in \Lambda^0(\widetilde{M})$, $\widetilde{d}f$ is the differentiation of f .

(3) $\widetilde{d}^2 = \widetilde{d} \cdot \widetilde{d} = 0$.

(4) \widetilde{d} is a local operator, i.e., if $U \subset V \subset \widetilde{M}$ are open sets and $\alpha \in \Lambda^k(V)$, then $\widetilde{d}(\alpha|_U) = (\widetilde{d}\alpha)|_U$.

Proof Let $(U; [\varphi])$, where $[\varphi] : p \rightarrow \bigcup_{i=1}^{s(p)} [\varphi](p) = [\varphi(p)]$ be a local chart for a point $p \in \widetilde{M}$ and $\alpha = \alpha_{(\mu_1\nu_1)\dots(\mu_k\nu_k)} dx^{\mu_1\nu_1} \wedge \dots \wedge dx^{\mu_k\nu_k}$ with $1 \leq \nu_j \leq n_{\mu_i}$ for $1 \leq \mu_i \leq s(p)$, $1 \leq i \leq k$. We first establish the uniqueness. If $k = 0$, the local formula $\widetilde{d}\alpha = \frac{\partial \alpha}{\partial x^{\mu\nu}} dx^{\mu\nu}$ applied to the coordinates $x^{\mu\nu}$ with $1 \leq \nu_j \leq n_{\mu_i}$ for $1 \leq \mu_i \leq s(p)$, $1 \leq i \leq k$ shows that the differential of $x^{\mu\nu}$ is 1-form $dx^{\mu\nu}$. From (3), $\widetilde{d}(x^{\mu\nu}) = 0$, which combining with (1) shows that $\widetilde{d}(dx^{\mu_1\nu_1} \wedge \dots \wedge dx^{\mu_k\nu_k}) = 0$. This, again by (1),

$$\widetilde{d}\alpha = \frac{\partial \alpha_{(\mu_1\nu_1)\dots(\mu_k\nu_k)}}{\partial x^{\mu\nu}} dx^{\mu\nu} \wedge dx^{\mu_1\nu_1} \wedge \dots \wedge dx^{\mu_k\nu_k}. \quad (3.3)$$

and \widetilde{d} is uniquely determined on U by properties (1) – (3) and by (4) on any open subset of \widetilde{M} .

For existence, define on every local chart $(U; [\varphi])$ the operator \widetilde{d} by (3.3). Then (2) is trivially verified as is \mathbf{R} -linearity. If $\beta = \beta_{(\sigma_1 s_1)\dots(\sigma_l s_l)} dx^{\sigma_1 s_1} \wedge \dots \wedge dx^{\sigma_l s_l} \in \Lambda^l(U)$, then

$$\begin{aligned}
\tilde{d}(\alpha \wedge \beta) &= \tilde{d}(\alpha_{(\mu_1\nu_1)\dots(\mu_k\psi_k)}\beta_{(\sigma_1\varsigma_1)\dots(\sigma_l\varsigma_l)}dx^{\mu_1\nu_1} \wedge \dots \wedge dx^{\mu_k\nu_k} \wedge dx^{\sigma_1\varsigma_1} \wedge \dots \wedge dx^{\sigma_l\varsigma_l}) \\
&= \left(\frac{\partial\alpha_{(\mu_1\nu_1)\dots(\mu_k\psi_k)}}{\partial x^{\mu\nu}}\beta_{(\sigma_1\varsigma_1)\dots(\sigma_l\varsigma_l)} + \alpha_{(\mu_1\nu_1)\dots(\mu_k\psi_k)}\right) \\
&\quad \times \frac{\partial\beta_{(\sigma_1\varsigma_1)\dots(\sigma_l\varsigma_l)}}{\partial x^{\mu\nu}}dx^{\mu_1\nu_1} \wedge \dots \wedge dx^{\mu_k\nu_k} \wedge dx^{\sigma_1\varsigma_1} \wedge \dots \wedge dx^{\sigma_l\varsigma_l} \\
&= \frac{\partial\alpha_{(\mu_1\nu_1)\dots(\mu_k\psi_k)}}{\partial x^{\mu\nu}}dx^{\mu_1\nu_1} \wedge \dots \wedge dx^{\mu_k\nu_k} \wedge \beta_{(\sigma_1\varsigma_1)\dots(\sigma_l\varsigma_l)}dx^{\sigma_1\varsigma_1} \wedge \dots \wedge dx^{\sigma_l\varsigma_l} \\
&\quad + (-1)^k\alpha_{(\mu_1\nu_1)\dots(\mu_k\psi_k)}dx^{\mu_1\nu_1} \dots \wedge dx^{\mu_k\nu_k} \wedge \frac{\partial\beta_{(\sigma_1\varsigma_1)\dots(\sigma_l\varsigma_l)}}{\partial x^{\mu\nu}}dx^{\sigma_1\varsigma_1} \dots \wedge dx^{\sigma_l\varsigma_l} \\
&= \tilde{d}\alpha \wedge \beta + (-1)^k\alpha \wedge \tilde{d}\beta
\end{aligned}$$

and (1) is verified. For (3), symmetry of the second partial derivatives shows that

$$\tilde{d}(\tilde{d}\alpha) = \frac{\partial^2\alpha_{(\mu_1\nu_1)\dots(\mu_k\psi_k)}}{\partial x^{\mu\nu}\partial x^{\sigma\varsigma}}dx^{\mu_1\nu_1} \wedge \dots \wedge dx^{\mu_k\nu_k} \wedge dx^{\sigma_1\varsigma_1} \wedge \dots \wedge dx^{\sigma_l\varsigma_l} = 0.$$

Thus, in every local chart $(U; [\varphi])$, (3.3) defines an operator \tilde{d} satisfying (1)-(3). It remains to be shown that \tilde{d} really defines an operator \tilde{d} on any open set and (4) holds. To do so, it suffices to show that this definition is chart independent. Let \tilde{d}' be the operator given by (3.3) on a local chart $(U'; [\varphi'])$, where $U \cap U' \neq \emptyset$. Since \tilde{d}' also satisfies (1) – (3) and the local uniqueness has already been proved, $\tilde{d}'\alpha = \tilde{d}\alpha$ on $U \cap U'$. Whence, (4) thus follows. \square

Corollary 3.2 *Let $\widetilde{M} = \widetilde{M}(n_1, n_2, \dots, n_m)$ be a smoothly combinatorial manifold and $d_M : \Lambda^k(M) \rightarrow \Lambda^{k+1}(M)$ the unique exterior differentiation on M with conditions following hold for $M \in V(G^l[\widetilde{M}(n_1, n_2, \dots, n_m)])$ where, $1 \leq l \leq \min\{n_1, n_2, \dots, n_m\}$.*

(1) d_M is linear, i.e., for $\forall\varphi, \psi \in \Lambda(M)$, $\lambda \in \mathbf{R}$,

$$d_M(\varphi + \lambda\psi) = d_M\varphi + \lambda d_M\psi.$$

(2) For $\varphi \in \Lambda^r(M)$, $\psi \in \Lambda(M)$,

$$d_M(\varphi \wedge \psi) = d_M\varphi + (-1)^r\varphi \wedge d_M\psi.$$

(3) For $f \in \Lambda^0(M)$, $d_M f$ is the differentiation of f .

(4) $d_M^2 = d_M \cdot d_M = 0$.

Then

$$\tilde{d}|_M = d_M.$$

Proof By Theorem 2.4.5 in [1], d_M exists uniquely for any smoothly manifold M . Now since \tilde{d} is a local operator on \tilde{M} , i.e., for any open subset $U_\mu \subset \tilde{M}$, $\tilde{d}(\alpha|_{U_\mu}) = (\tilde{d}\alpha)|_{U_\mu}$ and there is an index set J such that $M = \bigcup_{\mu \in J} U_\mu$, we finally get that

$$\tilde{d}|_M = d_M$$

by the uniqueness of \tilde{d} and d_M . \square

Theorem 3.6 *Let $\omega \in \Lambda^1(\tilde{M})$. Then for $\forall X, Y \in \mathcal{X}(\tilde{M})$,*

$$\tilde{d}\omega(X, Y) = X(\omega(Y)) - Y(\omega(X)) - \omega([X, Y]).$$

Proof Denote by $\alpha(X, Y)$ the right hand side of the formula. We know that $\alpha : \tilde{M} \times \tilde{M} \rightarrow C^\infty(\tilde{M})$. It can be checked immediately that α is bilinear and for $\forall X, Y \in \mathcal{X}(\tilde{M}), f \in C^\infty(\tilde{M})$,

$$\begin{aligned} \alpha(fX, Y) &= fX(\omega(Y)) - Y(\omega(fX)) - \omega([fX, Y]) \\ &= fX(\omega(Y)) - Y(f\omega(X)) - \omega(f[X, Y] - Y(f)X) \\ &= f\alpha(X, Y) \end{aligned}$$

and

$$\alpha(X, fY) = -\alpha(fY, X) = -f\alpha(Y, X) = f\alpha(X, Y)$$

by definition. Accordingly, α is a differential 2-form. We only need to prove that for a local chart $(U, [\varphi])$,

$$\alpha|_U = \tilde{d}\omega|_U.$$

In fact, assume $\omega|_U = \omega_{\mu\nu}dx^{\mu\nu}$. Then

$$\begin{aligned} (\tilde{d}\omega)|_U = \tilde{d}(\omega|_U) &= \frac{\partial \omega_{\mu\nu}}{\partial x^{\sigma\varsigma}} dx^{\sigma\varsigma} \wedge dx^{\mu\nu} \\ &= \frac{1}{2} \left(\frac{\partial \omega_{\mu\nu}}{\partial x^{\sigma\varsigma}} - \frac{\partial \omega_{\varsigma\tau}}{\partial x^{\mu\nu}} \right) dx^{\sigma\varsigma} \wedge dx^{\mu\nu}. \end{aligned}$$

On the other hand, $\alpha|_U = \frac{1}{2}\alpha(\frac{\partial}{\partial x^{\mu\nu}}, \frac{\partial}{\partial x^{\sigma\varsigma}})dx^{\sigma\varsigma} \wedge dx^{\mu\nu}$, where

$$\begin{aligned} \alpha(\frac{\partial}{\partial x^{\mu\nu}}, \frac{\partial}{\partial x^{\sigma\varsigma}}) &= \frac{\partial}{\partial x^{\sigma\varsigma}}(\omega(\frac{\partial}{\partial x^{\mu\nu}})) - \frac{\partial}{\partial x^{\mu\nu}}(\omega(\frac{\partial}{\partial x^{\sigma\varsigma}})) \\ &\quad - \omega([\frac{\partial}{\partial x^{\mu\nu}} - \frac{\partial}{\partial x^{\sigma\varsigma}}]) \\ &= \frac{\partial\omega_{\mu\nu}}{\partial x^{\sigma\varsigma}} - \frac{\partial\omega_{\sigma\varsigma}}{\partial x^{\mu\nu}}. \end{aligned}$$

Therefore, $\tilde{d}\omega|_U = \alpha|_U$. □

3.3 Connections on tensors

We introduce connections on tensors of smoothly combinatorial manifolds by the next definition.

Definition 3.8 *Let \tilde{M} be a smoothly combinatorial manifold. A connection on tensors of \tilde{M} is a mapping $\tilde{D} : \mathcal{X}(\tilde{M}) \times T_s^r \tilde{M} \rightarrow T_s^r \tilde{M}$ with $\tilde{D}_X \tau = \tilde{D}(X, \tau)$ such that for $\forall X, Y \in \mathcal{X}(\tilde{M})$, $\tau, \pi \in T_s^r(\tilde{M})$, $\lambda \in \mathbf{R}$ and $f \in C^\infty(\tilde{M})$,*

- (1) $\tilde{D}_{X+fY} \tau = \tilde{D}_X \tau + f \tilde{D}_Y \tau$; and $\tilde{D}_X(\tau + \lambda\pi) = \tilde{D}_X \tau + \lambda \tilde{D}_X \pi$;
- (2) $\tilde{D}_X(\tau \otimes \pi) = \tilde{D}_X \tau \otimes \pi + \sigma \otimes \tilde{D}_X \pi$;
- (3) for any contraction C on $T_s^r(\tilde{M})$,

$$\tilde{D}_X(C(\tau)) = C(\tilde{D}_X \tau).$$

We get results following for these connections on tensors of smoothly combinatorial manifolds.

Theorem 3.7 *Let \tilde{M} be a smoothly combinatorial manifold. Then there exists a connection \tilde{D} locally on \tilde{M} with a form*

$$(\tilde{D}_X \tau)|_U = X^{\sigma\varsigma} \tau_{(\kappa_1 \lambda_1)(\kappa_2 \lambda_2) \dots (\kappa_s \lambda_s), (\mu\nu)} \frac{\partial}{\partial x^{\mu_1 \nu_1}} \otimes \dots \otimes \frac{\partial}{\partial x^{\mu_r \nu_r}} \otimes dx^{\kappa_1 \lambda_1} \otimes \dots \otimes dx^{\kappa_s \lambda_s}$$

for $\forall Y \in \mathcal{X}(\tilde{M})$ and $\tau \in T_s^r(\tilde{M})$, where

$$\begin{aligned}
\tau_{(\kappa_1 \lambda_1)(\kappa_2 \lambda_2) \cdots (\kappa_s \lambda_s), (\mu \nu)}^{(\mu_1 \nu_1)(\mu_2 \nu_2) \cdots (\mu_r \nu_r)} &= \frac{\partial \tau_{(\kappa_1 \lambda_1)(\kappa_2 \lambda_2) \cdots (\kappa_s \lambda_s)}^{(\mu_1 \nu_1)(\mu_2 \nu_2) \cdots (\mu_r \nu_r)}}{\partial x^{\mu \nu}} \\
&+ \sum_{a=1}^r \tau_{(\kappa_1 \lambda_1)(\kappa_2 \lambda_2) \cdots (\kappa_s \lambda_s)}^{(\mu_1 \nu_1) \cdots (\mu_{a-1} \nu_{a-1})(\sigma \varsigma)(\mu_{a+1} \nu_{a+1}) \cdots (\mu_r \nu_r)} \Gamma_{(\sigma \varsigma)(\mu \nu)}^{\mu_a \nu_a} \\
&- \sum_{b=1}^s \tau_{(\kappa_1 \lambda_1) \cdots (\kappa_{b-1} \lambda_{b-1})(\mu \nu)(\sigma_{b+1} \varsigma_{b+1}) \cdots (\kappa_s \lambda_s)}^{(\mu_1 \nu_1)(\mu_2 \nu_2) \cdots (\mu_r \nu_r)} \Gamma_{(\sigma_b \varsigma_b)(\mu \nu)}^{\sigma \varsigma}
\end{aligned}$$

and $\Gamma_{(\sigma \varsigma)(\mu \nu)}^{\kappa \lambda}$ is a function determined by

$$\tilde{D} \frac{\partial}{\partial x^{\mu \nu}} \frac{\partial}{\partial x^{\sigma \varsigma}} = \Gamma_{(\sigma \varsigma)(\mu \nu)}^{\kappa \lambda} \frac{\partial}{\partial x^{\sigma \varsigma}}$$

on $(U_p; [\varphi_p]) = (U_p; x^{\mu \nu})$ of a point $p \in \tilde{M}$, also called the coefficient on a connection.

Proof We first prove that any connection \tilde{D} on smoothly combinatorial manifolds \tilde{M} is local by definition, namely for $X_1, X_2 \in \mathcal{X}(\tilde{M})$ and $\tau_1, \tau_2 \in T_s^r(\tilde{M})$, if $X_1|_U = X_2|_U$ and $\tau_1|_U = \tau_2|_U$, then $(\tilde{D}_{X_1} \tau_1)|_U = (\tilde{D}_{X_2} \tau_2)|_U$. For this objective, we need to prove that $(\tilde{D}_{X_1} \tau_1)|_U = (\tilde{D}_{X_1} \tau_2)|_U$ and $(\tilde{D}_{X_1} \tau_1)|_U = (\tilde{D}_{X_2} \tau_1)|_U$. Since their proofs are similar, we check the first only.

In fact, if $\tau = 0$, then $\tau = \tau - \tau$. By the definition of connection,

$$\tilde{D}_X \tau = \tilde{D}_X(\tau - \tau) = \tilde{D}_X \tau - \tilde{D}_X \tau = 0.$$

Now let $p \in U$. Then there is a neighborhood V_p of p such that \bar{V} is compact and $\bar{V} \subset U$. By a result in topology, i.e., for two open sets V_p, U of $\mathbf{R}^{\hat{s}(p)-s(p)\hat{s}(p)+n_1+\cdots+n_s(p)}$ with compact \bar{V}_p and $\bar{V}_p \subset U$, there exists a function $f \in C^\infty(\mathbf{R}^{\hat{s}(p)-s(p)\hat{s}(p)+n_1+\cdots+n_s(p)})$ such that $0 \leq f \leq 1$ and $f|_{V_p} \equiv 1$, $f|_{\mathbf{R}^{\hat{s}(p)-s(p)\hat{s}(p)+n_1+\cdots+n_s(p)} \setminus U} \equiv 0$, we find that $f \cdot (\tau_2 - \tau_1) = 0$. Whence, we know that

$$0 = \tilde{D}_{X_1}((f \cdot (\tau_2 - \tau_1))) = X_1(f)(\tau_2 - \tau_1) + f(\tilde{D}_{X_1} \tau_2 - \tilde{D}_{X_1} \tau_1).$$

As a consequence, we get that $(\tilde{D}_{X_1} \tau_1)|_V = (\tilde{D}_{X_1} \tau_2)|_V$, particularly, $(\tilde{D}_{X_1} \tau_1)|_p = (\tilde{D}_{X_1} \tau_2)|_p$. For the arbitrary choice of p , we get that $(\tilde{D}_{X_1} \tau_1)|_U = (\tilde{D}_{X_1} \tau_2)|_U$ finally.

The local property of \tilde{D} enables us to find an induced connection $\tilde{D}^U : \mathcal{X}(U) \times T_s^r(U) \rightarrow T_s^r(U)$ such that $\tilde{D}_{X|_U}^U(\tau|_U) = (\tilde{D}_X \tau)|_U$ for $\forall X \in \mathcal{X}(\tilde{M})$ and $\tau \in T_s^r \tilde{M}$. Now for $\forall X_1, X_2 \in \mathcal{X}(\tilde{M})$, $\forall \tau_1, \tau_2 \in T_s^r(\tilde{M})$ with $X_1|_{V_p} = X_2|_{V_p}$ and $\tau_1|_{V_p} = \tau_2|_{V_p}$, define a mapping $\tilde{D}^U : \mathcal{X}(U) \times T_s^r(U) \rightarrow T_s^r(U)$ by

$$(\tilde{D}_{X_1}\tau_1)|_{V_p} = (\tilde{D}_{X_1}\tau_2)|_{V_p}$$

for any point $p \in U$. Then since \tilde{D} is a connection on \tilde{M} , it can be checked easily that \tilde{D}^U satisfies all conditions in Definition 3.8. Whence, \tilde{D}^U is indeed a connection on U .

Now we calculate the local form on a chart $(U_p, [\varphi_p])$ of p . Since

$$\tilde{D}_{\frac{\partial}{\partial x^{\mu\nu}}} = \Gamma_{(\sigma\varsigma)(\mu\nu)}^{\kappa\lambda} \frac{\partial}{\partial x^{\sigma\varsigma}},$$

it can find immediately that

$$\tilde{D}_{\frac{\partial}{\partial x^{\mu\nu}}} dx^{\kappa\lambda} = -\Gamma_{(\sigma\varsigma)(\mu\nu)}^{\kappa\lambda} dx^{\sigma\varsigma}$$

by Definition 3.8. Therefore, we find that

$$(\tilde{D}_X\tau)|_U = X^{\sigma\varsigma} \tau_{(\kappa_1\lambda_1)(\kappa_2\lambda_2)\cdots(\kappa_s\lambda_s),(\mu\nu)}^{(\mu_1\nu_1)(\mu_2\nu_2)\cdots(\mu_r\nu_r)} \frac{\partial}{\partial x^{\mu_1\nu_1}} \otimes \cdots \otimes \frac{\partial}{\partial x^{\mu_r\nu_r}} \otimes dx^{\kappa_1\lambda_1} \otimes \cdots \otimes dx^{\kappa_s\lambda_s}$$

with

$$\begin{aligned} \tau_{(\kappa_1\lambda_1)(\kappa_2\lambda_2)\cdots(\kappa_s\lambda_s),(\mu\nu)}^{(\mu_1\nu_1)(\mu_2\nu_2)\cdots(\mu_r\nu_r)} &= \frac{\partial \tau_{(\kappa_1\lambda_1)(\kappa_2\lambda_2)\cdots(\kappa_s\lambda_s)}^{(\mu_1\nu_1)(\mu_2\nu_2)\cdots(\mu_r\nu_r)}}{\partial x^{\mu\nu}} \\ &+ \sum_{a=1}^r \tau_{(\kappa_1\lambda_1)(\kappa_2\lambda_2)\cdots(\kappa_s\lambda_s)}^{(\mu_1\nu_1)\cdots(\mu_{a-1}\nu_{a-1})(\sigma\varsigma)(\mu_{a+1}\nu_{a+1})\cdots(\mu_r\nu_r)} \Gamma_{(\sigma\varsigma)(\mu\nu)}^{\mu_a\nu_a} \\ &- \sum_{b=1}^s \tau_{(\kappa_1\lambda_1)\cdots(\kappa_{b-1}\lambda_{b-1})(\mu\nu)(\sigma_{b+1}\varsigma_{b+1})\cdots(\kappa_s\lambda_s)}^{(\mu_1\nu_1)(\mu_2\nu_2)\cdots(\mu_r\nu_r)} \Gamma_{(\sigma_b\varsigma_b)(\mu\nu)}^{\sigma\varsigma}. \end{aligned}$$

This completes the proof. \square

Theorem 3,8 Let \tilde{M} be a smoothly combinatorial manifold with a connection \tilde{D} . Then for $\forall X, Y \in \mathcal{X}(\tilde{M})$,

$$\tilde{T}(X, Y) = \tilde{D}_X Y - \tilde{D}_Y X - [X, Y]$$

is a tensor of type $(1, 2)$ on \tilde{M} .

Proof By definition, it is clear that $\tilde{T} : \mathcal{X}(\tilde{M}) \times \mathcal{X}(\tilde{M}) \rightarrow \mathcal{X}(\tilde{M})$ is antisymmetrical and bilinear. We only need to check it is also linear on each element in $C^\infty(\tilde{M})$ for variables X or Y . In fact, for $\forall f \in C^\infty(\tilde{M})$,

$$\begin{aligned}
\tilde{T}(fX, Y) &= \tilde{D}_{fX}Y - \tilde{D}_Y(fX) - [fX, Y] \\
&= f\tilde{D}_X Y - (Y(f)X + f\tilde{D}_Y X) \\
&\quad - (f[X, Y] - Y(f)X) = f\tilde{T}(X, Y).
\end{aligned}$$

and

$$\tilde{T}(X, fY) = -\tilde{T}(fY, X) = -f\tilde{T}(Y, X) = f\tilde{T}(X, Y). \quad \square$$

Notice that

$$\begin{aligned}
T\left(\frac{\partial}{\partial x^{\mu\nu}}, \frac{\partial}{\partial x^{\sigma\varsigma}}\right) &= \tilde{D}_{\frac{\partial}{\partial x^{\mu\nu}}} \frac{\partial}{\partial x^{\sigma\varsigma}} - \tilde{D}_{\frac{\partial}{\partial x^{\sigma\varsigma}}} \frac{\partial}{\partial x^{\mu\nu}} \\
&= (\Gamma_{(\mu\nu)(\sigma\varsigma)}^{\kappa\lambda} - \Gamma_{(\sigma\varsigma)(\mu\nu)}^{\kappa\lambda}) \frac{\partial}{\partial x^{\kappa\lambda}}
\end{aligned}$$

under a local chart $(U_p; [\varphi_p])$ of a point $p \in \tilde{M}$. If $T(\frac{\partial}{\partial x^{\mu\nu}}, \frac{\partial}{\partial x^{\sigma\varsigma}}) \equiv 0$, we call T *torsion-free*. This enables us getting the next useful result.

Theorem 3.9 *A connection \tilde{D} on tensors of a smoothly combinatorial manifold \tilde{M} is torsion-free if and only if $\Gamma_{(\mu\nu)(\sigma\varsigma)}^{\kappa\lambda} = \Gamma_{(\sigma\varsigma)(\mu\nu)}^{\kappa\lambda}$.*

Now we turn our attention to the case of $s = r = 1$. Similarly, a *combinatorially Riemannian geometry* is defined in the next definition.

Definition 3.9 *Let \tilde{M} be a smoothly combinatorial manifold and $g \in A^2(\tilde{M}) = \bigcup_{p \in \tilde{M}} T_2^0(p, \tilde{M})$. If g is symmetrical and positive, then \tilde{M} is called a combinatorially Riemannian manifold, denoted by (\tilde{M}, g) . In this case, if there is a connection \tilde{D} on (\tilde{M}, g) with equality following hold*

$$Z(g(X, Y)) = g(\tilde{D}_Z Y) + g(X, \tilde{D}_Z Y) \quad (3.4)$$

then \tilde{M} is called a combinatorially Riemannian geometry, denoted by $(\tilde{M}, g, \tilde{D})$.

We get a result for connections on smoothly combinatorial manifolds similar to that of Riemannian geometry.

Theorem 3.10 *Let (\tilde{M}, g) be a combinatorially Riemannian manifold. Then there exists a unique connection \tilde{D} on (\tilde{M}, g) such that $(\tilde{M}, g, \tilde{D})$ is a combinatorially Riemannian geometry.*

Proof By definition, we know that

$$\tilde{D}_Z g(X, Y) = Z(g(X, Y)) - g(\tilde{D}_Z X, Y) - g(X, \tilde{D}_Z Y)$$

for a connection \tilde{D} on tensors of \tilde{M} and $\forall Z \in \mathcal{X}(\tilde{M})$. Thereby, the equality (3.4) is equivalent to that of $\tilde{D}_Z g = 0$ for $\forall Z \in \mathcal{X}(\tilde{M})$, namely \tilde{D} is torsion-free.

Not loss of generality, assume $g = g_{(\mu\nu)(\sigma\varsigma)} dx^{\mu\nu} dx^{\sigma\varsigma}$ in a local chart $(U_p; [\varphi_p])$ of a point p , where $g_{(\mu\nu)(\sigma\varsigma)} = g(\frac{\partial}{\partial x^{\mu\nu}}, \frac{\partial}{\partial x^{\sigma\varsigma}})$. Then we find that

$$\tilde{D}g = \left(\frac{\partial g_{(\mu\nu)(\sigma\varsigma)}}{\partial x^{\kappa\lambda}} - g_{(\zeta\eta)(\sigma\varsigma)} \Gamma_{(\mu\nu)(\sigma\varsigma)}^{\zeta\eta} - g_{(\mu\nu)(\zeta\eta)} \Gamma_{(\sigma\varsigma)(\kappa\lambda)}^{\zeta\eta} \right) dx^{\mu\nu} \otimes dx^{\sigma\varsigma} \otimes dx^{\kappa\lambda}.$$

Therefore, we get that

$$\frac{\partial g_{(\mu\nu)(\sigma\varsigma)}}{\partial x^{\kappa\lambda}} = g_{(\zeta\eta)(\sigma\varsigma)} \Gamma_{(\mu\nu)(\sigma\varsigma)}^{\zeta\eta} + g_{(\mu\nu)(\zeta\eta)} \Gamma_{(\sigma\varsigma)(\kappa\lambda)}^{\zeta\eta} \quad (3.5)$$

if $\tilde{D}_Z g = 0$ for $\forall Z \in \mathcal{X}(\tilde{M})$. The formula (3.5) enables us to get that

$$\Gamma_{(\mu\nu)(\sigma\varsigma)}^{\kappa\lambda} = \frac{1}{2} g^{(\kappa\lambda)(\zeta\eta)} \left(\frac{\partial g_{(\mu\nu)(\zeta\eta)}}{\partial x^{\sigma\varsigma}} + \frac{\partial g_{(\zeta\eta)(\sigma\varsigma)}}{\partial x^{\mu\nu}} - \frac{\partial g_{(\mu\nu)(\sigma\varsigma)}}{\partial x^{\zeta\eta}} \right),$$

where $g^{(\kappa\lambda)(\zeta\eta)}$ is an element in the matrix inverse of $[g_{(\mu\nu)(\sigma\varsigma)}]$.

Now if there exists another torsion-free connection \tilde{D}^* on (\tilde{M}, g) with

$$\tilde{D}^*_{\frac{\partial}{\partial x^{\mu\nu}}} = \Gamma_{(\sigma\varsigma)(\mu\nu)}^{*\kappa\lambda} \frac{\partial}{\partial x^{\kappa\lambda}},$$

then we must get that

$$\Gamma_{(\mu\nu)(\sigma\varsigma)}^{*\kappa\lambda} = \frac{1}{2} g^{(\kappa\lambda)(\zeta\eta)} \left(\frac{\partial g_{(\mu\nu)(\zeta\eta)}}{\partial x^{\sigma\varsigma}} + \frac{\partial g_{(\zeta\eta)(\sigma\varsigma)}}{\partial x^{\mu\nu}} - \frac{\partial g_{(\mu\nu)(\sigma\varsigma)}}{\partial x^{\zeta\eta}} \right).$$

Accordingly, $\tilde{D} = \tilde{D}^*$. Whence, there are at most one torsion-free connection \tilde{D} on a combinatorially Riemannian manifold (\tilde{M}, g) .

For the existence of torsion-free connection \tilde{D} on (\tilde{M}, g) , let $\Gamma_{(\mu\nu)(\sigma\varsigma)}^{\kappa\lambda} = \Gamma_{(\sigma\varsigma)(\mu\nu)}^{\kappa\lambda}$ and define a connection \tilde{D} on (\tilde{M}, g) such that

$$\tilde{D}_{\frac{\partial}{\partial x^{\mu\nu}}} = \Gamma_{(\sigma\varsigma)(\mu\nu)}^{\kappa\lambda} \frac{\partial}{\partial x^{\kappa\lambda}},$$

then \tilde{D} is torsion-free by Theorem 3.9. This completes the proof. \square

Corollary 3.3([2]) *For a Riemannian manifold (M, g) , there exists only one torsion-free connection D , i.e.,*

$$D_Z g(X, Y) = Z(g(X, Y)) - g(D_Z X, Y) - g(X, D_Z Y) \equiv 0$$

for $\forall X, Y, Z \in \mathcal{X}(M)$.

3.4 Minkowski Norms

These *Minkowski norms* are the fundamental in Finsler geometry. Certainly, they can be also generalized on smoothly combinatorial manifolds.

Definition 3.10 *A Minkowski norm on a vector space V is a function $F : V \rightarrow \mathbf{R}$ such that*

- (1) F is smooth on $V \setminus \{0\}$ and $F(v) \geq 0$ for $\forall v \in V$;
- (2) F is 1-homogenous, i.e., $F(\lambda v) = \lambda F(v)$ for $\forall \lambda > 0$;
- (3) for all $y \in V \setminus \{0\}$, the symmetric bilinear form $g_y : V \times V \rightarrow \mathbf{R}$ with

$$g_y(u, v) = \sum_{i,j} \frac{\partial^2 F(y)}{\partial y^i \partial y^j}$$

is positive definite for $u, v \in V$.

Denoted by $T\widetilde{M} = \bigcup_{p \in \widetilde{M}} T_p \widetilde{M}$. Similar to Finsler geometry, we introduce combinatorially Finsler geometries on a Minkowski norm defined on $T\widetilde{M}$.

Definition 3.11 *A combinatorially Finsler geometry is a smoothly combinatorial manifold \widetilde{M} endowed with a Minkowski norm \widetilde{F} on $T\widetilde{M}$, denoted by $(\widetilde{M}; \widetilde{F})$.*

Then we get the following result.

Theorem 3.11 *There are combinatorially Finsler geometries.*

Proof Let $\widetilde{M}(n_1, n_2, \dots, n_m)$ be a smoothly combinatorial manifold. Construct Minkowski norms on $T\widetilde{M}(n_1, n_2, \dots, n_m)$. Let $\mathbf{R}^{n_1+n_2+\dots+n_m}$ be an euclidean space. Then there exists a Minkowski norm $F(\overline{x}) = |\overline{x}|$ in $\mathbf{R}^{n_1+n_2+\dots+n_m}$ at least, in here $|\overline{x}|$ denotes the euclidean norm on $\mathbf{R}^{n_1+n_2+\dots+n_m}$. According to Theorem 3.2, $T_p \widetilde{M}(n_1, n_2, \dots, n_m)$ is homeomorphic to $\mathbf{R}^{\widehat{s}(p)-s(p)\widehat{s}(p)+n_{i_1}+\dots+n_{i_{s(p)}}$. Whence there are Minkowski norms on $T_p \widetilde{M}(n_1, n_2, \dots, n_m)$ for $p \in U_p$, where $(U_p; [\varphi_p])$ is a local chart.

Notice that the number of manifolds are finite in a smoothly combinatorial manifold $\widetilde{M}(n_1, n_2, \dots, n_m)$ and each manifold has a finite cover $\{(U_\alpha; \varphi_\alpha) | \alpha \in I\}$, where I is a finite index set. We know that there is a finite cover

$$\bigcup_{M \in V(G[\widetilde{M}(n_1, n_2, \dots, n_m)])} \{(U_{M\alpha}; \varphi_{M\alpha}) | \alpha \in I_M\}.$$

By the decomposition theorem for unit, we know that there are smooth functions $h_{M\alpha}, \alpha \in I_M$ such that

$$\sum_{M \in V(G[\widetilde{M}(n_1, n_2, \dots, n_m)])} \sum_{\alpha \in I_M} h_{M\alpha} = 1 \text{ with } 0 \leq h_{M\alpha} \leq 1.$$

Now we choose a Minkowski norm $\widetilde{F}^{M\alpha}$ on $T_p M_\alpha$ for $\forall p \in U_{M\alpha}$. Define

$$\widetilde{F}_{M\alpha} = \begin{cases} h^{M\alpha} \widetilde{F}^{M\alpha}, & \text{if } p \in U_{M\alpha}, \\ 0, & \text{if } p \notin U_{M\alpha} \end{cases}$$

for $\forall p \in \widetilde{M}$. Now let

$$\widetilde{F} = \sum_{M \in V(G[\widetilde{M}(n_1, n_2, \dots, n_m)])} \sum_{\alpha \in I} \widetilde{F}_{M\alpha}.$$

Then \widetilde{F} is a Minkowski norm on $T\widetilde{M}(n_1, n_2, \dots, n_m)$ since it can be checked immediately that all conditions (1) – (3) in Definition 3.10 hold. \square

For the relation of combinatorially Finsler geometries with these Smarandache geometries, we obtain the next consequence.

Theorem 3.12 *A combinatorially Finsler geometry $(\widetilde{M}(n_1, n_2, \dots, n_m); \widetilde{F})$ is a Smarandache geometry if $m \geq 2$.*

Proof Notice that if $m \geq 2$, then $\widetilde{M}(n_1, n_2, \dots, n_m)$ is combined by at least two manifolds M^{n_1} and M^{n_2} with $n_1 \neq n_2$. By definition, we know that

$$M^{n_1} \setminus M^{n_2} \neq \emptyset \text{ and } M^{n_2} \setminus M^{n_1} \neq \emptyset.$$

Now the axiom *there is an integer n such that there exists a neighborhood homeomorphic to a open ball B^n for any point in this space* is Smarandachely denied, since for points in $M^{n_1} \setminus M^{n_2}$, each has a neighborhood homeomorphic to B^{n_1} , but each point in $M^{n_2} \setminus M^{n_1}$ has a neighborhood homeomorphic to B^{n_2} . \square

Theorems 3.11 and 3.12 imply inclusions in Smarandache geometries for classical geometries in the following.

Corollary 3.5 *There are inclusions among Smarandache geometries, Finsler geometry, Riemannian geometry and Weyl geometry.*

$$\begin{aligned} & \{\text{Smarandache geometries}\} \supset \{\text{combinatorially Finsler geometries}\} \\ & \supset \{\text{Finsler geometry}\} \text{ and } \{\text{combinatorially Riemannian geometries}\} \\ & \supset \{\text{Riemannian geometry}\} \supset \{\text{Weyl geometry}\}. \end{aligned}$$

Proof Let $m = 1$. Then a combinatorially Finsler geometry $(\widetilde{M}(n_1, n_2, \dots, n_m); \widetilde{F})$ is nothing but just a Finsler geometry. Applying Theorems 3.11 and 3.12 to this special case, we get these inclusions as expected. \square

Corollary 3.6 *There are inclusions among Smarandache geometries, combinatorially Riemannian geometries and Kähler geometry.*

$$\begin{aligned} \{\text{Smarandache geometries}\} & \supset \{\text{combinatorially Riemannian geometries}\} \\ & \supset \{\text{Riemannian geometry}\} \\ & \supset \{\text{Kähler geometry}\}. \end{aligned}$$

Proof Let $m = 1$ in a combinatorial manifold $\widetilde{M}(n_1, n_2, \dots, n_m)$ and applies Theorems 3.10 and 3.12, we get inclusions

$$\begin{aligned} \{\text{Smarandache geometries}\} & \supset \{\text{combinatorially Riemannian geometries}\} \\ & \supset \{\text{Riemannian geometry}\}. \end{aligned}$$

For the Kähler geometry, notice that any complex manifold M_c^n is equal to a smoothly real manifold M^{2n} with a natural base $\{\frac{\partial}{\partial x^i}, \frac{\partial}{\partial y^i}\}$ for $T_p M_c^n$ at each point $p \in M_c^n$. Whence, we get

$$\{\text{Riemannian geometry}\} \supset \{\text{Kähler geometry}\}. \quad \square$$

§4. Further Discussions

4.1 Embedding problems Whitney had shown that *any smooth manifold M^d can be embedded as a closed submanifold of \mathbf{R}^{2d+1}* in 1936 ([1]). The same embedding

problem for finitely combinatorial manifold in an euclidean space is also interesting. Since \widetilde{M} is finite, by applying Whitney theorem, we know that there is an integer $n(\widetilde{M}), n(\widetilde{M}) < +\infty$ such that \widetilde{M} can be embedded as a closed submanifold in $\mathbf{R}^{n(\widetilde{M})}$. Then *what is the minimum dimension of euclidean spaces embeddable a given finitely combinatorial manifold \widetilde{M} ? Wether can we determine it for some combinatorial manifolds with a given graph structure, such as those of complete graphs K^n , circuits P^n or cubic graphs Q^n ?*

Conjecture 4.1 *The minimum dimension of euclidean spaces embeddable a finitely combinatorial manifold \widetilde{M} is*

$$2 \min_{p \in \widetilde{M}} \{ \widehat{s}(p) - s(p)\widehat{s}(p) + n_{i_1} + n_{i_2} + \cdots + n_{i_{s(p)}} \} + 1.$$

4.2 D-dimensional holes For these closed 2-manifolds S , it is well-known that

$$\chi(S) = \begin{cases} 2 - 2p(S), & \text{if } S \text{ is orientable,} \\ 2 - q(S). & \text{if } S \text{ is non-orientable.} \end{cases}$$

with $p(S)$ or $q(S)$ the orientable genus or non-orientable genus of S , namely 2-dimensional holes adjacent to S . For general case of n -manifolds M , we know that

$$\chi(M) = \sum_{k=0}^{\infty} (-1)^k \dim H_k(M),$$

where $\dim H_k(M)$ is the rank of these k -dimensional homology groups $H_k(M)$ in M , namely the number of k -dimensional holes adjacent to the manifold M . By the definition of combinatorial manifolds, some k -dimensional holes adjacent to a combinatorial manifold are increased. Then *what is the relation between the Euler-Poincare characteristic of a combinatorial manifold \widetilde{M} and the i -dimensional holes adjacent to \widetilde{M} ? Wether can we find a formula likewise the Euler-Poincare formula?* Calculation shows that even for the case of $n = 2$, the situation is complex. For example, choose n different orientable 2-manifolds S_1, S_2, \cdots, S_n and let them intersects one after another at n different points in \mathbf{R}^3 . We get a combinatorial manifold \widetilde{M} . Calculation shows that

$$\chi(\widetilde{M}) = (\chi(S_1) + \chi(S_2) + \cdots + \chi(S_n)) - n$$

by Theorem 2.9. But it only increases one 2-holes. *What is the relation of 2-dimensional holes adjacent to \widetilde{M} ?*

4.3 Local properties Although a finitely combinatorial manifold \widetilde{M} is not homogenous in general, namely the dimension of local charts of two points in \widetilde{M} maybe different, we have still constructed global operators such as those of exterior differentiation \widetilde{d} and connection \widetilde{D} on $T_s^r \widetilde{M}$. A operator $\widetilde{\mathcal{D}}$ is said to be *local* on a subset $W \subset T_s^r \widetilde{M}$ if for any local chart $(U_p, [\varphi_p])$ of a point $p \in W$,

$$\widetilde{\mathcal{D}}|_{U_p}(W) = \widetilde{\mathcal{D}}(W)_{U_p}.$$

Of course, nearly all existent operators with local properties on $T_s^r \widetilde{M}$ in Finsler or Riemannian geometries can be reconstructed in these combinatorially Finsler or Riemannian geometries and find the local forms similar to those in Finsler or Riemannian geometries.

4.4 Global properties To find global properties on manifolds is a central task in classical differential geometry. The same is true for combinatorial manifolds. In classical geometry on manifolds, some global results, such as those of *de Rham* theorem and *Atiyah-Singer* index theorem,..., etc. are well-known. Remember that the p^{th} de Rham cohomology group on a manifold M and the *index* $\text{Ind}\mathcal{D}$ of a *Fredholm* operator $\mathcal{D} : H^k(M, E) \rightarrow L^2(M, F)$ are defined to be a quotient space

$$H^p(M) = \frac{\text{Ker}(d : \Lambda^p(M) \rightarrow \Lambda^{p+1}(M))}{\text{Im}(d : \Lambda^{p-1}(M) \rightarrow \Lambda^p(M))}$$

and an integer

$$\text{Ind}\mathcal{D} = \dim \text{Ker}(\mathcal{D}) - \dim\left(\frac{L^2(M, F)}{\text{Im}\mathcal{D}}\right)$$

respectively. The de Rham theorem and the Atiyah-Singer index theorem respectively conclude that

for any manifold M , a mapping $\varphi : \Lambda^p(M) \rightarrow \text{Hom}(\Pi_p(M), \mathbf{R})$ induces a natural isomorphism $\varphi^ : H^p(M) \rightarrow H^n(M; \mathbf{R})$ of cohomology groups, where $\Pi_p(M)$ is the free Abelian group generated by the set of all p -simplexes in M*

and

$$\text{Ind}\mathcal{D} = \text{Ind}_T(\sigma(\mathcal{D})),$$

where $\sigma(\mathcal{D}) : T^*M \rightarrow \text{Hom}(E, F)$ and $\text{Ind}_T(\sigma(\mathcal{D}))$ is the topological index of $\sigma(\mathcal{D})$. Now the questions for these finitely combinatorial manifolds are given in the following.

- (1) *Is the de Rham theorem and Atiyah-Singer index theorem still true for finitely combinatorial manifolds? If not, what is its modified forms?*
- (2) *Check other global results for manifolds whether true or get their new modified forms for finitely combinatorial manifolds.*

References

- [1] R.Abraham and Marsden, *Foundation of Mechanics*(2nd edition), Addison-Wesley, Reading, Mass, 1978.
- [2] W.H.Chern and X.X.Li, *Introduction to Riemannian Geometry*, Peking University Press, 2002.
- [3] H.Iseri, *Smarandache manifolds*, American Research Press, Rehoboth, NM,2002.
- [4] L.Kuciuk and M.Antholy, An Introduction to Smarandache Geometries, *JP Journal of Geometry and Topology*, 5(1), 2005,77-81.
- [5] L.F.Mao, *Automorphism Groups of Maps, Surfaces and Smarandache Geometries*, American Research Press, 2005.
- [6] L.F.Mao, *On Automorphisms groups of Maps, Surfaces and Smarandache geometries*, *Scientia Magna*, Vol.1(2005), No.2, 55-73.
- [7] L.F.Mao, *Smarandache multi-space theory*, Hexis, Phoenix, AZ, 2006.
- [8] L.F.Mao, On multi-metric spaces, *Scientia Magna*, Vol.2,No.1(2006), 87-94.
- [9] L.F.Mao, On algebraic multi-group spaces, *Scientia Magna*, Vol.2,No.1(2006), 64-70.
- [10] L.F.Mao, On algebraic multi-ring spaces, *Scientia Magna*, Vol.2,No.2(2006), 48-54.
- [11] L.F.Mao, On algebraic multi-vector spaces, *Scientia Magna*, Vol.2,No.2(2006), 1-6.
- [12] L.F.Mao, Pseudo-Manifold Geometries with Applications, *International J.Mathematical Combinatorics*, Vol.1,No.1, 45-58.
- [13] L.F.Mao, A new view of combinatorial maps by Smarandache's notion, *Selected Papers on Mathematical Combinatorics*(I), 49-74, World Academic Union, 2006.
- [14] W.S.Massey, *Algebraic topology: an introduction*, Springer-Verlag,New York, etc.(1977).
- [15] V.V.Nikulin and I.R.Shafarevich, *Geometries and Groups*, Springer-Verlag Berlin Heidelberg (1987)
- [16] Joseph J.Rotman, *An introduction to algebraic topology*, Springer-Verlag New York Inc. 1988.

- [17] F.Smarandache, Mixed noneuclidean geometries, *eprint arXiv: math/0010119*, 10/2000.
- [18] J.Stillwell, *Classical topology and combinatorial group theory*, Springer-Verlag New York Inc., (1980).

The *Scientific Elements* is an international book series, maybe with different subtitles. This series is devoted to the applications of Smarandache's notions and to mathematical combinatorics. These are two heartening mathematical theories for sciences and can be applied to many fields. This book selects 12 papers for showing applications of Smarandache's notions, such as those of Smarandache multi-spaces, Smarandache geometries, Neutrosophy, etc. to classical mathematics, theoretical and experimental physics, logic, cosmology. Looking at these elementary applications, we can experience their great potential for developing sciences.

12 authors contributed to this volume: Linfan Mao, Yuhua Fu, Shenglin Cao, Jingsong Feng, Changwei Hu, Zhengda Luo, Hao Ji, Xinwei Huang, Yiyang Guan, Tianyu Guan, Shuan Chen, and Yan Zhang.

