

Vol. 21, 2018

# Neutrosophic Sets and Systems

An International Journal in Information Science  
and Engineering

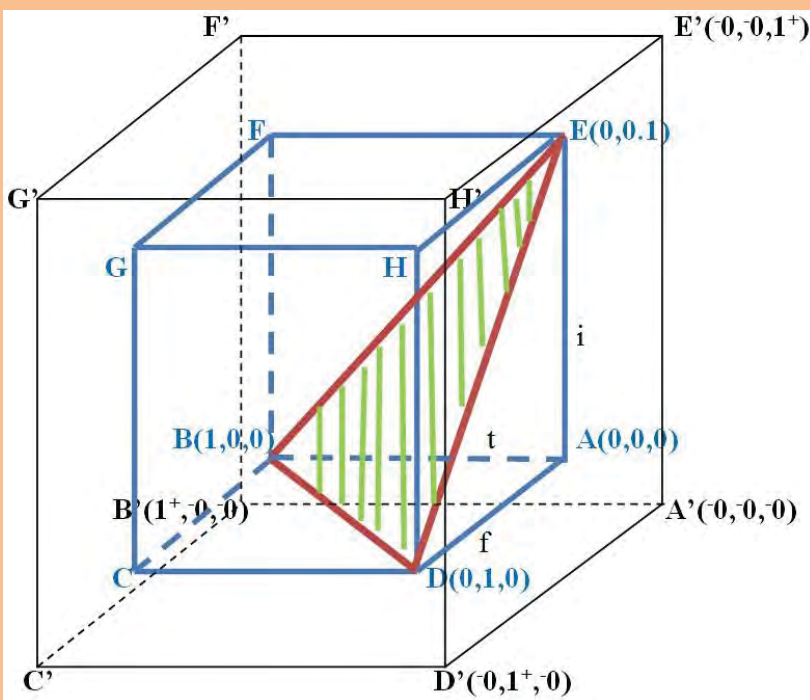

ISSN 2331-6055 (print)

ISSN 2331-608X (online)

# Neutrosophic Sets and Systems

**An International Journal in Information Science and Engineering**



University of New Mexico



# Neutrosophic Sets and Systems

An International Journal in Information Science and Engineering

## Copyright Notice

Copyright @ Neutrosophics Sets and Systems

All rights reserved. The authors of the articles do hereby grant Neutrosophic Sets and Systems non-exclusive, worldwide, royalty-free license to publish and distribute the articles in accordance with the Budapest Open Initiative: this means that electronic copying, distribution and printing of both full-size version of the journal and the individual papers published therein for non-commercial, academic or individual use can be made by any user without permission or charge. The authors of the articles published in Neutrosophic Sets and Systems retain their rights to use this journal as a whole or any part of it in any other publications and in any way they see fit. Any part of Neutrosophic Sets and Systems howsoever used in other publications must include an appropriate citation of this journal.

## Information for Authors and Subscribers

“Neutrosophic Sets and Systems” has been created for publications on advanced studies in neutrosophy, neutrosophic set, neutrosophic logic, neutrosophic probability, neutrosophic statistics that started in 1995 and their applications in any field, such as the neutrosophic structures developed in algebra, geometry, topology, etc.

The submitted papers should be professional, in good English, containing a brief review of a problem and obtained results.

*Neutrosophy* is a new branch of philosophy that studies the origin, nature, and scope of neutralities, as well as their interactions with different ideational spectra.

This theory considers every notion or idea  $\langle A \rangle$  together with its opposite or negation  $\langle \text{anti}A \rangle$  and with their spectrum of neutralities  $\langle \text{neut}A \rangle$  in between them (i.e. notions or ideas supporting neither  $\langle A \rangle$  nor  $\langle \text{anti}A \rangle$ ). The  $\langle \text{neut}A \rangle$  and  $\langle \text{anti}A \rangle$  ideas together are referred to as  $\langle \text{non}A \rangle$ .

Neutrosophy is a generalization of Hegel's dialectics (the last one is based on  $\langle A \rangle$  and  $\langle \text{anti}A \rangle$  only).

According to this theory every idea  $\langle A \rangle$  tends to be neutralized and balanced by  $\langle \text{anti}A \rangle$  and  $\langle \text{non}A \rangle$  ideas - as a state of equilibrium.

In a classical way  $\langle A \rangle$ ,  $\langle \text{neut}A \rangle$ ,  $\langle \text{anti}A \rangle$  are disjoint two by two. But, since in many cases the borders between notions are vague, imprecise, Sorites, it is possible that  $\langle A \rangle$ ,  $\langle \text{neut}A \rangle$ ,  $\langle \text{anti}A \rangle$  (and  $\langle \text{non}A \rangle$  of course) have common parts two by two, or even all three of them as well.

*Neutrosophic Set* and *Neutrosophic Logic* are generalizations of the fuzzy set and respectively fuzzy logic (especially of intuitionistic fuzzy set and respectively intuitionistic fuzzy logic). In neutrosophic logic a proposition has a degree of truth ( $T$ ), a degree of indeterminacy ( $I$ ), and a degree of falsity ( $F$ ), where  $T, I, F$  are standard or non-standard subsets of  $]0, 1+[$ .

*Neutrosophic Probability* is a generalization of the classical probability and imprecise probability.

*Neutrosophic Statistics* is a generalization of the classical statistics.

What distinguishes the neutrosophics from other fields is the  $\langle \text{neut}A \rangle$ , which means neither  $\langle A \rangle$  nor  $\langle \text{anti}A \rangle$ .

$\langle \text{neut}A \rangle$ , which of course depends on  $\langle A \rangle$ , can be indeterminacy, neutrality, tie game, unknown, contradiction, ignorance, imprecision, etc.

All submissions should be designed in MS Word format using our template file:

<http://fs.unm.edu/NSS/NSS-paper-template.doc>.

A variety of scientific books in many languages can be downloaded freely from the Digital Library of Science:

<http://fs.unm.edu/ScienceLibrary.htm>.

To submit a paper, mail the file to the Editor-in-Chief. To order printed issues, contact the Editor-in-Chief. This journal is non-commercial, academic edition. It is printed from private donations.

Information about the neutrosophics you get from the UNM website:

<http://fs.unm.edu/neutrosophy.htm>.

The home page of the journal is accessed on

<http://fs.unm.edu/NSS>.



## Contents

T. Chalapathi, R. V. Kiran Kumar. <b>Neutrosophic Units of Neutrosophic Rings and Fields</b> .....	5
A. A. Salama, Florentin Smarandache, Hewayda ElGhawalby. <b>Neutrosophic Approach to Grayscale Images Domain</b> .....	13
Mehmet Şahin, Abdullah Kargin. <b>Neutrosophic Triplet Normed Ring Space</b> .....	20
Riad K. Al-Hamido, Qays Hatem Imran, Kareem A. Alghurabi, T. Gharibah. <b>On Neutrosophic Crisp Semi Alpha Closed Sets</b> .....	28
Suriana Alias, Daud Mohamad, Adibah Shuib. <b>Rough Neutrosophic Multisets Relation with Application in Marketing Strategy</b> .....	36
Fatimah M. Mohammed, Shaymaa F. Matar. <b>Fuzzy Neutrosophic Alpha<sup>m</sup>-Closed Sets in Fuzzy Neutrosophic Topological Spaces</b> .....	56
Riad K. Al-Hamido. <b>Neutrosophic Crisp Bi-Topological Spaces</b> .....	66
Sahidul Islam, Partha Ray. <b>Multi-Objective Portfolio Selection Model with Diversification by Neutrosophic Optimization Technique</b> .....	74
Ramona Parraga Alava, José Muñoz Murillo, Roy Barre Zambrano, María Isabel Zambrano Vélez, Maikel Leyva Vázquez. <b>PEST Analysis Based on Neutrosophic Cognitive Maps: A Case Study for Food Industry</b> .....	84
Chaitali Kar, Bappa Mondal, T. K. Roy. <b>An Inventory Model under Space Constraint in Neutrosophic Environment: A Neutrosophic Geometric Programming Approach</b> .....	93
Surapati Pramanik, Partha Pratim Dey. <b>Bi-level Linear Programming Problem with Neutrosophic Numbers</b> .....	110
Milton Villegas Alava, Stella Paola Delgado Figueroa, Hilda Mercedes Blum Alcivar, Maikel Leyva Vázquez. <b>Single Valued Neutrosophic Numbers and Analytic Hierarchy Process for Project Selection</b> .....	122
Shyamal Dalapati, Surapati Pramanik. <b>A Revisit to NC-VIKOR Based MAGDM Strategy in Neutrosophic Cubic Set Environment</b> .....	131
Nguyen Xuan Thao, Florentin Smarandache. <b>Divergence measure of neutrosophic sets and applications</b> .....	142
Florentin Smarandache. <b>Plithogenic Set, an Extension of Crisp, Fuzzy, Intuitionistic Fuzzy, and Neutrosophic Sets – Revisited</b> .....	153



## Editors-in-Chief

Prof. Florentin Smarandache, PhD, Postdoc, Mathematics Department, University of New Mexico, Gallup, NM 87301, USA, Email: smarand@unm.edu.

Dr. Surapati Pramanik, Nandalal Ghosh B.T. College, Panpur, Narayanpur, Dist-North 24 Parganas, West Bengal, India-743126, Email: sura\_pati@yahoo.co.in.

## Associate Editors

Said Broumi, University of Hassan II, Casablanca, Morocco, Email: broumisaid78@gmail.com.

Mohamed Abdel-Baset, Faculty of Computers and Informatics, Zagazig University, Egypt, Email: analyst\_mohamed@yahoo.com.

Prof. Le Hoang Son, VNU Univ. of Science, Vietnam National Univ. Hanoi, Vietnam, Email: sonlh@vnu.edu.vn.

Huda E. Khalid, University of Telafer, College of Basic Education, Telafer - Mosul, Iraq, Email: hodaesmail@yahoo.com.

Dr. Mumtaz Ali, University of Southern Queensland, Australia, Email: bloomy\_boy2006@yahoo.com.

Prof. Xiaohong Zhang, Department of Mathematics, Shaanxi University of Science & Technology, Xian 710021, China, Email: zhangxh@shmtu.edu.cn.

## Editors

W. B. Vasantha Kandasamy, Indian Institute of Technology, Chennai, Tamil Nadu, India, Email: vasanthakandasamy@gmail.com.

A. A. Salama, Faculty of Science, Port Said University, Egypt, Email: drsalama44@gmail.com.

Yanhui Guo, University of Illinois at Springfield, One University Plaza, Springfield, IL 62703, USA, Email: yguo56@uis.edu.

Young Bae Jun, Gyeongsang National University, South Korea, Email: skywine@gmail.com.

F. Gallego Lupianez, Universidad Complutense, Madrid, Spain, Email: fg\_lupianez@mat.ucm.es.

Vakkas Ulucay, Gaziantep University, Gaziantep, Turkey, Email: vulucay27@gmail.com.

Peide Liu, Shandong University of Finance and Economics, China, Email: peide.liu@gmail.com.

Pabitra Kumar Maji, Math Department, K. N. University, India, Email: pabitra\_maji@yahoo.com.

S. A. Albolwi, King Abdulaziz Univ., Jeddah, Saudi Arabia, Email: salwaalbolwi@hotmail.com.

Jun Ye, Shaoxing University, China, Email: yehjun@aliyun.com.

Madad Khan, Comsats Institute of Information Technology, Abbottabad, Pakistan, Email: madadmath@yahoo.com.

Stefan Vladutescu, University of Craiova, Romania, Email: stefan.vladutescu@yahoo.com.

Valeri Kroumov, Okayama University of Science, Japan, Email: val@ee.ous.ac.jp.

Dmitri Rabounski and Larissa Borissova, independent researchers, Email: rabounski@ptep-online.com, Email: lborissova@yahoo.com.

Selcuk Topal, Mathematics Department, Bitlis Eren University, Turkey, Email: s.topal@beu.edu.tr.

Luige Vladareanu, Romanian Academy, Bucharest, Romania, Email: luigiv@arexim.ro.

Ibrahim El-henawy, Faculty of Computers and Informatics, Zagazig University, Egypt, Email: henawy2000@yahoo.com.

A. A. A. Agboola, Federal University of Agriculture, Abeokuta, Nigeria, Email: aaaola2003@yahoo.com.

Luu Quoc Dat, Univ. of Economics and Business, Vietnam National Univ., Hanoi, Vietnam, Email: datlq@vnu.edu.vn.

Maikel Leyva-Vazquez, Universidad de Guayaquil, Ecuador, Email: mleyvaz@gmail.com.

Muhammad Akram, University of the Punjab, New Campus, Lahore, Pakistan, Email: m.akram@puccit.edu.pk.

Irfan Deli, Muallim Rifat Faculty of Education, Kilis 7 Aralik University, Turkey, Email: irfandeli@kilis.edu.tr.

Ridvan Sahin, Department of Mathematics, Faculty of Science, Ataturk University, Erzurum 25240, Turkey, Email: mat.ridone@gmail.com.

Ibrahim M. Hezam, Department of computer, Faculty of Education, Ibb University, Ibb City, Yemen, Email: ibrahimzam.math@gmail.com.

Pingping Chi, China-Asean International College, Dhurakij Pun-

dit University, Bangkok 10210, Thailand, Email: chipingping@126.com.

Ameirys Betancourt-Vázquez, 1 Instituto Superior Politécnico de Tecnologías e Ciências (ISPTEC), Luanda, Angola, E-mail: ameirysbv@gmail.com.

Karina Pérez-Teruel, Universidad Abierta para Adultos (UAPA), Santiago de los Caballeros, República Dominicana, E-mail: karinapt@gmail.com.

Neilys González Benítez, Centro Meteorológico Pinar del Río, Cuba, E-mail: neilys71@nauta.cu.

B. Davvaz, Department of Mathematics, Yazd University, Iran, Email: davvaz@yazd.ac.ir.

Victor Christianto, Malang Institute of Agriculture (IPM), Malang, Indonesia, Email: victorchristianto@gmail.com.

Wadei Al-Omeri, Department of Mathematics, Al-Balqa Applied University, Salt 19117, Jordan, Email: wadeialomeri@bau.edu.jo, wadeimoon1@hotmail.com.

Ganeshsree Selvachandran, UCSI University, Jalan Menara Gading, Kuala Lumpur, Malaysia, Email: ganeshsree86@yahoo.com.

Saeid Jafari, College of Vestsjælland South, Slagelse, Denmark, Email: jafariipersia@gmail.com.

Arun Kumar Sangaiah, VIT University, Vellore, India, Email: arunkumarsangaiah@gmail.com.

Kul Hur, Wonkwang University, Iksan, Jeollabukdo, South Korea, Email: kulhur@wonkwang.ac.kr.

Darjan Karabasevic, University Business Academy, Novi Sad, Serbia, Email: darjan.karabasevic@mef.edu.rs.

Kemal Veliyeva & Sadi Bayramov, Department of Algebra and Geometry, Baku State University, 23 Z. Khalilov Str., AZ1148, Baku, Azerbaijan, Email: kemal2607@mail.ru, Email: baysadi@gmail.com.

Dragisa Stanujkic, John Naisbitt University, Belgrade, Serbia, Email: dstanujkic@tfbor.bg.ac.rs.

E. K. Zavadskas, Vilnius Gediminas Technical University, Vilnius, Lithuania, Email: edmundas.zavadskas@vgtu.lt.

Inayat Rehman, College of Arts and Applied Sciences, Dhofar University Salalah, Oman, Email: inayat@yahoo.com.

Riad K. Al-Hamido, Math Department, College of Science, Al-Baath University, Homs, Syria, Email: riadh-amido1983@hotmail.com.

Suriana Alias, Universiti Teknologi MARA (UiTM) Kelantan, Campus Machang, 18500 Machang, Kelantan, Malaysia, Email: suria588@kelantan.uitm.edu.my.

M. Ganster, Graz University of Technology, Graz, Austria, Email: ganster@weyl.math.tu-graz.ac.at.

Willem K. M. Brauers, Faculty of Applied Economics, University of Antwerp, Antwerp, Belgium, Email: willem.brauers@ua.ac.be.

Philippe Schweizer, Independent Researcher, Av. de Lonay 11, 1110 Morges, Switzerland, Email: flippe2@gmail.com.

Angelo de Oliveira, Ciencia da Computacao, Universidade Federal de Rondonia, Porto Velho - Rondonia, Brasil, Email: angeo@unir.br.



# Neutrosophic Units of Neutrosophic Rings and Fields

T. Chalapathi<sup>1</sup>, and R. V. M. S. S. Kiran Kumar<sup>2</sup>

<sup>1</sup>Department of Mathematics, Sree Vidyanikethan Eng.College Tirupati,-517502, Andhra Pradesh, India.

E-mail: chalapathi.tekuri@gmail.com.

<sup>2</sup>Research Scholar, Department of Mathematics, S.V.University, Tirupati,-517502, Andhra Pradesh, India.

E-mail: [kksaisiva@gmail.com](mailto:kksaisiva@gmail.com).

**Abstract.** Let  $N(R, I)$  be a commutative Neutrosophic ring with unity. Then the set of all Neutrosophic group units of  $N(R, I)$  is denoted by  $N(R^\times, I)$ . In this paper, we studied concrete properties of  $N(R^\times, I)$  and presented some standard examples with construction of different illustrations and also examine properties of  $N(R^\times, I)$  satisfied by certain general collections of classical rings and fields. Further, we proved an important result  $N(Z_m^\times \times Z_n^\times, I) \cong N(Z_m^\times, I) \times N(Z_n^\times, I)$  for all positive integers  $m$  and  $n$ .

**Keywords:** Classical ring, group units, Neutrosophic ring, Neutrosophic units, Neutrosophic isomorphism.

## 1. Introduction

In recent years, the inter connection between classical structures and Neutrosophic structures is studied by few researchers. For such kind of study, researchers defined new algebraic structures whose elements are generated by elements in classical algebraic set and indeterminate of the real world problem with respect to algebraic operations on the well defined Neutrosophic elements.

The idea of associating a Neutrosophic structure to a classical structure first appears in [1, 2]. For the elements of the Neutrosophic set, Vasantha Kandasamy and Smarandache takes all elements of a classical ring  $R$  together with indeterminate  $I$ . The notion  $N(R, I)$  of Neutrosophic ring was introduced by Vasantha Kandasamy and Smarandache in 2006 and the Neutrosophic element in  $N(R, I)$  is denoted by  $a + bI$  if for all  $a, b \in R$  and  $I^2 = I$ . Basically, they specify that  $N(R, I)$  is not a classical ring with respect to Neutrosophic addition and Neutrosophic multiplication. Further investigation of Neutrosophic rings was done by Agboola, Akinola and Oyebolain [3, 4]. Recently, Chalapathi and Kiran studied the enumeration of Neutrosophic self additive inverse elements of Neutrosophic rings and fields in [5].

Neutrosophic rings are additive Neutrosophic groups with a new binary operation of Neutrosophic multiplication. This new kind of Neutrosophic multiplication operation constrains the new generated algebraic structures of classical rings and makes it more benefit than classical rings to obtained elementary structural theorems of indeterminacy modeled situations. So, the use of Neutrosophic algebraic theory becomes inevitable when a real world problem contains indeterminacy.

In this paper, we study some concepts of Neutrosophic units of Neutrosophic rings and fields explained with suitable examples, and examine properties satisfied by certain general collections of classical rings. The classical rings of primary interest are finite, so many of the results about classical groups and Neutrosophic groups will be helpful fundamentally.

## 2. Definitions and notations

In this section, we discuss the terminology used when working with the two Neutrosophic operations, namely Neutrosophic addition and Neutrosophic multiplication, in an abstractly given Neutrosophic rings. Before going to the abstract definition of a Neutrosophic ring, we get some definitions and notations by considering the classical rings from [6].

Let  $R$  be a ring. If there is an element  $1 \in R$  such that  $1 \neq 0$  and  $1a = a = a1$  for each element  $a \in R$ , we say that  $R$  is a ring with unity. The ring  $R$  is commutative if  $ab = ba$  for all  $a, b \in R$ . Suppose  $R$  has unity  $1$ . Then  $R^\times$  denote the units of  $R$ . So, an element  $u \in R^\times$  is a unit of  $R$  if there exist  $u' \in R^\times$  such that  $uu' = u'u = 1$ , and  $R^\times$  forms an abelian group under usual multiplication of  $R$ . Next the ring  $F$  is a field if its multiplication is commutative and if every non zero element of  $F$  is a unit. Now we recall that the following well known results about  $R^\times$  and  $F^\times$  from [6].

**Theorem.2.1** Let  $R$  and  $S$  be finite commutative rings. Then  $(R \times S)^\times \cong R^\times \times S^\times$  as groups. Also,  $|R^\times \times S^\times| = |R^\times| |S^\times|$ .

**Theorem.2.2** Let  $Z_n$  be the ring of integers modulo  $n$ . Then  $(Z_m \times Z_n)^\times \cong Z_m^\times \times Z_n^\times$  if and only if  $\gcd(m, n) = 1$ .

**Theorem.2.3** Let  $R$  be a finite Boolean ring. Then  $|R^\times| = 1$ .

**Theorem.2.4** Let  $F$  be a finite field of order  $n > 1$ . Then its unit group  $F^\times$  is a cyclic group of order  $n-1$ .

Now define the Neutrosophic group and these groups in general do not have classical group structure, which are defined specifically with respect to Neutrosophic multiplication as follows.

**Definition.2.5** Let  $(G, \cdot)$  be a multiplicative group. Then the set  $\langle G \cup I \rangle = \langle a, aI : a \in G, I^2 = I \rangle$  is called a Neutrosophic group generated by  $G$  and  $I$  under the operation on  $G$ , where  $I$  is the Neutrosophic element. Based on this definition we have the following.

1. Neutrosophic group  $\langle G \cup I \rangle$  of  $G$  is also denoted by  $N(G, I)$ .
2.  $N(G, I) = G \cup GI$ , where  $G \cap GI = \emptyset$  and  $GI = \{aI : a \in G\}$ .
3.  $G \subset N(G, I)$  and  $N(G, I) \not\subset G$ .
4. Let  $n \geq 1$  be a positive integer. Then  $(aI)^n = a^n I$  for every  $a \in G$ .

Now we proceed on to define the Neutrosophic ring and consider their basic properties from [2].

**Definition.2.6** Let  $(R, +, \cdot)$  be a ring. Then the Neutrosophic set  $N(R, I) = \{a + bI : a, b \in R, I^2 = I\}$  is called Neutrosophic ring generated by  $R$  and  $I$  under the following Neutrosophic addition and Neutrosophic multiplication operations.

1.  $(a + bI) + (c + dI) = (a + c) + (b + d)I$ .

$$2. (a+bI)(c+dI) = ac + (bc + ad + bd)I .$$

### Properties of $N(R, I)$ .2.7

1.  $R$  is a commutative ring with unity  $1 \Leftrightarrow N(R, I)$  is a commutative Neutrosophic ring with unity  $1$  and Neutrosophic unity  $I$ .
2. If  $R$  is finite ring then  $|N(R, I)| = |R|^2$ .
3. In general,  $I+I \neq I$  and  $-I \neq I$ , where  $-I$  exist in  $N(R, I)$ . In particular,  $-I = I$  if and only if  $N(R, I) \cong N(Z_2, I)$ .
4.  $I^n = I$  for each  $n > 1$

For further details about Neutrosophy and Neutrosophic rings the reader should refer [7, 8].

### 3. Neutrosophic units

In this section we define Neutrosophic units of finite commutative rings, fields and study its concrete properties which are comparing the group units of classical rings and fields.

**Definition.3.1** Let  $R^\times$  be the set of group units of the commutative ring  $R$ . Then the set

$$N(R^\times, I) = \langle u, uI : u \in R^\times, I^2 = I \rangle$$

is called Neutrosophic group units or simply Neutrosophic units generated by  $R^\times$  and  $I$  under the operations of  $R^\times$ , where  $I^{-1}$  does not exist.

### Examples.3.2

1.  $N(Z_3^\times, I) = \{1, 2, I, 2I\}$ .
2.  $N(Z_6^\times, I) = \{1, 5, I, 5I\}$ .

### Properties of $N(R^\times, I)$ .3.3

1.  $N(R^\times, I)$  is a Neutrosophic group but not a classical group.
2.  $R^\times \subset N(R^\times, I) \subset N(R, I)$ .
3.  $R^\times I \subset N(R^\times, I) \subset N(R, I)$ .
4.  $R^\times \cap R^\times I = \emptyset$  and  $N(R^\times, I) = R^\times \cup R^\times I$ .
5. For any  $u, u' \in R$ , the Neutrosophic element  $u+u'I$  is a Neutrosophic unit if and only if either  $u = 0$  or  $u' = 0$ .
6. Let  $N(R, I)$  be a Neutrosophic ring without zero divisors. Then for any  $u, u' \in R^\times$ ,  $uI = vI \Leftrightarrow uI - vI = 0 \Leftrightarrow (u-v)I = 0 \Leftrightarrow u = v$ , since  $I \neq 0$ .

**Theorem. 3.4** For any non-trivial integral domain  $R$  we have  $|R^\times| = |R^\times I|$ .

**Proof.** Define a map  $f : R^\times \rightarrow R^\times I$  by the relation  $f(u) = u^{-1}I$  for every  $u \in R^\times$ ,  $I^2 = I$  and  $I^{-1}$  does not exist. Trivially,  $f(1) = I$ . Further, for any  $u, v \in R^\times$ ,  $f(uv) = (uv)^{-1}I = u^{-1}v^{-1}I = (u^{-1}I)(v^{-1}I) = f(u)f(v)$  this



implies that  $f$  is a group homomorphism. Also, for each  $u \in R^\times$ , there exist unique  $u^{-1} \in R^\times$  such that  $f(u^{-1}) = (u^{-1})^{-1}I = uI$ ,  $f$  is onto. Finally,  $f(u) = f(v)$  implies that  $u^{-1}I = v^{-1}I$ .

Therefore,  $(1-uv^{-1})I = 0$  implies  $u=v$  because  $N(R, I)$  has no zero divisors and  $I \neq 0$ . This proves that there is a one-one correspondence between  $R^\times$  and  $R^\times I$ , and hence  $|R^\times| = |R^\times I|$ .

**Theorem.3.5** If  $|R|=1$ , then  $N(R^\times, I)$  is empty.

**Proof.** Follows from well-known result that  $R = \{0\}$  if and only if  $N(R, I) = \{0\}$ .

**Theorem. 3.6** For any finite non-trivial commutative ring  $R$  we have  $2 \leq |N(R^\times, I)| \leq 2|R^\times|$ .

**Proof.** Suppose  $|R|=2$ . Then  $R^\times = \{1\}$  and  $N(R^\times, I) = \{1, I\}$ . Therefore,  $|N(R^\times, I)| = 2$ , it is one extremity of the required inequality. Further, if  $|R| > 2$ , then by the definition of  $N(R^\times, I)$ , we have  $N(R^\times, I) = R^\times \cup R^\times I$  and  $R^\times \cap R^\times I = \emptyset$ . Thus, by the Theorem [3.4],  $|N(R^\times, I)| = |R^\times| + |R^\times I| = 2|R^\times|$ , which are maximum number of elements in  $N(R^\times, I)$ . This completes the proof.

In what follows here onward,  $\varphi(n)$  denotes the well known Euler-Totient function of the integer  $n \geq 1$ , which gives the number of positive integers less than  $n$  that are relatively prime to  $n$ . For more details of  $\varphi(n)$  we refer [9]. The immediate results are consequences of the Theorem [3.6].

**Corollary. 3.7** Let  $n > 1$  be a positive integer. Then the maximum number of elements in  $N(Z_n^\times, I)$  is  $2\varphi(n)$ . Moreover, this bound is sharp.

**Proof.** We know that  $Z_n^\times$  is the group of units of the ring  $Z_n$  of integers modulo  $n$ . Then clearly, in view of Theorem [3.6],  $|N(Z_n^\times, I)| = 2|Z_n^\times| = 2\varphi(n)$ .

**Corollary.3.8** Let  $n \geq 1$ . If  $R$  is a Boolean ring of order  $2^n$ , then  $|N(R^\times, I)| = 2$ .

**Proof.** By the Theorem [2.3], we know that  $R$  is a finite Boolean ring if and only if  $R^\times = \{1\}$ . Hence  $|N(R^\times, I)| = 2$ .

Let  $F$  be a finite field of order  $|F| > 1$ . Then  $F^* = F - \{0\} = F^\times$  is a cyclic group with respect to multiplication on  $F$ . But  $N(F^\times, I)$  is not a cyclic group with respect to either multiplication or Neutrosophic multiplication. However,  $F^\times I$  is a Neutrosophic semigroup and it is generated by  $uI$  where  $u$  generator of  $F^\times$ . In this connection we have to prove that the following results and for further information of fields and Neutrosophic field's reader refer [10] and [5], respectively.

**Theorem.3.9** The Neutrosophic group  $N(F^\times, I)$  is not a cyclic group.

**Proof.** By characterization of finite fields, it is well known that  $F$  be a finite field of order  $n$  if and only if  $F^\times$  is a cyclic group of order  $n-1$  with respect to multiplication defined on  $F$ . Therefore, for a generator  $u \in F^\times$  we have  $F^\times = \langle u \rangle$ . To complete the proof, it is enough to show that the Neutrosophic group  $N(F^\times, I)$  is not a cyclic. If possible assume that  $N(F^\times, I)$  generated by its Neutrosophic unit  $uI$ , then

$$\begin{aligned}
|N(F^\times, I)| = |uI| &\Rightarrow (n-1)^2 = |uI| \\
&\Rightarrow (uI)^{(n-1)^2} = 1 \\
&\Rightarrow u^{(n-1)^2} I^{(n-1)^2} = 1 \\
&\Rightarrow u^{(n-1)^2} I = 1,
\end{aligned}$$

which is not possible because  $I \neq 1$ ,  $u^{(n-1)^2} \neq 1$  and  $u^{(n-1)^2}$  is not multiplicative inverse of  $I$ .

The above theorem proves that the following result, which is of fundamental importance of Neutrosophic rings and fields.

**Theorem. 3.10**  $F^\times = \langle u \rangle$  if and only if  $F^\times I = \langle uI \rangle$ .

**Proof.** Let  $u \in F^\times$ . Then

$$\begin{aligned}
F^\times = \langle u \rangle &\Leftrightarrow u^{n-1} = 1 \text{ where } n = |F| \\
&\Leftrightarrow u^{n-1} I^{n-1} = I^{n-1} \\
&\Leftrightarrow (uI)^{n-1} = I \\
&\Leftrightarrow \langle uI \rangle = F^\times I.
\end{aligned}$$

We usually write  $uI = u = Iu$  for every  $u$  in  $R^\times$  and  $uI \neq u \neq Iu$  for every  $u \neq 1$  in  $R^\times$ . So, the element 1 is unity and  $I$  is not unity but it is Neutrosophic unit because  $I^2 = I$  and  $I^{-1}$  does not exist. The most familiar examples of infinite Neutrosophic units of infinite rings  $Z$  and  $Z[i]$ , respectively, are  $N(Z^\times, I) = \{1, -1, I, -I\}$  and  $N(Z[i]^\times, I) = \{1, -1, i, -i, I, -I, iI, -iI\}$  where  $i^2 = -1$  and  $I^2 = I$ . These examples support our claim that the sum of elements in  $N(R^\times, I)$  is zero. However, the following important results showing that the sum of elements of a Neutrosophic ring is zero when  $\text{char}(R) \neq 2$ . This is one of similar result of classical rings.

**Theorem. 3.11** If  $\text{char}(R) = 2$  then the sum of elements of  $N(R^\times, I)$  is not zero.

**Proof.** It is obvious because  $1, I \in N(R^\times, I)$  implies  $1 + I \neq 0$ .

**Theorem. 3.12** Let  $N(R^\times, I)$  be a commutative Neutrosophic ring whose characteristic is not equal to 2, then  $bI \neq -bI$  for every  $b \in R$ .

**Proof.** Suppose  $bI = -bI \Leftrightarrow 2bI = 0$  and

$$2a = 0 \Leftrightarrow 2(a + bI) = 0 \Leftrightarrow 2(a + bI) = 0 \Leftrightarrow \text{char}(N(R, I)) = 2 \text{ because } a + bI \in N(R, I).$$

**Theorem. 3.13** Let  $F$  be a finite field. If  $|F| > 2$  then the sum of the elements of  $N(F^\times, I)$  is zero.

**Proof.** Suppose that  $|F| = n > 2$ . Then the Neutrosophic units group  $N(F^\times, I)$  is the disjoint union of  $F^\times$  and  $F^\times I$ . By the Theorem [3.9] and Theorem [3.10], we have

$$\begin{aligned}
u^n = 1 \text{ and } (uI)^n = I &\Rightarrow 1 - u^n = 0 \text{ and } I - (uI)^n = 0 \\
&\Rightarrow (1 - u)(1 + u + u^2 + \dots + u^{n-1}) = 0 \text{ and} \\
&(I - uI)(I + uI + (uI)^2 + \dots + (uI)^{n-1}) = 0.
\end{aligned}$$

As  $uI \neq I$  and  $u \neq 1$ , these relations becomes

$$1 + u + u^2 + \dots + u^{n-1} = 0 \text{ and}$$

$$I + uI + (uI)^2 + \dots + (uI)^{n-1} = 0 .$$

This implies that the sum of elements in the Neutrosophic units group  $N(F^\times, I)$  is zero. Hence the result.

The following table illustrates the main differences between classical field and their Neutrosophic filed.

	Classical filed	Neutrosophic filed.
1	$ F  = p^n$	$ N(F, I)  = p^{2n}$
2	$F^\times$ is a group of order $p^n - 1$	$N(F^\times, I)$ is a Neutrosophic group of order $2(p^n - 1)$
3	$F^\times$ is a cyclic group	$N(F^\times, I)$ is not a cyclic group
4	$F^\times = \langle u \rangle$	$F^\times I = \langle uI \rangle$
5	$1 \in F^\times$	$1 \notin F^\times I$
6	$Z_2^\times = \{1\}$	$N(Z_2^\times, I) = \{1, I\}$

#### 4. Isomorphic properties of Neutrosophic units

Isomorphism of finite groups is central to the study of point symmetries and geometric symmetries of any object in the nature. They also provide abundant relations of abelian and non-abelian groups. If the group  $R^\times$  is isomorphic to the group  $S^\times$ , we write  $R^\times \cong S^\times$ , the map  $f : R^\times \rightarrow S^\times$  is an isomorphism if there exist a one-one and onto map such that the group operation preserved. The concept of isomorphism of groups is analogues to the concept of Neutrosophic isomorphism of Neutrosophic groups. For this reason the authors Agboola et al. [3, 4] and Chalapathi and Kiran [5] define Neutrosophic group isomorphism as follows.

**Definition.4.1** Two Neutrosophic groups  $N(R^\times, I)$  and  $N(S^\times, I)$  are Neutrosophic isomorphic if there exist a well-defined map  $\phi : N(R^\times, I) \rightarrow N(S^\times, I)$  such that

1.  $\phi(1) = 1$  and  $\phi(I) = I$ ,
2.  $\phi$  is a group homomorphism,
3.  $\phi$  is one-one correspondence.

If  $N(R^\times, I)$  is Neutrosophic isomorphic to  $N(S^\times, I)$ , we write  $N(R^\times, I) \cong N(S^\times, I)$ .

**Theorem.4.2** [6]. Let  $R$  and  $S$  be any two non-trivial finite commutative rings. Then  $R \cong S$  if and only if  $R^\times \cong S^\times$ .

An important consequence of above theorem is the following immediate in Neutrosophic rings which we state as a theorem in view of its importance throughout our study of Neutrosophic ring theory.

**Theorem.4.3** If  $R^\times \cong S^\times$  then  $N(R^\times, I) \cong N(S^\times, I)$ .

**Proof.** Let  $R^\times$  and  $S^\times$  be the set of units of the rings  $R$  and  $S$  respectively. Suppose,  $R^\times \cong S^\times$ . Then there exist a group isomorphism  $f: R^\times \rightarrow S^\times$  such that  $f(1) = 1$ . Now define a map  $\phi: N(R^\times, I) \rightarrow N(S^\times, I)$  by setting

$$\phi(x) = \begin{cases} f(x) & \text{if } x \in R^\times \\ f(x)I & \text{if } x \in R^\times I \end{cases}$$

for all  $x \in N(R^\times, I) = R^\times \cup R^\times I$ . Because  $f$  is a group isomorphism, we get  $\phi$  is well defined. For  $I \in R^\times I$ , we have  $\phi(I) = \phi(1I) = f(1)I = 1I = I$ . Next, we show that  $\phi$  is a homomorphism. Writing  $x$  for  $uI$  and  $y$  for  $u'I$ , where  $u, u' \in R^\times$ ,  $\phi(xy) = \phi((uI)(u'I)) = \phi(uu'I) = f(uu'I) = f(u)f(u')I = (f(u)I)(f(u')I) = \phi(x)\phi(y)$ . Clearly,  $\phi$  is onto, since  $f$  is onto. Finally, we show that  $\phi$  is one-one. For this let  $\phi(x) = \phi(y)$ , then  $f(u)I = f(u')I \Rightarrow (f(u) - f(u'))I = 0$

$$\Rightarrow f(u) - f(u') = 0, \text{ since } I \neq 0 \text{ and } f \text{ is one-one. Hence, } N(R^\times, I) \cong N(S^\times, I).$$

In view of the Theorem [2.2] and Theorem [4.3], the proof of the following result is obvious.

**Theorem. 4.4** Let  $m$  and  $n$  be two positive integers such that  $m > 1$  and  $n > 1$ . Then the following are equivalent.

1.  $\gcd(m, n) = 1$ ,
2.  $Z_{mn}^\times \cong Z_m^\times \times Z_n^\times$ ,
3.  $N(Z_{mn}^\times, I) \cong N(Z_m^\times, I) \times N(Z_n^\times, I)$ .

**Theorem. 4.5** Let  $m > 1$  and  $n > 1$  be any two positive integers. Then

$$N(Z_m^\times \times Z_n^\times, I) \cong N(Z_m^\times, I) \times N(Z_n^\times, I).$$

**Proof.** Let  $m > 1$  and  $n > 1$  be any two positive integers. By Theorem [2.1] and Corollary [3.7] we have

$$|Z_m^\times| = \phi(m), |Z_n^\times| = \phi(n) \text{ and } |N(Z_m^\times \times Z_n^\times, I)| = 2\phi(m)\phi(n). \text{ But}$$

$$|N(Z_m^\times, I) \times N(Z_n^\times, I)| = |N(Z_m^\times, I)| |N(Z_n^\times, I)|$$

$$= 4\phi(m)\phi(n). \text{ Hence the result.}$$

## Acknowledgments

The authors wish to express their cordial thanks to Prof. L. Nagamuni Reddy and Prof. S.Vijaya Kumar Varma for valuable suggestions to improve the presentation of this paper.

## References

- [1] W.B. Vasantha Kandasamy and Florentin Smarandache, Basic Neutrosophic Algebraic Structures and their Applications to Fuzzy and Neutrosophic Models, Hexis, Church Rock (2004).
- [2] W.B. Vasantha Kandasamy and F. Smarandache, Some Neutrosophic Algebraic Structures and Neutrosophic N-Algebraic Structures, Hexis, Phoenix, Arizona (2006).
- [3] A.A.A. Agboola, A.D. Akinola and O.Y.Oyebola, Neutrosophic Rings I, Int. J. of Math. Comb, 4(2011)1-14.
- [4] A.A.A. Agboola, E.O. Adeleke and S.A. Akinleye, Neutrosophic Rings II, International J.Math. Combin, 2(2012) 1-8.
- [5] T.Chalapathi and R.V.M.S.S.Kiran Kumar, Self Additive Inverse Elements of Neutrosophic Rings and Fields, Annals of Pure and Applied Mathematics, 13 (2017) 63-72.
- [6] L. Gilbert, Elements of Modern Algebra, 8<sup>th</sup> edition, Cengage Learning, (2014).

- [7] P. Majumdar, Neutrosophic Sets and Its Applications to Decision Making, Computational Intelligence for Big Data Analysis, Springer International Publishing, Switzerland, 19(2015)97-115.
- [8] T Chalapathi and R.V.M.S.S. Kiran Kumar, Neutrosophic Graphs of Finite Groups, Neutrosophic Sets and Systems, 15 (2017) 22-30.
- [9] Tom M. Apostol, Introduction to Analytic Number Theory, Springer Science & Business Media, (1998).
- [10] Gary L. Mullen, Daniel Panario, Handbook of Finite Fields, Taylor & Francis, CRC Press, (2013).

Received: May 15, 2018. Accepted: June 4, 2018.



# Neutrosophic Approach to Grayscale Images Domain

A. A. Salama<sup>1</sup>, Florentin Smarandache<sup>2</sup> and Hewayda ElGhawalby<sup>3</sup>

<sup>1</sup>Department of Mathematics and Computer Science, Faculty of Science, Port Said University, Egypt

E-mails : [drsalama44@gmail.com](mailto:drsalama44@gmail.com)

<sup>2</sup>Department of Mathematics, University of New Mexico, 705 Gurley Avenue, Gallup, NM 87301, USA.

E-mail: [fsmarandache@gmail.com](mailto:fsmarandache@gmail.com)

<sup>3</sup>Department of Physics and Engineering Mathematics, Faculty of Engineering, Port Said University, Egypt.

**Abstract.** In this paper, we propose a new technique for the enhancing images. It will work on removing the noise contained in the image as well as improving its contrast based on three different enhancing transforms, we commence by embedding the image into a neutrosophic domain; where the image will be mapped in three different levels, a level of trueness, a level of false-ness and a level of indeterminacy. Hence, we act separately on each level using the enhancement transforms. Finally, we introduce a new analysis in the field of analysis and processing of images using the neutrosophic crisp set theory via Mat lab program where has been obtained three images, which helps in a new analysis to improve and retrieve images.

**Keywords:** Image analysis, Image Enhancement, Image processing, Neutrosophic Crisp Set, Gaussian Distribution, Logarithmic Transform, Neutrosophic Crisp Mathematical Morphology

## 1. Introduction

As a discipline, neutrosophic is an active and growing area of image processing and analysis. Mathematically, a gray scale image is represented by an  $m \times n$  array  $I_m = [g(i, j)]_{m \times n}$  with entities  $g(i, j)$  corresponding to the intensity of the pixel located at  $(i, j)$ . Presently applications require different kinds of images as sources of information for interpretation and analysis. Whenever an image is converted from one form to another (such as digitizing, scanning, transmitting, storing, etc.) some form of declination occurs at the output. Hence, the output image has to undergo a process called image enhancement which consists of a collection of techniques that seek to improve the visual appearance of an image [12]. Image enhancement is a process which mainly used to improve the quality of images, removing noise from the images. It has important role in many fields like high definition TV (HDTV), X-ray processing, motion detection, remote sensing and in studying medical images [8]. The fundamental concepts of neutrosophic set, introduced by Smarandache in [22, 23] and many applications, introduced by Salama et al. in [14-21], [27, 28] provides a natural foundation for treating mathematically the neutrosophic phenomena which exist pervasively in our real world and for building new branches of neutrosophic mathematics, as an extension of the concept of the fuzzy set theory introduced by Zadeh [25].

## 2. Preliminaries

we recall some definitions for essential concepts of neutrosophic sets and its operations, which were introduced by Smarandache in [22, 23] and many applications by Salama et al. in [14-21].

### 2.1. Image Enhancement

Recent applications are in need of different kinds of images as a source of information for interpretation and analysis. Whenever an image is transformed from one structure to another, such as: digitizing, scanning, and transmitting, some kind of distortion might occur to the output image. Hence, a process called image enhancement must be done. The process of an image enhancement contains a collection of techniques with the aim of providing a better visual appearance of the image; it is to improve the image quality so that the

resultant image is better than the original image for a specific application. In other words, to convert the image to an appropriate form for analysis by either a human eye or a machine. Currently, the image enhancement research covers wide topics such as: algorithms based on the human visual system [6], histograms with hue-preservation [9], JPEG-based enhancement for the visually impaired [24], and histogram modification techniques [5]. Additive noise, Gaussian noise, Impulse noise and Poisson noise represent several types of noises that corrupt the image, to remove any of such there are various filters available. For instance: Gaussian filter, Median filter, High pass filter and Low pass filter; each of these can be used to remove the image noise and, hence, enhance the image. The applications of image enhancement are in every field where images are needed to be understood and analyzed, as in medical image analysis, and analysis of images from satellites. Generally, the enhancement techniques can be categorized into two main groups, which are the Spatial Domain Methods and the Frequency Domain Methods [26].

## 2.2. Spatial Domain for Image Enhancement

The spatial domain is the normal image space, which is a direct handling of image pixels [2]. It is the manipulation or the change of image representations. Moreover, spatial domain is used in several applications as smoothing, sharpening and filtering images. Spatial domain techniques such as the logarithmic transforms[7], power law transforms[11], and histogram equalization[13], are basically to perform on the direct manipulation of the image pixels. In practice, spatial techniques are useful for directly changing the gray level intensities of individual pixels and consequently the contrast of the entire image. Usually, the spatial domain techniques enhance the whole image uniformly, which in various cases produces undesirable results and do not make it possible to efficiently enhance edges or other required information.

## 2.3 Frequency Domain for Image Enhancement

While in the spatial domain an image is treated as it is, and the value of the pixels of the image changes with respect to the scene, in the frequency domain we are dealing with the rate at which the values of the pixel are changing in the spatial domain. In all the methods applied, a Fourier transform of the image is firstly computed so that the image is transferred into the frequency domain. Hence, any operation used for the purpose of image enhancement will be performed on the Fourier transform of the image. Afterward an Inverse Fourier transform is performed to obtain the resultant image. The main objective of all the enhancement operations is to modify the image contrast, brightness or the grey levels distribution. Therefore, the value of the pixels of the output image will be changed according to the transformation applied on the input values. In image processing and image analysis, the image transform is a mathematical tool which is used for detecting the rough or unclear area in the image and fix it. The image transformation allows us to move from frequency domain to time domain to perform the desired task in an easy manner. Various types of image transforms are available such as Fourier Transform [1], Walsh Transform [10], Hadamard Transform, Stant Transform, and Wavelet Transform [4]. The image transformation to neutrosophic domain in [3]

## 3. Hesitancy Degrees with Neutrosophic Image Domain

Salama et al. in [27, 28] presented the texture features for images embedded in the neutrosophic domain with Hesitancy degree.

### Definition 3.1 [15,27,28]:

Let  $A = \{(\mu_A(x), \nu_A(x), \gamma_A(x)), x \in X\}$  on  $X = \{x_1, x_2, x_3, \dots, x_n\}$ . Then for a Neutrosophic set  $A = \{(\mu_A(x), \nu_A(x), \gamma_A(x)), x \in X\}$  in  $X$ , We call  $\pi_A(x) = 3 - \mu_A(x) - \nu_A(x) - \gamma_A(x)$ , the Neutrosophic index of  $x$  in  $A$ , It is a hesitancy degree of  $x$  to  $A$  it is obvious that  $0 \leq \pi_A(x) \leq 3$ .

In this section we are transforming the image  $I_m$  into a neutrosophic domain using four functions:  $T$ ,  $I$ ,  $F$  and  $\pi$ . A pixel  $P(i, j)$  in the image is described by a forth  $(T(i, j); I(i, j); F(i, j); \pi(i, j))$ . Where  $T(i, j)$  is the membership degree of the pixel in the white set, and  $F(i, j)$  is its membership degree in the non-white (black) set; while  $I(i, j)$  is how much it is neither white nor black;  $k$  and  $\pi(i, j)$  is hesitancy degree. The values of  $T(i, j)$ ,  $I(i, j)$ ,  $F(i, j)$  and  $\pi(i, j)$  are defined as follows:

$$T(i, j) = \frac{\bar{g}(i, j) - \bar{g}_{\min}}{\bar{g}_{\max} - \bar{g}_{\min}}, \quad I(i, j) = 1 - \frac{\delta(i, j) - \delta_{\min}}{\delta_{\max} - \delta_{\min}},$$

$$F(i, j) = 1 - T(i, j),$$

$\pi(i, j) = 3 - (T(i, j) + I(i, j) + F(i, j))$ , where  $\bar{g}(i, j)$  is the local mean intensity in some neighborhood  $w$  of the pixel,

$$\bar{g}(i, j) = \frac{1}{w \times w} \sum_{u=i-w/2}^{u=i+w/2} \sum_{v=j-w/2}^{v=j+w/2} g(u, v), \quad \delta(i, j) \text{ is the homogeneity value computed by the absolute value of difference between the}$$

intensity and its local mean value  $\delta(i, j) = \text{abs}(g(i, j) - \bar{g}(i, j))$ .

#### 4. A Neutrosophic Image Enhancement Filter

Consider an Image  $G$  in the neutrosophic domain with four functions  $(T, I, F, \pi)$  describing the three levels of trueness, indeterminacy and falseness with hesitancy degree as previously explained in 2. The filter we propose to enhance  $G$  is two fold. In one hand it aims to remove the noise from the image, in the other hand it improves the image contrast. To do so, we will work on each level separately.

Firstly, in the indeterminacy level, we will force the stability of this blur area around the mean using the Gaussian distribution.

A general form of the Gaussian distribution is  $\phi\left(\frac{t-\mu}{\sigma}\right)$ , where  $\sigma$  is the standard deviation and  $\mu$  is the mean value. Secondly, in the

falseness level, a logarithmic transform is applied to enhance the details in ; 2 the dark areas while considering the brighter ones. Its general form is,  $c \log(1 + t)$ , where  $t$  is assumed to be non-negative;  $t \geq 0$ , and  $c$  is a scaling parameter.

Thirdly, a power-law transform is working over the shattered areas in the trueness level. The power law transformations include the  $n^{\text{th}}$  power and the  $n^{\text{th}}$  root transformation, these transformations are also known as gamma transformation and can be given by the general expression,  $cr^\gamma$ . Variation in the value of  $\gamma$  varies the enhancement of the images. Finally, we have got the output image,  $\bar{G}$  of the

enhancement process with the triple  $(\bar{T}, \bar{I}, \bar{F}, \bar{\pi})$  where

$$\bar{T}(i, j) = CT^\gamma(i, j),$$

$$\bar{I}(i, j) = \frac{1}{\sigma\sqrt{2\pi}} \exp\left(-\frac{(I(i, j) - \mu)^2}{2\sigma^2}\right), \quad (2)$$

$$\bar{F}(i, j) = C \ln(1 + F(i, j)),$$

$$\bar{\pi} = 3 - (\bar{T}(i, j) + \bar{I}(i, j) + \bar{F}(i, j))$$

#### 5. A Neutrosophic Crisp Operators for Grayscale Image

##### 5.1. Grayscale Image via Neutrosophic Crisp Domain.

In this section, we introduce a new analysis in the field of analysis and processing of images using the neutrosophic crisp set theory due to Salama et al. in [14,17] via Matlab program where has been obtained three images representing, which helps in a new analysis to improve and retrieve images

A grayscale image in a 2D Cartesian domain

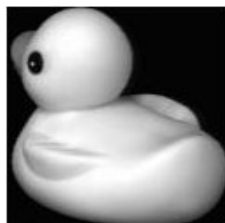

Fig. 1: a) Grayscale image

The following figure shows a grayscale image in a neutrosophic crisp components.





Fig. 1: b) Neutrosophic Crisp Components  $(A_1, A_2, A_3)$  respectively

At this point, we have noticed that there exist some crisp sets which having the neutrosophic triple structure and are not classified in either categories of the neutrosophic crisp sets' classification. In this case, the three components of those sets may overlap. In this section, we deduced a new triple structured set; where the three components are disjoint.

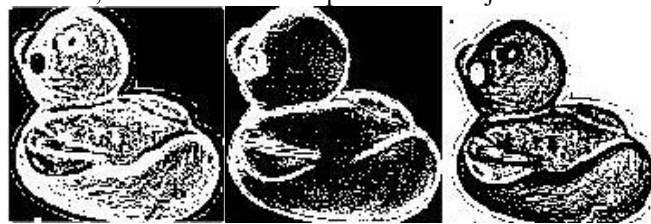

Fig. 2: b) Neutrosophic Crisp Components  $(A_1, A_2, A_3)$  respectively

The following figure shows a grayscale image in star neutrosophic crisp components.



Fig. 3 b) Star Neutrosophic Crisp Components  $(A_1, A_2, A_3)$  respectively

**Definition 5.1**

For any triple structured crisp set  $A$ , of the form  $A = (A_1, A_2, A_3)$ ; the retract neutrosophic crisp set  $A^r$  is the structure  $A^r = (A_1^r, A_2^r, A_3^r)$ , where

$$A_1^r = A_1 \cap \text{co}(A_2 \cup A_3), A_2^r = A_2 \cap \text{co}(A_1 \cup A_3)$$

$$A_3^r = A_3 \cap \text{co}(A_1 \cup A_2), \text{ Furthermore, the three components } A_1^r, A_2^r \text{ and } A_3^r \text{ are disjoint and } A_i^r \subseteq A_i, \forall i = 1, 2, 3. \text{ and}$$

The following figure shows a grayscale image in a neutrosophic retract crisp components.

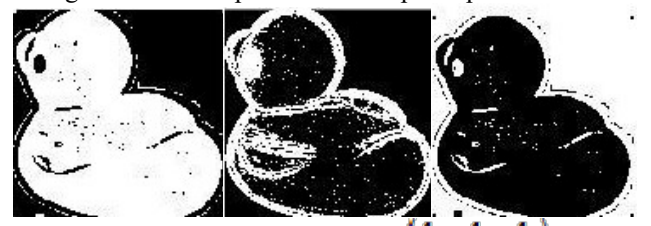

Fig.4: b) Neutrosophic Retract Components  $(A_1, A_2, A_3)$  respectively

**5.2. A Grayscale Image & Neutrosophic Crisp Operators**

Salama et al. [17] extended the definitions of some morphological filters using the neutrosophic crisp sets concept. The idea behind the new introduced operators and filters is to act on the image in the neutrosophic crisp domain instead of the spatial domain. The following figure shows a grayscale image in a neutrosophic crisp Dilation components.



Fig.5: Neutrosophic Crisp Dilation components in type 1  $(A_1, A_2, A_3)$  respectively



Fig.6: Neutrosophic Crisp Dilation components in type 2  $(A_1, A_2, A_3)$  respectively

The following figure shows a grayscale image in a neutrosophic crisp **Erosion** components.



Fig.7: Neutrosophic Crisp Erosion components in type 1  $(A_1, A_2, A_3)$  respectively



Fig.8: Neutrosophic Crisp Erosion components in type2  $(A_1, A_2, A_3)$  respectively

The following figure shows a grayscale image in a neutrosophic crisp **Opening** components.



Fig.9: Neutrosophic Crisp opening components in type1  $(A_1, A_2, A_3)$  respectively



Fig.10: Neutrosophic Crisp opening components in type2  $(A_1, A_2, A_3)$  respectively

The following figure shows a grayscale image in a neutrosophic crisp **Closing** components.



Fig.11: Neutrosophic Crisp closing components in type1  $\langle A^1, A^2, A^3 \rangle$  respectively



Fig.12: Neutrosophic Crisp closing components in type2  $\langle A^1, A^2, A^3 \rangle$  respectively

## Conclusion

As a discipline, neutrosophic is an active and growing area of image processing and analysis. In this work, we introduce a neutrosophic technique for the image processing, analysis and enhancement. The two fold proposed technique aims to remove the noise from the image, as well as improving the image contrast. To commence, we construct the embedding of the image in the neutrosophic domain; in which the image is mapped into three different levels, describing the levels of trueness, falseness and indeterminacy. Using the Power-law, Logarithmic and Gaussian transforms, the proposed a technique acts on each level of the image separately. Our plan next is to experiment our technique on different types of images, such as medical images.

## REFERENCES

- [1] S. Aghagolzadeh and O. Ersoy, Transform image enhancement. *Optical Engineering*, 31(3) (1992), 614-626.
- [2] B. Chanda, and D. Majumder, *Digital Image Processing and Analysis*. New Delhi: Prentice-Hall of India, 2002.
- [3] H. D Cheng,., Y. Guot, Y. Zhang, A Novel Image Segmentation Approach Based on Neutrosophic Set And Improved Fuzzy C-Means Algorithm, *World Scientific Publishing Company, New Math. and Natural Computation*, Vol. 7, No.1, 155-171, 2011.
- [4] D. L. Donoho and M. E. Raimondo, A fast wavelet algorithm for image deblurring. *ANZIAM J.* 46 (2005), C29 -C46.
- [5] J. Duan and G. Qiu, Novel histogram processing for colour image enhancement. *Third Intl. Conf. on Image and Graphics (Dec. 2004)*, 55-58.
- [6] K. Huang, Q. Wang and Z.Wu, Color image enhancement and evaluation algorithm based on human visual system. *Proc. IEEE ICASSP 3 (May 2004)*, iii 721-iii 724.
- [7] R. R. Jain, Kasturi and B. G. Schunck, *Machine Vision*. Mc Graw-Hill International Edition, 1995.
- [8] M. K. Khehra and M. Devgun, Survey on Image Enhancement Techniques for Digital Images. *Scholars Journal of Engineering and Technology (SJET)*; 2015; 3(2B):202-206.
- [9] S. K. Naik, and C. A. Murthy, Hue-preserving color image enhancement without gamut problem. *IEEE Trans. on Image Processing* 12, 12 (Dec. 2001), 1591-1598.
- [10] M. Petrou, and P. Bosdogianni, *Image Processing - The Fundamentals*. NewYork: Wiley, 1999.
- [11] W. K. Pratt, *Digital image processing*. Prentice Hall, 1989.
- [12] D. H. Rao, & P. P. Panduranga, A Survey on Image Enhancement Techniques: Classical Spatial Filter, Neural Network, Cellular Neural Network, and Fuzzy Filter. In *2006 IEEE International Conference on Industrial Technology*.
- [13] J. Russ, *The Image Processing Handbook*. CRC Press, 1992.
- [14] A. A. Salama, F.Smarandache, *Neutrosophic Crisp Set Theory*, Educational. Education Publishing 1313 Chesapeake, Avenue, Columbus, Ohio 43212(2015)
- [15] A. A. Salama, Florentin Smarandache and Mohamed Eisa, introduction to image processing via neutrosophic techniques, *Neutrosophic Sets and Systems*, (5), (2014) 59-64.
- [16] Haitham ELwahsha , Mona Gamala, A. A. Salama, I.M. El-Henawy, Modeling Neutrosophic Data by Self-Organizing Feature Map: MANETs Data Case Study, *Procida Computer*, Vol.121, pp152-157, 2017.
- [17] Eman.M.El-Nakeeb, Hewayda ElGhawalby, A.A. Salama, S.A.El-Hafeez: Neutrosophic Crisp Mathematical Morphology, *Neutrosophic Sets and Systems*, Vol. 16 (2017), pp. 57-69.
- [18] A. A. Salama, and F . Smarandache, Filters via Neutrosophic Crisp Sets, *NeutrosophicSets and Systems*, 1(1), (2013) pp.34-38.
- [19] A. A. Salama, Mohamed Eisa, Hewayda ElGhawalby, A. E. Fawzy, Neutrosophic Features for Image Retrieval, *Neutrosophic Sets and Systems*, vol. 13, 2016, pp. 56-61.
- [20] A. A Salama, Haitham A. El-Ghareeb, Ayman M. Manie, M. M Lotfy, Utilizing Neutrosophic Set in Social Network Analysis e-Learning Systems, *International Journal of Information Science and Intelligent System*, 3(4): (2014) 61-72.
- [21] A A Salama, Mohamed Eisa and A. E. Fawzy. A Neutrosophic Image Retrieval Classifier. *International Journal of Computer Applications* 170 (9): (2017) 1-6.
- [22] F. Smarandache, *Neutrosophy and Neutrosophic Logic*, First International Conference on Neutrosophy , Neutrosophic Logic , Set, Probability, and Statistics University of New Mexico, Gallup, NM 87301, USA(2002).

- [23] F. Smarandache. A Unifying Field in Logics: Neutrosophic Logic. Neutrosophic, Neutrosophic Set, Neutrosophic Probability. American Research Press, Rehoboth, NM, (1999).
- [24] Tang, J., Kim, J., and Peli, E. Image enhancement in the jpeg domain for people with vision impairment. *IEEE Trans. on Biomedical Engineering* 51, 11 (Nov. 2004), 2013-2023.
- [25] L. A. Zadeh, *Fuzzy Sets, Inform and Control* 8, (1965) 338-353.
- [26] C., J. Zhang, Wang, X. Wang and H. Feng, Contrast enhancement for image with incomplete beta transform and wavelet neural network. *Neural Networks and Brain* 2 (2005), 1236 -1241.
- [27] A. A. Salama, Hewayda ElGhawalby and A. E. Fawzy, Neutrosophic Image Retrieval with Hesitancy Degree, *New Trends in Neutrosophic Theories and Applications*, Vol.II Edited by Florentin Smarandache, Surapati Pramanik 2018, pp 237-242.
- [28] Arindam Dey, Said Broumi, Le Hoang Son, Assia Bakali, Mohamed Talea, Florentin Smarandache, "A new algorithm for finding minimum spanning trees with undirected neutrosophic graphs", *Granular Computing* (Springer), pp.1-7, 2018.
- [29] S Broumi, A Dey, A Bakali, M Talea, F Smarandache, LH Son, D Koley, "Uniform Single Valued Neutrosophic Graphs", *Neutrosophic sets and systems*, 2017.
- [30] S Broumi, A Bakali, M Talea, F Smarandache, A. Dey, LH Son, "Spanning tree problem with Neutrosophic edge weights", in *Proceedings of the 3rd International Conference on intelligence computing in data science*, Elsevier, science direct, Procedia computer science, 2018.
- [31] Said Broumi; Arindam Dey; Assia Bakali; Mohamed Talea; Florentin Smarandache; Dipak Koley, "An algorithmic approach for computing the complement of intuitionistic fuzzy graphs" 2017 13th International Conference on Natural Computation, Fuzzy Systems and Knowledge Discovery (ICNC-FSKD)
- [32] Abdel-Basset, M., Mohamed, M., Smarandache, F., & Chang, V. (2018). Neutrosophic Association Rule Mining Algorithm for Big Data Analysis. *Symmetry*, 10(4), 106.
- [33] Abdel-Basset, M., & Mohamed, M. (2018). The Role of Single Valued Neutrosophic Sets and Rough Sets in Smart City: Imperfect and Incomplete Information Systems. *Measurement*. [Volume 124](#), August 2018, Pages 47-55
- [34] Abdel-Basset, M., Gunasekaran, M., Mohamed, M., & Smarandache, F. A novel method for solving the fully neutrosophic linear programming problems. *Neural Computing and Applications*, 1-11.
- [35] Abdel-Basset, M., Manogaran, G., Gamal, A., & Smarandache, F. (2018). A hybrid approach of neutrosophic sets and DEMATEL method for developing supplier selection criteria. *Design Automation for Embedded Systems*, 1-22.
- [36] Abdel-Basset, M., Mohamed, M., & Chang, V. (2018). NMCDA: A framework for evaluating cloud computing services. *Future Generation Computer Systems*, 86, 12-29.
- [37] Abdel-Basset, M., Mohamed, M., Zhou, Y., & Hezam, I. (2017). Multi-criteria group decision making based on neutrosophic analytic hierarchy process. *Journal of Intelligent & Fuzzy Systems*, 33(6), 4055-4066.
- [38] Abdel-Basset, M.; Mohamed, M.; Smarandache, F. An Extension of Neutrosophic AHP-SWOT Analysis for Strategic Planning and Decision-Making. *Symmetry* 2018, 10, 116.
- [28] Abdel-Basset, Mohamed, et al. "A novel group decision-making model based on triangular neutrosophic numbers." *Soft Computing* (2017): 1-15. DOI: <https://doi.org/10.1007/s00500-017-2758-5>
- [39] Abdel-Baset, Mohamed, Ibrahim M. Hezam, and Florentin Smarandache. "Neutrosophic goal programming." *Neutrosophic Sets Syst* 11 (2016): 112-118.
- [40] El-Hefenawy, Nancy, et al. "A review on the applications of neutrosophic sets." *Journal of Computational and Theoretical Nanoscience* 13.1 (2016): 936-944.

Received: June 7, 2018. Accepted: July 5, 2018.



# Neutrosophic Triplet Normed Ring Space

Mehmet Şahin<sup>1</sup>, Abdullah Kargın<sup>2</sup>

<sup>1</sup> Department of Mathematics, Gaziantep University, Gaziantep, 27000, Turkey. E-mail: mesahin@gantep.edu.tr

<sup>2</sup> Department of Mathematics, Gaziantep University, Gaziantep, 27000, Turkey. E-mail: abdullahkargin27@gmail.com

**Abstract.** In this article, a notion of neutrosophic triplet (NT) normed ring space is given and properties of NT normed ring spaces are studied. We demonstrate that NT normed ring is different from the classical one. Also, we show that a neutrosophic triplet normed ring can be a neutrosophic triplet norm when certain conditions are met.

**Keywords:** Neutrosophic triplet set, neutrosophic triplet ring, neutrosophic triplet normed ring.

## 1 Introduction

Neutrosophy is a branch of philosophy, introduced by Smarandache in 1980, which studies the origin, nature and scope of neutralities, as good as their interactions with distinctive ideational spectra. Neutrosophy is the basis of neutrosophic logic, neutrosophic probability, neutrosophic set and neutrosophic facts in [1]. Neutrosophic logic is a general framework for unification of many existing logics such as fuzzy logic which is introduced by Zadeh in [2] and intuitionistic fuzzy logic which is introduced by Atanassov in [3]. Fuzzy set has best measure of membership; intuitionistic fuzzy set has most effective degree of membership and degree of non-membership. Thus; they do not explain the indeterminacy states. But neutrosophic set has degree of membership (t), degree of indeterminacy (i) and degree of non-membership (f) and define the neutrosophic set on three components (t, i, f). A lot of researchers have been dealing with neutrosophic set theory in [4-22]. Recently; Broumi, Bakali, Talea and Smarandache studied the single valued neutrosophic graphs in [23] and interval valued neutrosophic graphs in [24]. Liu studied the aggregation operators based on Archimedean t-conorm and t-norm for the single valued neutrosophic numbers in [25]. Additionally, Smarandache and Ali introduced NT theory in [26] and NT groups in [27, 28]. The NT set is completely different from the classical one, since for each element “a” in NT set N together with a binary operation \*; there exist a neutral of “a” called neut(a) such that  $a * \text{neut}(a) = \text{neut}(a) * a = a$  and an opposite of “a” called anti(a) such that  $a * \text{anti}(a) = \text{anti}(a) * a = \text{neut}(a)$ . Where, neut(a) is different from the classical algebraic unitary element. A NT is of the form  $\langle a, \text{neut}(a), \text{anti}(a) \rangle$ . Also, Smarandache and Ali studied the NT field in [29] and the NT ring in [30]. Recently, some researchers have been dealing with NT set thought. For instance, Şahin and Kargın introduced NT metric space, NT vector space and NT normed space in [31]. Şahin and Kargın studied NT inner product in [32].

Normed ring is an algebraic structure. Some of the properties of the normed rings are similarly to some of the properties of the classical norms, but the normed rings also have their own characteristic properties. Shilov introduced the notion of commutative normed ring in [33] and Jarden introduced the notion of normed ring in [34]. Recently Ulucay, Şahin and Olgun introduced normed rings with soft set theory in [35].

In this paper, we introduced NT normed ring space and we give properties of NT normed ring space. In section 2, we give some preliminary results and definition for NT structures. In section 3, NT normed ring space is defined and some properties of a NT normed ring space are given. It is show that NT normed ring is different from the classical normed ring. Also, it is show that if certain conditions are met, every NT normed ring can be a NT metric and NT norm at the same time. Furthermore, the convergence of a sequence and a Cauchy sequence in a NT normed ring space are defined. In section 4, conclusions are given.

## 2 Preliminaries

**Definition 2.1.** [27] Let N be a set together with a binary operation \*. Then, N is called a NT set if for any  $a \in N$ , there exists a neutral of “a” called neut(a), different from the classical algebraic unitary element, and an opposite of “a” called anti(a), with neut(a) and anti(a) belonging to N, such that

$$a * \text{neut}(a) = \text{neut}(a) * a = a$$

$$a * \text{anti}(a) = \text{anti}(a) * a = \text{neut}(a).$$

The elements  $a$ ,  $\text{neut}(a)$  and  $\text{anti}(a)$  are collectively called as neutrosophic triplet, and we denote it by  $(a, \text{neut}(a), \text{anti}(a))$ . Here, we mean neutral of  $a$  and apparently, “ $a$ ” is just the first coordinate of a NT and it is not a neutrosophic triplet. For the same element “ $a$ ” in  $N$ , there may be more neutrals to it  $\text{neut}(a)$ ’s and more opposites of it  $\text{anti}(a)$ ’s.

**Theorem 2.2.** [27] Let  $(N, *)$  be a commutative NT group with respect to  $*$  and  $a, b \in N$ ;

- i)  $\text{neut}(a) * \text{neut}(b) = \text{neut}(a * b)$ ;
- ii)  $\text{anti}(a) * \text{anti}(b) = \text{anti}(a * b)$ ;

**Definition 2.3.** [29] Let  $(NTF, *, \#)$  be a NT set together with two binary operations  $*$  and  $\#$ . Then  $(NTF, *, \#)$  is called NT field if the following conditions hold.

- i.  $(NTF, *)$  is a commutative NT group with respect to  $*$
- ii.  $(NTF, \#)$  is a NT group with respect to  $\#$ .
- iii.  $a \# (b * c) = (a \# b) * (a \# c)$  and  $(b * c) \# a = (b \# a) * (c \# a)$  for all  $a, b, c \in NTF$ .

**Definition 2.4.** [30] The NT ring is a set endowed with two binary laws  $(M, *, \#)$  such that,

- a)  $(M, *)$  is a commutative NT group; which means that:
  - $(M, *)$  is a commutative neutrosophic triplets with respect to the law  $*$  (i.e. if  $x$  belongs to  $M$ , then  $\text{neut}(x)$  and  $\text{anti}(x)$ , defined with respect to the law  $*$ , also belong to  $M$ )
  - The law  $*$  is well – defined, associative, and commutative on  $M$  (as in the classical sense);
- b)  $(M, \#)$  is a set such that the law  $\#$  on  $M$  is well-defined and associative (as in the classical sense);
- c) The law is distributive with respect to the law  $*$  (as in the classical sense)

**Theorem 2.5.** [31] Let  $(N, *)$  be a NT group with no zero divisors and with respect to  $*$ . For  $a \in N$ ,

- i)  $\text{neut}(\text{neut}(a)) = \text{neut}(a)$
- ii)  $\text{anti}(\text{neut}(a)) = \text{neut}(a)$
- iii)  $\text{anti}(\text{anti}(a)) = a$
- iv)  $\text{neut}(\text{anti}(a)) = \text{neut}(a)$

**Theorem 2.6.** [31] Let  $(NTV, *, \#)$  be a NT vector space on a NT field. If  $(NTV, *, \#)$  is satisfies the following condition,  $(NTV, *, \#)$  is also a NT field;

- 1)  $a \# b \in NTV$ ; for all  $a, b \in NTV$ ;
- 2)  $a \# (b \# c) = (a \# b) \# c$ ; for all  $a, b, c \in NTV$ ;
- 3)  $a \# (b * c) = (a \# b) * (a \# c)$  and  $(b * c) \# a = (b \# a) * (c \# a)$ ; for all  $a, b, c \in NTV$ .

**Definition 2.7.** [31] Let  $(N, *)$  be a NT set and let  $x * y \in N$  for all  $x, y \in N$ . If the function  $d: N \times N \rightarrow \mathbb{R}^+ \cup \{0\}$  satisfies the following conditions;  $d$  is called a NT metric. For all  $x, y, z \in N$ ;

- a)  $d(x, y) \geq 0$ ;
- b) If  $x = y$ ; then  $d(x, y) = 0$
- c)  $d(x, y) = d(y, x)$
- d) If there exists any element  $y \in N$  such that;  
 $d(x, z) \leq d(x, z * \text{neut}(y))$ , then  
 $d(x, z * \text{neut}(y)) \leq d(x, y) + d(y, z)$ .

Furthermore,  $((N, *), d)$  is called NT metric space.

**Definition 2.8.** [31] Let  $(NTV, *_{\#_2}, \#_{\#_1})$  be a NT vector space on  $(NTF, *, *_{\#_1}, \#_{\#_1})$  NT field. If  $|| \cdot || : NTV \rightarrow \mathbb{R}^+ \cup \{0\}$  function satisfies following condition;  $|| \cdot ||$  is called NT normed on  $(NTV, *_{\#_2}, \#_{\#_2})$ . Where;

- f:  $NTF \times NTV \rightarrow \mathbb{R}^+ \cup \{0\}$ ,  $f(\alpha, x) = f(\text{anti}(\alpha), \text{anti}(x))$
- is a function and for every  $x, y \in NTV$  and  $\alpha \in NTF$ ;
- a)  $||x|| \geq 0$ ;
  - b) If  $x = \text{neut}(x)$ , then  $||x|| = 0$
  - c)  $||\alpha \#_{\#_2} x|| = f(\alpha, x) \cdot ||x||$
  - d)  $||\text{anti}(x)|| = ||x||$
  - e) If there exists any element  $k \in NTV$  such that  $||x *_{\#_2} y|| \leq ||x *_{\#_2} y *_{\#_2} \text{neut}(k)||$  then;

$$\|x *_2 y *_2 \text{neut}(k)\| \leq \|x\| + \|y\|.$$

Furthermore,  $((\text{NTV}, *_2, \#_2), \|\cdot\|)$  is called a NT normed space on  $(\text{NTE}, *_2, \#_2)$  NT field.

**Definition 2.9.** [34] Let  $R$  be an associative ring with 1. A norm on  $R$  is a function  $\|\cdot\| : R \rightarrow R$  that satisfies the following conditions for all  $a, b \in R$ .

- $\|a\| \geq 0$  and  $\|a\| = 0$  if and only if  $a = 0$ ; further  $\|1\| = \| -1\| = 1$
- There is an  $x \in R$  with  $0 < \|x\| < 1$
- $\|a \cdot b\| \leq \|a\| \cdot \|b\|$
- $\|a+b\| \leq \max\{\|a\|, \|b\|\}$

### 3 Neutrosophic Triplet Normed Ring Space

**Definition 3.1.** Let  $(\text{NTR}, *, \#)$  be a NT ring. If  $\|\cdot\| : \text{NTR} \rightarrow \mathbb{R}^+ \cup \{0\}$  function satisfies following condition;  $\|\cdot\|$  is called NT normed ring on  $(\text{NTR}, *, \#)$ . For  $x, y, z \in \text{NTR}$ ,

- $\|x\| \geq 0$ ;
- If  $x = \text{neut}_*(x)$ , then  $\|x\| = 0$ . Where,  $\text{neut}_*(x)$  is neutral of  $x$  with respect to  $*$ .
- There is a  $x \in \text{NTR}$  such that  $\|\text{neut}_*(x)\| \leq \|x\| \leq \|\text{neut}_\#(x)\|$ . Where,  $\text{neut}_\#(x)$  is neutral of  $x$  with respect to  $\#$  and  $\text{neut}_*(x)$  is neutral of  $x$  with respect to  $*$ .
- $\|\text{anti}_*(x)\| = \|x\|$ . Where,  $\text{anti}_*(x)$  is anti of  $x$  with respect to  $*$ .
- If there exists a element  $k \in \text{NTR}$  such that  $\|x \# y\| \leq \|x \# y \# \text{neut}_\#(k)\|$ ; then  $\|x \# y \# \text{neut}_\#(k)\| \leq \|x\| \cdot \|y\|$
- If there exists a element  $k \in \text{NTR}$  such that  $\|x * y\| \leq \|x * y * \text{neut}_*(k)\|$ ; then  $\|x * y * \text{neut}_*(k)\| \leq \max\{\|x\|, \|y\|\}$

Furthermore,  $((\text{NTR}, *, \#), \|\cdot\|)$  is called NT normed ring space.

**Example 3.2.** Let  $X = \{1, 2\}$ , and  $P(X)$  be power set of  $X$ . From Definition 2.4;  $(P(X), *, \cap)$  is a NT ring. Where,

$$A * B = \begin{cases} B \setminus A, & s(A) < s(B) \wedge B \supseteq A \wedge A' = B \\ A \setminus B, & s(A) > s(B) \wedge A \supseteq B \wedge B' = A \\ (A \setminus B)', & s(A) > s(B) \wedge A \supseteq B \wedge B' \neq A \\ (B \setminus A)', & s(A) < s(B) \wedge B \supseteq A \wedge A' \neq B \\ X, & s(A) = s(B) \wedge A \neq B \\ \emptyset, & A = B \end{cases}$$

The NT with respect to  $*$ ;

$$\begin{aligned} \text{neut}(\emptyset) &= \emptyset, \text{anti}(\emptyset) = \emptyset; \text{neut}(\{1\}) = \{1, 2\}, \\ \text{anti}(\{1\}) &= \{2\}; \text{neut}(\{2\}) = \{1, 2\}, \\ \text{anti}(\{2\}) &= \{1\}; \text{neut}(\{1, 2\}) = \emptyset, \text{anti}(\{1, 2\}) = \{1, 2\}; \end{aligned}$$

The NT with respect to  $\cap$ ;  $\text{neut}(A) = A$  and  $\text{anti}(A) = B$ . Where,  $B \supseteq A$  and  $s(A)$  is number of elements in  $A \in P(X)$  and  $A'$  is complement of  $A \in P(X)$ . Now we show that  $(P(X), *, \cap), \|\cdot\|$  is a NT normed ring space such that  $\|A\| = s(A)$ .

- $\|A\| = s(A) \geq 0$
- Since  $\text{neut}(\emptyset) = \emptyset$ ,  $\|\emptyset\| = s(\emptyset) = 0$
- For  $\emptyset \in P(X)$ ,  $\text{neut}_*(\emptyset) = \emptyset$ ,  $\text{neut}_\cap(\emptyset) = \emptyset$ ; then  $\|\text{neut}_*(x)\| \leq \|x\| \leq \|\text{neut}_\cap(x)\|$
- Since  $\text{anti}(\emptyset) = \emptyset$ ,  $\text{anti}(\{1\}) = \{2\}$ ,  $\text{anti}(\{2\}) = \{1\}$ ,  
 $\text{anti}(\{1, 2\}) = \{1, 2\}$ ;  
 $\|\emptyset\| = \|\emptyset\|$ ,  $\|\{1\}\| = \|\{2\}\|$ ,  $\|\{1, 2\}\| = \|\{1, 2\}\|$ . Thus;  $\|\text{anti}(A)\| = \|A\|$  for  $A \in P(X)$ .
- Since  $\text{neut}(\emptyset) = \emptyset$ ,  $\text{anti}(\emptyset) = \emptyset$ ;  
 $\text{neut}(\{1\}) = \{1, 2\}$ ,  $\text{anti}(\{1\}) = \{2\}$ ;  
 $\text{neut}(\{2\}) = \{1, 2\}$ ,  $\text{anti}(\{2\}) = \{1\}$ ;  
 $\text{neut}(\{1, 2\}) = \emptyset$ ,  $\text{anti}(\{1, 2\}) = \{1, 2\}$ ;

For  $\emptyset$  and  $\emptyset$ ;

$$|\emptyset * \emptyset| = |\emptyset| = 0 \leq |\emptyset * \emptyset * \text{neut}(\{1\})| = |\{1,2\}| = 2$$

Thus;  $|\emptyset * \emptyset| = 0 \leq |\emptyset| + |\emptyset| = 0$

For  $\emptyset$  and  $\{1\}$ ;

$$|\emptyset * \{1\}| = |\{2\}| = 1 \leq |\emptyset * \{1\} * \text{neut}(\{2\})| = |\{1\}| = 1. \text{ Thus; } |\emptyset * \{1\}| = 1 \leq |\emptyset| + |\{1\}| = 1$$

For  $\emptyset$  and  $\{2\}$ ;

$$|\emptyset * \{2\}| = |\{1\}| = 1 \leq |\emptyset * \{2\} * \text{neut}(\{1\})| = |\{2\}| = 1. \text{ Thus; } |\emptyset * \{2\}| = 1 \leq |\emptyset| + |\{2\}| = 1$$

For  $\emptyset$  and  $\{1,2\}$ ;

$$|\emptyset * \{1,2\}| = |\{1,2\}| = 2 \leq |\emptyset * \{1,2\} * \text{neut}(\{\emptyset\})| = |\{1,2\}| = 2.$$

Thus;  $|\emptyset * \{1,2\}| = 2 \leq |\emptyset| + |\{1,2\}| = 2$

For  $\{1\}$  and  $\{1\}$ ;

$$|\{1\} * \{1\}| = |\emptyset| = 0 \leq |\{1\} * \{1\} * \text{neut}(\{2\})| = |\{1,2\}| = 2.$$

Thus;  $|\{1\} * \{1\}| = 0 \leq |\{1\}| + |\{1\}| = 2$

For  $\{1\}$  and  $\{2\}$ ;

$$|\{1\} * \{2\}| = |\emptyset| = 0 \leq |\{1\} * \{2\} * \text{neut}(\{2\})| = |\{1,2\}| = 2.$$

Thus;  $|\{1\} * \{2\}| = 0 \leq |\{1\}| + |\{2\}| = 2$

For  $\{1\}$  and  $\{1,2\}$ ;

$$|\{1\} * \{1,2\}| = |\{2\}| = 1 \leq |\{1\} * \{1,2\} * \text{neut}(\{2\})| = |\{1\}| = 1.$$

Thus;  $|\{1\} * \{1,2\}| = 1 \leq |\{1\}| + |\{1,2\}| = 3$

For  $\{2\}$  and  $\{2\}$ ;

$$|\{2\} * \{2\}| = |\emptyset| = 0 \leq |\{2\} * \{2\} * \text{neut}(\{1\})| = |\{1,2\}| = 2.$$

Thus;  $|\{2\} * \{2\}| = 0 \leq |\{2\}| + |\{2\}| = 2$

For  $\{2\}$  and  $\{1,2\}$ ;  $|\{2\} * \{1,2\}| = |\{1\}| = 1 \leq |\{2\} * \{1,2\} * \text{neut}(\{1\})| = |\{2\}| = 1.$

Thus;  $|\{2\} * \{1,2\}| = 1 \leq |\{2\}| + |\{1,2\}| = 3$

f) Since  $A, B \in \mathcal{P}(X)$  and  $\text{neut}(\{1\}) = \{1, 2\} = X$ ;  $A \cap B \cap X = A \cap B$ . Thus;  $|A \cap B| = |A \cap B \cap \text{neut}(\{1\})|$ . Now we show that;

$$|A \cap B| = |A \cap B \cap \text{neut}(\{1\})| \leq \max\{|A|, |B|\}.$$

For  $\emptyset$  and  $\emptyset$ ;

$$|\emptyset \cap \emptyset| = 0 \leq \max\{|\emptyset|, |\emptyset|\} = 0$$

For  $\emptyset$  and  $\{1\}$ ;

$$|\emptyset \cap \{1\}| = 0 \leq \max\{|\emptyset|, |\{1\}|\} = 1$$

For  $\emptyset$  and  $\{2\}$ ;

$$|\emptyset \cap \{2\}| = 0 \leq \max\{|\emptyset|, |\{2\}|\} = 1$$

For  $\emptyset$  and  $\{1,2\}$ ;

$$|\emptyset \cap \{1,2\}| = 0 \leq \max\{|\emptyset|, |\{1,2\}|\} = 2$$

For  $\{1\}$  and  $\{1\}$ ;

$$|\{1\} \cap \{1\}| = 1 \leq \max\{|\{1\}|, |\{1\}|\} = 1$$

For  $\{1\}$  and  $\{2\}$ ;

$$|\{1\} \cap \{2\}| = 0 \leq \max\{|\{1\}|, |\{2\}|\} = 1$$

For  $\{1\}$  and  $\{1,2\}$ ;

$$|\{1\} \cap \{1,2\}| = 1 \leq \max\{|\{1\}|, |\{1,2\}|\} = 2$$



For  $\{2\}$  and  $\{2\}$ ;

$$I\{2\} \cap I\{2\} = 1 \leq \max\{I\{2\}, I\{2\}\} = 1$$

For  $\{2\}$  and  $\{1, 2\}$ ;

$$I\{2\} \cap I\{1,2\} = 0 \leq \max\{I\{2\}, I\{1,2\}\} = 2.$$

For  $\{1,2\}$  and  $\{1, 2\}$ ;  $I\{1,2\} \cap I\{1,2\} = 2$

$$\leq \max\{I\{1,2\}, I\{1,2\}\} = 2$$

Thus;  $(P(X), *, \cap, I, I)$  is a NT normed ring space.

**Corollary 3.3.** It is clear that NT normed ring spaces are generally different from classical normed ring spaces since for  $\text{neut}(x)$  different from classical unit element. However; if certain conditions are met; every classical normed space can be a NT normed space at the same time.

**Proposition 3.4.** Let  $(NTR, *, \#, \|\cdot\|)$  be a NT normed ring space.

a) If there exists a element  $k \in NTR$  such that

$$I x * y \leq I x * y * \text{neut}(k) \text{ and } \|x\| < \|y\| \text{ then } \|x * y\| = \|y\|.$$

b) If there exists a element  $k \in NTR$  such that  $I x * y \leq I x * y * \text{neut}(k)$  then  $\|x * y\| \leq \|x\| + \|y\|$ .

**Proof.**

a) From Definition 3.1, now that there exists a element  $k \in NTR$  such that

$I x * y \leq I x * y * \text{neut}(k)$ , it is clear that

$$I z \leq I z * \text{neut}(k) \text{ for } x * y = z, z \in NTR$$

(i)

Furthermore, from Definition 3.1, now that there exists a element  $k \in NTR$  such that

$$I x * y \leq I x * y * \text{neut}(k), I x * y \leq \max\{I x, I y\}.$$

For  $\|x\| < \|y\|$ , it is clear that  $I x * y * \text{neut}(k) \leq I y$ .

Assume that  $I x * y * \text{neut}(k) < I y$ .

From (i), we can take  $x = k$  such that  $I y \leq I y * \text{neut}(x)$ .

Thus;

$$\|x * y\| = \|y\|.$$

b) From definition 1, now that there exists a element  $k \in NTR$  such that

$$I x * y \leq I x * y * \text{neut}(k), \text{ it is clear that}$$

$$I x * y \leq \max\{I x, I y\}$$

(ii)

Furthermore,

$$\max\{I x, I y\} \leq I x + I y$$

(iii)

From (ii) and (iii), it is clear that,

$$\|x * y\| \leq \|x\| + \|y\|.$$

**Theorem 3.5.** Let  $(NTR, *, \#, \|\cdot\|)$  be a NT normed ring space. If  $\|\cdot\| : NTR \rightarrow \mathbb{R}^+ \cup \{0\}$  function and  $(NTR, *, \#, \|\cdot\|)$  satisfy following conditions; it is called NT normed space on  $(NTR, *, \#, \|\cdot\|)$ . For  $x, y, z \in NTR$ ,

a)  $(NTR, *, \#)$  be a NT vector space.

b)  $I x \# y = I x \cdot I y$

**Proof.**

Now that  $(NTR, *, \#)$  is a NT ring,

$a \# b \in NTR$ ; for all  $a, b \in NTR$ ;

$a \# (b \# c) = (a \# b) \# c$ ; for all  $a, b, c \in NTR$ ;

$a \# (b * c) = (a \# b) * (a \# c)$  and

$(b * c) \# a = (b \# a) * (c \# a)$ ; for all  $a, b, c \in NTR$ .

From a),  $(NTR, *, \#)$  is a NT vector space. Thus,  $(NTR, *, \#)$  be a NT field. Now we show that  $(NTR, *, \#, \|\cdot\|)$  is a NT normed space.

For  $x, y, k \in NTR$ ,

a) From Definition 3.1,  $I x \geq 0$

b) From Definition 3.1, if  $x = \text{neut}_*(x)$ , then  $I x = 0$

c) Now that  $(NTR, *, \#)$  is a NT field and from b),

$|x \# y| = |x| \cdot |y|$ . Then we can take

$f: NTR \times NTR \rightarrow \mathbb{R}^+ \cup \{0\}$ ,  $f(x, y) = |x|$ . Where, it is clear that  $f(x, y) = |x| = |anti_*(x)| = f(anti_*(x), anti_*(y))$ .

Thus;  $|x \# y| = f(x, y) \cdot |y|$

d) From Definition 3.1,  $|anti_*(x)| = |x|$

e) From Definition 3.1, and Proposition 3.4, it is clear that If there exists a element  $k \in NTR$  such that

$$|x * y| \leq |x * y * neut(k)|;$$

then

$$|x * y * neut(k)| \leq |x| + |y|.$$

Thus;  $(NTR, *, \#, \|\cdot\|)$  is a NT normed space.

**Proposition 3.6.** Let  $(NTR, *, \#, \|\cdot\|)$  be a NT normed ring space. If  $\|neut(x)\| = 0$ , for  $x \in NTR$ , then the function  $d: NTR \times NTR \rightarrow \mathbb{R}$  defined by  $d(x, y) = |x * anti(y)|$  provides NT metric space conditions.

**Proof.**

Let  $x, y, z \in NTR$ . From the Definition 3.1,

1)  $d(x, y) = \|x * anti(y)\| \geq 0$ ;

2) If  $x = y$  then;  $d(x, y) = \|x * anti(y)\| = \|y * anti(y)\| = \|neut(x)\| = \|neut(y)\|$ . Now that  $\|neut(x)\| = 0$ ,  $d(x, y) = 0$ .

3) Now that  $\|anti(x)\| = \|x\|$ , we have  $d(x, y) = \|x * anti(y)\| = \|anti(x * anti(y))\|$ . From the Theorem 2.2 and Theorem 2.5, we have

$$d(x, y) = \|anti(x * anti(y))\| = \|anti(x) * anti(anti(y))\| = \|anti(x) * y\| = d(y, x).$$

4) For any  $k \in NTV$ ; suppose that

$$d(x, z) = \|x * anti(z)\| \leq \|x * anti(z) * neut(k)\| =$$

$$d(x, z *_{2} neut(k)), \text{ then}$$

$$\|x * anti(z)\| \leq$$

$$\|x * anti(z) * neut(k)\| =$$

$$\|x * anti(z) * k * anti(k)\|.$$

Now that NTV is a commutative group with respect to “\*”, we have

$$\|x * anti(z) * k * anti(k)\| =$$

$$\|(x * anti(k)) * (anti(z) * k)\| \leq$$

$$\max\{\|x * anti(k)\|, \|k * anti(z)\|\} \leq$$

$$\|x * anti(k)\| + \|k * anti(z)\|.$$

Thus, if  $d(x, z) \leq d(x, z *_{2} neut(k))$ , then  $d(x, z *_{2} neut(k)) \leq d(x, k) + d(k, z)$ .

**Definition 3.7.** Let  $(NTR, *, \#, \|\cdot\|)$  be a NT normed ring space,  $\{x_n\}$  be a sequence in this space. For all  $\epsilon > 0$ , for all  $n \geq M$  such that

$$\|x * anti(x_n)\| < \epsilon$$

if there exists a  $M \in \mathbb{N}$ ;  $\{x_n\}$  sequence converges to  $x$ . It is denoted by

$$\lim_{n \rightarrow \infty} x_n = x \text{ or } x_n \rightarrow x$$

**Definition 3.8.** Let  $(NTR, *, \#, \|\cdot\|)$  be a NT normed ring space,  $\{x_n\}$  be a sequence in this space. For all  $\epsilon > 0$  such that for all  $n, m \geq M$

$$\|x_n * anti(\{x_m\})\| < \epsilon$$

If there exists a  $M \in \mathbb{N}$ , then  $\{x_n\}$  sequence is called Cauchy sequence.

**Definition 3.9.** Let  $(NTR, *, \#, \|\cdot\|)$  be a NT normed ring space,  $\{x_n\}$  be a sequence in this space. If each  $\{x_n\}$  Cauchy sequence in this space is convergent to d reduced NT metric;  $(NTR, *, \#, \|\cdot\|)$  is called complete NT normed ring space.

**Theorem 3.10.** Let  $(NTR, *, \#, \|\cdot\|)$  be a NT normed ring space,  $\{x_n\}$  be a sequence in this space. If there exist a  $M \in \mathbb{N}$  such that  $\|x_m * anti(\{x_{m+1}\})\| < \epsilon$  for all  $n, m \geq M$  and there exist a  $k \in NTR$  such that  $|x * y| \leq |x * y * neut(k)|$ , then  $\{x_n\}$  is a Cauchy sequence.

**Proof.**

Let  $n > m \geq M$ . From Definition 3.1, now that there exist a  $k \in NTR$  such that

$$|x * y| \leq |x * y * neut(k)|,$$

$$\|x_n * anti(x_m)\| < \|x_n * anti(\{x_m\}) * neut(x_{n-1})\| \tag{iv}$$

Thus, from definition 3.1,

$$\|x_n * anti(x_m)\| <$$

$$\|x_n * anti(\{x_m\}) * neut(x_{n-1})\| =$$

$$\|x_n * \text{anti}(x_m) * (x_{n-1}) * \text{anti}(x_{n-1})\| \leq \max\{\|x_n * \text{anti}(x_{n-1})\|, \|x_{n-1} * \text{anti}(x_m)\|\}.$$

Similarly from (iv),

$$\text{for } \|x_{n-1} * \text{anti}(x_m)\|;$$

$$\|(x_{n-1}) * \text{anti}(x_m)\| \leq \max\{\|x_{n-1} * \text{anti}(x_{n-2})\|, \|x_{n-2} * \text{anti}(x_m)\|\}$$

⋮

$$\text{for } \|x_{m+2} * \text{anti}(x_m)\|;$$

$$\|(x_{m+2}) * \text{anti}(x_m)\| \leq \max\{\|x_{m+2} * \text{anti}(x_{m+1})\|, \|x_{m+1} * \text{anti}(x_m)\|\}.$$
 Thus,
$$\|x_n * \text{anti}(x_m)\| \leq$$

$$\max\{\|x_{n-1} * \text{anti}(x_{n-2})\|, \|x_{n-2} * \text{anti}(x_{n-3})\|, \dots, \|x_{m+1} * \text{anti}(x_m)\|\}$$

and now that  $\|x_m * \text{anti}(\{x_{m+1}\})\| < \varepsilon$ , it is clear that  $\|x_n * \text{anti}(x_m)\| < \varepsilon$ . Therefore;  $\{x_n\}$  is a Cauchy sequence.

## 4 Conclusion

In this paper; we introduced NT normed ring space. We also show that NT normed ring different from the classical one. This NT notion has several extraordinary properties compared to the classical one. We also studied some interesting properties of this newly born structure. We give rise to a new field or research called NT structures.

## References

- [1] Smarandache F. A Unifying Field in logics, Neutrosophy: Neutrosophic Probability, Set and Logic. American Research Press: Rehoboth, MA, USA, 1998
- [2] L. A. Zadeh, "Fuzzy sets." Information and control, 8(3) (1965), 338-353,
- [3] T. K. Atanassov, Intuitionistic fuzzy sets, Fuzzy Sets Syst, 20 (1986), 87-96
- [4] W. B. V. Kandasamy, F. Smarandache, Basic neutrosophic algebraic structures and their applications to fuzzy and neutrosophic models, Hexis, Frontigan, USA, (2004)
- [5] Kandasamy W. B. V., Smarandache F. Some neutrosophic algebraic structures and neutrosophic n-algebraic structures. Hexis: Phoenix, AZ, USA, (2006)
- [6] S. Broumi, A. Bakali, M. Talea, F. Smarandache and L. Vladareanu, Computation of Shortest Path Problem in a Network with SV-Trapezoidal Neutrosophic Numbers, Proceedings of the 2016 International Conference on Advanced Mechatronic Systems, Melbourne, Australia, (2016) pp.417-422.
- [7] S. Broumi, A. Bakali, M. Talea, F. Smarandache and L. Vladareanu, (Applying Dijkstra Algorithm for Solving Neutrosophic Shortest Path Problem, Proceedings of the 2016 International Conference on Advanced Mechatronic Systems, Melbourne, Australia (November 30 - December 3, 2016) pp. 412-416.
- [8] Liu P. and Shi L., The Generalized Hybrid Weighted Average Operator Based on Interval Neutrosophic Hesitant Set and Its Application to Multiple Attribute Decision Making, Neural Computing and Applications (2015) 26(2): 457-471
- [9] P. Liu and L. Shi, Some Neutrosophic Uncertain Linguistic Number Heronian Mean Operators and Their Application to Multi-attribute Group Decision making, Neural Computing and Applications (2015) doi:10.1007/s00521-015-2122-6
- [10] P. Liu, G. Tang, Some power generalized aggregation operators based on the interval neutrosophic numbers and their application to decision making, Journal of Intelligent & Fuzzy Systems 30 (2016), 2517-2528
- [11] P. Liu and G. Tang, Multi-criteria group decision-making based on interval neutrosophic uncertain linguistic variables and Choquet integral, Cognitive Computation, 8(6) (2016), 1036-1056
- [12] P. Liu and Y. Wang, Interval neutrosophic prioritized OWA operator and its application to multiple attribute decision making, journal of systems science & complexity, 29(3) (2016), 681-697
- [13] P. Liu, F. Teng, Multiple attribute decision making method based on normal neutrosophic generalized weighted power averaging operator, internal journal of machine learning and cybernetics, (2015) 10.1007/s13042-015-0385-y
- [14] P. Liu, L. Zhang, X. Liu, and P. Wang, Multi-valued Neutrosophic Number Bonferroni mean Operators and Their Application in Multiple Attribute Group Decision Making, internal journal of information technology & decision making, 15(5) (2016) , 1181-1210
- [15] M. Sahin, and A. Kargin, Neutrosophic triplet metric space and neutrosophic triplet normed space, ICMME -2017, Şanlıurfa, Turkey
- [16] M. Sahin, I. Deli, and V. Ulucay, Jaccard vector similarity measure of bipolar neutrosophic set based on multi-criteria decision making. In: International conference on natural science and engineering (ICNASE'16), (2016) March 19-20, Kilis, Turkey
- [17] M. Sahin, I. Deli, and V. Ulucay, Similarity measure of bipolar neutrosophic sets and their application to

- multiple criteria decision making, *Neural Comput & Applic.* (2016), DOI 10.1007/S00521
- [18] C. Liu and Y. Luo, Power aggregation operators of simplified neutrosophic sets and their use in multi-attribute group decision making, *IEEE/CAA Journal of Automatica Sinica*, (2017), DOI: 10.1109/JAS.2017.7510424
- [19] R. Şahin and P. Liu, Some approaches to multi criteria decision making based on exponential operations of simplified neutrosophic numbers, *Journal of Intelligent & Fuzzy Systems*, 32(3) (2017), 2083-2099, DOI: 10.3233/JIFS-161695
- [20] P. Liu and H. Li, Multi attribute decision-making method based on some normal neutrosophic Bonferroni mean operators, *Neural Computing and Applications*, 28(1) (2017), 179-194, DOI 10.1007/s00521-015-2048-z
- [21] M. Şahin, N. Olgun, V. Uluçay, A. Kargın, and F. Smarandache, A new similarity measure on falsity value between single valued neutrosophic sets based on the centroid points of transformed single valued neutrosophic numbers with applications to pattern recognition, *Neutrosophic Sets and Systems*, 15 (2017), 31-48, doi: org/10.5281/zenodo570934
- [22] M. Şahin, O. Ecemiş, V. Uluçay, and A. Kargın, Some new generalized aggregation operators based on centroid single valued triangular neutrosophic numbers and their applications in multi-attribute decision making, *Asian Journal of Mathematics and Computer Research*, 16(2) (2017), 63-84
- [23] S. Broumi, A. Bakali, M. Talea, F. Smarandache, Single Valued Neutrosophic Graphs: Degree, Order and Size. *IEEE International Conference on Fuzzy Systems*, (2016), 2444-2451.
- [24] S. Broumi, A. Bakali, M. Talea and F. Smarandache, Decision-Making Method Based On the Interval Valued Neutrosophic Graph, *Future Technologic*, IEEE, (2016), 44-50.
- [25] P. Liu, The aggregation operators based on Archimedean t-conorm and t-norm for the single valued neutrosophic numbers and their application to Decision Making, *International Journal of Fuzzy Systems*, 18(5) (2016), 849-863
- [26] F. Smarandache and M. Ali, Neutrosophic triplet as extension of matter plasma, unmatter plasma and anti-matter plasma, *APS Gaseous Electronics Conference*, (2016) doi: 10.1103/BAPS.2016.GEC.HT6.110
- [27] F. Smarandache and M. Ali, The Neutrosophic Triplet Group and its Application to Physics, presented by F. S. to Universidad Nacional de Quilmes, Department of Science and Technology, Bernal, Buenos Aires, Argentina (02 June 2014)
- [28] F. Smarandache and M. Ali, Neutrosophic triplet group. *Neural Computing and Applications*, 29 (2016) , 595-601.
- [29] F. Smarandache F. and M. Ali, Neutrosophic Triplet Field Used in Physical Applications, (Log Number: NWS17-2017-000061), 18th Annual Meeting of the APS Northwest Section, Pacific University, Forest Grove, OR, USA (June, 2017) <http://meetings.aps.org/Meeting/NWS17/Session/D1.1>
- [30] F. Smarandache and M. Ali, Neutrosophic Triplet Ring and its Applications, (Log Number: NWS17-2017-000062), 18th Annual Meeting of the APS Northwest Section, Pacific University, Forest Grove, OR, USA (June, 2017). <http://meetings.aps.org/Meeting/NWS17/Session/D1.2>
- [31] M. Şahin and A. Kargın, Neutrosophic triplet normed space, *Open Physics*, 15 (2017), 697-704
- [32] M. Şahin and A. Kargın, Neutrosophic triplet inner product space, *Neutrosophic Operational Research*, 2 (2017), 193-215,
- [33] G. Shilov, On decomposition of a commutative normed ring in a direct sum of ideals, *Mat Sb.*, 74(2) (1953), 353 – 364
- [34] M. Jarden, *Normed rings*, Springer – Verlag Berlin Heidelberg, (2011), DOI: 10.1007/978-3-642-15128-6
- [35] V. Uluçay, M. Şahin, and N. Olgun, *Soft normed ring*, SpringerPlus, (2016), DOI:10.1186/s40064-016-3636-9

Received: June 11, 2018. Accepted: July 6, 2018.



# On Neutrosophic Crisp Semi Alpha Closed Sets

Riad K. Al-Hamido<sup>1</sup>, Qays Hatem Imran<sup>2</sup>, Karem A. Alghurabi<sup>3</sup> and Taleb Gharibah<sup>4</sup>

<sup>1,4</sup>Department of Mathematics, College of Science, Al-Baath University, Homs, Syria.

E-mail: [riad-hamido1983@hotmail.com](mailto:riad-hamido1983@hotmail.com)

E-mail: [taleb.gharibah@gmail.com](mailto:taleb.gharibah@gmail.com)

<sup>2</sup>Department of Mathematics, College of Education for Pure Science, Al Muthanna University, Samawah, Iraq.

E-mail: [qays.imran@mu.edu.iq](mailto:qays.imran@mu.edu.iq)

<sup>3</sup>Department of Mathematics, College of Education for Pure Science, Babylon University, Hilla, Iraq.

E-mail: [kareemalghurabi@yahoo.com](mailto:kareemalghurabi@yahoo.com)

**Abstract.** In this paper, we presented another concept of neutrosophic crisp generalized closed sets called neutrosophic crisp semi- $\alpha$ -closed sets and studied their fundamental properties in neutrosophic crisp topological spaces. We also present neutrosophic crisp semi- $\alpha$ -closure and neutrosophic crisp semi- $\alpha$ -interior and study some of their fundamental properties.

**Mathematics Subject Classification (2000):** 54A40, 03E72.

**Keywords:** Neutrosophic crisp semi- $\alpha$ -closed sets, neutrosophic crisp semi- $\alpha$ -open sets, neutrosophic crisp semi- $\alpha$ -closure and neutrosophic crisp semi- $\alpha$ -interior.

## 1. Introduction

The concept of "neutrosophic set" was first given by F. Smarandache [4,5]. A. A. Salama and S. A. Alblowi [1] presented the concept of neutrosophic topological space (briefly NTS). Q. H. Imran, F. Smarandache, R. K. Al-Hamido and R. Dhavaseelan [6] presented the idea of neutrosophic semi- $\alpha$ -open sets in neutrosophic topological spaces. In 2014, A. A. Salama, F. Smarandache and V. Kroumov [2] presented the concept of neutrosophic crisp topological space (briefly NCTS). The objective of this paper is to present the concept of neutrosophic crisp semi- $\alpha$ -closed sets and study their fundamental properties in neutrosophic crisp topological spaces. We also present neutrosophic crisp semi- $\alpha$ -closure and neutrosophic crisp semi- $\alpha$ -interior and obtain some of its properties.

## 2. Preliminaries

Throughout this paper,  $(\mathcal{U}, T)$  (or simply  $\mathcal{U}$ ) always mean a neutrosophic crisp topological space. The complement of a neutrosophic crisp open set (briefly NC-OS) is called a neutrosophic crisp closed set (briefly NC-CS) in  $(\mathcal{U}, T)$ . For a neutrosophic crisp set  $\mathcal{A}$  in a neutrosophic crisp topological space  $(\mathcal{U}, T)$ ,  $NCcl(\mathcal{A})$ ,  $NCint(\mathcal{A})$  and  $\mathcal{A}^c$  denote the neutrosophic crisp closure of  $\mathcal{A}$ , the neutrosophic crisp interior of  $\mathcal{A}$  and the neutrosophic crisp complement of  $\mathcal{A}$ , respectively.

### Definition 2.1:

A neutrosophic crisp subset  $\mathcal{A}$  of a neutrosophic crisp topological space  $(\mathcal{U}, T)$  is said to be:

(i) A neutrosophic crisp pre-open set (briefly NCP-OS) [3] if  $\mathcal{A} \subseteq NCint(NCcl(\mathcal{A}))$ . The complement of a NCP-OS is called a neutrosophic crisp pre-closed set (briefly NCP-CS) in  $(\mathcal{U}, T)$ . The family of all NCP-OS (resp. NCP-CS) of  $\mathcal{U}$  is denoted by  $NCPO(\mathcal{U})$  (resp.  $NCPC(\mathcal{U})$ ).

(ii) A neutrosophic crisp semi-open set (briefly NCS-OS) [3] if  $\mathcal{A} \subseteq NCcl(NCint(\mathcal{A}))$ . The complement of a NCS-OS is called a neutrosophic crisp semi-closed set (briefly NCS-CS) in  $(\mathcal{U}, T)$ . The family of all NCS-OS (resp. NCS-CS) of  $\mathcal{U}$  is denoted by  $NCSO(\mathcal{U})$  (resp.  $NCSC(\mathcal{U})$ ).

(iii) A neutrosophic crisp  $\alpha$ -open set (briefly  $NC\alpha$ -OS) [3] if  $\mathcal{A} \subseteq NCint(NCcl(NCint(\mathcal{A})))$ . The complement of a  $NC\alpha$ -OS is called a neutrosophic crisp  $\alpha$ -closed set (briefly  $NC\alpha$ -CS) in  $(\mathcal{U}, T)$ . The family of all  $NC\alpha$ -OS (resp.  $NC\alpha$ -CS) of  $\mathcal{U}$  is denoted by  $NC\alpha O(\mathcal{U})$  (resp.  $NC\alpha C(\mathcal{U})$ ).

### Definition 2.2:

(i) The neutrosophic crisp pre-interior of a neutrosophic crisp set  $\mathcal{A}$  of a neutrosophic crisp topological space  $(\mathcal{U}, T)$  is the union of all NCP-OS contained in  $\mathcal{A}$  and is denoted by  $PNCint(\mathcal{A})$ [3].

- (ii) The neutrosophic crisp semi-interior of a neutrosophic crisp set  $\mathcal{A}$  of a neutrosophic crisp topological space  $(\mathcal{U}, T)$  is the union of all NCS-OS contained in  $\mathcal{A}$  and is denoted by  $SNCint(\mathcal{A})$ [3].
- (iii) The neutrosophic crisp  $\alpha$ -interior of a neutrosophic crisp set  $\mathcal{A}$  of a neutrosophic crisp topological space  $(\mathcal{U}, T)$  is the union of all  $NC\alpha$ -OS contained in  $\mathcal{A}$  and is denoted by  $\alpha NCint(\mathcal{A})$ [3].

**Definition 2.3:**

- (i) The neutrosophic crisp pre-closure of a neutrosophic crisp set  $\mathcal{A}$  of a neutrosophic crisp topological space  $(\mathcal{U}, T)$  is the intersection of all NCP-CS that contain  $\mathcal{A}$  and is denoted by  $PNCcl(\mathcal{A})$ [3].
- (ii) The neutrosophic crisp semi-closure of a neutrosophic crisp set  $\mathcal{A}$  of a neutrosophic crisp topological space  $(\mathcal{U}, T)$  is the intersection of all NCS-CS that contain  $\mathcal{A}$  and is denoted by  $SNCcl(\mathcal{A})$ [3].
- (iii) The neutrosophic crisp  $\alpha$ -closure of a neutrosophic crisp set  $\mathcal{A}$  of a neutrosophic crisp topological space  $(\mathcal{U}, T)$  is the intersection of all  $NC\alpha$ -CS that contain  $\mathcal{A}$  and is denoted by  $\alpha NCcl(\mathcal{A})$ [3].

**Proposition 2.4 [7]:**

In a neutrosophic crisp topological space  $(\mathcal{U}, T)$ , the following statements hold, and the equality of each statement are not true:

- (i) Every NC-CS (resp. NC-OS) is a  $NC\alpha$ -CS (resp.  $NC\alpha$ -OS).
- (ii) Every  $NC\alpha$ -CS (resp.  $NC\alpha$ -OS) is a NCS-CS (resp. NCS-OS).
- (iii) Every  $NC\alpha$ -CS (resp.  $NC\alpha$ -OS) is a NCP-CS (resp. NCP-OS).

**Proposition 2.5 [7]:**

A neutrosophic crisp subset  $\mathcal{A}$  of a neutrosophic crisp topological space  $(\mathcal{U}, T)$  is a  $NC\alpha$ -CS (resp.  $NC\alpha$ -OS) iff  $\mathcal{A}$  is a NCS-CS (resp. NCS-OS) and NCP-CS (resp. NCP-OS).

**Theorem 2.6 [7]:**

For any neutrosophic crisp subset  $\mathcal{A}$  of a neutrosophic crisp topological space  $(\mathcal{U}, T)$ ,  $\mathcal{A} \in NC\alpha O(\mathcal{U})$  iff there exists a NC-OS  $\mathcal{H}$  such that  $\mathcal{H} \subseteq \mathcal{A} \subseteq NCint(NCcl(\mathcal{H}))$ .

**Proposition 2.7 [7]:**

The union of any family of  $NC\alpha$ -OS is a  $NC\alpha$ -OS.

**Proposition 2.8:**

- (i) If  $\mathcal{K}$  is a NC-OS, then  $SNCcl(\mathcal{K}) = NCint(NCcl(\mathcal{K}))$ .
- (ii) If  $\mathcal{A}$  is a neutrosophic crisp subset of a neutrosophic crisp topological space  $(\mathcal{U}, T)$ , then  $SNCint(NCcl(\mathcal{A})) = NCcl(NCint(NCcl(\mathcal{A})))$ .

**Proof:** This follows directly from the definition (2.1) and proposition (2.4).

**3. Neutrosophic Crisp Semi- $\alpha$ -Closed Sets**

In this section, we present and study the neutrosophic crisp semi- $\alpha$ -closed sets and some of its properties.

**Definition 3.1:**

A neutrosophic crisp subset  $\mathcal{A}$  of a neutrosophic crisp topological space  $(\mathcal{U}, T)$  is called neutrosophic crisp semi- $\alpha$ -closed set (briefly NCS $\alpha$ -CS) if there exists a  $NC\alpha$ -CS  $\mathcal{H}$  in  $\mathcal{U}$  such that  $NCint(\mathcal{H}) \subseteq \mathcal{A} \subseteq \mathcal{H}$  or equivalently if  $NCint(\alpha NCcl(\mathcal{A})) \subseteq \mathcal{A}$ . The family of all NCS $\alpha$ -CS of  $\mathcal{U}$  is denoted by  $NCS\alpha C(\mathcal{U})$ .

**Definition 3.2:**

A neutrosophic crisp set  $\mathcal{A}$  is called a neutrosophic crisp semi- $\alpha$ -open set (briefly NCS $\alpha$ -OS) if and only if its complement  $\mathcal{A}^c$  is a NCS $\alpha$ -CS or equivalently if there exists a  $NC\alpha$ -OS  $\mathcal{H}$  in  $\mathcal{U}$  such that  $\mathcal{H} \subseteq \mathcal{A} \subseteq NCcl(\mathcal{H})$ . The family of all NCS $\alpha$ -OS of  $\mathcal{U}$  is denoted by  $NCS\alpha O(\mathcal{U})$ .

**Proposition 3.3:**

It is evident by definitions that in a neutrosophic crisp topological space  $(\mathcal{U}, T)$ , the following hold:

- (i) Every NC-CS (resp. NC-OS) is a NCS $\alpha$ -CS (resp. NCS $\alpha$ -OS).
- (ii) Every  $NC\alpha$ -CS (resp.  $NC\alpha$ -OS) is a NCS $\alpha$ -CS (resp. NCS $\alpha$ -OS).

The converse of Proposition (3.3) need not be true as shown by the following example.

**Example 3.4:**

Let  $\mathcal{U} = \{p, q, r, s\}$ ,  $\mathcal{A} = \{\{p\}, \{q, s\}, \{r\}\}$ ,  $\mathcal{B} = \{\{p\}, \{q\}, \{r\}\}$ . Then  $T = \{\emptyset_N, \mathcal{A}, \mathcal{B}, \mathcal{U}_N\}$  is a neutrosophic crisp topology on  $\mathcal{U}$ .

- (i) Let  $\mathcal{H} = \langle \{p\}, \{q, r, s\}, \emptyset \rangle$ ,  $\mathcal{A} \subseteq \mathcal{H} \subseteq NCcl(\mathcal{A}) = \mathcal{U}_N$ , the neutrosophic crisp set  $\mathcal{H}$  is a NCS $\alpha$ -OS but not NC-OS. It is clear that  $\mathcal{H}^c = \langle \{q, r, s\}, \{p\}, \mathcal{U} \rangle$  is a NCS $\alpha$ -CS but not NC-CS.
- (ii) Let  $\mathcal{K} = \langle \emptyset, \{q, r, s\}, \{r, s\} \rangle$  and so  $\mathcal{K} \notin NCint(NCcl(NCint(\mathcal{K})))$ , the neutrosophic crisp set  $\mathcal{K}$  is a NCS $\alpha$ -OS but not NC $\alpha$ -OS. It is clear that  $\mathcal{K}^c = \langle \mathcal{U}, \{p\}, \{p, q\} \rangle$  is a NCS $\alpha$ -CS but not NC $\alpha$ -CS.

**Remark 3.5:**

The concepts of NCS $\alpha$ -CS (resp. NCS $\alpha$ -OS) and NCP-CS (resp. NCP-OS) are independent, as the following examples show.

**Example 3.6:**

Let  $\mathcal{U} = \{p, q, r, s\}$ ,  $\mathcal{A} = \langle \{p\}, \{q\}, \{r\} \rangle$ ,  $\mathcal{B} = \langle \{r\}, \{q\}, \{s\} \rangle$ ,  $\mathcal{C} = \langle \{p, r\}, \{q\}, \emptyset \rangle$ ,  $\mathcal{D} = \langle \emptyset, \{q\}, \{r, s\} \rangle$ . Then  $T = \{\emptyset_N, \mathcal{A}, \mathcal{B}, \mathcal{C}, \mathcal{D}, \mathcal{U}_N\}$  is a neutrosophic crisp topology on  $\mathcal{U}$ . Let  $\mathcal{H} = \langle \{r, s\}, \{p, q\}, \{s\} \rangle$ ,  $\mathcal{B} \subseteq \mathcal{H} \subseteq NCcl(\mathcal{B}) = \langle \{r, s\}, \{q\}, \emptyset \rangle$ , the neutrosophic crisp set  $\mathcal{H}$  is a NCS $\alpha$ -OS but not NCP-OS. It is clear that  $\mathcal{H}^c = \langle \{s\}, \{p, q\}, \{r, s\} \rangle$  is a NCS $\alpha$ -CS but not NCP-CS.

**Example 3.7:**

Let  $\mathcal{U} = \{p, q, r, s\}$ ,  $\mathcal{A}_1 = \langle \{p\}, \{q\}, \{r\} \rangle$ ,  $\mathcal{A}_2 = \langle \{p\}, \{q, s\}, \{r\} \rangle$ . Then  $T = \{\emptyset_N, \mathcal{A}_1, \mathcal{A}_2, \mathcal{U}_N\}$  is a neutrosophic crisp topology on  $\mathcal{U}$ . If  $\mathcal{A}_3 = \langle \{p, q\}, \{r\}, \{s\} \rangle$ , then  $\mathcal{A}_3$  is a NCP-OS but not NCS $\alpha$ -OS. It is clear that  $\mathcal{A}_3^c = \langle \{s\}, \{r\}, \{p, q\} \rangle$  is a NCP-CS but not NCS $\alpha$ -CS.

**Remark 3.8:**

- (i) If every NC-OS is a NC-CS and every nowhere neutrosophic crisp dense set is NC-CS in any neutrosophic crisp topological space  $(\mathcal{U}, T)$ , then every NCS $\alpha$ -CS (resp. NCS $\alpha$ -OS) is a NC-CS (resp. NC-OS).
- (ii) If every NC-OS is a NC-CS in any neutrosophic crisp topological space  $(\mathcal{U}, T)$ , then every NCS $\alpha$ -CS (resp. NCS $\alpha$ -OS) is a NC $\alpha$ -CS (resp. NC $\alpha$ -OS).

**Remark 3.9:**

- (i) It is clear that every NCS-CS (resp. NCS-OS) and NCP-CS (resp. NCP-OS) of any neutrosophic crisp topological space  $(\mathcal{U}, T)$  is a NCS $\alpha$ -CS (resp. NCS $\alpha$ -OS) (by Proposition (2.5) and Proposition (3.3) (ii)).
- (ii) A NCS $\alpha$ -CS (resp. NCS $\alpha$ -OS) in any neutrosophic crisp topological space  $(\mathcal{U}, T)$  is a NCP-CS (resp. NCP-OS) if every NC-OS of  $\mathcal{U}$  is a NC-CS (from Proposition (2.4) (iii) and Remark (3.8) (ii)).

**Theorem 3.10:**

For any neutrosophic crisp subset  $\mathcal{A}$  of a neutrosophic crisp topological space  $(\mathcal{U}, T)$ . The following properties are equivalent:

- (i)  $\mathcal{A} \in NCS\alpha O(\mathcal{U})$ .
- (ii) There exists a NC-OS, say  $\mathcal{H}$ , such that  $\mathcal{H} \subseteq \mathcal{A} \subseteq NCcl(NCint(NCcl(\mathcal{H})))$ .
- (iii)  $\mathcal{A} \subseteq NCcl(NCint(NCcl(NCint(\mathcal{A}))))$ .

**Proof:**

(i)  $\Rightarrow$  (ii) Let  $\mathcal{A} \in NCS\alpha O(\mathcal{U})$ . Then, there exists  $\mathcal{K} \in NC\alpha O(\mathcal{U})$ , such that  $\mathcal{K} \subseteq \mathcal{A} \subseteq NCcl(\mathcal{K})$ . Hence there exists  $\mathcal{H}$  NC-OS such that  $\mathcal{H} \subseteq \mathcal{K} \subseteq NCint(NCcl(\mathcal{H}))$  (by Theorem (2.6)). Therefore,  $NCcl(\mathcal{H}) \subseteq NCcl(\mathcal{K}) \subseteq NCcl(NCint(NCcl(\mathcal{H})))$ , implies that  $NCcl(\mathcal{K}) \subseteq NCcl(NCint(NCcl(\mathcal{H})))$ . Then  $\mathcal{H} \subseteq \mathcal{K} \subseteq \mathcal{A} \subseteq NCcl(\mathcal{K}) \subseteq NCcl(NCint(NCcl(\mathcal{H})))$ . Hence,  $\mathcal{H} \subseteq \mathcal{A} \subseteq NCcl(NCint(NCcl(\mathcal{H})))$ , for some  $\mathcal{H}$  NC-OS.

(ii)  $\Rightarrow$  (iii) Suppose that there exists a NC-OS  $\mathcal{H}$  such that  $\mathcal{H} \subseteq \mathcal{A} \subseteq NCcl(NCint(NCcl(\mathcal{H})))$ . We know that  $NCint(\mathcal{A}) \subseteq \mathcal{A}$ . On the other hand,  $\mathcal{H} \subseteq NCint(\mathcal{A})$  (since  $NCint(\mathcal{A})$  is the largest NC-OS contained in  $\mathcal{A}$ ). Hence  $NCcl(\mathcal{H}) \subseteq NCcl(NCint(\mathcal{A}))$ , then  $NCint(NCcl(\mathcal{H})) \subseteq NCint(NCcl(NCint(\mathcal{A})))$ , therefore  $NCcl(NCint(NCcl(\mathcal{H}))) \subseteq NCcl(NCint(NCcl(NCint(\mathcal{A}))))$ . But  $\mathcal{A} \subseteq NCcl(NCint(NCcl(\mathcal{H})))$  (by hypothesis). Hence  $\mathcal{A} \subseteq NCcl(NCint(NCcl(\mathcal{H}))) \subseteq NCcl(NCint(NCcl(NCint(\mathcal{A}))))$ , then  $\mathcal{A} \subseteq NCcl(NCint(NCcl(NCint(\mathcal{A}))))$ .

(iii)  $\Rightarrow$  (i) Let  $\mathcal{A} \subseteq NCcl(NCint(NCcl(NCint(\mathcal{A}))))$ . To prove  $\mathcal{A} \in NCS\alpha O(\mathcal{U})$ , let  $\mathcal{K} = NCint(\mathcal{A})$ ; we know that  $NCint(\mathcal{A}) \subseteq \mathcal{A}$ . To prove  $\mathcal{A} \subseteq NCcl(NCint(\mathcal{A}))$ .

Since  $NCint(NCcl(NCint(\mathcal{A}))) \subseteq NCcl(NCint(\mathcal{A}))$ .

Hence,  $NCcl(NCint(NCcl(NCint(\mathcal{A})))) \subseteq NCcl(NCcl(NCint(\mathcal{A}))) = NCcl(NCint(\mathcal{A}))$ .

But  $\mathcal{A} \subseteq NCcl(NCint(NCcl(NCint(\mathcal{A}))))$  (by hypothesis). Hence,  $\mathcal{A} \subseteq NCcl(NCint(NCcl(NCint(\mathcal{A}))))$

$\subseteq NCcl(NCint(\mathcal{A})) \Rightarrow \mathcal{A} \subseteq NCcl(NCint(\mathcal{A}))$ . Hence, there exists an NC-OS say  $\mathcal{K}$ , such that  $\mathcal{K} \subseteq \mathcal{A} \subseteq NCcl(\mathcal{A})$ . On the other hand,  $\mathcal{K}$  is a NC $\alpha$ -OS (since  $\mathcal{K}$  is a NC-OS). Hence  $\mathcal{A} \in NCS\alpha O(\mathcal{U})$ .

**Corollary 3.11:**

For any neutrosophic crisp subset  $\mathcal{A}$  of a neutrosophic crisp topological space  $(\mathcal{U}, T)$ , the following properties are equivalent:

- (i)  $\mathcal{A} \in \text{NCS}\alpha\text{C}(\mathcal{U})$ .
- (ii) There exists a NC-CS  $\mathcal{F}$  such that  $\text{NCint}(\text{NCcl}(\text{NCint}(\mathcal{F}))) \subseteq \mathcal{A} \subseteq \mathcal{F}$ .
- (iii)  $\text{NCint}(\text{NCcl}(\text{NCint}(\text{NCcl}(\mathcal{A})))) \subseteq \mathcal{A}$ .

**Proof:**

(i)  $\Rightarrow$  (ii) Let  $\mathcal{A} \in \text{NCS}\alpha\text{C}(\mathcal{U})$ , then  $\mathcal{A}^c \in \text{NCS}\alpha\text{O}(\mathcal{U})$ . Hence there is  $\mathcal{H}$  NC-OS such that  $\mathcal{H} \subseteq \mathcal{A}^c \subseteq \text{NCcl}(\text{NCint}(\text{NCcl}(\mathcal{H})))$  (by Theorem (3.10)). Hence  $(\text{NCcl}(\text{NCint}(\text{NCcl}(\mathcal{H}))))^c \subseteq \mathcal{A}^c \subseteq \mathcal{H}^c$ , i.e.,  $\text{NCint}(\text{NCcl}(\text{NCint}(\mathcal{H}^c))) \subseteq \mathcal{A} \subseteq \mathcal{H}^c$ . Let  $\mathcal{H}^c = \mathcal{F}$ , where  $\mathcal{F}$  is a NC-CS in  $\mathcal{U}$ .

Then  $\text{NCint}(\text{NCcl}(\text{NCint}(\mathcal{F}))) \subseteq \mathcal{A} \subseteq \mathcal{F}$ , for some  $\mathcal{F}$  NC-CS.

(ii)  $\Rightarrow$  (iii) Suppose that there exists  $\mathcal{F}$  NC-CS such that  $\text{NCint}(\text{NCcl}(\text{NCint}(\mathcal{F}))) \subseteq \mathcal{A} \subseteq \mathcal{F}$ , but  $\text{NCcl}(\mathcal{A})$  is the smallest NC-CS containing  $\mathcal{A}$ . Then  $\text{NCcl}(\mathcal{A}) \subseteq \mathcal{F}$ , and therefore:  $\text{NCint}(\text{NCcl}(\mathcal{A})) \subseteq \text{NCint}(\mathcal{F})$

$\Rightarrow \text{NCcl}(\text{NCint}(\text{NCcl}(\mathcal{A}))) \subseteq \text{NCcl}(\text{NCint}(\mathcal{F})) \Rightarrow \text{NCint}(\text{NCcl}(\text{NCint}(\text{NCcl}(\mathcal{A})))) \subseteq \text{NCint}(\text{NCcl}(\text{NCint}(\mathcal{F}))) \subseteq \mathcal{A} \Rightarrow \text{NCint}(\text{NCcl}(\text{NCint}(\text{NCcl}(\mathcal{A})))) \subseteq \mathcal{A}$ .

(iii)  $\Rightarrow$  (i) Let  $\text{NCint}(\text{NCcl}(\text{NCint}(\text{NCcl}(\mathcal{A})))) \subseteq \mathcal{A}$ . To prove  $\mathcal{A} \in \text{NCS}\alpha\text{C}(\mathcal{U})$ , i.e., to prove  $\mathcal{A}^c \in \text{NCS}\alpha\text{O}(\mathcal{U})$ . Then  $\mathcal{A}^c \subseteq (\text{NCint}(\text{NCcl}(\text{NCint}(\text{NCcl}(\mathcal{A}))))^c = \text{NCcl}(\text{NCint}(\text{NCcl}(\text{NCint}(\mathcal{A}^c))))$ , but  $(\text{NCint}(\text{NCcl}(\text{NCint}(\text{NCcl}(\mathcal{A}))))^c = \text{NCcl}(\text{NCint}(\text{NCcl}(\text{NCint}(\mathcal{A}^c))))$ .

Hence  $\mathcal{A}^c \subseteq \text{NCcl}(\text{NCint}(\text{NCcl}(\text{NCint}(\mathcal{A}^c))))$ , and therefore  $\mathcal{A}^c \in \text{NCS}\alpha\text{O}(\mathcal{U})$ , i.e.,  $\mathcal{A} \in \text{NCS}\alpha\text{C}(\mathcal{U})$ .

**Theorem 3.12:**

The union of any family of  $\text{NCS}\alpha\text{-OS}$  is a  $\text{NCS}\alpha\text{-OS}$ .

**Proof:** Let  $\{\mathcal{A}_\lambda\}_{\lambda \in \Lambda}$  be a family of  $\text{NCS}\alpha\text{-OS}$ . To prove  $\bigcup_{\lambda \in \Lambda} \mathcal{A}_\lambda$  is a  $\text{NCS}\alpha\text{-OS}$ . Since  $\mathcal{A}_\lambda \in \text{NCS}\alpha\text{O}(\mathcal{U})$ . Then there is a NC-OS  $\mathcal{B}_\lambda$  such that  $\mathcal{B}_\lambda \subseteq \mathcal{A}_\lambda \subseteq \text{NCcl}(\mathcal{B}_\lambda)$ ,  $\forall \lambda \in \Lambda$ . Hence  $\bigcup_{\lambda \in \Lambda} \mathcal{B}_\lambda \subseteq \bigcup_{\lambda \in \Lambda} \mathcal{A}_\lambda \subseteq \bigcup_{\lambda \in \Lambda} \text{NCcl}(\mathcal{B}_\lambda) \subseteq \text{NCcl}(\bigcup_{\lambda \in \Lambda} \mathcal{B}_\lambda)$ . But  $\bigcup_{\lambda \in \Lambda} \mathcal{B}_\lambda \in \text{NC}\alpha\text{O}(\mathcal{U})$  (by Proposition (2.7)). Hence  $\bigcup_{\lambda \in \Lambda} \mathcal{A}_\lambda \in \text{NCS}\alpha\text{O}(\mathcal{U})$ .

**Corollary 3.13:**

The intersection of any family of  $\text{NCS}\alpha\text{-CS}$  is a  $\text{NCS}\alpha\text{-CS}$ .

**Proof:** This follows directly from Theorem (3.12).

**Remark 3.14:**

The following diagram shows the relations among the different types of weakly neutrosophic crisp closed sets that were studied in this section:

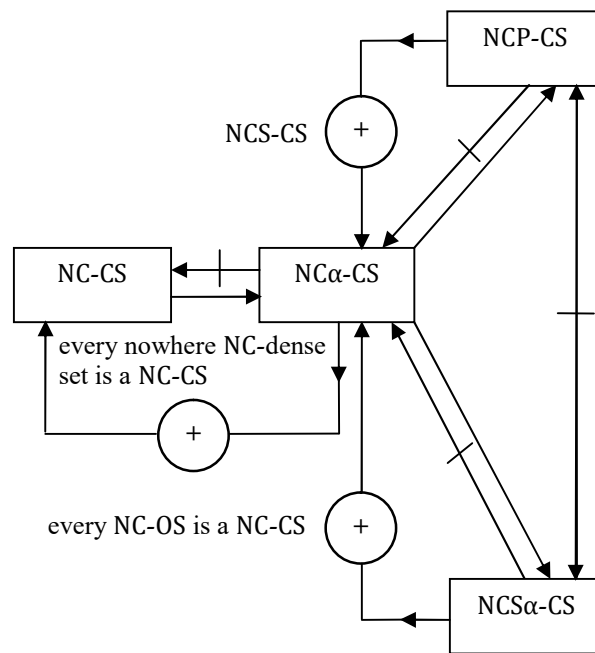

**Diagram (3.1)**



#### 4. Neutrosophic Crisp Semi- $\alpha$ -Closure and Neutrosophic Crisp Semi- $\alpha$ -Interior

We present neutrosophic crisp semi- $\alpha$ -closure and neutrosophic crisp semi- $\alpha$ -interior and obtain some of their properties in this section.

**Definition 4.1:**

The intersection of all NCS $\alpha$ -CS in a neutrosophic crisp topological space  $(\mathcal{U}, T)$  containing  $\mathcal{A}$  is called neutrosophic crisp semi- $\alpha$ -closure of  $\mathcal{A}$  and is denoted by  $S\alpha NCcl(\mathcal{A})$ ,  $S\alpha NCcl(\mathcal{A}) = \bigcap \{\mathcal{B} : \mathcal{A} \subseteq \mathcal{B}, \mathcal{B} \text{ is a NCS}\alpha\text{-CS}\}$ .

**Definition 4.2:**

The union of all NCS $\alpha$ -OS in a neutrosophic crisp topological space  $(\mathcal{U}, T)$  contained in  $\mathcal{A}$  is called neutrosophic crisp semi- $\alpha$ -interior of  $\mathcal{A}$  and is denoted by  $S\alpha NCint(\mathcal{A})$ ,  $S\alpha NCint(\mathcal{A}) = \bigcup \{\mathcal{B} : \mathcal{B} \subseteq \mathcal{A}, \mathcal{B} \text{ is a NCS}\alpha\text{-OS}\}$ .

**Proposition 4.3:**

Let  $\mathcal{A}$  be any neutrosophic crisp set in a neutrosophic crisp topological space  $(\mathcal{U}, T)$ , the following properties are true:

- (i)  $S\alpha NCcl(\mathcal{A}) = \mathcal{A}$  iff  $\mathcal{A}$  is a NCS $\alpha$ -CS.
- (ii)  $S\alpha NCint(\mathcal{A}) = \mathcal{A}$  iff  $\mathcal{A}$  is a NCS $\alpha$ -OS.
- (iii)  $S\alpha NCcl(\mathcal{A})$  is the smallest NCS $\alpha$ -CS containing  $\mathcal{A}$ .
- (iv)  $S\alpha NCint(\mathcal{A})$  is the largest NCS $\alpha$ -OS contained in  $\mathcal{A}$ .

**Proof:** (i), (ii), (iii) and (iv) are obvious.

**Proposition 4.4:**

Let  $\mathcal{A}$  be any neutrosophic crisp set in a neutrosophic crisp topological space  $(\mathcal{U}, T)$ , the following properties hold:

- (i)  $S\alpha NCint(\mathcal{U}_N - \mathcal{A}) = \mathcal{U}_N - (S\alpha NCcl(\mathcal{A}))$ ,
- (ii)  $S\alpha NCcl(\mathcal{U}_N - \mathcal{A}) = \mathcal{U}_N - (S\alpha NCint(\mathcal{A}))$ .

**Proof:** (i) By definition (2.3),  $S\alpha NCcl(\mathcal{A}) = \bigcap \{\mathcal{B} : \mathcal{A} \subseteq \mathcal{B}, \mathcal{B} \text{ is a NCS}\alpha\text{-CS}\}$   
 $\mathcal{U}_N - (S\alpha NCcl(\mathcal{A})) = \mathcal{U}_N - \bigcap \{\mathcal{B} : \mathcal{A} \subseteq \mathcal{B}, \mathcal{B} \text{ is a NCS}\alpha\text{-CS}\}$   
 $= \bigcup \{\mathcal{U}_N - \mathcal{B} : \mathcal{A} \subseteq \mathcal{B}, \mathcal{B} \text{ is a NCS}\alpha\text{-CS}\}$   
 $= \bigcup \{\mathcal{H} : \mathcal{H} \subseteq \mathcal{U}_N - \mathcal{A}, \mathcal{H} \text{ is a NCS}\alpha\text{-OS}\}$   
 $= S\alpha NCint(\mathcal{U}_N - \mathcal{A})$ .

- (ii) The proof is similar to (i).

**Theorem 4.5:**

Let  $\mathcal{A}$  and  $\mathcal{B}$  be two neutrosophic crisp sets in a neutrosophic crisp topological space  $(\mathcal{U}, T)$ . The following properties hold:

- (i)  $S\alpha NCcl(\emptyset_N) = \emptyset_N$ ,  $S\alpha NCcl(\mathcal{U}_N) = \mathcal{U}_N$ .
- (ii)  $\mathcal{A} \subseteq S\alpha NCcl(\mathcal{A})$ .
- (iii)  $\mathcal{A} \subseteq \mathcal{B} \Rightarrow S\alpha NCcl(\mathcal{A}) \subseteq S\alpha NCcl(\mathcal{B})$ .
- (iv)  $S\alpha NCcl(\mathcal{A} \cap \mathcal{B}) \subseteq S\alpha NCcl(\mathcal{A}) \cap S\alpha NCcl(\mathcal{B})$ .
- (v)  $S\alpha NCcl(\mathcal{A}) \cup S\alpha NCcl(\mathcal{B}) \subseteq S\alpha NCcl(\mathcal{A} \cup \mathcal{B})$ .
- (vi)  $S\alpha NCcl(S\alpha NCcl(\mathcal{A})) = S\alpha NCcl(\mathcal{A})$ .

**Proof:** (i) and (ii) are evident.

(iii) By (ii),  $\mathcal{B} \subseteq S\alpha NCcl(\mathcal{B})$ . Since  $\mathcal{A} \subseteq \mathcal{B}$ , we have  $\mathcal{A} \subseteq S\alpha NCcl(\mathcal{B})$ . But  $S\alpha NCcl(\mathcal{B})$  is a NCS $\alpha$ -CS. Thus  $S\alpha NCcl(\mathcal{B})$  is a NCS $\alpha$ -CS containing  $\mathcal{A}$ .

Since  $S\alpha NCcl(\mathcal{A})$  is the smallest NCS $\alpha$ -CS containing  $\mathcal{A}$ , we have  $S\alpha NCcl(\mathcal{A}) \subseteq S\alpha NCcl(\mathcal{B})$ . Hence,  $\mathcal{A} \subseteq \mathcal{B} \Rightarrow S\alpha NCcl(\mathcal{A}) \subseteq S\alpha NCcl(\mathcal{B})$ .

(iv) We know that  $\mathcal{A} \cap \mathcal{B} \subseteq \mathcal{A}$  and  $\mathcal{A} \cap \mathcal{B} \subseteq \mathcal{B}$ . Therefore, by (iii),  $S\alpha NCcl(\mathcal{A} \cap \mathcal{B}) \subseteq S\alpha NCcl(\mathcal{A})$  and  $S\alpha NCcl(\mathcal{A} \cap \mathcal{B}) \subseteq S\alpha NCcl(\mathcal{B})$ . Hence  $S\alpha NCcl(\mathcal{A} \cap \mathcal{B}) \subseteq S\alpha NCcl(\mathcal{A}) \cap S\alpha NCcl(\mathcal{B})$ .

(v) Since  $\mathcal{A} \subseteq \mathcal{A} \cup \mathcal{B}$  and  $\mathcal{B} \subseteq \mathcal{A} \cup \mathcal{B}$ , it follows from part (iii) that  $S\alpha NCcl(\mathcal{A}) \subseteq S\alpha NCcl(\mathcal{A} \cup \mathcal{B})$  and  $S\alpha NCcl(\mathcal{B}) \subseteq S\alpha NCcl(\mathcal{A} \cup \mathcal{B})$ . Hence  $S\alpha NCcl(\mathcal{A}) \cup S\alpha NCcl(\mathcal{B}) \subseteq S\alpha NCcl(\mathcal{A} \cup \mathcal{B})$ .

(vi) Since  $S\alpha NCcl(\mathcal{A})$  is a NCS $\alpha$ -CS, we have by Proposition (4.3)(i),  $S\alpha NCcl(S\alpha NCcl(\mathcal{A})) = S\alpha NCcl(\mathcal{A})$ .

**Theorem 4.6:**

Let  $\mathcal{A}$  and  $\mathcal{B}$  be two neutrosophic crisp sets in a neutrosophic crisp topological space  $(\mathcal{U}, T)$ . The following properties hold:

- (i)  $S\alpha NCint(\emptyset_N) = \emptyset_N$ ,  $S\alpha NCint(\mathcal{U}_N) = \mathcal{U}_N$ .
- (ii)  $S\alpha NCint(\mathcal{A}) \subseteq \mathcal{A}$ .

- (iii)  $\mathcal{A} \subseteq \mathcal{B} \Rightarrow SaNCint(\mathcal{A}) \subseteq SaNCint(\mathcal{B})$ .
- (iv)  $SaNCint(\mathcal{A} \cap \mathcal{B}) \subseteq SaNCint(\mathcal{A}) \cap SaNCint(\mathcal{B})$ .
- (v)  $SaNCint(\mathcal{A}) \cup SaNCint(\mathcal{B}) \subseteq SaNCint(\mathcal{A} \cup \mathcal{B})$ .
- (vi)  $SaNCint(SaNCint(\mathcal{A})) = SaNCint(\mathcal{A})$ .

**Proof:** (i), (ii), (iii), (iv), (v) and (vi) are obvious.

**Proposition 4.7:**

For any neutrosophic crisp subset  $\mathcal{A}$  of a neutrosophic crisp topological space  $(\mathcal{U}, T)$ , then:

- (i)  $NCint(\mathcal{A}) \subseteq \alpha NCint(\mathcal{A}) \subseteq SaNCint(\mathcal{A}) \subseteq SaNCcl(\mathcal{A}) \subseteq \alpha NCcl(\mathcal{A}) \subseteq NCcl(\mathcal{A})$ .
- (ii)  $NCint(SaNCint(\mathcal{A})) = SaNCint(NCint(\mathcal{A})) = NCint(\mathcal{A})$ .
- (iii)  $\alpha NCint(SaNCint(\mathcal{A})) = SaNCint(\alpha NCint(\mathcal{A})) = \alpha NCint(\mathcal{A})$ .
- (iv)  $NCcl(SaNCcl(\mathcal{A})) = SaNCcl(NCcl(\mathcal{A})) = NCcl(\mathcal{A})$ .
- (v)  $\alpha NCcl(SaNCcl(\mathcal{A})) = SaNCcl(\alpha NCcl(\mathcal{A})) = \alpha NCcl(\mathcal{A})$ .
- (vi)  $SaNCcl(\mathcal{A}) = \mathcal{A} \cup NCint(NCcl(NCint(NCcl(\mathcal{A}))))$ .
- (vii)  $SaNCint(\mathcal{A}) = \mathcal{A} \cap NCcl(NCint(NCcl(NCint(\mathcal{A}))))$ .
- (viii)  $NCint(NCcl(\mathcal{A})) \subseteq SaNCint(SaNCcl(\mathcal{A}))$ .

**Proof:** We shall prove only (ii), (iii), (iv), (vii) and (viii).

(ii) To prove  $NCint(SaNCint(\mathcal{A})) = SaNCint(NCint(\mathcal{A})) = NCint(\mathcal{A})$ , we know that  $NCint(\mathcal{A})$  is a NC-OS. It follows that  $NCint(\mathcal{A})$  is a NCS $\alpha$ -OS. Hence  $NCint(\mathcal{A}) = SaNCint(NCint(\mathcal{A}))$  (by Proposition (4.3)).

Therefore:  $NCint(\mathcal{A}) = SaNCint(NCint(\mathcal{A}))$ .....(1)

Since  $NCint(\mathcal{A}) \subseteq SaNCint(\mathcal{A}) \Rightarrow NCint(NCint(\mathcal{A})) \subseteq NCint(SaNCint(\mathcal{A})) \Rightarrow NCint(\mathcal{A}) \subseteq NCint(SaNCint(\mathcal{A}))$ . Also,  $SaNCint(\mathcal{A}) \subseteq \mathcal{A} \Rightarrow NCint(SaNCint(\mathcal{A})) \subseteq NCint(\mathcal{A})$ .

Hence:  $NCint(\mathcal{A}) = NCint(SaNCint(\mathcal{A}))$ .....(2)

Therefore by (1) and (2), we get  $NCint(SaNCint(\mathcal{A})) = SaNCint(NCint(\mathcal{A})) = NCint(\mathcal{A})$ .

(iii) Now we prove  $\alpha NCint(SaNCint(\mathcal{A})) = SaNCint(\alpha NCint(\mathcal{A})) = \alpha NCint(\mathcal{A})$ .

Since  $\alpha NCint(\mathcal{A})$  is NC $\alpha$ -OS, therefore  $\alpha NCint(\mathcal{A})$  is NCS $\alpha$ -OS. Therefore by Proposition (4.3):

$\alpha NCint(\mathcal{A}) = SaNCint(\alpha NCint(\mathcal{A}))$ .....(1)

Now, to prove  $\alpha NCint(\mathcal{A}) = \alpha NCint(SaNCint(\mathcal{A}))$ , we have  $\alpha NCint(\mathcal{A}) \subseteq SaNCint(\mathcal{A}) \Rightarrow \alpha NCint(\alpha NCint(\mathcal{A})) \subseteq \alpha NCint(SaNCint(\mathcal{A})) \Rightarrow \alpha NCint(\mathcal{A}) \subseteq \alpha NCint(SaNCint(\mathcal{A}))$ .

Also,  $SaNCint(\mathcal{A}) \subseteq \mathcal{A} \Rightarrow \alpha NCint(SaNCint(\mathcal{A})) \subseteq \alpha NCint(\mathcal{A})$ .

Hence:  $\alpha NCint(\mathcal{A}) = \alpha NCint(SaNCint(\mathcal{A}))$ .....(2)

Therefore by (1) and (2), we get  $\alpha NCint(SaNCint(\mathcal{A})) = SaNCint(\alpha NCint(\mathcal{A})) = \alpha NCint(\mathcal{A})$ .

(iv) To prove  $NCcl(SaNCcl(\mathcal{A})) = SaNCcl(NCcl(\mathcal{A})) = NCcl(\mathcal{A})$ . We know that  $NCcl(\mathcal{A})$  is a NC-CS, so it is NCS $\alpha$ -CS. Hence by proposition (4.3), we have:  $NCcl(\mathcal{A}) = SaNCcl(NCcl(\mathcal{A}))$ .....(1)

To prove  $NCcl(\mathcal{A}) = NCcl(SaNCcl(\mathcal{A}))$ , we have  $SaNCcl(\mathcal{A}) \subseteq NCcl(\mathcal{A})$  (by part (i)).

Then  $NCcl(SaNCcl(\mathcal{A})) \subseteq NCcl(NCcl(\mathcal{A})) = NCcl(\mathcal{A}) \Rightarrow NCcl(SaNCcl(\mathcal{A})) \subseteq NCcl(\mathcal{A})$ .

Since  $\mathcal{A} \subseteq SaNCcl(\mathcal{A}) \subseteq NCcl(SaNCcl(\mathcal{A}))$ , then  $\mathcal{A} \subseteq NCcl(SaNCcl(\mathcal{A}))$ .

Hence,  $NCcl(\mathcal{A}) \subseteq NCcl(NCcl(SaNCcl(\mathcal{A}))) = NCcl(SaNCcl(\mathcal{A})) \Rightarrow NCcl(\mathcal{A}) \subseteq NCcl(SaNCcl(\mathcal{A}))$

and therefore:  $NCcl(\mathcal{A}) = NCcl(SaNCcl(\mathcal{A}))$ .....(2)

Now, by (1) and (2), we get that  $NCcl(SaNCcl(\mathcal{A})) = SaNCcl(NCcl(\mathcal{A}))$ . Hence  $NCcl(SaNCcl(\mathcal{A})) = SaNCcl(NCcl(\mathcal{A})) = NCcl(\mathcal{A})$ .

(vii) To prove  $SaNCint(\mathcal{A}) = \mathcal{A} \cap NCcl(NCint(NCcl(NCint(\mathcal{A}))))$ , since  $SaNCint(\mathcal{A}) \in NCS\alpha O(\mathcal{U}) \Rightarrow SaNCint(\mathcal{A}) \subseteq NCcl(NCint(NCcl(NCint(SaNCint(\mathcal{A})))) = NCcl(NCint(NCcl(NCint(\mathcal{A}))))$

(by part (ii)). Hence,  $SaNCint(\mathcal{A}) \subseteq NCcl(NCint(NCcl(NCint(\mathcal{A}))))$ , also  $SaNCint(\mathcal{A}) \subseteq \mathcal{A}$ . Then:

$SaNCint(\mathcal{A}) \subseteq \mathcal{A} \cap NCcl(NCint(NCcl(NCint(\mathcal{A}))))$ .....(1)

To prove  $\mathcal{A} \cap NCcl(NCint(NCcl(NCint(\mathcal{A}))))$  is a NCS $\alpha$ -OS contained in  $\mathcal{A}$ .

It is clear that  $\mathcal{A} \cap NCcl(NCint(NCcl(NCint(\mathcal{A})))) \subseteq NCcl(NCint(NCcl(NCint(\mathcal{A}))))$  and also it is clear that  $NCint(\mathcal{A}) \subseteq NCcl(NCint(\mathcal{A})) \Rightarrow NCint(NCint(\mathcal{A})) \subseteq NCint(NCcl(NCint(\mathcal{A}))) \Rightarrow NCint(\mathcal{A}) \subseteq NCint(NCcl(NCint(\mathcal{A}))) \Rightarrow NCcl(NCint(\mathcal{A})) \subseteq NCcl(NCint(NCcl(NCint(\mathcal{A})))$  and  $NCint(\mathcal{A}) \subseteq NCcl(NCint(\mathcal{A})) \Rightarrow NCint(\mathcal{A}) \subseteq NCcl(NCint(NCcl(NCint(\mathcal{A}))))$  and  $NCint(\mathcal{A}) \subseteq \mathcal{A} \Rightarrow NCint(\mathcal{A}) \subseteq \mathcal{A} \cap NCcl(NCint(NCcl(NCint(\mathcal{A}))))$ . We get  $NCint(\mathcal{A}) \subseteq \mathcal{A} \cap NCcl(NCint(NCcl(NCint(\mathcal{A})))) \subseteq NCcl(NCint(NCcl(NCint(\mathcal{A}))))$ . Hence  $\mathcal{A} \cap NCcl(NCint(NCcl(NCint(\mathcal{A}))))$  is a NCS $\alpha$ -OS (by Proposition (4.3)). Also,  $\mathcal{A} \cap NCcl(NCint(NCcl(NCint(\mathcal{A}))))$  is contained in  $\mathcal{A}$ .

Then  $\mathcal{A} \cap NCcl(NCint(NCcl(NCint(\mathcal{A})))) \subseteq SaNCint(\mathcal{A})$  (since  $SaNCint(\mathcal{A})$  is the largest NCS $\alpha$  - OS contained in  $\mathcal{A}$ ). Hence:  $\mathcal{A} \cap NCcl(NCint(NCcl(NCint(\mathcal{A})))) \subseteq SaNCint(\mathcal{A})$ .....(2)

By (1) and (2), we get that  $SaNCint(\mathcal{A}) = \mathcal{A} \cap NCcl(NCint(NCcl(NCint(\mathcal{A}))))$ .

(viii) To prove that  $NCint(NCcl(\mathcal{A})) \subseteq SaNCint(SaNCcl(\mathcal{A}))$ , we know that  $SaNCcl(\mathcal{A})$  is a NCS $\alpha$ -CS, therefore  $NCint(NCcl(NCint(NCcl(SaNCcl(\mathcal{A})))) \subseteq SaNCcl(\mathcal{A})$  (by Corollary (3.11)). Hence  $NCint(NCcl(\mathcal{A})) \subseteq NCint(NCcl(NCint(NCcl(\mathcal{A})))) \subseteq SaNCcl(\mathcal{A})$  (by part (iv)). Therefore,

$S\alpha NCint(NCint(NCcl(\mathcal{A}))) \subseteq S\alpha NCint(S\alpha NCcl(\mathcal{A})) \Rightarrow NCint(NCcl(\mathcal{A})) \subseteq S\alpha NCint(S\alpha NCcl(\mathcal{A}))$  (by (ii)).

**Theorem 4.8:**

For any neutrosophic crisp subset  $\mathcal{A}$  of a neutrosophic crisp topological space  $(\mathcal{U}, T)$ . The following properties are equivalent:

- (i)  $\mathcal{A} \in NCS\alpha O(\mathcal{U})$ .
- (ii)  $\mathcal{H} \subseteq \mathcal{A} \subseteq NCcl(NCint(NCcl(\mathcal{H})))$ , for some NC-OS  $\mathcal{H}$ .
- (iii)  $\mathcal{H} \subseteq \mathcal{A} \subseteq SNCint(NCcl(\mathcal{H}))$ , for some NC-OS  $\mathcal{H}$ .
- (iv)  $\mathcal{A} \subseteq SNCint(NCcl(NCint(\mathcal{A})))$ .

**Proof:**

(i)  $\Rightarrow$  (ii) Let  $\mathcal{A} \in NCS\alpha O(\mathcal{U})$ , then  $\mathcal{A} \subseteq NCcl(NCint(NCcl(NCint(\mathcal{A}))))$  and  $NCint(\mathcal{A}) \subseteq \mathcal{A}$ . Hence  $\mathcal{H} \subseteq \mathcal{A} \subseteq NCcl(NCint(NCcl(\mathcal{H})))$ , where  $\mathcal{H} = NCint(\mathcal{A})$ .

(ii)  $\Rightarrow$  (iii) Suppose  $\mathcal{H} \subseteq \mathcal{A} \subseteq NCcl(NCint(NCcl(\mathcal{H})))$ , for some NC-OS  $\mathcal{H}$ . But  $SNCint(NCcl(\mathcal{H})) = NCcl(NCint(NCcl(\mathcal{H})))$  (by Proposition (2.8)). Then  $\mathcal{H} \subseteq \mathcal{A} \subseteq SNCint(NCcl(\mathcal{H}))$ , for some NC-OS  $\mathcal{H}$ .

(iii)  $\Rightarrow$  (iv) Suppose that  $\mathcal{H} \subseteq \mathcal{A} \subseteq SNCint(NCcl(\mathcal{H}))$ , for some NC-OS  $\mathcal{H}$ . Since  $\mathcal{H}$  is a NC-OS contained in  $\mathcal{A}$ . Then  $\mathcal{H} \subseteq NCint(\mathcal{A}) \Rightarrow NCcl(\mathcal{H}) \subseteq NCcl(NCint(\mathcal{A}))$

$\Rightarrow SNCint(NCcl(\mathcal{H})) \subseteq SNCint(NCcl(NCint(\mathcal{A})))$ . But  $\mathcal{A} \subseteq SNCint(NCcl(\mathcal{H}))$  (by hypothesis), then  $\mathcal{A} \subseteq SNCint(NCcl(NCint(\mathcal{A})))$ .

(iv)  $\Rightarrow$  (i) Let  $\mathcal{A} \subseteq SNCint(NCcl(NCint(\mathcal{A})))$ .

But  $SNCint(NCcl(NCint(\mathcal{A}))) = NCcl(NCint(NCcl(NCint(\mathcal{A}))))$  (by Proposition (2.8)).

Hence,  $\mathcal{A} \subseteq NCcl(NCint(NCcl(NCint(\mathcal{A})))) \Rightarrow \mathcal{A} \in NCS\alpha O(\mathcal{U})$ .

**Corollary 4.9:**

For any neutrosophic crisp subset  $\mathcal{B}$  of a neutrosophic crisp topological space  $(\mathcal{U}, T)$ , the following properties are equivalent:

- (i)  $\mathcal{B} \in NCS\alpha C(\mathcal{U})$ .
- (ii)  $NCint(NCcl(NCint(\mathcal{F}))) \subseteq \mathcal{B} \subseteq \mathcal{F}$ , for some  $\mathcal{F}$  NC-CS.
- (iii)  $SNCcl(NCint(\mathcal{F})) \subseteq \mathcal{B} \subseteq \mathcal{F}$ , for some  $\mathcal{F}$  NC-CS.
- (iv)  $SNCcl(NCint(NCcl(\mathcal{B}))) \subseteq \mathcal{B}$ .

**Proof:**

(i)  $\Rightarrow$  (ii) Let  $\mathcal{B} \in NCS\alpha C(\mathcal{U}) \Rightarrow NCint(NCcl(NCint(NCcl(\mathcal{B})))) \subseteq \mathcal{B}$  (by Corollary(3.11)) and  $\mathcal{B} \subseteq NCcl(\mathcal{B})$ . Hence we obtain  $NCint(NCcl(NCint(NCcl(\mathcal{B})))) \subseteq \mathcal{B} \subseteq NCcl(\mathcal{B})$ .

Therefore,  $NCint(NCcl(NCint(\mathcal{F}))) \subseteq \mathcal{B} \subseteq \mathcal{F}$ , where  $\mathcal{F} = NCcl(\mathcal{B})$ .

(ii)  $\Rightarrow$  (iii) Let  $NCint(NCcl(NCint(\mathcal{F}))) \subseteq \mathcal{B} \subseteq \mathcal{F}$ , for some  $\mathcal{F}$  NC-CS. But  $NCint(NCcl(NCint(\mathcal{F}))) = SNCcl(NCint(\mathcal{F}))$  (by Proposition (2.8)). Hence  $SNCcl(NCint(\mathcal{F})) \subseteq \mathcal{B} \subseteq \mathcal{F}$ , for some  $\mathcal{F}$  NC-CS.

(iii)  $\Rightarrow$  (iv) Let  $SNCcl(NCint(\mathcal{F})) \subseteq \mathcal{B} \subseteq \mathcal{F}$ , for some  $\mathcal{F}$  NC-CS. Since  $\mathcal{B} \subseteq \mathcal{F}$  (by hypothesis), then we have  $NCcl(\mathcal{B}) \subseteq \mathcal{F} \Rightarrow NCint(NCcl(\mathcal{B})) \subseteq NCint(\mathcal{F}) \Rightarrow SNCcl(NCint(NCcl(\mathcal{B}))) \subseteq SNCcl(NCint(\mathcal{F})) \subseteq \mathcal{B} \Rightarrow SNCcl(NCint(NCcl(\mathcal{B}))) \subseteq \mathcal{B}$ .

(iv)  $\Rightarrow$  (i) Let  $SNCcl(NCint(NCcl(\mathcal{B}))) \subseteq \mathcal{B}$ .

But  $SNCcl(NCint(NCcl(\mathcal{B}))) = NCint(NCcl(NCint(NCcl(\mathcal{B}))))$  (by Proposition (2.8)).

Hence,  $NCint(NCcl(NCint(NCcl(\mathcal{B})))) \subseteq \mathcal{B} \Rightarrow \mathcal{B} \in NCS\alpha C(\mathcal{U})$ .

**5. Conclusion**

In this work, we have the new concept of neutrosophic crisp closed sets called neutrosophic crisp semi- $\alpha$ -closed sets and studied their fundamental properties in neutrosophic crisp topological spaces. The neutrosophic crisp semi- $\alpha$ -closed sets can obtain to derive a new decomposition of neutrosophic crisp continuity.

**References**

- [1] A. A. Salama and S. A. Alblowi, Neutrosophic set and neutrosophic topological spaces. IOSR Journal of Mathematics, 3(2012), 31-35.
- [2] A. A. Salama, F. Smarandache and V. Kroumov, Neutrosophic crisp sets and neutrosophic crisp topological spaces. Neutrosophic Sets and Systems, 2(2014), 25-30.
- [3] A. A. Salama, Basic structure of some classes of neutrosophic crisp nearly open sets & possible application to GIS topology. Neutrosophic Sets and Systems, 7(2015), 18-22.
- [4] F. Smarandache, A unifying field in logics: neutrosophic logic, neutrosophy, neutrosophic set, neutrosophic probability. American Research Press, Rehoboth, NM, (1999).

- [5] F. Smarandache, Neutrosophy and neutrosophic logic, first international conference on neutrosophy, neutrosophic logic, set, probability, and statistics, University of New Mexico, Gallup, NM 87301, USA (2002).
- [6] Q. H. Imran, F. Smarandache, R. K. Al-Hamido and R. Dhavaseelan, On neutrosophic semi- $\alpha$ -open sets. *Neutrosophic Sets and Systems*, 18(2017), 37-42.
- [7] W. Al-Omeri, Neutrosophic crisp sets via neutrosophic crisp topological spaces NCTS. *Neutrosophic Sets and Systems*, 13(2016), 96-104.
- [8] Arindam Dey, Said Broumi, Le Hoang Son, Assia Bakali, Mohamed Talea, Florentin Smarandache, "A new algorithm for finding minimum spanning trees with undirected neutrosophic graphs", *Granular Computing (Springer)*, pp.1-7, 2018.
- [9] S Broumi, A Dey, A Bakali, M Talea, F Smarandache, LH Son, D Koley, "Uniform Single Valued Neutrosophic Graphs", *Neutrosophic sets and systems*, 2017.
- [10] S Broumi, A Bakali, M Talea, F Smarandache, A. Dey, LH Son, "Spanning tree problem with Neutrosophic edge weights", in *Proceedings of the 3rd International Conference on intelligence computing in data science*, Elsevier, science direct, *Procedia computer science*, 2018.
- [11] Said Broumi; Arindam Dey; Assia Bakali; Mohamed Talea; Florentin Smarandache; Dipak Koley, "An algorithmic approach for computing the complement of intuitionistic fuzzy graphs" 2017 13th International Conference on Natural Computation, Fuzzy Systems and Knowledge Discovery (ICNC-FSKD)
- [12] Abdel-Basset, M., Mohamed, M., Smarandache, F., & Chang, V. (2018). Neutrosophic Association Rule Mining Algorithm for Big Data Analysis. *Symmetry*, 10(4), 106.
- [13] Abdel-Basset, M., & Mohamed, M. (2018). The Role of Single Valued Neutrosophic Sets and Rough Sets in Smart City: Imperfect and Incomplete Information Systems. *Measurement*. [Volume 124](#), August 2018, Pages 47-55 [14] Abdel-Basset, M., Gunasekaran, M., Mohamed, M., & Smarandache, F. A novel method for solving the fully neutrosophic linear programming problems. *Neural Computing and Applications*, 1-11.
- [15] Abdel-Basset, M., Manogaran, G., Gamal, A., & Smarandache, F. (2018). A hybrid approach of neutrosophic sets and DEMATEL method for developing supplier selection criteria. *Design Automation for Embedded Systems*, 1- 22.
- [16] Abdel-Basset, M., Mohamed, M., & Chang, V. (2018). NMCDA: A framework for evaluating cloud computing services. *Future Generation Computer Systems*, 86, 12-29.
- [17] Abdel-Basset, M., Mohamed, M., Zhou, Y., & Hezam, I. (2017). Multi-criteria group decision making based on neutrosophic analytic hierarchy process. *Journal of Intelligent & Fuzzy Systems*, 33(6), 4055-4066.
- [18] Abdel-Basset, M.; Mohamed, M.; Smarandache, F. An Extension of Neutrosophic AHP–SWOT Analysis for Strategic Planning and Decision-Making. *Symmetry* 2018, 10, 116.
- [19] Abdel-Basset, Mohamed, et al. "A novel group decision-making model based on triangular neutrosophic numbers." *Soft Computing* (2017): 1-15. DOI: <https://doi.org/10.1007/s00500-017-2758-5>
- [20] Abdel-Baset, Mohamed, Ibrahim M. Hezam, and Florentin Smarandache. "Neutrosophic goal programming." *Neutrosophic Sets Syst* 11 (2016): 112-118.
- [21] El-Hefenawy, Nancy, et al. "A review on the applications of neutrosophic sets." *Journal of Computational and Theoretical Nanoscience* 13.1 (2016): 936-944.

Received: June 18, 2018. Accepted: July 9, 2018.



# Rough Neutrosophic Multisets Relation with Application in Marketing Strategy

Suriana Alias<sup>1</sup>, Daud Mohamad<sup>2</sup>, and Adibah Shuib<sup>3</sup>

<sup>1</sup>Faculty of Computer and Mathematical Sciences, Universiti Teknologi Mara (UiTM) Kelantan, Campus Machang, Kelantan, 18500, Malaysia. E-mail: suria588@kelantan.uitm.edu.my

<sup>2</sup>Faculty of Computer and Mathematical Sciences, Universiti Teknologi Mara (UiTM) Shah Alam, Shah Alam, 40450, Malaysia. E-mail: daud@tmsk.uitm.edu.my

<sup>3</sup>Faculty of Computer and Mathematical Sciences, Universiti Teknologi Mara (UiTM) Shah Alam, Shah Alam, 40450, Malaysia. E-mail: adibah@tmsk.uitm.edu.my

**Abstract.** The concepts of rough neutrosophic multisets can be easily extended to a relation, mainly since a relation is also a set, i.e. a subset of a Cartesian product. Therefore, the objective of this paper is to define the definition of rough neutrosophic multisets relation of Cartesian product over a universal set. Some of the relation properties of rough neutrosophic multisets such as max, min, the composition of two rough neutrosophic multisets relation, inverse rough neutrosophic multisets relation, and reflexive, symmetric and transitive rough neutrosophic multisets relation over the universe are defined. Subsequently, their properties are successfully proven. Finally, the application of rough neutrosophic multisets relation for decision making in marketing strategy is presented.

**Keywords:** Neutrosophic Multisets, relation, rough set, rough neutrosophic multisets

## 1 Introduction

Imperfect information resulted in an incomplete, imprecision, inconsistency and uncertainty information whereby all the condition must be overcome to represent the perfect information. A relation between each information from the same universe or object is also an important criterion of the information to explain the strong relationship element between them. Fuzzy sets as defined by Zadeh [1] has been used to model the imperfect information especially for uncertainty types of information by representing the membership value between  $[0, 1]$ . This indicates the human thinking opinion by replacing the information of linguistic value. Many theories were later introduced with the aim of establishing a fuzzy relation structure [2]. Atanassov introduced an intuitionistic fuzzy set by generalizing the theory of fuzzy sets and introducing two grades of the membership function, namely the degree of membership function and degree of non-membership function [3]. This theory has made the uncertainty decision more interesting. Meanwhile, Burillo et al. studied the intuitionistic fuzzy relation with properties [4]. There are also another theory introduced for solving uncertainty condition such as rough set [5] and soft set [6]. All these studies have extended to rough relation [7] and soft set relation [8].

Smarandache introduced a neutrosophic set as a generalization of the intuitionistic fuzzy set theory [9]. He believed that somehow in a life situation, especially for uncertainty condition, there also exist in-between (indeterminacy) opinion or unexpected condition that cannot be controlled. Instead of two grades of the membership function, neutrosophic set introduced in-between (indeterminacy) function where there exists an element which consists of a set of truth membership function (T), indeterminacy function (I) and falsity membership function (F). Compared to other uncertainty theories, the neutrosophic set can deal with indeterminacy situation. The study in neutrosophic relation with properties are also discussed [10], [11].

Later, Smarandache et al. refined T, I, F to  $T_1, T_2, \dots, T_m$  and  $I_1, I_2, \dots, I_n$  and  $F_1, F_2, \dots, F_r$  was also known as a neutrosophic refined set or neutrosophic multisets [12], [13]. Instead of one-time occurring for each element of T, I, F, the neutrosophic refined set allowed an element of T, I, F to occur more than once with

possibly the same or different truth membership values, indeterminacy values, and falsity membership values. The study of the neutrosophic refined set is a generalization of a multi fuzzy set [14] and intuitionistic fuzzy multisets [15]. Later, Deli et al. have studied the relation on neutrosophic refined set with properties [16], [17]. Latest, Smarandache has discussed in detail about neutrosophic perspectives in theory and application parts for neutrosophic triplets, neutrosophic duplets, neutrosophic multisets, hybrid operators and modal logic [18]. The successful application of the neutrosophic refined set in multi criteria decision making problem such as in medical diagnosis and selection problem [13], [19]–[25] has made this theory more applicable in decision making area.

Hybrid theories of uncertainty and imprecision condition were introduced, especially with rough set theory, such as rough fuzzy set and fuzzy rough set [26], rough intuitionistic fuzzy set [27], intuitionistic rough fuzzy set [28], rough neutrosophic set [29], neutrosophic rough set [30], interval rough neutrosophic set [31], rough neutrosophic soft set [32], rough bipolar neutrosophic set [33], single valued neutrosophic rough set model [34] and rough neutrosophic multiset [35]. This is because a rough set theory can handle the imprecision condition from the existence of a value which cannot be measured with suitable precision. Samanta et al. have discussed the fuzzy rough relation on universe set and their properties [36]. Then, Xuan Thao et. al have extended that concept by introducing the rough fuzzy relations on the Cartesian product of two universal sets [37].

The hybrid theory of a rough set also gives a contribution for solving a problem in decision making area. Some researchers already proved that hybrid theory such as rough neutrosophic set can handle the decision making problem in order to get the best solution according to three membership degree (truth, indeterminate and falsity) [38]–[44].

The objective of this paper is to define a rough neutrosophic multisets relation properties as a novel notion. This study also generalizes relation properties of a rough fuzzy relation, rough intuitionistic fuzzy relation and rough neutrosophic relation over universal. Subsequently, their properties are examined.

The remaining parts of this paper are organized as follows. In section 2, some mathematical preliminary concepts were recalled for a deeper understanding of rough neutrosophic multisets relations. Section 3 introduces the definition of rough neutrosophic multisets relation of Cartesian product on a universe set with some examples. Related properties and operations are also investigated. Section 3 also defined the composition of two rough neutrosophic multisets relation, inverse rough neutrosophic multisets relation and the reflexive, symmetric and transitive rough neutrosophic multisets relation. Subsequently, their properties are examined. In section 4, the rough neutrosophic multisets relation is represented as a marketing strategy by evaluating the quality of the product. Finally, section 5 concludes the paper.

## 2 Preliminaries

In this section, some mathematical preliminary concepts were recalled to understanding more about rough neutrosophic multisets relations.

**Definition 2.1** ([10]) Let  $U$  be a non-empty set of objects,  $\mathcal{R}$  is an equivalence relation on  $U$ . Then the space  $(U, \mathcal{R})$  is called an approximation space. Let  $X$  be a fuzzy set on  $U$ . We define the lower and upper approximation set and upper approximation of  $X$ , respectively

$$\begin{aligned}\mathcal{R}_U(X) &= \{x \in U: [x]_{\mathcal{R}} \subset X\}, \\ \overline{\mathcal{R}}_U(X) &= \{x \in U: [x]_{\mathcal{R}} \cap X \neq \emptyset\}\end{aligned}$$

where

$$\begin{aligned}T_{\mathcal{R}_U}(X) &= \inf_{y \in U} \{T_X(y): y \in [x]_{\mathcal{R}}\}, \\ T_{\overline{\mathcal{R}}_U}(X) &= \sup_{y \in U} \{T_X(y): y \in [x]_{\mathcal{R}}\}.\end{aligned}$$

The boundary of  $X$ ,  $BND(X) = \overline{\mathcal{R}}_U(X) - \mathcal{R}_U(X)$ . The fuzzy set  $X$  is called the rough fuzzy set if  $BND(X) \neq \emptyset$ .

**Definition 2.2** ([18]) Let  $U$  be a non-empty set of objects,  $\mathcal{R}$  is an equivalence relation on  $U$ . Then the space  $(U, \mathcal{R})$  is called an approximation space. Let  $X$  be an intuitionistic fuzzy set on  $U$ . We define the lower and upper approximation set and upper approximation of  $X$ , respectively

$$\begin{aligned}\mathcal{R}_U(X) &= \{x \in U: [x]_{\mathcal{R}} \subset X\} \\ \overline{\mathcal{R}}_U(X) &= \{x \in U: [x]_{\mathcal{R}} \cap X \neq \emptyset\},\end{aligned}$$

where

$$T_{\underline{\mathcal{R}}_U}(X) = \inf_{y \in U} \{T_X(y) : y \in [x]_{\mathcal{R}}\},$$

$$T_{\overline{\mathcal{R}}_U}(X) = \sup_{y \in U} \{T_X(y) : y \in [x]_{\mathcal{R}}\},$$

$$F_{\underline{\mathcal{R}}_U}(X) = \sup_{y \in U} \{F_X(y) : y \in [x]_{\mathcal{R}}\},$$

$$F_{\overline{\mathcal{R}}_U}(X) = \inf_{y \in U} \{F_X(y) : y \in [x]_{\mathcal{R}}\}.$$

The boundary of  $X$ ,  $BND(X) = \overline{\mathcal{R}}_U(X) - \underline{\mathcal{R}}_U(X)$ . The intuitionistic fuzzy set  $X$  is called the rough intuitionistic fuzzy set if  $BND(X) \neq 0$ .

**Definition 2.3** ([6]) Let  $U$  be a non-null set and  $R$  be an equivalence relation on  $U$ . Let  $A$  be neutrosophic set in  $U$  with the membership function  $T_A$ , indeterminacy function  $I_A$  and non-membership function  $F_A$ . The lower and the upper approximations of  $A$  in the approximation  $(U, R)$  denoted by  $\underline{N}(A)$  and  $\overline{N}(A)$  are respectively defined as follows:

$$\underline{N}(A) = \{ \langle x, (T_{\underline{N}(A)}(x), I_{\underline{N}(A)}(x), F_{\underline{N}(A)}(x)) \rangle \mid y \in [x]_R, x \in U \},$$

$$\overline{N}(A) = \{ \langle x, (T_{\overline{N}(A)}(x), I_{\overline{N}(A)}(x), F_{\overline{N}(A)}(x)) \rangle \mid y \in [x]_R, x \in U \}$$

where

$$T_{\underline{N}(A)}(x) = \bigwedge_{y \in [x]_R} T_A(y), \quad I_{\underline{N}(A)}(x) = \bigvee_{y \in [x]_R} I_A(y), \quad F_{\underline{N}(A)}(x) = \bigvee_{y \in [x]_R} F_A(y),$$

$$T_{\overline{N}(A)}(x) = \bigvee_{y \in [x]_R} T_A(y), \quad I_{\overline{N}(A)}(x) = \bigwedge_{y \in [x]_R} I_A(y), \quad F_{\overline{N}(A)}(x) = \bigwedge_{y \in [x]_R} F_A(y).$$

such that,

$$T_{\underline{N}(A)}(x), I_{\underline{N}(A)}(x), F_{\underline{N}(A)}(x), T_{\overline{N}(A)}(x), I_{\overline{N}(A)}(x), F_{\overline{N}(A)}(x) : A \in [0, 1],$$

$$0 \leq T_{\underline{N}(A)}(x) + I_{\underline{N}(A)}(x) + F_{\underline{N}(A)}(x) \leq 3 \text{ and}$$

$$0 \leq T_{\overline{N}(A)}(x) + I_{\overline{N}(A)}(x) + F_{\overline{N}(A)}(x) \leq 3$$

Here  $\wedge$  and  $\vee$  denote “min” and “max” operators respectively, and  $[x]_R$  is the equivalence class of the  $x$ .  $T_A(y)$ ,  $I_A(y)$  and  $F_A(y)$  are the membership sequences, indeterminacy sequences and non-membership sequences of  $y$  with respect to  $A$ .

Since  $\underline{N}(A)$  and  $\overline{N}(A)$  are two neutrosophic sets in  $U$ , thus the neutrosophic set mappings  $\underline{N}, \overline{N} : N(U) \rightarrow N(U)$  are respectively referred as lower and upper rough neutrosophic set approximation operators, and the pair of  $(\underline{N}(A), \overline{N}(A))$  is called the rough neutrosophic set in  $(U, \mathcal{R})$ .

**Definition 2.4** ([1]) Let  $U$  be a non-null set and  $R$  be an equivalence relation on  $U$ . Let  $A$  be neutrosophic multisets in  $U$  with the truth-membership sequence  $T_A^i$ , indeterminacy-membership sequences  $I_A^i$  and falsity-membership sequences  $F_A^i$ . The lower and the upper approximations of  $A$  in the approximation  $(U, \mathcal{R})$  denoted by  $\underline{Nm}(A)$  and  $\overline{Nm}(A)$  are respectively defined as follows:

$$\underline{Nm} = \{ \langle x, (T_{\underline{Nm}(A)}^i(x), I_{\underline{Nm}(A)}^i(x), F_{\underline{Nm}(A)}^i(x)) \rangle \mid y \in [x]_R, x \in U \},$$

$$\overline{Nm}(A) = \{ \langle x, (T_{\overline{Nm}(A)}^i(x), I_{\overline{Nm}(A)}^i(x), F_{\overline{Nm}(A)}^i(x)) \rangle \mid y \in [x]_R, x \in U \}$$

where

$$i = 1, 2, \dots, p \text{ and positive integer}$$

$$T_{\underline{Nm}(A)}^i(x) = \bigwedge_{y \in [x]_R} T_A^i(y),$$

$$I_{\underline{Nm}(A)}^i(x) = \bigvee_{y \in [x]_R} I_A^i(y),$$

$$F_{\underline{Nm}(A)}^i(x) = \bigvee_{y \in [x]_R} F_A^i(y),$$

$$T_{\overline{Nm}(A)}^i(x) = \bigvee_{y \in [x]_R} T_A^i(y),$$

$$I_{\overline{Nm}(A)}^i(x) = \bigwedge_{y \in [x]_R} I_A^i(y),$$

$$F_{\overline{Nm}(A)}^i(x) = \bigwedge_{y \in [x]_R} F_A^i(y).$$

Here  $\wedge$  and  $\vee$  denote “min” and “max” operators respectively, and  $[x]_R$  is the equivalence class of the  $x$ .  $T_A^i(y)$ ,  $I_A^i(y)$  and  $F_A^i(y)$  are the membership sequences, indeterminacy sequences and non-membership sequences of  $y$  with respect to  $A$ .

It can be said that  $T_{Nm(A)}^i(x), I_{Nm(A)}^i(x), F_{Nm(A)}^i(x) \in [0, 1]$  and  $0 \leq T_{Nm(A)}^i(x) + I_{Nm(A)}^i(x) + F_{Nm(A)}^i(x) \leq 3$ . Then,  $Nm(A)$  is a neutrosophic multisets. Similarly, we have  $T_{\overline{Nm}(A)}^i(x), I_{\overline{Nm}(A)}^i(x), F_{\overline{Nm}(A)}^i(x) \in [0, 1]$  and  $0 \leq T_{\overline{Nm}(A)}^i(x) + I_{\overline{Nm}(A)}^i(x) + F_{\overline{Nm}(A)}^i(x) \leq 3$ . Then,  $\overline{Nm}(A)$  is neutrosophic multisets.

Since  $Nm(A)$  and  $\overline{Nm}(A)$  are two neutrosophic multisets in  $U$ , the neutrosophic multisets mappings  $Nm, \overline{Nm}: Nm(U) \rightarrow Nm(U)$  are respectively referred to as lower and upper rough neutrosophic multisets approximation operators, and the pair of  $(Nm(A), \overline{Nm}(A))$  is called the rough neutrosophic multisets in  $(U, \mathcal{R})$ , respectively.

### 3 Rough Neutrosophic Multisets Relation

The concept of a rough set can be easily extended to a relation since the relation is also a set, i.e. a subset of the Cartesian product. This concept is also used to define the rough neutrosophic multisets relation over the universe.

In the following section, the Cartesian product of two rough neutrosophic multisets is defined with some examples. We only considered the case where T, I, F are refined into the same number of subcomponents 1, 2, ...,  $p$ , and  $T_A^i, I_A^i$  and  $F_A^i$  are a single valued neutrosophic number. Some of the concepts are quoted from [2], [10], [12], [36]

**Definition 3.1** ([7]) Let  $A = (U, R)$  be an approximation space. Let  $X \subseteq U$ . A relation  $T$  on  $X$  is said to be a rough relation on  $X$  if  $\underline{T} \neq \overline{T}$ , where  $\underline{T}$  and  $\overline{T}$  are a lower and upper approximation of  $T$ , respectively defined by;

$$\begin{aligned} \underline{T} &= \{(x, y) \in U \times U: [x, y]_R \subseteq X\} \\ \overline{T} &= \{(x, y) \in U \times U: [x, y]_R \cap X \neq \emptyset\} \end{aligned}$$

**Definition 3.2** Let  $U$  be a non-empty set and  $X$  and  $Y$  be the rough neutrosophic multisets in  $U$ . Then, Cartesian product of  $X$  and  $Y$  is rough neutrosophic multisets in  $U \times U$ , denoted by  $X \times Y$ , defined as

$$X \times Y = \{ \langle (x, y), (T_{X \times Y}^i(x, y), I_{X \times Y}^i(x, y), F_{X \times Y}^i(x, y)) \rangle : (x, y) \in U \times U \}$$

where

$$\begin{aligned} T_{X \times Y}^i(x, y) &= \min\{T_X^i(x), T_Y^i(y)\}, \\ I_{X \times Y}^i(x, y) &= \max\{I_X^i(x), I_Y^i(y)\}, \\ F_{X \times Y}^i(x, y) &= \max\{F_X^i(x), F_Y^i(y)\}, \\ T_{X \times Y}^i, I_{X \times Y}^i, F_{X \times Y}^i: U &\rightarrow [0, 1], \text{ and } i = 1, 2, \dots, p. \end{aligned}$$

**Definition 3.3** Let  $U$  be a non-empty set and  $X$  and  $Y$  be the rough neutrosophic multisets in  $U$ . We call  $\mathfrak{R} \subseteq U \times U$  is a rough neutrosophic multisets relation on  $U \times U$  based on the  $X \times Y$ , where  $X \times Y$  is characterized by truth-membership sequence  $T_{\mathfrak{R}}^i$ , indeterminacy-membership sequences  $I_{\mathfrak{R}}^i$  and falsity-membership sequences  $F_{\mathfrak{R}}^i$ , defined as

$$\mathfrak{R} = \{ \langle (x, y), (T_{\mathfrak{R}}^i(x, y), I_{\mathfrak{R}}^i(x, y), F_{\mathfrak{R}}^i(x, y)) \rangle : (x, y) \in U \times U \}$$

with a condition if it satisfies:

- (1) i)  $T_{\mathfrak{R}}^i(x, y) = 1$  for all  $(x, y) \in X \times Y$  where  $X \times Y = \overline{\mathcal{R}_U}(X) \times \overline{\mathcal{R}_U}(Y)$ ,
- ii)  $T_{\mathfrak{R}}^i(x, y) = 0$ , for all  $(x, y) \in U \times U - \overline{X \times Y}$  where  $\overline{X \times Y} = \overline{\mathcal{R}_U}(X) \times \overline{\mathcal{R}_U}(Y)$ ,
- iii)  $0 < T_{\mathfrak{R}}^i(x, y) < 1$ , for all  $(x, y) \in \overline{X \times Y} - X \times Y$ .



- (2) i)  $I_{\mathfrak{R}}^i(x, y) = 0$ , for all  $(x, y) \in \underline{X} \times \underline{Y}$  where  $\underline{X} \times \underline{Y} = \underline{\mathcal{R}}_U(X) \times \underline{\mathcal{R}}_U(Y)$ ,
- ii)  $I_{\mathfrak{R}}^i(x, y) = 1$ , for all  $(x, y) \in U \times U - \overline{X} \times \overline{Y}$  where  $\overline{X} \times \overline{Y} = \overline{\mathcal{R}}_U(X) \times \overline{\mathcal{R}}_U(Y)$ ,
- iii)  $0 < I_{\mathfrak{R}}^i(x, y) < 1$ , for all  $(x, y) \in \overline{X} \times \overline{Y} - \underline{X} \times \underline{Y}$ .
- (3) i)  $F_{\mathfrak{R}}^i(x, y) = 0$ , for all  $(x, y) \in \underline{X} \times \underline{Y}$  where  $\underline{X} \times \underline{Y} = \underline{\mathcal{R}}_U(X) \times \underline{\mathcal{R}}_U(Y)$ ,
- ii)  $F_{\mathfrak{R}}^i(x, y) = 1$ , for all  $(x, y) \in U \times U - \overline{X} \times \overline{Y}$  where  $\overline{X} \times \overline{Y} = \overline{\mathcal{R}}_U(X) \times \overline{\mathcal{R}}_U(Y)$ ,
- iii)  $0 < F_{\mathfrak{R}}^i(x, y) < 1$ , for all  $(x, y) \in \overline{X} \times \overline{Y} - \underline{X} \times \underline{Y}$ .

**Remark 3.4:** The rough neutrosophic multisets relation is a relation on neutrosophic multisets, so we can consider that is a rough neutrosophic multisets relation over the universe. The rough neutrosophic multisets relation follows the condition of relation on neutrosophic multisets which is  $T_{\mathfrak{R}}^i(x, y) \leq T_{\underline{X} \times \underline{Y}}^i(x, y)$ ,  $I_{\mathfrak{R}}^i(x, y) \geq I_{\underline{X} \times \underline{Y}}^i(x, y)$ ,  $F_{\mathfrak{R}}^i(x, y) \geq F_{\underline{X} \times \underline{Y}}^i(x, y)$  for all  $(x, y) \in U \times U$ , and  $0 \leq T_{\mathfrak{R}}^i(x, y) + I_{\mathfrak{R}}^i(x, y) + F_{\mathfrak{R}}^i(x, y) \leq 3$ .

Therefore, the rough neutrosophic multisets relation will generalize the following relation:

(1) Rough Neutrosophic Set Relation

When  $i = 1$  for all element  $T, I, F$  in definition 3.2, we obtain the relation for rough neutrosophic set over universe;

$$\mathfrak{R} = \{ \langle (x, y), (T_{\mathfrak{R}}(x, y))(I_{\mathfrak{R}}(x, y)), (F_{\mathfrak{R}}(x, y)) \rangle : (x, y) \in U \times U \}.$$

(2) Rough Intuitionistic Fuzzy Set Relation

When  $i = 1$  for element  $T$  and  $F$ , and properties (2) in definition 3.3 is also omitted, we obtain the relation for rough intuitionistic fuzzy set over universe;

$$\mathfrak{R} = \{ \langle (x, y), (T_{\mathfrak{R}}(x, y)), (F_{\mathfrak{R}}(x, y)) \rangle : (x, y) \in U \times U \}.$$

(3) Rough Fuzzy Set Relation

When  $i = 1$  for element  $T$  and properties (2) and (3) in definition 3.3 is also omitted, we obtain the relation for rough fuzzy set over universe;

$$\mathfrak{R} = \{ \langle (x, y), (T_{\mathfrak{R}}(x, y)) \rangle : (x, y) \in U \times U \}.$$

The rough neutrosophic multisets relation can be presented by relational tables and matrices, like a representation of fuzzy relation. Since the triple  $(T_A^i, I_A^i, F_A^i)$  has values within the interval  $[0, 1]$ , the elements of the neutrosophic matrix also have values within  $[0, 1]$ . Consider the following example:

**Example 3.5:** Let  $U = \{u_1, u_2, u_3\}$  be a universal set and  $\mathcal{R}_U = (x, y): x\mathcal{R}_U y$  is equivalent relations on  $U$ . Let

$$X = \frac{(1,0.3),(0.4,0.7),(0.6,0.8)}{u_1} + \frac{(0.5,0.7),(0.1,0.3),(0.4,0.5)}{u_2} + \frac{(1,0.6),(0.4,0.5),(0.6,0.7)}{u_3}, \text{ and}$$

$$Y = \frac{(0.4,0.6),(0.3,0.5),(0.1,0.7)}{u_1} + \frac{(0.5,0.4),(0.1,0.7),(0.3,0.8)}{u_2} + \frac{(1,0.7),(0.2,0.5),(0.1,0.7)}{u_3}$$

are rough neutrosophic multisets on  $U$ .

Here we can define a rough neutrosophic multisets relation  $\mathfrak{R}$  by a matrix.  $x\mathcal{R}_U y$  is composed by  $\mathcal{R}_U = \{\{u_1, u_3\}, \{u_2\}\}$ . Based on definition 2.4 and 3.2, we solve for;

$$\underline{\mathcal{R}}_U(X) = \frac{(1,0.3),(0.4,0.7),(0.6,0.8)}{u_1} + \frac{(0.5,0.7),(0.1,0.3),(0.4,0.5)}{u_2} + \frac{(1,0.3),(0.4,0.7),(0.6,0.8)}{u_3},$$

$$\overline{\mathcal{R}}_U(X) = \frac{(1,0.6),(0.4,0.5),(0.6,0.7)}{u_1} + \frac{(0.5,0.7),(0.1,0.3),(0.4,0.5)}{u_2} + \frac{(1,0.6),(0.4,0.5),(0.6,0.7)}{u_3},$$

$$\underline{\mathcal{R}}_U(Y) = \frac{(0.4,0.6),(0.3,0.5),(0.1,0.7)}{u_1} + \frac{(0.5,0.4),(0.1,0.7),(0.3,0.8)}{u_2} + \frac{(0.4,0.6),(0.3,0.5),(0.1,0.7)}{u_3},$$

$$\overline{\mathcal{R}}_U(Y) = \frac{(1,0.7),(0.2,0.5),(0.1,0.7)}{u_1} + \frac{(0.5,0.4),(0.1,0.7),(0.3,0.8)}{u_2} + \frac{(1,0.7),(0.2,0.5),(0.1,0.7)}{u_3}$$

We have  $\underline{X} \times \underline{Y} = \underline{\mathcal{R}}_U(X) \times \underline{\mathcal{R}}_U(Y)$  and  $\overline{X} \times \overline{Y} = \overline{\mathcal{R}}_U(X) \times \overline{\mathcal{R}}_U(Y)$ . Then, by satisfied all the condition in definition 3.3, we defined  $\mathfrak{R} \subseteq U \times U$  as a rough neutrosophic multisets relation on  $U \times U$  based on the  $X \times Y$  by a matrix form:

$$M(\mathfrak{R}) = \begin{bmatrix} (0.3, 0), (1, 1), (1, 1) & (0, 0), (1, 1), (1, 1) & (0.9, 0), (1, 1), (1, 1) \\ (0, 0), (1, 1), (1, 1) & (0, 0), (1, 1), (1, 1) & (0, 0), (1, 1), (1, 1) \\ (0.4, 0), (1, 1), (1, 1) & (0, 0), (1, 1), (1, 1) & (0.9, 0), (1, 1), (1, 1) \end{bmatrix}$$

Now, we consider some properties of a rough neutrosophic multisets relation.

**Proposition 3.6** Let  $\mathfrak{R}_1, \mathfrak{R}_2$  be two rough neutrosophic multisets relation on  $U \times U$  based on the  $X \times Y$ . Then  $\mathfrak{R}_1 \wedge \mathfrak{R}_2$  where

$$T_{\mathfrak{R}_1 \wedge \mathfrak{R}_2}^i(x, y) = \min\{T_{\mathfrak{R}_1}^i(x, y), T_{\mathfrak{R}_2}^i(x, y)\},$$

$$I_{\mathfrak{R}_1 \wedge \mathfrak{R}_2}^i(x, y) = \max\{I_{\mathfrak{R}_1}^i(x, y), I_{\mathfrak{R}_2}^i(x, y)\},$$

$$F_{\mathfrak{R}_1 \wedge \mathfrak{R}_2}^i(x, y) = \max\{F_{\mathfrak{R}_1}^i(x, y), F_{\mathfrak{R}_2}^i(x, y)\}$$

for all  $(x, y) \in U \times U$ , is a rough neutrosophic multisets on  $U \times U$  based on the  $X \times Y$  and  $i = 1, 2, \dots, p$ .

**Proof:** We show that  $\mathfrak{R}_1 \wedge \mathfrak{R}_2$  satisfy definition 3.3.

- (1) i) Since  $T_{\mathfrak{R}_1}^i(x, y) = T_{\mathfrak{R}_2}^i(x, y) = 1$  for all  $(x, y) \in \underline{X} \times \underline{Y}$  then  
 $T_{\mathfrak{R}_1 \wedge \mathfrak{R}_2}^i(x, y) = \min\{T_{\mathfrak{R}_1}^i(x, y), T_{\mathfrak{R}_2}^i(x, y)\} = 1$  for all  $(x, y) \in \underline{X} \times \underline{Y}$ .
- ii) Since  $T_{\mathfrak{R}_1}^i(x, y) = T_{\mathfrak{R}_2}^i(x, y) = 0$  for all  $(x, y) \in U \times U - \overline{X} \times \overline{Y}$   
then  $T_{\mathfrak{R}_1 \wedge \mathfrak{R}_2}^i(x, y) = \min\{T_{\mathfrak{R}_1}^i(x, y), T_{\mathfrak{R}_2}^i(x, y)\} = 0$  for all  $(x, y) \in U \times U - \overline{X} \times \overline{Y}$ .
- iii) Since  $0 < T_{\mathfrak{R}_1}^i(x, y), T_{\mathfrak{R}_2}^i(x, y) < 1$ , for all  $(x, y) \in \overline{X} \times \overline{Y} - \underline{X} \times \underline{Y}$  then  
 $0 < T_{\mathfrak{R}_1 \wedge \mathfrak{R}_2}^i(x, y) = \min\{T_{\mathfrak{R}_1}^i(x, y), T_{\mathfrak{R}_2}^i(x, y)\} < 1$  for all  $(x, y) \in \overline{X} \times \overline{Y} - \underline{X} \times \underline{Y}$ .
- (2) i) Since  $I_{\mathfrak{R}_1}^i(x, y) = I_{\mathfrak{R}_2}^i(x, y) = 0$  for all  $(x, y) \in \underline{X} \times \underline{Y}$  then  
 $I_{\mathfrak{R}_1 \wedge \mathfrak{R}_2}^i(x, y) = \max\{I_{\mathfrak{R}_1}^i(x, y), I_{\mathfrak{R}_2}^i(x, y)\} = 0$  for all  $(x, y) \in \underline{X} \times \underline{Y}$ .
- ii) Since  $I_{\mathfrak{R}_1}^i(x, y) = I_{\mathfrak{R}_2}^i(x, y) = 1$  for all  $(x, y) \in U \times U - \overline{X} \times \overline{Y}$   
then  $I_{\mathfrak{R}_1 \wedge \mathfrak{R}_2}^i(x, y) = \max\{I_{\mathfrak{R}_1}^i(x, y), I_{\mathfrak{R}_2}^i(x, y)\} = 1$  for all  $(x, y) \in U \times U - \overline{X} \times \overline{Y}$ .
- iii) Since  $0 < I_{\mathfrak{R}_1}^i(x, y), I_{\mathfrak{R}_2}^i(x, y) < 1$ , for all  $(x, y) \in \overline{X} \times \overline{Y} - \underline{X} \times \underline{Y}$  then  
 $0 < I_{\mathfrak{R}_1 \wedge \mathfrak{R}_2}^i(x, y) = \max\{I_{\mathfrak{R}_1}^i(x, y), I_{\mathfrak{R}_2}^i(x, y)\} < 1$  for all  $(x, y) \in \overline{X} \times \overline{Y} - \underline{X} \times \underline{Y}$ .

Proof (3) for falsity function are similarly to proving (2) for indeterminate function.

**Proposition 3.7** Let  $\mathfrak{R}_1, \mathfrak{R}_2$  be two rough neutrosophic multisets relation on  $U \times U$  based on the  $X \times Y$ . Then  $\mathfrak{R}_1 \vee \mathfrak{R}_2$  where

$$T_{\mathfrak{R}_1 \vee \mathfrak{R}_2}^i(x, y) = \max\{T_{\mathfrak{R}_1}^i(x, y), T_{\mathfrak{R}_2}^i(x, y)\},$$

$$I_{\mathfrak{R}_1 \vee \mathfrak{R}_2}^i(x, y) = \min\{I_{\mathfrak{R}_1}^i(x, y), I_{\mathfrak{R}_2}^i(x, y)\},$$

$$F_{\mathfrak{R}_1 \vee \mathfrak{R}_2}^i(x, y) = \min\{F_{\mathfrak{R}_1}^i(x, y), F_{\mathfrak{R}_2}^i(x, y)\}$$

for all  $(x, y) \in U \times U$ , is a rough neutrosophic multisets on  $U \times U$  based on the  $X \times Y$  and  $i = 1, 2, \dots, p$ .

**Proof:** We show that  $\mathfrak{R}_1 \vee \mathfrak{R}_2$  satisfy definition 3.3.

- (1) i) Since  $T_{\mathfrak{R}_1}^i(x, y) = T_{\mathfrak{R}_2}^i(x, y) = 1$  for all  $(x, y) \in \underline{X} \times \underline{Y}$  then  
 $T_{\mathfrak{R}_1 \vee \mathfrak{R}_2}^i(x, y) = \max\{T_{\mathfrak{R}_1}^i(x, y), T_{\mathfrak{R}_2}^i(x, y)\} = 1$  for all  $(x, y) \in \underline{X} \times \underline{Y}$ .
- ii) Since  $T_{\mathfrak{R}_1}^i(x, y) = T_{\mathfrak{R}_2}^i(x, y) = 0$  for all  $(x, y) \in U \times U - \overline{X} \times \overline{Y}$   
then  $T_{\mathfrak{R}_1 \vee \mathfrak{R}_2}^i(x, y) = \max\{T_{\mathfrak{R}_1}^i(x, y), T_{\mathfrak{R}_2}^i(x, y)\} = 0$  for all  $(x, y) \in U \times U - \overline{X} \times \overline{Y}$ .
- iii) Since  $0 < T_{\mathfrak{R}_1}^i(x, y), T_{\mathfrak{R}_2}^i(x, y) < 1$ , for all  $(x, y) \in \overline{X} \times \overline{Y} - \underline{X} \times \underline{Y}$  then  
 $0 < T_{\mathfrak{R}_1 \vee \mathfrak{R}_2}^i(x, y) = \max\{T_{\mathfrak{R}_1}^i(x, y), T_{\mathfrak{R}_2}^i(x, y)\} < 1$  for all  $(x, y) \in \overline{X} \times \overline{Y} - \underline{X} \times \underline{Y}$ .

- (2) i) Since  $I_{\mathfrak{R}_1}^i(x, y) = I_{\mathfrak{R}_2}^i(x, y) = 0$  for all  $(x, y) \in \underline{X \times Y}$  then  
 $I_{\mathfrak{R}_1 \vee \mathfrak{R}_2}^i(x, y) = \min\{I_{\mathfrak{R}_1}^i(x, y), I_{\mathfrak{R}_2}^i(x, y)\} = 0$  for all  $(x, y) \in \underline{X \times Y}$ .
- ii) Since  $I_{\mathfrak{R}_1}^i(x, y) = I_{\mathfrak{R}_2}^i(x, y) = 1$  for all  $(x, y) \in U \times U - \overline{X \times Y}$   
then  $I_{\mathfrak{R}_1 \vee \mathfrak{R}_2}^i(x, y) = \min\{I_{\mathfrak{R}_1}^i(x, y), I_{\mathfrak{R}_2}^i(x, y)\} = 1$  for all  $(x, y) \in U \times U - \overline{X \times Y}$ .
- iii) Since  $0 < I_{\mathfrak{R}_1}^i(x, y), I_{\mathfrak{R}_2}^i(x, y) < 1$ , for all  $(x, y) \in \overline{X \times Y} - \underline{X \times Y}$  then  
 $0 < I_{\mathfrak{R}_1 \vee \mathfrak{R}_2}^i(x, y) = \min\{I_{\mathfrak{R}_1}^i(x, y), I_{\mathfrak{R}_2}^i(x, y)\} < 1$  for all  $(x, y) \in \overline{X \times Y} - \underline{X \times Y}$ .

Proof (3) for falsity function are similarly to proving (2) for indeterminate function.

**Lemma 3.8:** If  $0 < x, y < 1$ , then

- (i)  $0 < xy < 1$ ,  
(ii)  $0 < x + y - xy < 1$ .

Since  $0 < x, y < 1$  then  $x + y \geq 2\sqrt{xy} > 2xy > xy > 0$ , therefore  $x + y - xy > 0$ . On the other hand,  $1 - (x + y - xy) = (1 - x)(1 - y) > 0$  then  $x + y - xy < 1$ . The following properties of a rough neutrosophic multisets relation are obtained by using these algebraic results.

**Proposition 3.9** Let  $\mathfrak{R}_1, \mathfrak{R}_2$  be two rough neutrosophic multisets relation on  $U \times U$  based on the  $X \times Y$ . Then  $\mathfrak{R}_1 \otimes \mathfrak{R}_2$  where

$$T_{\mathfrak{R}_1 \otimes \mathfrak{R}_2}^i(x, y) = T_{\mathfrak{R}_1}^i(x, y) \cdot T_{\mathfrak{R}_2}^i(x, y),$$

$$I_{\mathfrak{R}_1 \otimes \mathfrak{R}_2}^i(x, y) = I_{\mathfrak{R}_1}^i(x, y) + I_{\mathfrak{R}_2}^i(x, y) - I_{\mathfrak{R}_1}^i(x, y) \cdot I_{\mathfrak{R}_2}^i(x, y)$$

$$F_{\mathfrak{R}_1 \otimes \mathfrak{R}_2}^i(x, y) = F_{\mathfrak{R}_1}^i(x, y) + F_{\mathfrak{R}_2}^i(x, y) - F_{\mathfrak{R}_1}^i(x, y) \cdot F_{\mathfrak{R}_2}^i(x, y)$$

for all  $(x, y) \in U \times U$ , is a rough neutrosophic multisets on  $U \times U$  based on the  $X \times Y$  and  $i = 1, 2, \dots, p$ .

**Proof:** The relation  $\mathfrak{R}_1 \otimes \mathfrak{R}_2$  satisfied definition 3.3. Indeed:

- (1) i) Since  $T_{\mathfrak{R}_1}^i(x, y) = T_{\mathfrak{R}_2}^i(x, y) = 1$  for all  $(x, y) \in \underline{X \times Y}$  then  
 $T_{\mathfrak{R}_1 \otimes \mathfrak{R}_2}^i(x, y) = T_{\mathfrak{R}_1}^i(x, y) \cdot T_{\mathfrak{R}_2}^i(x, y) = 1$  for all  $(x, y) \in \underline{X \times Y}$ .
- ii) Since  $T_{\mathfrak{R}_1}^i(x, y) = T_{\mathfrak{R}_2}^i(x, y) = 0$  for all  $(x, y) \in U \times U - \overline{X \times Y}$   
then  $T_{\mathfrak{R}_1 \otimes \mathfrak{R}_2}^i(x, y) = T_{\mathfrak{R}_1}^i(x, y) \cdot T_{\mathfrak{R}_2}^i(x, y) = 0$  for all  $(x, y) \in U \times U - \overline{X \times Y}$ .
- iii) Since  $0 < T_{\mathfrak{R}_1}^i(x, y), T_{\mathfrak{R}_2}^i(x, y) < 1$ , for all  $(x, y) \in \overline{X \times Y} - \underline{X \times Y}$  then  
 $0 < T_{\mathfrak{R}_1 \otimes \mathfrak{R}_2}^i(x, y) = T_{\mathfrak{R}_1}^i(x, y) \cdot T_{\mathfrak{R}_2}^i(x, y) < 1$  for all  $(x, y) \in \overline{X \times Y} - \underline{X \times Y}$  (Lemma 3.8 (i)).
- (2) i) Since  $I_{\mathfrak{R}_1}^i(x, y) = I_{\mathfrak{R}_2}^i(x, y) = 0$  for all  $(x, y) \in \underline{X \times Y}$  then  
 $I_{\mathfrak{R}_1 \otimes \mathfrak{R}_2}^i(x, y) = I_{\mathfrak{R}_1}^i(x, y) + I_{\mathfrak{R}_2}^i(x, y) - I_{\mathfrak{R}_1}^i(x, y) \cdot I_{\mathfrak{R}_2}^i(x, y) = 0$  for all  $(x, y) \in \underline{X \times Y}$ .
- ii) Since  $I_{\mathfrak{R}_1}^i(x, y) = I_{\mathfrak{R}_2}^i(x, y) = 1$  for all  $(x, y) \in U \times U - \overline{X \times Y}$  then  $I_{\mathfrak{R}_1 \otimes \mathfrak{R}_2}^i(x, y) = I_{\mathfrak{R}_1}^i(x, y) + I_{\mathfrak{R}_2}^i(x, y) - I_{\mathfrak{R}_1}^i(x, y) \cdot I_{\mathfrak{R}_2}^i(x, y) = 1$  for all  $(x, y) \in U \times U - \overline{X \times Y}$ .
- iii) Since  $0 < I_{\mathfrak{R}_1}^i(x, y), I_{\mathfrak{R}_2}^i(x, y) < 1$ , for all  $(x, y) \in \overline{X \times Y} - \underline{X \times Y}$  then  
 $0 < I_{\mathfrak{R}_1 \otimes \mathfrak{R}_2}^i(x, y) = I_{\mathfrak{R}_1}^i(x, y) + I_{\mathfrak{R}_2}^i(x, y) - I_{\mathfrak{R}_1}^i(x, y) \cdot I_{\mathfrak{R}_2}^i(x, y) < 1$  for all  $(x, y) \in \overline{X \times Y} - \underline{X \times Y}$  (Lemma 3.8 (ii)).

Proof (3) for falsity function are similarly to proving (2) for indeterminate function.

**Proposition 3.10** Let  $\mathfrak{R}_1, \mathfrak{R}_2$  be two rough neutrosophic multisets relation on  $U \times U$  based on the  $X \times Y$ . Then  $\mathfrak{R}_1 \oplus \mathfrak{R}_2$  where

$$T_{\mathfrak{R}_1 \oplus \mathfrak{R}_2}^i(x, y) = T_{\mathfrak{R}_1}^i(x, y) + T_{\mathfrak{R}_2}^i(x, y) - T_{\mathfrak{R}_1}^i(x, y) \cdot T_{\mathfrak{R}_2}^i(x, y),$$

$$I_{\mathfrak{R}_1 \oplus \mathfrak{R}_2}^i(x, y) = I_{\mathfrak{R}_1}^i(x, y) \cdot I_{\mathfrak{R}_2}^i(x, y),$$

$$F_{\mathfrak{R}_1 \oplus \mathfrak{R}_2}^i(x, y) = F_{\mathfrak{R}_1}^i(x, y) \cdot F_{\mathfrak{R}_2}^i(x, y)$$

for all  $(x, y) \in U \times U$ , is a rough neutrosophic multisets on  $U \times U$  based on the  $X \times Y$  and  $i = 1, 2, \dots, p$ .

**Proof:** The relation  $\mathfrak{R}_1 \oplus \mathfrak{R}_2$  satisfied definition 3.3. Indeed:

- (1) i) Since  $T_{\mathfrak{R}_1}^i(x, y) = T_{\mathfrak{R}_2}^i(x, y) = 1$  for all  $(x, y) \in \underline{X} \times \underline{Y}$  then  
 $T_{\mathfrak{R}_1 \oplus \mathfrak{R}_2}^i(x, y) = T_{\mathfrak{R}_1}^i(x, y) + T_{\mathfrak{R}_2}^i(x, y) - T_{\mathfrak{R}_1}^i(x, y) \cdot T_{\mathfrak{R}_2}^i(x, y) = 1$  for all  $(x, y) \in \underline{X} \times \underline{Y}$ .
  - ii) Since  $T_{\mathfrak{R}_1}^i(x, y) = T_{\mathfrak{R}_2}^i(x, y) = 0$  for all  $(x, y) \in U \times U - \overline{X} \times \overline{Y}$  then  $T_{\mathfrak{R}_1 \oplus \mathfrak{R}_2}^i(x, y) = T_{\mathfrak{R}_1}^i(x, y) + T_{\mathfrak{R}_2}^i(x, y) - T_{\mathfrak{R}_1}^i(x, y) \cdot T_{\mathfrak{R}_2}^i(x, y) = 0$  for all  $(x, y) \in U \times U - \overline{X} \times \overline{Y}$ .
  - iii) Since  $0 < T_{\mathfrak{R}_1}^i(x, y), T_{\mathfrak{R}_2}^i(x, y) < 1$ , for all  $(x, y) \in \overline{X} \times \overline{Y} - \underline{X} \times \underline{Y}$  then  
 $0 < T_{\mathfrak{R}_1 \oplus \mathfrak{R}_2}^i(x, y) = T_{\mathfrak{R}_1}^i(x, y) + T_{\mathfrak{R}_2}^i(x, y) - T_{\mathfrak{R}_1}^i(x, y) \cdot T_{\mathfrak{R}_2}^i(x, y) < 1$  for all  $(x, y) \in \overline{X} \times \overline{Y} - \underline{X} \times \underline{Y}$  (Lemma 3.8 (ii)).
- (2) i) Since  $I_{\mathfrak{R}_1}^i(x, y) = I_{\mathfrak{R}_2}^i(x, y) = 0$  for all  $(x, y) \in \underline{X} \times \underline{Y}$  then  
 $I_{\mathfrak{R}_1 \oplus \mathfrak{R}_2}^i(x, y) = I_{\mathfrak{R}_1}^i(x, y) \cdot I_{\mathfrak{R}_2}^i(x, y) = 0$  for all  $(x, y) \in \underline{X} \times \underline{Y}$ .
  - ii) Since  $I_{\mathfrak{R}_1}^i(x, y) = I_{\mathfrak{R}_2}^i(x, y) = 1$  for all  $(x, y) \in U \times U - \overline{X} \times \overline{Y}$  then  $I_{\mathfrak{R}_1 \oplus \mathfrak{R}_2}^i(x, y) = I_{\mathfrak{R}_1}^i(x, y) \cdot I_{\mathfrak{R}_2}^i(x, y) = 1$  for all  $(x, y) \in U \times U - \overline{X} \times \overline{Y}$ .
  - iii) Since  $0 < I_{\mathfrak{R}_1}^i(x, y), I_{\mathfrak{R}_2}^i(x, y) < 1$ , for all  $(x, y) \in \overline{X} \times \overline{Y} - \underline{X} \times \underline{Y}$  then  
 $0 < I_{\mathfrak{R}_1 \oplus \mathfrak{R}_2}^i(x, y) = I_{\mathfrak{R}_1}^i(x, y) \cdot I_{\mathfrak{R}_2}^i(x, y) < 1$  for all  $(x, y) \in \overline{X} \times \overline{Y} - \underline{X} \times \underline{Y}$  (Lemma 3.8 (i)).

Proof (3) for falsity function are similarly to proving (2) for indeterminate function.

### 3.1 Composition of Two Rough Neutrosophic Multisets Relation

The composition of relation is important for applications because if a relation on  $X$  and  $Y$  is known and if a relation on  $Y$  and  $Z$  is known, then the relation on  $X$  and  $Z$  could be computed over a universe with the useful significance.

**Definition 3.1.1** Let  $U$  be a non-empty set and  $X, Y$  and  $Z$  are the rough neutrosophic multisets in  $U$ . Let  $\mathfrak{R}_1, \mathfrak{R}_2$  are two rough neutrosophic multisets relations on  $U \times U$ , based on  $X \times Y, Y \times Z$ , respectively. The composition of  $\mathfrak{R}_1, \mathfrak{R}_2$  denote as  $\mathfrak{R}_1 \circ \mathfrak{R}_2$  which defined on  $U \times U$  based on  $X \times Z$  where

$$T_{\mathfrak{R}_1 \circ \mathfrak{R}_2}^i(x, z) = \max_{y \in U} \{ \min [ T_{\mathfrak{R}_1}^i(x, y), T_{\mathfrak{R}_2}^i(y, z) ] \},$$

$$I_{\mathfrak{R}_1 \circ \mathfrak{R}_2}^i(x, z) = \min_{y \in U} \{ \max [ I_{\mathfrak{R}_1}^i(x, y), I_{\mathfrak{R}_2}^i(y, z) ] \},$$

$$F_{\mathfrak{R}_1 \circ \mathfrak{R}_2}^i(x, z) = \min_{y \in U} \{ \max [ F_{\mathfrak{R}_1}^i(x, y), F_{\mathfrak{R}_2}^i(y, z) ] \}.$$

for all  $(x, z) \in U \times U$  and  $i = 1, 2, \dots, p$ .

**Proposition 3.1.2**  $\mathfrak{R}_1 \circ \mathfrak{R}_2$  is a rough neutrosophic multisets relation on  $U \times U$  based on  $X \times Z$ .

**Proof:** Since  $\mathfrak{R}_1, \mathfrak{R}_2$  are two rough neutrosophic multisets relations on  $U \times U$  based on  $X \times Y, Y \times Z$  respectively;

- (1) i) Then  $T_{\mathfrak{R}_1}^i(x, z) = 1 = T_{\mathfrak{R}_2}^i(x, z)$  for all  $(x, z) \in \underline{X} \times \underline{Z}$ . Let  $(x, z) \in \underline{X} \times \underline{Z}$ , now  
 $T_{\mathfrak{R}_1 \circ \mathfrak{R}_2}^i(x, z) = \max_{y \in U} \{ \min [ T_{\mathfrak{R}_1}^i(x, y), T_{\mathfrak{R}_2}^i(y, z) ] \} = 1$ . This holds for all  $(x, z) \in \underline{X} \times \underline{Z}$ .
  - ii) Let  $(x, z) \in U \times U - \overline{X} \times \overline{Z}$ . So,  $T_{\mathfrak{R}_1}^i(x, z) = 0 = T_{\mathfrak{R}_2}^i(x, z)$  for all  $(x, z) \in U \times U - \overline{X} \times \overline{Z}$ .  
Then  $T_{\mathfrak{R}_1 \circ \mathfrak{R}_2}^i(x, z) = \max_{y \in U} \{ \min [ T_{\mathfrak{R}_1}^i(x, y), T_{\mathfrak{R}_2}^i(y, z) ] \} = 0$  for all  $(x, z) \in U \times U - \overline{X} \times \overline{Z}$ .
  - iii) Again, since  $0 < T_{\mathfrak{R}_1}^i(x, z), T_{\mathfrak{R}_2}^i(x, z) < 1$ , for all  $(x, z) \in \overline{X} \times \overline{Z} - \underline{X} \times \underline{Z}$ ,  
then  $0 < \max_{y \in U} \{ \min [ T_{\mathfrak{R}_1}^i(x, y), T_{\mathfrak{R}_2}^i(y, z) ] \} < 1$  such that  $0 < T_{\mathfrak{R}_1 \circ \mathfrak{R}_2}^i(x, z) < 1$  for all  $(x, z) \in \overline{X} \times \overline{Z} - \underline{X} \times \underline{Z}$ .
- (2) i) Then  $I_{\mathfrak{R}_1}^i(x, z) = 0 = I_{\mathfrak{R}_2}^i(x, z)$  for all  $(x, z) \in \underline{X} \times \underline{Z}$ . Let  $(x, z) \in \underline{X} \times \underline{Z}$ , now  
 $I_{\mathfrak{R}_1 \circ \mathfrak{R}_2}^i(x, z) = \min_{y \in U} \{ \max [ I_{\mathfrak{R}_1}^i(x, y), I_{\mathfrak{R}_2}^i(y, z) ] \} = 0$ . This holds for all  $(x, z) \in \underline{X} \times \underline{Z}$ .

- ii) Let  $(x, z) \in U \times U - \overline{X \times Z}$ . So,  $I_{\mathfrak{R}_1}^i(x, z) = 1 = I_{\mathfrak{R}_2}^i(x, z)$  for all  $(x, z) \in U \times U - \overline{X \times Z}$ . Then  $I_{\mathfrak{R}_1 \circ \mathfrak{R}_2}^i(x, z) = \min_{y \in U} \{ \max [ I_{\mathfrak{R}_1}^i(x, y), I_{\mathfrak{R}_2}^i(y, z) ] \} = 1$  for all  $(x, z) \in U \times U - \overline{X \times Z}$ .
- iii) Again, since  $0 < I_{\mathfrak{R}_1}^i(x, z), I_{\mathfrak{R}_2}^i(x, z) < 1$ , for all  $(x, z) \in \overline{X \times Z} - X \times Z$ , then  $0 < \min_{y \in U} \{ \max [ I_{\mathfrak{R}_1}^i(x, y), I_{\mathfrak{R}_2}^i(y, z) ] \} < 1$  such that  $0 < I_{\mathfrak{R}_1 \circ \mathfrak{R}_2}^i(x, z) < 1$  for all  $(x, z) \in \overline{X \times Z} - X \times Z$ .

Proof (3) for falsity function are similarly to proving (2) for indeterminate function.

**Proposition 3.1.3** Let  $U$  be a non-empty set.  $\mathfrak{R}_1, \mathfrak{R}_2, \mathfrak{R}_3$  are rough neutrosophic multisets relations on  $U \times U$  based on  $X \times Y, Y \times Z, Z \times Z'$ , respectively. Then  $(\mathfrak{R}_1 \circ \mathfrak{R}_2) \circ \mathfrak{R}_3 = \mathfrak{R}_1 \circ (\mathfrak{R}_2 \circ \mathfrak{R}_3)$

**Proof:** We only proof for truth function. For all  $x, y, z, t \in U$  we have

$$\begin{aligned} T_{\mathfrak{R}_1 \circ (\mathfrak{R}_2 \circ \mathfrak{R}_3)}^i(x, t) &= \max_{y \in U} \{ \min [ T_{\mathfrak{R}_1}^i(x, y), T_{(\mathfrak{R}_2 \circ \mathfrak{R}_3)}^i(y, t) ] \} \\ &= \max_{y \in U} \{ \min [ T_{\mathfrak{R}_1}^i(x, y), \max_{z \in U} \{ \min [ T_{\mathfrak{R}_2}^i(y, z), T_{\mathfrak{R}_3}^i(z, t) ] \} ] \} \\ &= \max_{z \in U} \{ \min [ \max_{y \in U} \{ \min [ T_{\mathfrak{R}_1}^i(x, y), T_{\mathfrak{R}_2}^i(y, z) ] \}, T_{\mathfrak{R}_3}^i(z, t) ] \} \\ &= \max_{z \in U} \{ \min [ T_{(\mathfrak{R}_1 \circ \mathfrak{R}_2)}^i(x, y), T_{\mathfrak{R}_3}^i(y, t) ] \} \\ &= T_{(\mathfrak{R}_1 \circ \mathfrak{R}_2) \circ \mathfrak{R}_3}^i(x, t); \end{aligned}$$

Similarly proof for indeterminate function and falsity function.

Note that  $\mathfrak{R}_1 \circ \mathfrak{R}_2 \neq \mathfrak{R}_2 \circ \mathfrak{R}_1$ , since the composition of two rough neutrosophic multisets relations  $\mathfrak{R}_1, \mathfrak{R}_2$  exists, the composition of two rough neutrosophic multisets relations  $\mathfrak{R}_2, \mathfrak{R}_1$  does not necessarily exist.

### 3.2 Inverse Rough Neutrosophic Multisets Relation

**Definition 3.2.1** Let  $U$  be a non-empty set and  $X$  and  $Y$  be the rough neutrosophic multisets in  $U$ .  $\mathfrak{R} \subseteq U \times U$  is a rough neutrosophic multisets relation on  $U \times U$  based on the  $X \times Y$ . Then, we define  $\mathfrak{R}^{-1} \subseteq U \times U$  is the rough neutrosophic multisets relation on  $U \times U$  based on  $Y \times X$  as follows:

$$\mathfrak{R}^{-1} = \left\{ < (y, x), \left( T_{\mathfrak{R}^{-1}}^i(y, x) \right) \left( I_{\mathfrak{R}^{-1}}^i(y, x) \right), \left( F_{\mathfrak{R}^{-1}}^i(y, x) \right) > : (y, x) \in U \times U \right\}$$

where

$$T_{\mathfrak{R}^{-1}}^i(y, x) = T_{\mathfrak{R}}^i(x, y), I_{\mathfrak{R}^{-1}}^i(y, x) = I_{\mathfrak{R}}^i(x, y), F_{\mathfrak{R}^{-1}}^i(y, x) = F_{\mathfrak{R}}^i(x, y)$$

for all  $(y, x) \in U \times U$  and  $i = 1, 2, \dots, p$ .

**Definition 3.2.2** The relation  $\mathfrak{R}^{-1}$  is called the inverse rough neutrosophic multisets relation of  $\mathfrak{R}$ .

**Proposition 3.2.3**  $(\mathfrak{R}^{-1})^{-1} = \mathfrak{R}$ .

**Proof:** From definition 3.3;

- (1) i)  $T_{(\mathfrak{R}^{-1})^{-1}}^i(x, y) = T_{\mathfrak{R}^{-1}}^i(y, x) = T_{\mathfrak{R}}^i(x, y) = 1$  for all  $(x, y) \in X \times Y$   
 ii)  $T_{(\mathfrak{R}^{-1})^{-1}}^i(x, y) = T_{\mathfrak{R}^{-1}}^i(y, x) = T_{\mathfrak{R}}^i(x, y) = 0$  for all  $(x, y) \in U \times U - \overline{X \times Y}$   
 iii)  $0 < T_{(\mathfrak{R}^{-1})^{-1}}^i(x, y) = T_{\mathfrak{R}^{-1}}^i(y, x) = T_{\mathfrak{R}}^i(x, y) < 1$  for all  $(x, y) \in \overline{X \times Y} - X \times Y$
- (2) i)  $I_{(\mathfrak{R}^{-1})^{-1}}^i(x, y) = I_{\mathfrak{R}^{-1}}^i(y, x) = I_{\mathfrak{R}}^i(x, y) = 0$  for all  $(x, y) \in X \times Y$   
 ii)  $I_{(\mathfrak{R}^{-1})^{-1}}^i(x, y) = I_{\mathfrak{R}^{-1}}^i(y, x) = I_{\mathfrak{R}}^i(x, y) = 1$  for all  $(x, y) \in U \times U - \overline{X \times Y}$   
 iii)  $0 < I_{(\mathfrak{R}^{-1})^{-1}}^i(x, y) = I_{\mathfrak{R}^{-1}}^i(y, x) = I_{\mathfrak{R}}^i(x, y) < 1$  for all  $(x, y) \in \overline{X \times Y} - X \times Y$

Proof (3) for falsity function are similarly to proving (2) for indeterminate function.

It means  $(\mathfrak{R}^{-1})^{-1} = \mathfrak{R}$ .

**Proposition 3.2.4** Let  $\mathfrak{R}_1, \mathfrak{R}_2$  be two rough neutrosophic multisets relations on  $U \times U$ , based on  $X \times Y, Y \times Z$ , respectively. Then  $(\mathfrak{R}_1 \circ \mathfrak{R}_2)^{-1} = \mathfrak{R}_2^{-1} \circ \mathfrak{R}_1^{-1}$ .

**Proof:** For all  $x, y, z \in U$ , we have

$$\begin{aligned} T_{(\mathfrak{R}_1 \circ \mathfrak{R}_2)^{-1}}^i(z, x) &= T_{\mathfrak{R}_1 \circ \mathfrak{R}_2}^i(x, z) \\ &= \max_{y \in U} \{ \min [T_{\mathfrak{R}_1}^i(x, y), T_{\mathfrak{R}_2}^i(y, z)] \} = \max_{y \in U} \{ \min [T_{(\mathfrak{R}_1)^{-1}}^i(y, x), T_{(\mathfrak{R}_2)^{-1}}^i(z, y)] \} \\ &= \max_{y \in U} \{ \min [T_{(\mathfrak{R}_2)^{-1}}^i(z, y), T_{(\mathfrak{R}_1)^{-1}}^i(y, x)] \} \\ &= T_{(\mathfrak{R}_2)^{-1} \circ (\mathfrak{R}_1)^{-1}}^i(z, x); \end{aligned}$$

Similarly, proof for indeterminate function and falsity function.

That means  $(\mathfrak{R}_1 \circ \mathfrak{R}_2)^{-1} = \mathfrak{R}_2^{-1} \circ \mathfrak{R}_1^{-1}$ .

The representation of inverse rough neutrosophic multisets relation  $\mathfrak{R}^{-1}$  can be represented by rough neutrosophic multisets relation  $\mathfrak{R}$  by using a matrix  $M(\mathfrak{R})^t$ , it is the transposition of a matrix  $M(\mathfrak{R})$ .

**Example 3.2.5:** Consider the rough neutrosophic multisets relation  $M(\mathfrak{R})$  in example 3.5;

$$M(\mathfrak{R}) = \begin{bmatrix} (0.3, 0), (1, 1), (1, 1) & (0, 0), (1, 1), (1, 1) & (0.9, 0), (1, 1), (1, 1) \\ (0, 0), (1, 1), (1, 1) & (0, 0), (1, 1), (1, 1) & (0, 0), (1, 1), (1, 1) \\ (0.4, 0), (1, 1), (1, 1) & (0, 0), (1, 1), (1, 1) & (0.9, 0), (1, 1), (1, 1) \end{bmatrix}$$

Then the inverse rough neutrosophic multisets relation  $\mathfrak{R}^{-1}$

$$M(\mathfrak{R}^{-1}) = M(\mathfrak{R})^t = \begin{bmatrix} (0.3, 0), (1, 1), (1, 1) & (0, 0), (1, 1), (1, 1) & (0.4, 0), (1, 1), (1, 1) \\ (0, 0), (1, 1), (1, 1) & (0, 0), (1, 1), (1, 1) & (0, 0), (1, 1), (1, 1) \\ (0.9, 0), (1, 1), (1, 1) & (0, 0), (1, 1), (1, 1) & (0.9, 0), (1, 1), (1, 1) \end{bmatrix}$$

### 3.3 The Reflexive, Symmetric, Transitive Rough Neutrosophic Multisets Relation

In this section, we consider some properties of rough neutrosophic multisets on universe, such as reflexive, symmetric and transitive properties.

Let  $(U, \mathcal{R})$  be a crisp approximation space and  $X$  is a rough neutrosophic multisets on  $(U, \mathcal{R})$ . From here onwards, the rough neutrosophic multisets relation  $\mathfrak{R}$  is called a rough neutrosophic multisets relation on  $(U, \mathcal{R})$  based on the rough neutrosophic multisets  $X$ .

**Definition 3.3.1** The rough neutrosophic multisets relation  $\mathfrak{R}$  is said to be reflexive rough neutrosophic multisets relation if  $T_{\mathfrak{R}}^i(x, x) = 1, I_{\mathfrak{R}}^i(x, x) = F_{\mathfrak{R}}^i(x, x) = 0$  and for all  $(x, x) \in U \times U, i = 1, 2, \dots, p$ .

**Proposition 3.3.2** Let  $\mathfrak{R}_1, \mathfrak{R}_2$  be two rough neutrosophic multisets relation on  $U$  based  $X$ . If  $\mathfrak{R}_1, \mathfrak{R}_2$  are the reflexive rough neutrosophic multisets relations then  $\mathfrak{R}_1 \wedge \mathfrak{R}_2, \mathfrak{R}_1 \vee \mathfrak{R}_2, \mathfrak{R}_1 \otimes \mathfrak{R}_2, \mathfrak{R}_1 \oplus \mathfrak{R}_2$  and  $\mathfrak{R}_1 \circ \mathfrak{R}_2$  is also reflexive.

**Proof:** If  $\mathfrak{R}_1, \mathfrak{R}_2$  are reflexive rough neutrosophic multisets relation, then

$$T_{\mathfrak{R}_1}^i(x, x) = T_{\mathfrak{R}_2}^i(x, x) = 1, I_{\mathfrak{R}_1}^i(x, x) = I_{\mathfrak{R}_2}^i(x, x) = 0 \text{ and } F_{\mathfrak{R}_1}^i(x, x) = F_{\mathfrak{R}_2}^i(x, x) = 0 \text{ for all } (x, x) \in U \times U. \text{ We have}$$

- i)  $T_{\mathfrak{R}_1 \wedge \mathfrak{R}_2}^i(x, x) = \min\{T_{\mathfrak{R}_1}^i(x, x), T_{\mathfrak{R}_2}^i(x, x)\} = 1;$
- $I_{\mathfrak{R}_1 \wedge \mathfrak{R}_2}^i(x, x) = \max\{I_{\mathfrak{R}_1}^i(x, x), I_{\mathfrak{R}_2}^i(x, x)\} = 0;$  and
- $F_{\mathfrak{R}_1 \wedge \mathfrak{R}_2}^i(x, x) = \max\{F_{\mathfrak{R}_1}^i(x, x), F_{\mathfrak{R}_2}^i(x, x)\} = 0$

for all  $(x, x) \in U \times U$  and  $\mathfrak{R}_1 \wedge \mathfrak{R}_2$  is reflexive rough neutrosophic multisets relation.

$$\begin{aligned} \text{ii)} \quad & T_{\mathfrak{R}_1 \vee \mathfrak{R}_2}^i(x, x) = \max\{T_{\mathfrak{R}_1}^i(x, x), T_{\mathfrak{R}_2}^i(x, x)\} = 1; \\ & I_{\mathfrak{R}_1 \vee \mathfrak{R}_2}^i(x, x) = \min\{I_{\mathfrak{R}_1}^i(x, x), I_{\mathfrak{R}_2}^i(x, x)\} = 0; \text{ and} \\ & F_{\mathfrak{R}_1 \vee \mathfrak{R}_2}^i(x, x) = \min\{F_{\mathfrak{R}_1}^i(x, x), F_{\mathfrak{R}_2}^i(x, x)\} = 0 \end{aligned}$$

for all  $(x, x) \in U \times U$  and  $\mathfrak{R}_1 \vee \mathfrak{R}_2$  is reflexive rough neutrosophic multisets relation.

$$\begin{aligned} \text{iii)} \quad & T_{\mathfrak{R}_1 \otimes \mathfrak{R}_2}^i(x, x) = T_{\mathfrak{R}_1}^i(x, x) \cdot T_{\mathfrak{R}_2}^i(x, x) = 1; \\ & I_{\mathfrak{R}_1 \otimes \mathfrak{R}_2}^i(x, x) = I_{\mathfrak{R}_1}^i(x, x) + I_{\mathfrak{R}_2}^i(x, x) - I_{\mathfrak{R}_1}^i(x, x) \cdot I_{\mathfrak{R}_2}^i(x, x) = 0; \text{ and} \\ & F_{\mathfrak{R}_1 \otimes \mathfrak{R}_2}^i(x, x) = F_{\mathfrak{R}_1}^i(x, x) + F_{\mathfrak{R}_2}^i(x, x) - F_{\mathfrak{R}_1}^i(x, x) \cdot F_{\mathfrak{R}_2}^i(x, x) = 0 \end{aligned}$$

for all  $(x, x) \in U \times U$  and  $\mathfrak{R}_1 \otimes \mathfrak{R}_2$  is reflexive rough neutrosophic multisets relation.

$$\begin{aligned} \text{iv)} \quad & T_{\mathfrak{R}_1 \oplus \mathfrak{R}_2}^i(x, x) = T_{\mathfrak{R}_1}^i(x, x) + T_{\mathfrak{R}_2}^i(x, x) - T_{\mathfrak{R}_1}^i(x, x) \cdot T_{\mathfrak{R}_2}^i(x, x) = 1; \\ & I_{\mathfrak{R}_1 \oplus \mathfrak{R}_2}^i(x, x) = I_{\mathfrak{R}_1}^i(x, x) \cdot I_{\mathfrak{R}_2}^i(x, x) = 0; \text{ and} \\ & F_{\mathfrak{R}_1 \oplus \mathfrak{R}_2}^i(x, x) = F_{\mathfrak{R}_1}^i(x, x) \cdot F_{\mathfrak{R}_2}^i(x, x) = 0 \end{aligned}$$

for all  $(x, x) \in U \times U$  and  $\mathfrak{R}_1 \oplus \mathfrak{R}_2$  is reflexive rough neutrosophic multisets relation.

$$\begin{aligned} \text{v)} \quad & T_{\mathfrak{R}_1 \circ \mathfrak{R}_2}^i(x, x) = \max_{y \in U} \{\min[T_{\mathfrak{R}_1}^i(x, y), T_{\mathfrak{R}_2}^i(y, x)]\} \\ & = \max_{y \in U} \{\min[T_{\mathfrak{R}_1}^i(x, x), T_{\mathfrak{R}_2}^i(x, x)]\} = 1; \\ & I_{\mathfrak{R}_1 \circ \mathfrak{R}_2}^i(x, x) = \min_{y \in U} \{\max[I_{\mathfrak{R}_1}^i(x, y), I_{\mathfrak{R}_2}^i(y, x)]\} \\ & = \min_{y \in U} \{\max[I_{\mathfrak{R}_1}^i(x, x), I_{\mathfrak{R}_2}^i(x, x)]\} = 0; \text{ and} \\ & F_{\mathfrak{R}_1 \circ \mathfrak{R}_2}^i(x, x) = \min_{y \in U} \{\max[F_{\mathfrak{R}_1}^i(x, y), F_{\mathfrak{R}_2}^i(y, x)]\} \\ & = \min_{y \in U} \{\max[F_{\mathfrak{R}_1}^i(x, x), F_{\mathfrak{R}_2}^i(x, x)]\} = 0 \end{aligned}$$

for all  $(x, x) \in U \times U, X \equiv Y$  and  $\mathfrak{R}_1 \circ \mathfrak{R}_2$  is reflexive rough neutrosophic multisets relation.

**Definition 3.3.3** The rough neutrosophic multisets relation  $\mathfrak{R}$  is said to be symmetric rough neutrosophic multisets relation if  $T_{\mathfrak{R}}^i(x, y) = T_{\mathfrak{R}}^i(y, x)$ ,  $I_{\mathfrak{R}}^i(x, y) = I_{\mathfrak{R}}^i(y, x)$  and  $F_{\mathfrak{R}}^i(x, y) = F_{\mathfrak{R}}^i(y, x)$  for all  $(x, y) \in U \times U$ ,  $i = 1, 2, \dots, p$ .

We note that if  $\mathfrak{R}$  is a symmetric rough neutrosophic multisets relation then the matrix  $M(\mathfrak{R})$  is a symmetric matrix.

**Proposition 3.3.4** If  $\mathfrak{R}$  is said to be symmetric rough neutrosophic multisets relation, then  $\mathfrak{R}^{-1}$  is also symmetric.

**Proof:** Assume that  $\mathfrak{R}$  is symmetric rough neutrosophic multisets relation, then we have

$$T_{\mathfrak{R}}^i(x, y) = T_{\mathfrak{R}}^i(y, x), I_{\mathfrak{R}}^i(x, y) = I_{\mathfrak{R}}^i(y, x) \text{ and } F_{\mathfrak{R}}^i(x, y) = F_{\mathfrak{R}}^i(y, x).$$

Also, if  $\mathfrak{R}^{-1}$  is an inverse rough neutrosophic multisets relation, then we have

$$T_{\mathfrak{R}^{-1}}^i(x, y) = T_{\mathfrak{R}}^i(y, x), I_{\mathfrak{R}^{-1}}^i(x, y) = I_{\mathfrak{R}}^i(y, x) \text{ and } F_{\mathfrak{R}^{-1}}^i(x, y) = F_{\mathfrak{R}}^i(y, x) \text{ for all } (x, y) \in U \times U.$$

To prove  $\mathfrak{R}^{-1}$  is symmetric, we must prove that

$$T_{\mathfrak{R}^{-1}}^i(x, y) = T_{\mathfrak{R}^{-1}}^i(y, x), I_{\mathfrak{R}^{-1}}^i(x, y) = I_{\mathfrak{R}^{-1}}^i(y, x) \text{ and } F_{\mathfrak{R}^{-1}}^i(x, y) = F_{\mathfrak{R}^{-1}}^i(y, x) \text{ for all } (x, y) \in U \times U.$$

Therefore,

$$\begin{aligned} & T_{\mathfrak{R}^{-1}}^i(x, y) = T_{\mathfrak{R}}^i(y, x) = T_{\mathfrak{R}}^i(x, y) = T_{\mathfrak{R}^{-1}}^i(y, x); \\ & I_{\mathfrak{R}^{-1}}^i(x, y) = I_{\mathfrak{R}}^i(y, x) = I_{\mathfrak{R}}^i(x, y) = I_{\mathfrak{R}^{-1}}^i(y, x); \text{ and} \\ & F_{\mathfrak{R}^{-1}}^i(x, y) = F_{\mathfrak{R}}^i(y, x) = F_{\mathfrak{R}}^i(x, y) = F_{\mathfrak{R}^{-1}}^i(y, x) \end{aligned}$$

for all  $(x, y) \in U \times U$  and  $\mathfrak{R}$  is said to be symmetric rough neutrosophic multisets relation, then  $\mathfrak{R}^{-1}$  is also symmetric rough neutrosophic multisets relation.

**Proposition 3.3.5** *Let  $\mathfrak{R}_1, \mathfrak{R}_2$  be two rough neutrosophic multisets relations on  $U$  based rough neutrosophic multisets. If  $\mathfrak{R}_1, \mathfrak{R}_2$  are the symmetric rough neutrosophic multisets relations then  $\mathfrak{R}_1 \wedge \mathfrak{R}_2, \mathfrak{R}_1 \vee \mathfrak{R}_2, \mathfrak{R}_1 \otimes \mathfrak{R}_2$  and  $\mathfrak{R}_1 \oplus \mathfrak{R}_2$  also symmetric.*

**Proof:** Since  $\mathfrak{R}_1$  is symmetric, then we have;

$$T_{\mathfrak{R}_1}^i(x, y) = T_{\mathfrak{R}_1}^i(y, x), I_{\mathfrak{R}_1}^i(x, y) = I_{\mathfrak{R}_1}^i(y, x) \text{ and } F_{\mathfrak{R}_1}^i(x, y) = F_{\mathfrak{R}_1}^i(y, x)$$

Similarly,  $\mathfrak{R}_2$  is symmetric, then we have;

$$T_{\mathfrak{R}_2}^i(x, y) = T_{\mathfrak{R}_2}^i(y, x), I_{\mathfrak{R}_2}^i(x, y) = I_{\mathfrak{R}_2}^i(y, x) \text{ and } F_{\mathfrak{R}_2}^i(x, y) = F_{\mathfrak{R}_2}^i(y, x)$$

Therefore;

$$\begin{aligned} \text{i) } T_{\mathfrak{R}_1 \wedge \mathfrak{R}_2}^i(x, y) &= \min\{T_{\mathfrak{R}_1}^i(x, y), T_{\mathfrak{R}_2}^i(x, y)\} \\ &= \min\{T_{\mathfrak{R}_1}^i(y, x), T_{\mathfrak{R}_2}^i(y, x)\} = T_{\mathfrak{R}_1 \wedge \mathfrak{R}_2}^i(y, x); \\ I_{\mathfrak{R}_1 \wedge \mathfrak{R}_2}^i(x, y) &= \max\{I_{\mathfrak{R}_1}^i(x, y), I_{\mathfrak{R}_2}^i(x, y)\} \\ &= \max\{I_{\mathfrak{R}_1}^i(y, x), I_{\mathfrak{R}_2}^i(y, x)\} = I_{\mathfrak{R}_1 \wedge \mathfrak{R}_2}^i(y, x); \text{ and} \\ F_{\mathfrak{R}_1 \wedge \mathfrak{R}_2}^i(x, y) &= \max\{F_{\mathfrak{R}_1}^i(x, y), F_{\mathfrak{R}_2}^i(x, y)\} \\ &= \max\{F_{\mathfrak{R}_1}^i(y, x), F_{\mathfrak{R}_2}^i(y, x)\} = F_{\mathfrak{R}_1 \wedge \mathfrak{R}_2}^i(y, x) \end{aligned}$$

for all  $(x, y) \in U \times U$  and  $\mathfrak{R}_1 \wedge \mathfrak{R}_2$  is symmetric rough neutrosophic multisets relation.

$$\begin{aligned} \text{ii) } T_{\mathfrak{R}_1 \vee \mathfrak{R}_2}^i(x, y) &= \max\{T_{\mathfrak{R}_1}^i(x, y), T_{\mathfrak{R}_2}^i(x, y)\} \\ &= \max\{T_{\mathfrak{R}_1}^i(y, x), T_{\mathfrak{R}_2}^i(y, x)\} = T_{\mathfrak{R}_1 \vee \mathfrak{R}_2}^i(y, x); \\ I_{\mathfrak{R}_1 \vee \mathfrak{R}_2}^i(x, y) &= \min\{I_{\mathfrak{R}_1}^i(x, y), I_{\mathfrak{R}_2}^i(x, y)\} \\ &= \min\{I_{\mathfrak{R}_1}^i(y, x), I_{\mathfrak{R}_2}^i(y, x)\} = I_{\mathfrak{R}_1 \vee \mathfrak{R}_2}^i(y, x); \text{ and} \\ F_{\mathfrak{R}_1 \vee \mathfrak{R}_2}^i(x, y) &= \min\{F_{\mathfrak{R}_1}^i(x, y), F_{\mathfrak{R}_2}^i(x, y)\} \\ &= \min\{F_{\mathfrak{R}_1}^i(y, x), F_{\mathfrak{R}_2}^i(y, x)\} = F_{\mathfrak{R}_1 \vee \mathfrak{R}_2}^i(y, x) \end{aligned}$$

for all  $(x, y) \in U \times U$  and  $\mathfrak{R}_1 \vee \mathfrak{R}_2$  is symmetric rough neutrosophic multisets relation.

$$\begin{aligned} \text{iii) } T_{\mathfrak{R}_1 \otimes \mathfrak{R}_2}^i(x, y) &= T_{\mathfrak{R}_1}^i(x, y) \cdot T_{\mathfrak{R}_2}^i(x, y) = T_{\mathfrak{R}_1}^i(y, x) \cdot T_{\mathfrak{R}_2}^i(y, x) = T_{\mathfrak{R}_1 \otimes \mathfrak{R}_2}^i(y, x); \\ I_{\mathfrak{R}_1 \otimes \mathfrak{R}_2}^i(x, y) &= I_{\mathfrak{R}_1}^i(x, y) + I_{\mathfrak{R}_2}^i(x, y) - I_{\mathfrak{R}_1}^i(x, y) \cdot I_{\mathfrak{R}_2}^i(x, y) \\ &= I_{\mathfrak{R}_1}^i(y, x) + I_{\mathfrak{R}_2}^i(y, x) - I_{\mathfrak{R}_1}^i(y, x) \cdot I_{\mathfrak{R}_2}^i(y, x) \\ &= I_{\mathfrak{R}_1 \otimes \mathfrak{R}_2}^i(y, x); \text{ and} \\ F_{\mathfrak{R}_1 \otimes \mathfrak{R}_2}^i(x, y) &= F_{\mathfrak{R}_1}^i(x, y) + F_{\mathfrak{R}_2}^i(x, y) - F_{\mathfrak{R}_1}^i(x, y) \cdot F_{\mathfrak{R}_2}^i(x, y) \\ &= F_{\mathfrak{R}_1}^i(y, x) + F_{\mathfrak{R}_2}^i(y, x) - F_{\mathfrak{R}_1}^i(y, x) \cdot F_{\mathfrak{R}_2}^i(y, x) \\ &= F_{\mathfrak{R}_1 \otimes \mathfrak{R}_2}^i(y, x) \end{aligned}$$

for all  $(x, y) \in U \times U$  and  $\mathfrak{R}_1 \otimes \mathfrak{R}_2$  is symmetric rough neutrosophic multisets relation.

$$\begin{aligned} \text{iv) } T_{\mathfrak{R}_1 \oplus \mathfrak{R}_2}^i(x, y) &= T_{\mathfrak{R}_1}^i(x, y) + T_{\mathfrak{R}_2}^i(x, y) - T_{\mathfrak{R}_1}^i(x, y) \cdot T_{\mathfrak{R}_2}^i(x, y) \\ &= T_{\mathfrak{R}_1}^i(y, x) + T_{\mathfrak{R}_2}^i(y, x) - T_{\mathfrak{R}_1}^i(y, x) \cdot T_{\mathfrak{R}_2}^i(y, x) = T_{\mathfrak{R}_1 \oplus \mathfrak{R}_2}^i(y, x); \\ I_{\mathfrak{R}_1 \oplus \mathfrak{R}_2}^i(x, y) &= I_{\mathfrak{R}_1}^i(x, y) \cdot I_{\mathfrak{R}_2}^i(x, y) = I_{\mathfrak{R}_1}^i(y, x) \cdot I_{\mathfrak{R}_2}^i(y, x) = I_{\mathfrak{R}_1 \oplus \mathfrak{R}_2}^i(y, x); \text{ and} \\ F_{\mathfrak{R}_1 \oplus \mathfrak{R}_2}^i(x, y) &= F_{\mathfrak{R}_1}^i(x, y) \cdot F_{\mathfrak{R}_2}^i(x, y) = F_{\mathfrak{R}_1}^i(y, x) \cdot F_{\mathfrak{R}_2}^i(y, x) = F_{\mathfrak{R}_1 \oplus \mathfrak{R}_2}^i(y, x) \end{aligned}$$

for all  $(x, y) \in U \times U$  and  $\mathfrak{R}_1 \oplus \mathfrak{R}_2$  is symmetric rough neutrosophic multisets relation.



**Remark 3.3.6:**  $\mathfrak{R}_1 \circ \mathfrak{R}_2$  in general is not symmetric, as

$$\begin{aligned} T_{\mathfrak{R}_1 \circ \mathfrak{R}_2}^i(x, z) &= \max_{y \in U} \{ \min [ T_{\mathfrak{R}_1}^i(x, y), T_{\mathfrak{R}_2}^i(y, z) ] \} \\ &= \max_{y \in U} \{ \min [ T_{\mathfrak{R}_1}^i(y, x), T_{\mathfrak{R}_2}^i(z, x) ] \} \neq T_{\mathfrak{R}_1 \circ \mathfrak{R}_2}^i(z, x) \end{aligned}$$

The proof is similarly for indeterminate function and falsity function.

But,  $\mathfrak{R}_1 \circ \mathfrak{R}_2$  is symmetric if  $\mathfrak{R}_1 \circ \mathfrak{R}_2 = \mathfrak{R}_2 \circ \mathfrak{R}_1$ , for  $\mathfrak{R}_1$  and  $\mathfrak{R}_2$  are symmetric relations.

$$\begin{aligned} T_{\mathfrak{R}_1 \circ \mathfrak{R}_2}^i(x, z) &= \max_{y \in U} \{ \min [ T_{\mathfrak{R}_1}^i(x, y), T_{\mathfrak{R}_2}^i(y, z) ] \} \\ &= \max_{y \in U} \{ \min [ T_{\mathfrak{R}_1}^i(y, x), T_{\mathfrak{R}_2}^i(z, y) ] \} = \max_{y \in U} \{ \min [ T_{\mathfrak{R}_2}^i(y, x), T_{\mathfrak{R}_2}^i(z, y) ] \} \\ &= \max_{y \in U} \{ \min [ T_{\mathfrak{R}_2}^i(z, y), T_{\mathfrak{R}_2}^i(y, x) ] \} = \max_{y \in U} \{ \min [ T_{\mathfrak{R}_1}^i(z, y), T_{\mathfrak{R}_1}^i(y, x) ] \} \\ &= T_{\mathfrak{R}_1 \circ \mathfrak{R}_2}^i(z, x) \end{aligned}$$

for all  $(x, z) \in U \times U$  and  $y \in U$ .

The proof is similarly for indeterminate function and falsity function.

**Definition 3.3.7** The rough neutrosophic multisets relation  $\mathfrak{R}$  is said to be transitive rough neutrosophic multisets relation if  $\mathfrak{R} \circ \mathfrak{R} \subseteq \mathfrak{R}$  such that  $T_{\mathfrak{R}}^i(y, x) \geq T_{\mathfrak{R} \circ \mathfrak{R}}^i(y, x)$ ,  $I_{\mathfrak{R}}^i(y, x) \leq I_{\mathfrak{R} \circ \mathfrak{R}}^i(y, x)$  and  $F_{\mathfrak{R}}^i(y, x) \leq F_{\mathfrak{R} \circ \mathfrak{R}}^i(y, x)$  for all  $x, y \in U$ .

**Definition 3.3.8** The rough neutrosophic multisets relation  $\mathfrak{R}$  on  $U$  based on the neutrosophic multisets  $X$  is called a rough neutrosophic multisets equivalence relation if it is reflexive, symmetric and transitive rough neutrosophic multisets relation.

**Proposition 3.3.9** If  $\mathfrak{R}$  is transitive rough neutrosophic multisets relation, then  $\mathfrak{R}^{-1}$  is also transitive.

**Proof:**  $\mathfrak{R}$  is transitive rough neutrosophic multisets relation if  $\mathfrak{R} \circ \mathfrak{R} \subseteq \mathfrak{R}$ , hence if  $\mathfrak{R}^{-1} \circ \mathfrak{R}^{-1} \subseteq \mathfrak{R}^{-1}$ , then  $\mathfrak{R}^{-1}$  is transitive.

Consider;

$$\begin{aligned} T_{\mathfrak{R}^{-1}}^i(x, y) &= T_{\mathfrak{R}}^i(y, x) \geq T_{\mathfrak{R} \circ \mathfrak{R}}^i(y, x) \\ &= \max_{z \in U} \{ \min [ T_{\mathfrak{R}}^i(y, z), T_{\mathfrak{R}}^i(z, x) ] \} \\ &= \max_{z \in U} \{ \min [ T_{\mathfrak{R}^{-1}}^i(z, y), T_{\mathfrak{R}^{-1}}^i(x, z) ] \} = \max_{z \in U} \{ \min [ T_{\mathfrak{R}^{-1}}^i(x, z), T_{\mathfrak{R}^{-1}}^i(z, y) ] \} \\ &= T_{\mathfrak{R}^{-1} \circ \mathfrak{R}^{-1}}^i(x, y); \end{aligned}$$

The proof is similarly for indeterminate function and falsity function.

Hence, the proof is valid.

**Proposition 3.3.10** Let  $\mathfrak{R}_1, \mathfrak{R}_2$  be two rough neutrosophic multisets relations on  $U$  based rough neutrosophic multisets. If  $\mathfrak{R}_1$  are the transitive rough neutrosophic multisets relation, then  $\mathfrak{R}_1 \wedge \mathfrak{R}_2$  is also transitive.

**Proof:** As  $\mathfrak{R}_1$  and  $\mathfrak{R}_2$  are transitive rough neutrosophic multisets relation,  $\mathfrak{R}_1 \circ \mathfrak{R}_1 \subseteq \mathfrak{R}_1$  and  $\mathfrak{R}_2 \circ \mathfrak{R}_2 \subseteq \mathfrak{R}_2$ . Also

$$\begin{aligned} T_{\mathfrak{R}_1 \wedge \mathfrak{R}_2}^i(x, y) &\geq T_{(\mathfrak{R}_1 \wedge \mathfrak{R}_2) \circ (\mathfrak{R}_1 \wedge \mathfrak{R}_2)}^i(x, y); \\ I_{\mathfrak{R}_1 \wedge \mathfrak{R}_2}^i(x, y) &\leq I_{(\mathfrak{R}_1 \wedge \mathfrak{R}_2) \circ (\mathfrak{R}_1 \wedge \mathfrak{R}_2)}^i(x, y); \text{ and} \\ F_{\mathfrak{R}_1 \wedge \mathfrak{R}_2}^i(x, y) &\leq F_{(\mathfrak{R}_1 \wedge \mathfrak{R}_2) \circ (\mathfrak{R}_1 \wedge \mathfrak{R}_2)}^i(x, y) \end{aligned}$$

implies that  $(\mathfrak{R}_1 \wedge \mathfrak{R}_2) \circ (\mathfrak{R}_1 \wedge \mathfrak{R}_2) \subseteq \mathfrak{R}_1 \wedge \mathfrak{R}_2$ , hence  $\mathfrak{R}_1 \wedge \mathfrak{R}_2$  is transitive.

**Proposition 3.3.11** *If  $\mathfrak{R}_1$  and  $\mathfrak{R}_2$  are transitive rough neutrosophic multisets relations, then  $\mathfrak{R}_1 \vee \mathfrak{R}_2$ ,  $\mathfrak{R}_1 \otimes \mathfrak{R}_2$  and  $\mathfrak{R}_1 \oplus \mathfrak{R}_2$  are not transitive.*

**Proof:**

i) As

$$T_{\mathfrak{R}_1 \vee \mathfrak{R}_2}^i(x, y) = \max\{T_{\mathfrak{R}_1}^i(x, y), T_{\mathfrak{R}_2}^i(x, y)\},$$

$$I_{\mathfrak{R}_1 \vee \mathfrak{R}_2}^i(x, y) = \min\{I_{\mathfrak{R}_1}^i(x, y), I_{\mathfrak{R}_2}^i(x, y)\}, \text{ and}$$

$$F_{\mathfrak{R}_1 \vee \mathfrak{R}_2}^i(x, y) = \min\{F_{\mathfrak{R}_1}^i(x, y), F_{\mathfrak{R}_2}^i(x, y)\}$$

and,

$$T_{\mathfrak{R}_1 \vee \mathfrak{R}_2}^i(x, y) \leq T_{(\mathfrak{R}_1 \vee \mathfrak{R}_2) \circ (\mathfrak{R}_1 \vee \mathfrak{R}_2)}^i(x, y);$$

$$I_{\mathfrak{R}_1 \vee \mathfrak{R}_2}^i(x, y) \geq I_{(\mathfrak{R}_1 \vee \mathfrak{R}_2) \circ (\mathfrak{R}_1 \vee \mathfrak{R}_2)}^i(x, y); \text{ and}$$

$$F_{\mathfrak{R}_1 \vee \mathfrak{R}_2}^i(x, y) \geq F_{(\mathfrak{R}_1 \vee \mathfrak{R}_2) \circ (\mathfrak{R}_1 \vee \mathfrak{R}_2)}^i(x, y)$$

ii) As

$$T_{\mathfrak{R}_1 \otimes \mathfrak{R}_2}^i(x, y) = T_{\mathfrak{R}_1}^i(x, y) \cdot T_{\mathfrak{R}_2}^i(x, y),$$

$$I_{\mathfrak{R}_1 \otimes \mathfrak{R}_2}^i(x, y) = I_{\mathfrak{R}_1}^i(x, y) + I_{\mathfrak{R}_2}^i(x, y) - I_{\mathfrak{R}_1}^i(x, y) \cdot I_{\mathfrak{R}_2}^i(x, y), \text{ and}$$

$$F_{\mathfrak{R}_1 \otimes \mathfrak{R}_2}^i(x, y) = F_{\mathfrak{R}_1}^i(x, y) + F_{\mathfrak{R}_2}^i(x, y) - F_{\mathfrak{R}_1}^i(x, y) \cdot F_{\mathfrak{R}_2}^i(x, y)$$

and,

$$T_{\mathfrak{R}_1 \otimes \mathfrak{R}_2}^i(x, y) \leq T_{(\mathfrak{R}_1 \otimes \mathfrak{R}_2) \circ (\mathfrak{R}_1 \otimes \mathfrak{R}_2)}^i(x, y);$$

$$I_{\mathfrak{R}_1 \otimes \mathfrak{R}_2}^i(x, y) \geq I_{(\mathfrak{R}_1 \otimes \mathfrak{R}_2) \circ (\mathfrak{R}_1 \otimes \mathfrak{R}_2)}^i(x, y); \text{ and } F_{\mathfrak{R}_1 \otimes \mathfrak{R}_2}^i(x, y) \geq F_{(\mathfrak{R}_1 \otimes \mathfrak{R}_2) \circ (\mathfrak{R}_1 \otimes \mathfrak{R}_2)}^i(x, y)$$

(iii) As

$$T_{\mathfrak{R}_1 \oplus \mathfrak{R}_2}^i(x, y) = T_{\mathfrak{R}_1}^i(x, y) + T_{\mathfrak{R}_2}^i(x, y) - T_{\mathfrak{R}_1}^i(x, y) \cdot T_{\mathfrak{R}_2}^i(x, y),$$

$$I_{\mathfrak{R}_1 \oplus \mathfrak{R}_2}^i(x, y) = I_{\mathfrak{R}_1}^i(x, y) \cdot I_{\mathfrak{R}_2}^i(x, y), \text{ and}$$

$$F_{\mathfrak{R}_1 \oplus \mathfrak{R}_2}^i(x, y) = F_{\mathfrak{R}_1}^i(x, y) \cdot F_{\mathfrak{R}_2}^i(x, y)$$

and

$$T_{\mathfrak{R}_1 \oplus \mathfrak{R}_2}^i(x, y) \leq T_{(\mathfrak{R}_1 \oplus \mathfrak{R}_2) \circ (\mathfrak{R}_1 \oplus \mathfrak{R}_2)}^i(x, y);$$

$$I_{\mathfrak{R}_1 \oplus \mathfrak{R}_2}^i(x, y) \geq I_{(\mathfrak{R}_1 \oplus \mathfrak{R}_2) \circ (\mathfrak{R}_1 \oplus \mathfrak{R}_2)}^i(x, y); \text{ and } F_{\mathfrak{R}_1 \oplus \mathfrak{R}_2}^i(x, y) \geq F_{(\mathfrak{R}_1 \oplus \mathfrak{R}_2) \circ (\mathfrak{R}_1 \oplus \mathfrak{R}_2)}^i(x, y)$$

Hence,  $\mathfrak{R}_1 \vee \mathfrak{R}_2$ ,  $\mathfrak{R}_1 \otimes \mathfrak{R}_2$  and  $\mathfrak{R}_1 \oplus \mathfrak{R}_2$  are not transitive.

#### 4 An application to marketing strategy

The aims of multi criteria decision making (MCDM) are to solve the problem involving multi decision by many expert opinions and many alternatives given and MCDM also try to get the best alternative solution based on the multi criteria evaluate by many experts. The study of MCDM with the neutrosophic environment is well established in [38]–[44].

This section gives a situation of solving a real application of the rough neutrosophic multisets relation in marketing strategy.

Assume  $J = \{j_1, j_2, j_3\}$  denotes for three jeans showed available to be purchased in a shop G. Let  $\mathcal{R}_j$  be a relation defined on the  $J$  as  $a\mathcal{R}_j b$  if and only if  $a, b$  coming from the same continent about quality of the jeans.  $a\mathcal{R}_j b$  is composed by  $\mathcal{R}_j = \{j_1, j_2, j_3\}$ . The relation  $\mathcal{R}_j$  is explains the effect of the quality of jeans in shop Z. We now try to get the opinion from two independent customers about the quality of jeans considering whether the jeans are comprised of "good texture", a level of indeterminacy with respect to the customers which is "no comment" and whether they feel that the jean is comprised of "a not all that great texture". In the customers' opinion, rough neutrosophic multisets,  $A$  and  $B$  can be defined as follows:

$$A = \{ \langle j_1, (0.9, 0.2), (0.3, 0.6), (0.5, 0.7) \rangle, \\ \langle j_2, (0.4, 0.6), (0.2, 0.4), (0.5, 0.6) \rangle, \}$$

$$\langle j_3, (1.0, 0.6), (0.4, 0.5), (0.6, 0.7) \rangle \text{ and}$$

$$B = \{ \langle j_1, (0.5, 0.7), (0.4, 0.6), (0.2, 0.8) \rangle, \\ \langle j_2, (0.6, 0.7), (0.2, 0.8), (0.4, 0.5) \rangle, \\ \langle j_3, (1.0, 0.8), (0.3, 0.6), (0.2, 0.8) \rangle \}$$

By satisfied all the condition in definition 3.3, we will define the relation of rough neutrosophic multisets  $\mathfrak{R}$  on qualities of jeans  $J \times J$  based on customers opinion  $A \times B$  as follows:

Step 1: Compute lower and upper approximation values for rough neutrosophic multisets.

$$\underline{\mathcal{R}}_J(A) = \{ \langle j_1, (0.4, 0.2), (0.4, 0.6), (0.6, 0.7) \rangle, \\ \langle j_2, (0.4, 0.2), (0.4, 0.6), (0.6, 0.7) \rangle, \\ \langle j_3, (0.4, 0.2), (0.4, 0.6), (0.6, 0.7) \rangle \}$$

$$\underline{\mathcal{R}}_J(B) = \{ \langle j_1, (0.5, 0.7), (0.4, 0.8), (0.4, 0.8) \rangle, \\ \langle j_2, (0.5, 0.7), (0.4, 0.8), (0.4, 0.8) \rangle, \\ \langle j_3, (0.5, 0.7), (0.4, 0.8), (0.4, 0.8) \rangle \}$$

$$\overline{\mathcal{R}}_J(A) = \{ \langle j_1, (1.0, 0.6), (0.2, 0.4), (0.5, 0.6) \rangle, \\ \langle j_2, (1.0, 0.6), (0.2, 0.4), (0.5, 0.6) \rangle, \\ \langle j_3, (1.0, 0.6), (0.2, 0.4), (0.5, 0.6) \rangle \}$$

$$\overline{\mathcal{R}}_J(B) = \{ \langle j_1, (1.0, 0.8), (0.2, 0.6), (0.2, 0.5) \rangle, \\ \langle j_2, (1.0, 0.8), (0.2, 0.6), (0.2, 0.5) \rangle, \\ \langle j_3, (1.0, 0.8), (0.2, 0.6), (0.2, 0.5) \rangle \}$$

Step 2: Construct the relation of  $\underline{A \times B} = \underline{\mathcal{R}}_J(A) \times \underline{\mathcal{R}}_J(B)$ , relation of  $\overline{A \times B} = \overline{\mathcal{R}}_J(A) \times \overline{\mathcal{R}}_J(B)$ , and relation of  $J \times J$ . All the relation was represented in the Table 1, Table 2 and Table 3, respectively.

$A \times B$	$j_1$	$j_2$	$j_3$
$j_1$	(0.4, 0.2), (0.4, 0.8), (0.6, 0.8)	(0.4, 0.2), (0.4, 0.8), (0.6, 0.8)	(0.4, 0.2), (0.4, 0.8), (0.6, 0.8)
$j_2$	(0.4, 0.2), (0.4, 0.8), (0.6, 0.8)	(0.4, 0.2), (0.4, 0.8), (0.6, 0.8)	(0.4, 0.2), (0.4, 0.8), (0.6, 0.8)
$j_3$	(0.4, 0.2), (0.4, 0.8), (0.6, 0.8)	(0.4, 0.2), (0.4, 0.8), (0.6, 0.8)	(0.4, 0.2), (0.4, 0.8), (0.6, 0.8)

Table 1: Relation of  $A \times B$

$\overline{A \times B}$	$j_1$	$j_2$	$j_3$
$j_1$	(1.0, 0.6), (0.4, 0.6), (0.5, 0.6)	(1.0, 0.6), (0.4, 0.6), (0.5, 0.6)	(1.0, 0.6), (0.4, 0.6), (0.5, 0.6)
$j_2$	(1.0, 0.6), (0.4, 0.6), (0.5, 0.6)	(1.0, 0.6), (0.4, 0.6), (0.5, 0.6)	(1.0, 0.6), (0.4, 0.6), (0.5, 0.6)
$j_3$	(1.0, 0.6), (0.4, 0.6), (0.5, 0.6)	(1.0, 0.6), (0.4, 0.6), (0.5, 0.6)	(1.0, 0.6), (0.4, 0.6), (0.5, 0.6)

Table 2: Relation of  $\overline{A \times B}$

Note that  $T_{\mathfrak{R}}^i(a, b) = 1$ ,  $I_{\mathfrak{R}}^i(a, b) = 0$  and  $F_{\mathfrak{R}}^i(a, b) = 0$  for all  $(a, b) \in \underline{A \times B}$ . Therefore, the relation of  $J \times J$  is

$J \times J$	$j_1$	$j_2$	$j_3$
$j_1$	(1.0, 1.0),	(1.0, 1.0),	(1.0, 1.0),
	(0.0, 0.0),	(0.0, 0.0),	(0.0, 0.0),
	(0.0, 0.0)	(0.0, 0.0)	(0.0, 0.0)
$j_2$	(1.0, 1.0),	(1.0, 1.0),	(1.0, 1.0),
	(0.0, 0.0),	(0.0, 0.0),	(0.0, 0.0),
	(0.0, 0.0)	(0.0, 0.0)	(0.0, 0.0)
$j_3$	(1.0, 1.0),	(1.0, 1.0),	(1.0, 1.0),
	(0.0, 0.0),	(0.0, 0.0),	(0.0, 0.0),
	(0.0, 0.0)	(0.0, 0.0)	(0.0, 0.0)

**Table 3:** Relation of  $J \times J$

*Step 3:* Construct a rough neutrosophic multisets relation  $\mathfrak{R}$ . Note that,  $T_{\mathfrak{R}}^i(a, b) = 0$ ,  $I_{\mathfrak{R}}^i(a, b) = 1$  and  $F_{\mathfrak{R}}^i(a, b) = 1$  for all  $(a, b) \in J \times J - \overline{A \times B}$ . Table 4 represent the rough neutrosophic multisets relation  $\mathfrak{R}$ .

$\mathfrak{R}$	$j_1$	$j_2$	$j_3$
$j_1$	( <b>t<sub>1</sub></b> , 0.0),	( <b>t<sub>2</sub></b> , 0.0),	( <b>t<sub>3</sub></b> , 0.0),
	(1.0, 1.0),	(1.0, 1.0),	(1.0, 1.0),
	(1.0, 1.0)	(1.0, 1.0)	(1.0, 1.0)
$j_2$	( <b>t<sub>4</sub></b> , 0.0),	( <b>t<sub>5</sub></b> , 0.0),	( <b>t<sub>6</sub></b> , 0.0),
	(1.0, 1.0),	(1.0, 1.0),	(1.0, 1.0),
	(1.0, 1.0)	(1.0, 1.0)	(1.0, 1.0)
$j_3$	( <b>t<sub>7</sub></b> , 0.0),	( <b>t<sub>8</sub></b> , 0.0),	( <b>t<sub>9</sub></b> , 0.0),
	(1.0, 1.0),	(1.0, 1.0),	(1.0, 1.0),
	(1.0, 1.0)	(1.0, 1.0)	(1.0, 1.0)

**Table 4:** Rough neutrosophic multi relation  $\mathfrak{R}$ .

*Step 4:* Compute the values for  $t_1$  until  $t_9$  in Table 4.

Note that  $t_1, t_2, \dots, t_9 \in [0, 1]$  and  $0 < T_{\mathfrak{R}}^i(a, b) < 1$ , for all  $(a, b) \in \overline{A \times B} - \underline{A \times B}$  and neutrosophic multi relation of  $T_{\mathfrak{R}}^i(a, b) \leq T_{\overline{A \times B}}^i(a, b) \forall (a, b) \in J \times J$ .

- (i)  $t_1 = T_{\mathfrak{R}}^1(j_1, j_1) = T_{\overline{A \times B}}^1(j_1, j_1) - T_{\underline{A \times B}}^1(j_1, j_1) = 1 - 0.4 = 0.6$ ,  $T_{\mathfrak{R}}^1(j_1, j_1) \leq T_{\overline{A \times B}}^1(j_1, j_1)$  where  $0.6 \leq 1$ . Therefore, the possible values of  $t_1$  is 0.9, 0.8, 0.7 and 0.6.
- (ii)  $t_2 = T_{\mathfrak{R}}^1(j_1, j_2) = T_{\overline{A \times B}}^1(j_1, j_2) - T_{\underline{A \times B}}^1(j_1, j_2) = 1 - 0.4 = 0.6$ ,  $T_{\mathfrak{R}}^1(j_1, j_2) \leq T_{\overline{A \times B}}^1(j_1, j_2)$  where  $0.6 \leq 1$ . Therefore, the possible values of  $t_2$  is 0.9, 0.8, 0.7 and 0.6.
- (iii) The same calculation was used for  $t_3$  until  $t_9$ . Therefore, the possible values for  $t_1$  until  $t_9$  is represent in Table 5.

$t_n, n = 1, 2, \dots, 9$	Possible values	$t_n, n = 1, 2, \dots, 9$	Possible values
$t_1$	0.6, 0.7, 0.8, 0.9	$t_6$	0.6, 0.7, 0.8, 0.9
$t_2$	0.6, 0.7, 0.8, 0.9	$t_7$	0.6, 0.7, 0.8, 0.9
$t_3$	0.6, 0.7, 0.8, 0.9	$t_8$	0.6, 0.7, 0.8, 0.9
$t_4$	0.6, 0.7, 0.8, 0.9	$t_9$	0.6, 0.7, 0.8, 0.9
$t_5$	0.6, 0.7, 0.8, 0.9		

**Table 5:** Possible values for  $t_1$  until  $t_9$

*Step 5:* We defined  $\mathfrak{R} \subseteq J \times J$  as a rough neutrosophic multisets relation on  $J \times J$  based on the  $A \times B$  by a matrix form. We can have different values for  $t_1$  until  $t_9$  as it is true for all possible values in Table 5. We try to get some pattern of the rough neutrosophic multisets relation matrix of our study by three possible cases.

Case 1:  $(j_1, j_n) > (j_2, j_n) > (j_3, j_n)$  for all  $n$ , and unknown value. Therefore, there are two rough neutrosophic multisets relation matrix resulted for this case, represented as  $M(\mathfrak{R}_1)$  and  $M(\mathfrak{R}_2)$ , respectively.

$$M(\mathfrak{R}_1) = \begin{bmatrix} (0.9, 0), (1, 1), (1, 1) & (0.9, 0), (1, 1), (1, 1) & (0.9, 0), (1, 1), (1, 1) \\ (0.8, 0), (1, 1), (1, 1) & (0.8, 0), (1, 1), (1, 1) & (0.8, 0), (1, 1), (1, 1) \\ (0.7, 0), (1, 1), (1, 1) & (0.7, 0), (1, 1), (1, 1) & (0.7, 0), (1, 1), (1, 1) \end{bmatrix}$$

$$M(\mathfrak{R}_2) = \begin{bmatrix} (0.8, 0), (1, 1), (1, 1) & (0.8, 0), (1, 1), (1, 1) & (0.8, 0), (1, 1), (1, 1) \\ (0.7, 0), (1, 1), (1, 1) & (0.7, 0), (1, 1), (1, 1) & (0.7, 0), (1, 1), (1, 1) \\ (0.6, 0), (1, 1), (1, 1) & (0.6, 0), (1, 1), (1, 1) & (0.6, 0), (1, 1), (1, 1) \end{bmatrix}$$

Case 2:  $(j_1, j_n) < (j_2, j_n) < (j_3, j_n)$  for all  $n$ , and unknown value. Therefore, there are two rough neutrosophic multisets relation matrix resulted for this case, represented as  $M(\mathfrak{R}_3)$  and  $M(\mathfrak{R}_4)$ , respectively.

$$M(\mathfrak{R}_3) = \begin{bmatrix} (0.7, 0), (1, 1), (1, 1) & (0.7, 0), (1, 1), (1, 1) & (0.7, 0), (1, 1), (1, 1) \\ (0.8, 0), (1, 1), (1, 1) & (0.8, 0), (1, 1), (1, 1) & (0.8, 0), (1, 1), (1, 1) \\ (0.9, 0), (1, 1), (1, 1) & (0.9, 0), (1, 1), (1, 1) & (0.9, 0), (1, 1), (1, 1) \end{bmatrix}$$

$$M(\mathfrak{R}_4) = \begin{bmatrix} (0.6, 0), (1, 1), (1, 1) & (0.6, 0), (1, 1), (1, 1) & (0.6, 0), (1, 1), (1, 1) \\ (0.7, 0), (1, 1), (1, 1) & (0.7, 0), (1, 1), (1, 1) & (0.7, 0), (1, 1), (1, 1) \\ (0.8, 0), (1, 1), (1, 1) & (0.8, 0), (1, 1), (1, 1) & (0.8, 0), (1, 1), (1, 1) \end{bmatrix}$$

Case 3:  $(j_1, j_n) = (j_2, j_n) = (j_3, j_n)$  for all  $n$ , and unknown value. Therefore the rough neutrosophic multisets relation matrix resulted as  $M(\mathfrak{R}_5)$ .

$$M(\mathfrak{R}_5) = \begin{bmatrix} (0.8, 0), (1, 1), (1, 1) & (0.8, 0), (1, 1), (1, 1) & (0.8, 0), (1, 1), (1, 1) \\ (0.8, 0), (1, 1), (1, 1) & (0.8, 0), (1, 1), (1, 1) & (0.8, 0), (1, 1), (1, 1) \\ (0.8, 0), (1, 1), (1, 1) & (0.8, 0), (1, 1), (1, 1) & (0.8, 0), (1, 1), (1, 1) \end{bmatrix}$$

Case 4: Random possible value for all unknown. Therefore, the rough neutrosophic multisets relation matrix resulted as  $M(\mathfrak{R}_6)$ .

$$M(\mathfrak{R}_6) = \begin{bmatrix} (0.9, 0), (1, 1), (1, 1) & (0.8, 0), (1, 1), (1, 1) & (0.9, 0), (1, 1), (1, 1) \\ (0.8, 0), (1, 1), (1, 1) & (0.7, 0), (1, 1), (1, 1) & (0.8, 0), (1, 1), (1, 1) \\ (0.7, 0), (1, 1), (1, 1) & (0.6, 0), (1, 1), (1, 1) & (0.7, 0), (1, 1), (1, 1) \end{bmatrix}$$

Step 6: Compute the comparison matrix using the formula  $D_{\mathfrak{R}}^i = T_{\mathfrak{R}}^i + I_{\mathfrak{R}}^i - F_{\mathfrak{R}}^i$  for all  $i$ , and select the maximum value for comparison table. The result is shown in Table 6 and Table 7, respectively.

	$j_1$	$j_2$	$j_3$
$\mathfrak{R}_1$			
$j_1$	(0.9, 0)	(0.9, 0)	(0.9, 0)
$j_2$	(0.8, 0)	(0.8, 0)	(0.8, 0)
$j_3$	(0.7, 0)	(0.7, 0)	(0.7, 0)
$\mathfrak{R}_2$			
$j_1$	(0.8, 0)	(0.8, 0)	(0.8, 0)
$j_2$	(0.7, 0)	(0.7, 0)	(0.7, 0)
$j_3$	(0.6, 0)	(0.6, 0)	(0.6, 0)
$\mathfrak{R}_3$			
$j_1$	(0.7, 0)	(0.7, 0)	(0.7, 0)
$j_2$	(0.8, 0)	(0.8, 0)	(0.8, 0)
$j_3$	(0.9, 0)	(0.9, 0)	(0.9, 0)
$\mathfrak{R}_4$			
$j_1$	(0.6, 0)	(0.6, 0)	(0.6, 0)
$j_2$	(0.7, 0)	(0.7, 0)	(0.7, 0)
$j_3$	(0.8, 0)	(0.8, 0)	(0.8, 0)
$\mathfrak{R}_5$			
$j_1$	(0.8, 0)	(0.8, 0)	(0.8, 0)
$j_2$	(0.8, 0)	(0.8, 0)	(0.8, 0)
$j_3$	(0.8, 0)	(0.8, 0)	(0.8, 0)
$\mathfrak{R}_6$			
$j_1$	(0.9, 0)	(0.8, 0)	(0.9, 0)
$j_2$	(0.8, 0)	(0.7, 0)	(0.8, 0)
$j_3$	(0.7, 0)	(0.6, 0)	(0.7, 0)

**Table 6:** Comparison matrix of rough neutrosophic multi relation  $\mathfrak{R}$ .

$J$	$j_1$	$j_2$	$j_3$
$J_1$			
$j_1$	0.9	0.9	0.9
$j_2$	0.8	0.8	0.8
$j_3$	0.7	0.7	0.7
$J_2$			
$j_1$	0.8	0.8	0.8
$j_2$	0.7	0.7	0.7
$j_3$	0.6	0.6	0.6
$J_3$			
$j_1$	0.7	0.7	0.7
$j_2$	0.8	0.8	0.8
$j_3$	0.9	0.9	0.9
$J_4$			
$j_1$	0.6	0.6	0.6
$j_2$	0.7	0.7	0.7
$j_3$	0.8	0.8	0.8
$J_5$			
$j_1$	0.8	0.8	0.8
$j_2$	0.8	0.8	0.8
$j_3$	0.8	0.8	0.8
$J_6$			
$j_1$	0.9	0.8	0.9
$j_2$	0.8	0.7	0.8
$j_3$	0.7	0.6	0.7

**Table 7:** Comparison table for rough neutrosophic multisets,  $J$

Step 7: Next we compute the row-sum, column-sum, and the score for all cases as shown in Table 8.

$J$	Row sum	Column sum	Score
$J_1$			
$j_1$	2.7	2.4	<b>0.3</b>
$j_2$	2.4	2.4	0
$j_3$	2.1	2.4	-0.3
$J_2$			
$j_1$	2.4	2.1	<b>0.3</b>
$j_2$	2.1	2.1	0
$j_3$	1.8	2.1	-0.3
$J_3$			
$j_1$	2.1	2.4	-0.3
$j_2$	2.4	2.4	0
$j_3$	2.7	2.4	<b>0.3</b>
$J_4$			
$j_1$	1.8	2.1	-0.3
$j_2$	2.1	2.1	0
$j_3$	2.4	2.1	<b>0.3</b>
$J_5$			
$j_1$	2.4	2.4	<b>0</b>
$j_2$	2.4	2.4	<b>0</b>
$j_3$	2.4	2.4	<b>0</b>
$J_6$			
$j_1$	2.6	2.4	<b>0.2</b>
$j_2$	2.3	2.1	<b>0.2</b>
$j_3$	2.0	2.4	-0.4

**Table 8:** Score of three jeans for all cases.

The relation of quality of jeans in shop G is successfully approximate by using rough neutrosophic multisets relation. Jean type  $j_1$  has the highest score of 0.3 for case 1, jean type  $j_3$  has the highest score of 0.3 for case 2, neither choose a jean or not for case 3, and jeans type  $j_1$  and  $j_2$  have a highest score of 0.2 for case 4. The different selection of jeans has resulted in different cases. From the scoring perspective, the highest value for

each unknown will result in the highest possibility to select the subject. Besides that, it cannot take the same possible values for each unknown at the same time because the score result will be equal to zero (case 3).

Based on the result, the customers should purchase the jeans of type  $j_1$  in the shop G and the manager should sell more jeans of type  $j_1$ .

## Conclusion

The successful discussion of rough neutrosophic multisets relation with application in marketing strategy is obtained in this paper. Firstly, this paper is defined the rough neutrosophic multisets relation with their properties and operations such as max, min, the composition of two rough neutrosophic multisets, inverse rough neutrosophic multisets, and symmetry, reflexive and transitive of rough neutrosophic multisets. The approximation set boundary of rough neutrosophic multisets was applied for rough neutrosophic multisets relation. This relation theory is useful to apply in marketing strategy problem by getting the real relation of goods sold in the market. Decision matrix analysis is further conducted to get the best result. For further work, the relation of two universe sets can be derived as a rough neutrosophic multisets relation of two universe sets.

## References

- [1] L. A. Zadeh, "Fuzzy sets," *Inf. Control*, 8(3), (1965), 338–353.
- [2] M. Hussain, "Fuzzy relation," Master Thesis Blekinge Institute of Technology School of Engineering, Department of Mathematics and Science, (2010).
- [3] K. T. Atanassov, "Intuitionistic Fuzzy Set," *Fuzzy Sets and Systems*, 20, (1986), 87–96.
- [4] P. Burillo, H. Bustince, and C. Arrosad, "Intuitionistic fuzzy relations. (Part I)," *Mathw. Soft Comput.*, 2, (1995), 5–38.
- [5] Z. Pawlak, "Rough sets," *Int. J. Comput. Inf. Sci.*, 11(5), (1982), 341–356.
- [6] P. K. Maji, R. Biswas, and A. R. Roy, "Soft set theory," *Comput. Math. with Appl.*, 45(4), (2003), 555–562.
- [7] M. Nicoletti, J. Uchoa, and M. Baptistini, "Rough relation properties," *Int. J. Appl.*, 11(3), (2001), 621–635.
- [8] K. V. Babitha and J. J. Sunil, "Soft set relations and functions," *Comput. Math. with Appl.*, 60(7), (2010), 1840–1849.
- [9] F. Smarandache, "A Unifying Field in Logics: Neutrosophic Logic, Neutrosophy, Neutrosophic set, Neutrosophic Probability", American Research Press, (1999), 1–141.
- [10] H. Yang, Z. Guo, and X. Liao, "On single valued neutrosophic relations," *J. Intell. Fuzzy Syst.*, 30(2), (2016), 1–20.
- [11] A. A. Salama, M. Eisa, and M. M. Abdelmoghny, "Neutrosophic Relations Database," *Int. J. Inf. Sci. Intell. Syst.*, 3(2), (2014), 33–46.
- [12] R. Chatterjee, P. Majumdar, and S. K. Samanta, "Single valued neutrosophic multisets," *Ann. Fuzzy Math. Informatics*, x(x), (2015), 499–514.
- [13] I. Deli, S. Broumi, and F. Smarandache, "On Neutrosophic refined sets and their applications in medical diagnosis," *J. New Theory*, (2015), 88–98.
- [14] S. Miyamoto, "Fuzzy multisets and their generalizations," *Multiset Process. Math. Comput. Sci. Mol. Comput. Points View*, 2235, (2001), 225–235.
- [15] T. K. Shinoj and S. J. John, "Intuitionistic Fuzzy Multisets and Its Application in Medical Diagnosis," *World Acad. Sci. Eng. Technol.*, 6(1), (2012), 1418–1421.
- [16] S. Broumi, I. Deli, and F. Smarandache, "Relations on neutrosophic multi sets with properties," *arXiv:1506.04025*, (2015), 1–15.
- [17] S. Broumi, I. Deli, and F. Smarandache, "Neutrosophic Refined Relations and Their Properties," *Neutrosophic Theory Its Appl.*, (2014), 228–248.
- [18] F. Smarandache, *Neutrosophic Perspectives: Triplets, Duplets, Multisets, Hybrid Operators, Modal Logic, Hedge Algebras. And Applications. Second extended and improved edition*, Pons, Bruxelles, 2017.
- [19] S. Broumi and F. Smarandache, "Extended Hausdorff Distance and Similarity Measures for Neutrosophic Refined Sets and Their Application in Medical Diagnosis," *Journal of New Theory*, 7, (2015), 64–78.
- [20] J. Ye and F. Smarandache, "Similarity Measure of Refined Single-Valued Neutrosophic Sets and Its Multicriteria Decision Making Method," *Neutrosophic Sets Syst.*, 12, (2016), 41–44.
- [21] S. Ye and J. Ye, "Dice similarity measure between single valued neutrosophic multisets and its application in medical diagnosis," *Neutrosophic Sets Syst.*, 6, (2014), 48–53.
- [22] K. Mondal and S. Pramanik, "Neutrosophic refined similarity measure based on cotangent function and its application to multi-attribute decision making," *J. New theory*, 8, (2015), 41–50.
- [23] K. Mondal and S. Pramanik, "Neutrosophic Refined Similarity Measure Based on Cotangent Function and its Application to Multi-attribute Decision Making," *Glob. J. Advanced Res*, (2015), 486–496.
- [24] S. Pramanik, D. Banerjee, and B. C. Giri, "Multi – Criteria Group Decision Making Model in Neutrosophic Refined Set and Its Application," *Glob. J. Eng. Sci. Res. Manag.*, 3(6), (2016), 12–18.

- [25] F. Karaaslan, "Multi-criteria decision-making method based on similarity measures under single valued neutrosophic refined and interval neutrosophic refined environments," arXiv:1512.03687v1, (2015).
- [26] D. Dubois and H. Prade, "Rough fuzzy sets and fuzzy rough sets," *Int. J. Gen. Syst.*, 17(2-3), (1990), 191–209.
- [27] S. Rizvi, H. J. Naqvi, and D. Nadeem, "Rough Intuitionistic Fuzzy Sets," *J. Comput. Inf. Syst.*, (2002).
- [28] W. Z. Wu and Y. H. Xu, "Rough approximations of intuitionistic fuzzy sets in crisp approximation spaces," *Proc. - 2010 7th Int. Conf. Fuzzy Syst. Knowl. Discov. FSKD 2010*, 1, (2010), 309–313.
- [29] S. Broumi, F. Smarandache, and M. Dhar, "Rough Neutrosophic Sets," *Ital. J. Pure Appl. Math.*, 32, (2014), 493–502.
- [30] Z.-L. Guo, Y.-L. Liu, and H.-L. Yang, "A Novel Rough Set Model in Generalized Single Valued Neutrosophic Approximation Spaces and Its Application," *Symmetry (Basel)*, 9(7), (2017), 119.
- [31] S. Broumi and F. Smarandache, "Interval Neutrosophic Rough Set," *Neutrosophic Sets Syst.*, 7, (2014), 23–31.
- [32] H. L. Yang, C. L. Zhang, Z. L. Guo, Y. L. Liu, and X. Liao, "A hybrid model of single valued neutrosophic sets and rough sets: single valued neutrosophic rough set model," *Soft Comput.*, 21, (2017), 6253–6267.
- [33] Surapati. P and K. Mondal, "Rough Bipolar Neutrosophic Set," *Glob. J. Eng. Sci. Res. Manag.*, 3, (2016), 71–81.
- [34] E. Marei, "Single Valued Neutrosophic Soft Approach to Rough Sets, Theory and Application," *Neutrosophic Sets Syst.*, 20, (2018), 76–85.
- [35] S. Alias, D. Mohamad, and A. Shuib, "Rough Neutrosophic Multisets," *Neutrosophic Sets Syst.*, 16, (2017), 80–88.
- [36] T. K. Samanta and B. Sarkar, "Fuzzy Rough Relations," arxiv:1109.1803, 1, (2011), 10-17.
- [37] X. T. Nguyen, V. D. Nguyen, and D. D. Nguyen, "Rough Fuzzy Relation on Two Universal Sets," *Int. J. Intell. Syst. Appl.*, 6(4), (2014), 49–55.
- [38] K. Mondal, S. Pramanik, and F. Smarandache, "Multi-attribute decision making based on rough neutrosophic variational coefficient similarity measure," *Neutrosophic Sets Syst.*, 13, (2016), 3–17.
- [39] S. Pramanik, R. Roy, T. K. Roy, and F. Smarandache, "Multi-Attribute Decision Making Based on Several Trigonometric Hamming Similarity Measures under Interval Rough Neutrosophic Environment," *Neutrosophic Sets Syst. Neutrosophic*, 9, (2018), 10–118.
- [40] K. Mondal and S. Pramanik, "Decision Making Based on Some similarity Measures under Interval Rough Neutrosophic Environment," *Neutrosophic Sets Syst. Neutrosophic*, 10, (2015), 46–57.
- [41] S. Pramanik, R. Roy, T. K. Roy, and F. Smarandache, "Multi criteria decision making using correlation coefficient under rough neutrosophic environment," *Neutrosophic Sets Syst. Neutrosophic*, 17, (2017), 29–36.
- [42] K. Mondal and S. Pramanik, "Rough Neutrosophic Multi-Attribute Decision-Making Based on Rough Accuracy Score Function," *Neutrosophic Sets Syst.*, 7, (2015), 8–17.
- [43] K. Mondal, S. Pramanik, and F. Smarandache, "Several Trigonometric Hamming Similarity Measures of Rough Neutrosophic Sets and their Applications in Decision," *New Trend in Neutrosophic and Application*, 1, (2016), 93-103.
- [44] K. Mondal and S. Pramanik, "Rough Neutrosophic Multi-Attribute Decision-Making Based on Grey Relational Analysis," *Neutrosophic Sets Syst.*, 7, (2015), 8–17.

Received: June 21, 2018. Accepted: July 18, 2018.





# Fuzzy Neutrosophic $\alpha^m$ -Closed Sets in Fuzzy Neutrosophic Topological Spaces

Fatimah M. Mohammed<sup>1,\*</sup> and Shaymaa F. Matar<sup>2</sup>

<sup>1</sup>Department of Mathematics, College of Education for Pure Sciences, Tikrit University, Tikrit, IRAQ

\*Corresponding author, Email address: [nafea\\_y2011@yahoo.com](mailto:nafea_y2011@yahoo.com)

<sup>2</sup>Department of Mathematics, College of Education for Pure Sciences, Tikrit University, Tikrit, IRAQ

E-mail: [shaimaa.1986@yahoo.com](mailto:shaimaa.1986@yahoo.com)

**Abstract.** In this paper, we state a new class of sets and called them fuzzy neutrosophic  $\alpha^m$ -closed sets, and we prove some theorem related to this definition. Then, we investigate the relation between fuzzy neutrosophic  $\alpha^m$ -closed sets, fuzzy neutrosophic  $\alpha$  closed sets, fuzzy neutrosophic closed sets, fuzzy neutrosophic semi closed sets and fuzzy neutrosophic pre closed sets. On the other hand, some properties of the fuzzy neutrosophic  $\alpha^m$ -closed set are given.

**Keywords:** fuzzy neutrosophic closed sets, fuzzy neutrosophic  $\alpha^m$ -closed sets, fuzzy neutrosophic topology.

## 1. Introduction:

The concept of fuzzy sets was introduced by Zadeh in 1965 [14]. Then the fuzzy set theory are extension by many researchers. The concept of intuitionistic fuzzy sets (IFS) was one of the extension sets by K. Atanassov in 1983 [2, 3, 4], when fuzzy set give the degree of membership of an element in the sets, the intuitionistic fuzzy sets give a degree of membership and a degree of non-membership. Then, several researches were conducted on the generalizations of the notion of intuitionistic fuzzy sets, one of them was Floretin Smarandache in 2010 [7] when he developed another membership in addition to the two memberships which was defined in intuitionistic fuzzy sets and called it neutrosophic set.

The concept of neutrosophic sets was defined with membership, non-membership and indeterminacy degrees. In the last year, (2017) Veereswari [13] introduced fuzzy neutrosophic topological spaces. This concept is the solution and representation of the problems with various fields.

Neutrosophic topological spaces and many applications have been investigated by Salama et al. in [9-12]

In this paper, the concept of  $\alpha^m$ -closed sets in double fuzzy topological spaces [6] were developed. We discussed some new class of sets and called them fuzzy neutrosophic  $\alpha^m$ -closed sets in fuzzy neutrosophic topological spaces, and we also discussed some new properties and examples based of this defined concept.

## 2. Basic definitions and terminologies

**Definition 2.1** [8]: A neutrosophic topology ( $NT$ , for short) on a non-empty set  $X$  is a family  $\tau$  of neutrosophic subsets of  $X$  satisfying the following axioms:

- i)  $\emptyset, X_N \in \tau$ .

- ii)  $A_1 \cap A_2 \in \tau$  for any  $A_1$  and  $A_2 \in \tau$ .
- iii)  $\cup A_j \in \tau$  for any  $\{A_j : j \in J\} \subseteq \tau$ .

In this case the pair  $(X, \tau)$  is called a neutrosophic topological space (NTS, for short) in  $X$ . The elements in  $\tau$  are called neutrosophic open sets ( $N$ -open sets for short) in  $X$ . A  $N$ -set is said to be neutrosophic closed set ( $N$ -closed set, for short) if and only if its complement is a  $N$ -open set.

**Definition 2.2 [1, 13]:** Let  $X$  be a non-empty fixed set. A fuzzy neutrosophic set (FNS, for short),  $\lambda_N$  is an object having the form  $\lambda_N = \{ \langle x, \mu_{\lambda_N}(x), \sigma_{\lambda_N}(x), \nu_{\lambda_N}(x) \rangle : x \in X \}$  where the functions  $\mu_{\lambda_N}, \sigma_{\lambda_N}, \nu_{\lambda_N} : X \rightarrow [0, 1]$  denote the degree of membership function (namely  $\mu_{\lambda_N}(x)$ ), the degree of indeterminacy function (namely  $\sigma_{\lambda_N}(x)$ ) and the degree of non-membership function (namely  $\nu_{\lambda_N}(x)$ ) respectively, of each set  $\lambda_N$  we have,  $0 \leq \mu_{\lambda_N}(x) + \sigma_{\lambda_N}(x) + \nu_{\lambda_N}(x) \leq 3$ , for each  $x \in X$ .

**Remark 2.3 [13]:** FNS  $\lambda_N = \{ \langle x, \mu_{\lambda_N}(x), \sigma_{\lambda_N}(x), \nu_{\lambda_N}(x) \rangle : x \in X \}$  can be identified to an ordered triple  $\langle \mu_{\lambda_N}, \sigma_{\lambda_N}, \nu_{\lambda_N} \rangle$  in  $[0, 1]$  on  $X$ .

**Definition 2.4[13]:** Let  $X$  be a non-empty set and the FNSs  $\lambda_N$  and  $\beta_N$  be in the form:

$\lambda_N = \{ \langle x, \mu_{\lambda_N}(x), \sigma_{\lambda_N}(x), \nu_{\lambda_N}(x) \rangle : x \in X \}$  and,  
 $\beta_N = \{ \langle x, \mu_{\beta_N}(x), \sigma_{\beta_N}(x), \nu_{\beta_N}(x) \rangle : x \in X \}$  on  $X$  then:

- i.  $\lambda_N \subseteq \beta_N$  iff  $\mu_{\lambda_N}(x) \leq \mu_{\beta_N}(x), \sigma_{\lambda_N}(x) \leq \sigma_{\beta_N}(x)$  and  $\nu_{\lambda_N}(x) \geq \nu_{\beta_N}(x)$  for all  $x \in X$ ,
- ii.  $\lambda_N = \beta_N$  iff  $\lambda_N \subseteq \beta_N$  and  $\beta_N \subseteq \lambda_N$ ,
- iii.  $\underline{\lambda}_N = \{ \langle x, \nu_{\lambda_N}(x), 1 - \sigma_{\lambda_N}(x), \mu_{\lambda_N}(x) \rangle : x \in X \}$
- iv.  $\lambda_N \cup \beta_N = \{ \langle x, \text{Max}(\mu_{\lambda_N}(x), \mu_{\beta_N}(x)), \text{Max}(\sigma_{\lambda_N}(x), \sigma_{\beta_N}(x)), \text{Min}(\nu_{\lambda_N}(x), \nu_{\beta_N}(x)) \rangle : x \in X \}$ ,
- v.  $\lambda_N \cap \beta_N = \{ \langle x, \text{Min}(\mu_{\lambda_N}(x), \mu_{\beta_N}(x)), \text{Min}(\sigma_{\lambda_N}(x), \sigma_{\beta_N}(x)), \text{Max}(\nu_{\lambda_N}(x), \nu_{\beta_N}(x)) \rangle : x \in X \}$ ,
- vi.  $\underline{0}_N = \langle x, 0, 0, 1 \rangle$  and  $\underline{1}_N = \langle x, 1, 1, 0 \rangle$ .

**Definition 2.5 [13]:** A Fuzzy neutrosophic topology (FNT, for short) on a non-empty set  $X$  is a family  $\tau_N$  of fuzzy neutrosophic subsets in  $X$  satisfying the following axioms.

- i.  $\underline{0}_N, \underline{1}_N \in \tau_N$ ,
- ii.  $\lambda_{N1} \cap \lambda_{N2} \in \tau_N$  for any  $\lambda_{N1}, \lambda_{N2} \in \tau_N$ ,
- iii.  $\cup \lambda_{Nj} \in \tau_N, \forall \{ \lambda_{Nj} : j \in J \} \subseteq \tau_N$ .

In this case the pair  $(X, \tau_N)$  is called fuzzy neutrosophic topological space (FNTS, for short). The elements of  $\tau$  are called fuzzy neutrosophic open sets ( $F_N$ -open set, for short). The complement of  $F_N$ -open sets in the FNTS  $(X, \tau_N)$  are called fuzzy neutrosophic closed sets ( $F_N$ -closed set, for short).

**Definition 2.6 [13]:** Let  $(X, \tau_N)$  be FNTS and  $\lambda_N = \langle x, \mu_{\lambda_N}, \sigma_{\lambda_N}, \nu_{\lambda_N} \rangle$  be FNS in  $X$ . Then, the fuzzy neutrosophic closure of  $\lambda_N$  (FNCL, for short) and fuzzy neutrosophic interior of  $\lambda_N$  (FNInt, for short) are defined by:

$$\text{FNCl}(\lambda_N) = \cap \{ \beta_N: \beta_N \text{ is } F_N\text{-closed set in } X \text{ and } \lambda_N \subseteq \beta_N \},$$

$$\text{FNInt}(\lambda_N) = \cup \{ \beta_N: \beta_N \text{ is } F_N\text{-open set in } X \text{ and } \beta_N \subseteq \lambda_N \}.$$

Note that  $\text{FNCl}(\lambda_N)$  be  $F_N$ -closed set and  $\text{FNInt}(\lambda_N)$  be  $F_N$ -open set in  $X$ .

Further,

$$\text{i. } \lambda_N \text{ be } F_N\text{-closed set in } X \text{ iff } \text{FNCl}(\lambda_N) = \lambda_N,$$

$$\text{ii. } \lambda_N \text{ be } F_N\text{-open set in } X \text{ iff } \text{FNInt}(\lambda_N) = \lambda_N.$$

**Proposition 2.7 [13]:** Let  $(X, \tau_N)$  be FNTS and  $\lambda_N, \beta_N$  are FNSs in  $X$ . Then, the following properties hold:

$$\text{i. } \text{FNInt}(\lambda_N) \subseteq \lambda_N \text{ and } \lambda_N \subseteq \text{FNCl}(\lambda_N),$$

$$\text{ii. } \lambda_N \subseteq \beta_N \Rightarrow \text{FNInt}(\lambda_N) \subseteq \text{FNInt}(\beta_N) \text{ and } \lambda_N \subseteq \beta_N \Rightarrow \text{FNCl}(\lambda_N) \subseteq \text{FNCl}(\beta_N),$$

$$\text{iii. } \text{Int}(\text{FNInt}(\lambda_N)) = \text{FNInt}(\lambda_N) \text{ and } \text{FNCl}(\text{FNCl}(\lambda_N)) = \text{FNCl}(\lambda_N),$$

$$\text{iv. } \text{FNInt}(\lambda_N \cap \beta_N) = \text{FNInt}(\lambda_N) \cap \text{FNInt}(\beta_N) \text{ and } \text{FNCl}(\lambda_N \cup \beta_N) = \text{FNCl}(\lambda_N) \cup \text{FNCl}(\beta_N),$$

$$\text{v. } \text{FNInt}(\underline{1}_N) = \underline{1}_N \text{ and } \text{FNCl}(\underline{1}_N) = \underline{1}_N,$$

$$\text{vi. } \text{FNInt}(\underline{0}_N) = \underline{0}_N \text{ and } \text{FNCl}(\underline{0}_N) = \underline{0}_N.$$

**Definition 2.8 [2]:** FNS  $\lambda_N$  in FNTS  $(X, \tau_N)$  is called:

$$\text{i. } \text{fuzzy neutrosophic semi-open set (FNS-open, for short) if } \lambda_N \subseteq \text{FNCl}(\text{FNInt}(\lambda_N)),$$

$$\text{ii. } \text{fuzzy neutrosophic semi-closed set (FNS-closed, for short) if } \text{FNInt}(\text{FNCl}(\lambda_N)) \subseteq \lambda_N,$$

$$\text{iii. } \text{fuzzy neutrosophic pre-open set (FNP-open, for short) if } \lambda_N \subseteq \text{FNInt}(\text{FNCl}(\lambda_N)).$$

$$\text{iv. } \text{fuzzy neutrosophic pre-closed set (FNP-closed, for short) if } \text{FNCl}(\text{FNInt}(\lambda_N)) \subseteq \lambda_N,$$

$$\text{v. } \text{fuzzy neutrosophic } \alpha\text{-open set (FN}\alpha\text{-open, for short) if } \lambda_N \subseteq \text{FNInt}(\text{FNCl}(\text{FNInt}(\lambda_N))),$$

$$\text{vi. } \text{fuzzy neutrosophic } \alpha\text{-closed set (FN}\alpha\text{-closed, for short) if } \text{FNCl}(\text{FNInt}(\text{FNCl}(\lambda_N))) \subseteq \lambda_N.$$

### 3. Fuzzy Neutrosophic Alpha<sup>m</sup> - Closed Sets in Fuzzy Neutrosophic Topological Spaces.

Now, the concept of fuzzy neutrosophic Alpha<sup>m</sup>-closed set in fuzzy neutrosophic topological space is introduced, as follows:

**Definition 3.1:** Fuzzy neutrosophic subset  $\lambda_N$  of FNTS  $(X, \tau_N)$  is called fuzzy neutrosophic Alpha<sup>m</sup>-closed set (FN $\alpha^m$ -closed set, for short) if  $\text{FNInt}(\text{FNCl}(\lambda_N)) \subseteq U_N$ , wherever  $\lambda_N \subseteq U_N$  and  $U_N$  be FN $\alpha$ -open set. And  $\lambda_N$  is said to be fuzzy neutrosophic Alpha<sup>m</sup>-open set (FN $\alpha^m$ -open set, for short) in  $(X, \tau_N)$  if the complement  $\underline{1}_N - \lambda_N$  be FN $\alpha^m$ -closed set in  $(X, \tau_N)$ .

**Proposition 3.2:** For any FNS, the following statements satisfy:

$$\text{i. } \text{Every } F_N\text{-open set is FN}\alpha\text{-open set.}$$

$$\text{ii. } \text{Every FN}\alpha\text{-closed set is FN}\alpha^m\text{-closed set.}$$

$$\text{iii. } \text{Every } F_N\text{-closed set is FN}\alpha^m\text{-closed set.}$$

$$\text{iv. } \text{Every FNS-closed set is FN}\alpha^m\text{-closed set.}$$

**Proof:**

i. Let  $\lambda_N = \{ \langle x, \mu_{\lambda_N}(x), \sigma_{\lambda_N}(x), \nu_{\lambda_N}(x) \rangle : x \in X \}$  be  $F_N$ -open set in FNTS  $(X, \tau_N)$ . Then, by **Definition 2.6 (ii)** we get,

$$\lambda_N = \text{FNInt}(\lambda_N) \dots (1)$$

And, by **Proposition 2.7 (i)** we get,  $\lambda_N \subseteq \text{FNCl}(\lambda_N)$ . But,  $\lambda_N \subseteq \text{FNCl}(\text{FNInt}(\lambda_N))$ .

Then,  $\text{FNInt}(\lambda_N) \subseteq \text{FNInt}(\text{FNCl}(\text{FNInt}(\lambda_N)))$ .

Therefore, by **(1)** we get,  $\lambda_N \subseteq \text{FNInt}(\text{FNCl}(\text{FNInt}(\lambda_N)))$ . Hence,  $\lambda_N$  be  $\text{FN}\alpha$ -open set in  $(X, \tau_N)$ .

ii. Let  $\lambda_N = \{ \langle x, \mu_{\lambda_N}(x), \sigma_{\lambda_N}(x), \nu_{\lambda_N}(x) \rangle : x \in X \}$  be  $\text{FN}\alpha$ -closed set in FNTS  $(X, \tau_N)$ .

Then,  $\text{FNCl}(\text{FNInt}(\text{FNCl}(\lambda_N))) \subseteq \lambda_N$ .

Now, let  $\beta_N$  be  $F_N$ -open set such that,  $\lambda_N \subseteq \beta_N$ .

Since,  $\beta_N$  be  $F_N$ -open set then, is  $\text{FN}\alpha$ -open set by **(i)**. Then,  $\text{FNInt}(\text{FNCl}(\lambda_N)) \subseteq \text{FNInt}(\lambda_N) \subseteq \lambda_N \subseteq \beta_N$ .

Therefore,  $\text{FNInt}(\text{FNCl}(\lambda_N)) \subseteq \beta_N$ .

Hence,  $\lambda_N$  be  $\text{FN}\alpha^m$ -closed set in  $(X, \tau_N)$ .

iii. Let  $\lambda_N = \{ \langle x, \mu_{\lambda_N}(x), \sigma_{\lambda_N}(x), \nu_{\lambda_N}(x) \rangle : x \in X \}$  is  $F_N$ -closed set in

FNTS  $(X, \tau_N)$ . Then, by **Definition 2.6 (i)**. We get,  $\lambda_N = \text{FNCl}(\lambda_N) \dots (1)$ .

And, by **Proposition 2.7 (i)**. We get,  $\text{FNInt}(\lambda_N) \subseteq \lambda_N \dots (2)$ . But,

$\text{FNInt}(\text{FNCl}(\lambda_N)) \subseteq \text{FNCl}(\lambda_N)$ . Then, by **(1)**. We get,

$\text{FNInt}(\text{FNCl}(\lambda_N)) \subseteq \lambda_N$ . Now, let  $\beta_N$  is  $F_N$ -open set such that,  $\lambda_N \subseteq \beta_N$ . By **Proposition 3.2 (i)**. If,  $\beta_N$  is  $F_N$ -

open set. Then, is  $\text{FN}\alpha$ -open set. Then,  $\text{FNInt}(\text{FNCl}(\lambda_N)) \subseteq \lambda_N \subseteq \beta_N$ . Therefore,  $\text{FNInt}(\text{FNCl}(\lambda_N)) \subseteq \beta_N$ .

Hence,  $\lambda_N$  is  $\text{FN}\alpha^m$ -closed set in  $(X, \tau_N)$ .

iv. Let  $\lambda_N = \{ \langle x, \mu_{\lambda_N}(x), \sigma_{\lambda_N}(x), \nu_{\lambda_N}(x) \rangle : x \in X \}$  be  $F_N$ -closed set in FNTS  $(X, \tau_N)$ .

Then,  $\text{FNInt}(\text{FNCl}(\lambda_N)) \subseteq \lambda_N$ .

Now, let  $\beta_N$  be  $F_N$ -open set such that,  $\lambda_N \subseteq \beta_N$

Since,  $\beta_N$  be  $F_N$ -open set then, is  $\text{FN}\alpha$ -open set, by **(i)**

Then,  $\text{FNInt}(\text{FNCl}(\lambda_N)) \subseteq \lambda_N \subseteq \beta_N$ .

Therefore,  $\text{FNInt}(\text{FNCl}(\lambda_N)) \subseteq \beta_N$ .

Hence,  $\lambda_N$  be  $\text{FN}\alpha^m$ -closed set in  $(X, \tau_N)$ .

**Remark 3.3:** The converse of **Proposition 3.2** is not true in general and we can show it by the following examples:

**Example 3.4:**

i. Let  $X = \{x\}$  define FNSs  $\lambda_N$  and  $\beta_N$  in  $X$  as follows:

$$\lambda_N = \{ \langle x, 0.7, 0.6, 0.5 \rangle : x \in X \}, \beta_N = \{ \langle x, 0.8, 0.9, 0.4 \rangle :$$

$$x \in X \}.$$

And the family  $\tau_N = \{ \underline{0}_N, \underline{1}_N, \lambda_N, \beta_N \}$  be FNT such that,  $\underline{1}_N \tau_N = \{ \underline{1}_N, \underline{0}_N, \langle x, 0.5, 0.4, 0.7 \rangle, \langle x, 0.4, 0.1, 0.8 \rangle \}$ .

Now if,

$$\omega_N = \{ \langle x, 0.8, 0.6, 0.5 \rangle : x \in X \}.$$

Then,  $\text{FNInt}(\omega_N) = \{ \langle x, 0.7, 0.6, 0.5 \rangle : x \in X \}$ ,  $\text{FNCl}(\text{FNInt}(\omega_N)) = \underline{1}_N$ , and  $\text{FNInt}(\text{FNCl}(\text{FNInt}(\omega_N))) = \underline{1}_N$ .

Therefore,  $\omega_N \subseteq \text{FNInt}(\text{FNCl}(\text{FNInt}(\omega_N)))$ .

Hence,  $\omega_N$  be  $\text{FN}\alpha$ -open set. But, not  $F_N$ -open set.

ii. Let  $X = \{x\}$  define FNSs  $\lambda_N, \beta_N, \eta_N$  and  $\Psi_N$  in  $X$  as follows:

$$\lambda_N = \{ \langle x, 1, 0.5, 0.7 \rangle : x \in X \}, \beta_N = \{ \langle x, 0, 0.9, 0.2 \rangle : x \in X \},$$

$$\eta_N = \{ \langle x, 1, 0.9, 0.2 \rangle : x \in X \} \text{ and } \Psi_N = \{ \langle x, 0, 0.5, 0.7 \rangle : x \in X \}$$

And the family  $\tau_N = \{ \underline{0}_N, \underline{1}_N, \lambda_N, \beta_N, \eta_N, \Psi_N \}$  be FNT such that,  $\underline{1}_N - \tau_N = \{ \underline{1}_N, \underline{0}_N, \langle x, 0.7, 0.5, 1 \rangle, \langle x, 0.2, 0.1, 0 \rangle, \langle x, 0.2, 0.1, 1 \rangle, \langle x, 0.7, 0.5, 0 \rangle \}$

Now if,  $\omega_N = \{ \langle x, 0, 0.4, 0.8 \rangle : x \in X \}$  and  $U_N = \{ \langle x, 0, 0.5, 0.7 \rangle : x \in X \}$ .

Where,  $U_N$  be  $F_N$ -open set such that,  $\omega_N \subseteq U_N$ .

Since,  $U_N$  be  $F_N$ -open set then, is  $\text{FN}\alpha$ -open set by **Proposition 3.2 (i)**.

Then,  $\text{FNCl}(\omega_N) = \{ \langle x, 0.7, 0.5, 0 \rangle : x \in X \}$  and  $\text{FNInt}(\text{FNCl}(\omega_N)) = \{ \langle x, 0, 0.5, 0.7 \rangle : x \in X \}$ .

Therefore,  $\text{FNInt}(\text{FNCl}(\omega_N)) \subseteq U_N$ .

Hence,  $\omega_N$  be  $\text{FN}\alpha^m$ -closed set.

But,  $\text{FNCl}(\omega_N) = \{ \langle x, 0.7, 0.5, 0 \rangle : x \in X \}$ ,

$\text{FNInt}(\text{FNCl}(\omega_N)) = \{ \langle x, 0, 0.5, 0.7 \rangle : x \in X \}$  and

$\text{FNCl}(\text{FNInt}(\text{FNCl}(\omega_N))) = \{ \langle x, 0.7, 0.5, 0 \rangle : x \in X \}$

Therefore,  $\text{FNCl}(\text{FNInt}(\text{FNCl}(\omega_N))) \not\subseteq \omega_N$ . Hence,  $\omega_N$  be not  $\text{FN}\alpha$ -closed set.

iii. Take, the example which defined in ii. Then, we can see  $\omega_N$  be  $\text{FN}\alpha^m$ -closed set. But, not  $F_N$ -closed set.

Take again, the example which defined in ii. Then,  $\omega_N$  be  $\text{FN}\alpha^m$ -closed set. But, not FNS-closed set.

**Remark 3.5:** The relation between FNP-closed sets and  $\text{FN}\alpha^m$ -closed sets are independent and we can show it by the following examples.

**Example 3.6: (1)** Let  $X = \{x\}$  define FNSs  $\lambda_N$  and  $\beta_N$  in  $X$  as follows:

$$\lambda_N = \{ \langle x, 0.1, 0.2, 0.4 \rangle : x \in X \}, \beta_N = \{ \langle x, 0.7, 0.5, 0.2 \rangle : x \in X \},$$

And, the family  $\tau_N = \{ \underline{0}_N, \underline{1}_N, \lambda_N, \beta_N \}$  be FNT such that,  $\underline{1}_N - \tau_N = \{ \underline{1}_N, \underline{0}_N, \langle x, 0.4, 0.8, 0.1 \rangle, \langle x, 0.2, 0.5, 0.7 \rangle \}$ .

Now if,  $\omega_N = \{ \langle x, 0.1, 0.3, 0.4 \rangle : x \in X \}$  and

$U_N = \{ \langle x, 0.7, 0.5, 0.2 \rangle : x \in X \}$  where,  $U_N$  be  $F_N$ -open set such that,  $\omega_N \subseteq U_N$ .

Since,  $U_N$  be  $F_N$ -open set then, is  $\text{FN}\alpha$ -open set by **Proposition 3.2 (i)**

Then,  $\text{FNCl}(\omega_N) = \{ \langle x, 0.4, 0.8, 0.1 \rangle : x \in X \}$  and

$\text{FNInt}(\text{FNCl}(\omega_N)) = \{ \langle x, 0.1, 0.2, 0.4 \rangle : x \in X \}$ . Therefore,  $\text{FNInt}(\text{FNCl}(\omega_N)) \subseteq U_N$ .

Hence,  $\omega_N$  be  $\text{FN}\alpha^m$ -closed set.

But,  $\text{FNInt}(\omega_N) = \{ \langle x, 0.1, 0.2, 0.4 \rangle : x \in X \}$ ,

$\text{FNCl}(\text{FNInt}(\omega_N)) = \{ \langle x, 0.4, 0.8, 0.1 \rangle : x \in X \}$ . Therefore,  $\text{FNCl}(\text{FNInt}(\omega_N)) \not\subseteq \omega_N$ .

Hence,  $\omega_N$  be not FNP-closed set.

(2) Let  $X = \{a, b\}$  define FNS  $\lambda_N$  in  $X$  as follows:

$\lambda_N = \langle x, (a \setminus 0.5, b \setminus 0.5), (a \setminus 0.5, b \setminus 0.5), (a \setminus 0.4, b \setminus 0.5) \rangle$ . And the family  $\tau_N = \{ \underline{0}_N, \underline{1}_N, \lambda_N \}$  be FNT.

Such that,  $\underline{1}_N - \tau_N = \{ \underline{1}_N, \underline{0}_N, \langle x, (a \setminus 0.4, b \setminus 0.5), (a \setminus 0.5, b \setminus 0.5), (a \setminus 0.5, b \setminus 0.5) \rangle \}$ .

Now if,  $\omega_N = \langle x, (a \setminus 0.5, b \setminus 0.4), (a \setminus 0.5, b \setminus 0.5), (a \setminus 0.6, b \setminus 0.5) \rangle$  And,  $U_N = \lambda_N$  be  $F_N$ -open set such that,  $\omega_N \subseteq U_N$ .

Since,  $U_N$  be  $F_N$ -open set then, is  $FN\alpha$ -open set by **Proposition 3.2 (i)**

Then,  $FNInt(\omega_N) = \underline{0}_N$  and  $FNCl(FNInt(\omega_N)) = \underline{0}_N$ .

Therefore,  $FNCl(FNInt(\omega_N)) \subseteq \omega_N$ . Hence,  $\omega_N$  be FNP-closed set.

But,  $FNCl(\omega_N) = \underline{1}_N$  and  $FNInt(FNCl(\omega_N)) = \underline{1}_N$ .

Therefore,  $FNInt(FNCl(\omega_N)) \not\subseteq U_N$ . Hence,  $\omega_N$  be not  $FN\alpha^m$ - closed set.

**Proposition 3.7:** If  $\lambda_N$  be  $FN\alpha^m$ - closed set and  $\lambda_N \subseteq \eta_N \subseteq FNInt(FNCl(\lambda_N))$ , Then,  $\eta_N$  be  $FN\alpha^m$ - closed set.

**Proof:** Let  $\lambda_N = \{ \langle x, \mu_{\lambda_N}(x), \sigma_{\lambda_N}(x), \nu_{\lambda_N}(x) \rangle : x \in X \}$  be  $FN\alpha^m$ - closed set such that,  $\lambda_N \subseteq \eta_N \subseteq FNInt(FNCl(\lambda_N))$ .

Now let  $\beta_N$  be  $FN\alpha$ - open set such that,  $\eta_N \subseteq \beta_N$ .

Since,  $\lambda_N$  be  $FN\alpha^m$ -closed set then, we have

$FNInt(FNCl(\lambda_N)) \subseteq \beta_N$ , where  $\lambda_N \subseteq \beta_N$ .

Since,  $\lambda_N \subseteq \eta_N$  and  $\eta_N \subseteq FNInt(FNCl(\lambda_N))$  we get,

$FNInt(FNCl(\eta_N)) \subseteq FNInt(FNCl(FNInt(FNCl(\lambda_N)))) \subseteq FNInt(FNCl(\lambda_N)) \subseteq \beta_N$ .

Therefore,  $FNInt(FNCl(\eta_N)) \subseteq \beta_N$ . Hence,  $\eta_N$  be  $FN\alpha^m$ - closed set in  $(X, \tau_N)$ .

**Proposition 3.8:** Let  $(X, \tau_N)$  be FNTS. So, the intersection of two  $FN\alpha^m$ -closed sets be  $FN\alpha^m$ -closed set.

**Proof:** Let  $\lambda_N$  and  $\beta_N$  are FNS-closed sets on FNTS  $(X, \tau_N)$

Then,  $FNInt(FNCl(\lambda_N)) \subseteq \lambda_N \dots \dots (1)$

And,  $FNInt(FNCl(\beta_N)) \subseteq \beta_N \dots \dots (2)$

Consider  $\lambda_N \cap \beta_N \supseteq FNInt(FNCl(\lambda_N)) \cap FNInt(FNCl(\beta_N))$

$$= FNInt(FNCl(\lambda_N) \cap FNCl(\beta_N))$$

$$\supseteq FNInt(FNCl(\lambda_N \cap \beta_N)).$$

Therefore,  $FNInt(FNCl(\lambda_N \cap \beta_N)) \subseteq \lambda_N \cap \beta_N$

Now, let  $\eta_N$  be  $F_N$ -open set such that,  $\lambda_N \cap \beta_N \subseteq \eta_N$ .

Since,  $\eta_N$  be  $F_N$ -open set then it is  $FN\alpha$ -open set, by **Proposition 3.2 (i)**.

Then,  $FNInt(FNCl(\lambda_N \cap \beta_N)) \subseteq \lambda_N \cap \beta_N \subseteq \eta_N$ .

Therefore,  $FNInt(FNCl(\lambda_N \cap \beta_N)) \subseteq \eta_N$ . Hence,  $\lambda_N \cap \beta_N$  be  $FN\alpha^m$ -closed set in  $(X, \tau_N)$ .

**Remark 3.9:** The union of any  $FN\alpha^m$ -closed sets is not necessary to be  $FN\alpha^m$ -closed set and we can show it by the following example.

**Example 3.10:** Take, **Example 3.4 (ii)** if,

$\omega_{N1} = \{ \langle x, 0.4, 0.5, 1 \rangle : x \in X \}$  and  $\omega_{N2} = \{ \langle x, 0.2, 0, 0.8 \rangle : x \in X \}$ . And  $U_N = \{ \langle x, 1, 0.5, 0.7 \rangle : x \in X \}$

Then,  $FNCl(\omega_{N1}) = \{ \langle x, 0.7, 0.5, 1 \rangle : x \in X \}$  and  $FNInt(FNCl(\omega_{N1})) = \underline{0}_N$ .

Therefore,  $FNInt(FNCl(\omega_{N1})) \subseteq U_N$ .

Hence,  $\omega_{N1}$  be  $FN\alpha^m$ - closed set.

And,  $\text{FNCl}(\omega_{N2}) = \{ \langle x, 0.2, 0.1, 0 \rangle : x \in X \}$ ,  $\text{FNInt}(\text{FNCl}(\omega_{N2})) = \underline{0}_N$ .

Therefore,  $\text{FNInt}(\text{FNCl}(\omega_{N2})) \subseteq U_N$ . Hence,  $\omega_{N2}$  be  $\text{FN}\alpha^m$ -closed set.

Therefore,  $\omega_{N1} \cup \omega_{N2}$  be not  $\text{FN}\alpha^m$ -closed set.

**Definition 3.11:** Let  $(X, \tau_N)$  be FNTS and  $\lambda_N = \langle x, \mu_{\lambda_N}(x), \sigma_{\lambda_N}(x), \nu_{\lambda_N}(x) \rangle$  be FNS in  $X$ . Then, the fuzzy neutrosophic Alpha<sup>m</sup> closure of  $\lambda_N$  ( $\text{FN}\alpha^m\text{Cl}$ , for short) and fuzzy neutrosophic Alpha<sup>m</sup> interior of  $\lambda_N$  ( $\text{FN}\alpha^m\text{Int}$ , for short) are defined by:

- i.  $\text{FN}\alpha^m\text{Cl}(\lambda_N) = \cap \{ \beta_N : \beta_N \text{ is } \text{FN}\alpha^m\text{-closed set in } X \text{ and } \lambda_N \subseteq \beta_N \}$ ,
- ii.  $\text{FN}\alpha^m\text{Int}(\lambda_N) = \cup \{ \beta_N : \beta_N \text{ is } \text{FN}\alpha^m\text{-open set in } X \text{ and } \beta_N \subseteq \lambda_N \}$ .

**Proposition 3.12:** Let  $(X, \tau_N)$  be FNTS and  $\lambda_N, \beta_N$  are FNSs in  $X$ . Then the following properties hold:

- i.  $\text{FN}\alpha^m\text{Cl}(\underline{0}_N) = \underline{0}_N$  and  $\text{FN}\alpha^m\text{Cl}(\underline{1}_N) = \underline{1}_N$ ,
- ii.  $\lambda_N \subseteq \text{FN}\alpha^m\text{Cl}(\lambda_N)$ ,
- iii. If  $\lambda_N \subseteq \beta_N$ , then  $\text{FN}\alpha^m\text{Cl}(\lambda_N) \subseteq \text{FN}\alpha^m\text{Cl}(\beta_N)$ ,
- iv.  $\lambda_N$  be  $\text{FN}\alpha^m$ -closed set iff  $\lambda_N = \text{FN}\alpha^m\text{Cl}(\lambda_N)$ ,
- v.  $\text{FN}\alpha^m\text{Cl}(\lambda_N) = \text{FN}\alpha^m\text{Cl}(\text{FN}\alpha^m\text{Cl}(\lambda_N))$ .

**Proof:**

- i. by **Definition 3.11 (i)** we get,

$$\text{FN}\alpha^m\text{Cl}(\underline{0}_N) = \cap \{ \beta_N : \beta_N \text{ is } \text{FN}\alpha^m\text{-closed set in } X \text{ and } \underline{0}_N \subseteq \beta_N \} = \underline{0}_N.$$

And,

$$\text{FN}\alpha^m\text{Cl}(\underline{1}_N) = \cap \{ \beta_N : \beta_N \text{ is } \text{FN}\alpha^m\text{-closed set in } X \text{ and } \underline{1}_N \subseteq \beta_N \} = \underline{1}_N.$$

- ii.  $\lambda_N \subseteq \cap \{ \beta_N : \beta_N \text{ is } \text{FN}\alpha^m\text{-closed set in } X \text{ and } \lambda_N \subseteq \beta_N \} = \text{FN}\alpha^m\text{Cl}(\lambda_N)$ .

- iii. Suppose that  $\lambda_N \subseteq \beta_N$  then,

$$\cap \{ \beta_N : \beta_N \text{ is } \text{FN}\alpha^m\text{-closed set in } X \text{ and } \lambda_N \subseteq \beta_N \} \subseteq \cap \{ \eta_N : \eta_N \text{ is } \text{FN}\alpha^m\text{-closed set in } X \text{ and } \beta_N \subseteq \eta_N \}.$$

Therefore,  $\text{FN}\alpha^m\text{Cl}(\lambda_N) \subseteq \text{FN}\alpha^m\text{Cl}(\beta_N)$ .

- iv. If,  $\lambda_N$  be  $\text{FN}\alpha^m$ -closed set, then

$$\text{FN}\alpha^m\text{Cl}(\lambda_N) = \cap \{ \beta_N : \beta_N \text{ is } \text{FN}\alpha^m\text{-closed set in } X \text{ and } \lambda_N \subseteq \beta_N \} \dots\dots (1)$$

And, by **(ii)** we get,  $\lambda_N \subseteq \text{FN}\alpha^m\text{Cl}(\lambda_N) \dots\dots (2)$  but,  $\lambda_N$  is necessarily to be the smallest set.

Thus,  $\lambda_N = \cap \{ \beta_N : \beta_N \text{ is } \text{FN}\alpha^m\text{-closed set in } X \text{ and } \lambda_N \subseteq \beta_N \}$ ,

Therefore,  $\lambda_N = \text{FN}\alpha^m\text{Cl}(\lambda_N)$ .

**Conversely;** Let  $\lambda_N = \text{FN}\alpha^m\text{Cl}(\lambda_N)$  by using **Definition 3.11 (i)**, we get,  $\lambda_N$  be  $\text{FN}\alpha^m$ -closed set.

- v. Since, by **(iv)** we get,  $\lambda_N = \text{FN}\alpha^m\text{Cl}(\lambda_N)$   
Then,  $\text{FN}\alpha^m\text{Cl}(\lambda_N) = \text{FN}\alpha^m\text{Cl}(\text{FN}\alpha^m\text{Cl}(\lambda_N))$ .

**Proposition 3.13:** Let  $(X, \tau_N)$  be FNTS and  $\lambda_N, \beta_N$  are FNSs in  $X$ . Then the following properties hold:

- i.  $\text{FN}\alpha^m\text{Int}(\underline{0}_N) = \underline{0}_N$  and  $\text{FN}\alpha^m\text{Int}(\underline{1}_N) = \underline{1}_N$ ,
- ii.  $\text{FN}\alpha^m\text{Int}(\lambda_N) \subseteq \lambda_N$ ,
- iii. If  $\lambda_N \subseteq \beta_N$ , then  $\text{FN}\alpha^m\text{Int}(\lambda_N) \subseteq \text{FN}\alpha^m\text{Int}(\beta_N)$ ,
- iv.  $\lambda_N$  be  $\text{FN}\alpha^m$ -open set iff  $\lambda_N = \text{FN}\alpha^m\text{Int}(\lambda_N)$ ,

v.  $FN\alpha^m Int(\lambda_N) = FN\alpha^m Int(FN\alpha^m Int(\lambda_N)).$

**Proof:**

i. by **Definition 3.11 (ii)** we get,

$$FN\alpha^m Int(\underline{0}_N) = \cup \{ \beta_N: \beta_N \text{ is } FN\alpha^m\text{-open set in } X \text{ and } \beta_N \subseteq \underline{0}_N \} = \underline{0}_N,$$

And,  $FN\alpha^m Int(\underline{1}_N) = \cup \{ \beta_N: \beta_N \text{ is } FN\alpha^m\text{-open set in } X \text{ and } \beta_N \subseteq \underline{1}_N \} = \underline{1}_N.$

ii. Follows from **Definition 3.11 (ii)**.

iii.  $FN\alpha^m Int(\lambda_N) = \cup \{ \beta_N: \beta_N \text{ is } FN\alpha^m\text{-open set in } X \text{ and } \beta_N \subseteq \lambda_N \}$ . Since,  $\lambda_N \subseteq \beta_N$  then,

$$\cup \{ \beta_N: \beta_N \text{ is } FN\alpha^m\text{-open set in } X \text{ and } \beta_N \subseteq \lambda_N \} \subseteq \cup \{ \eta_N: \eta_N \text{ is } FN\alpha^m\text{-open set in } X \text{ and } \eta_N \subseteq \beta_N \}$$

Therefore,  $FN\alpha^m Int(\lambda_N) \subseteq FN\alpha^m Int(\beta_N).$

iv. We must proof that,  $FN\alpha^m Int(\lambda_N) \subseteq \lambda_N$  and  $\lambda_N \subseteq FN\alpha^m Int(\lambda_N).$

Suppose that  $\lambda_N$  be  $FN\alpha^m$ -open set in X.

Then,  $FN\alpha^m Int(\lambda_N) = \cup \{ \beta_N: \beta_N \text{ is } FN\alpha^m\text{-open set in } X \text{ and } \beta_N \subseteq \lambda_N \}.$

by using **(ii)** we get,  $FN\alpha^m Int(\lambda_N) \subseteq \lambda_N \dots (1)$

Now to proof,  $\lambda_N \subseteq FN\alpha^m Int(\lambda_N)$ , we have, For all  $\lambda_N \subseteq \lambda_N$ , the  $FN\alpha^m Int(\lambda_N) \subseteq \lambda_N$

So, we get  $\lambda_N \subseteq \cup \{ \beta_N: \beta_N \text{ is } FN\alpha^m\text{-open set in } X \text{ and } \beta_N \subseteq \lambda_N \} = FN\alpha^m Int(\lambda_N) \dots (2)$

From (1) and (2) we have,  $\lambda_N = FN\alpha^m Int(\lambda_N).$

**Conversely;** assume that  $\lambda_N = FN\alpha^m Int(\lambda_N)$  and by using **Definition 3.11 (ii)** we get,  $\lambda_N$  be  $FN\alpha^m$ -open set in X.

v. By **(iv)** we get,  $\lambda_N = FN\alpha^m Int(\lambda_N)$

Then,  $FN\alpha^m Int(\lambda_N) = FN\alpha^m Int(FN\alpha^m Int(\lambda_N)).$

**Proposition 3.14:** Let  $(X, \tau_N)$  be FNTS. Then, for any

fuzzy neutrosophic subsets  $\lambda_N$  of X.

i.  $\underline{1}_N\text{-}(FN\alpha^m Int(\lambda_N)) = FN\alpha^m Cl(\underline{1}_N\text{-}\lambda_N),$

ii.  $\underline{1}_N\text{-}(FN\alpha^m Cl(\lambda_N)) = FN\alpha^m Int(\underline{1}_N\text{-}\lambda_N).$

**Proof:**

i.  $FN\alpha^m Int(\lambda_N) = \cup \{ \beta_N: \beta_N \text{ is } FN\alpha^m\text{-open set in } X \text{ and } \beta_N \subseteq \lambda_N \}$ , by the complement we get,

$$\underline{1}_N\text{-}(FN\alpha^m Int(\lambda_N)) = \underline{1}_N\text{-}(\cup \{ \beta_N: \beta_N \text{ is } FN\alpha^m\text{-open set in } X \text{ and } \beta_N \subseteq \lambda_N \}).$$

So,  $\underline{1}_N\text{-}(FN\alpha^m Int(\lambda_N)) = \cap \{ (\underline{1}_N\text{-}\beta_N):$

$$(\underline{1}_N\text{-}\beta_N) \text{ is } FN\alpha^m\text{-closed set in } X \text{ and } (\underline{1}_N\text{-}\lambda_N) \subseteq (\underline{1}_N\text{-}\beta_N) \}.$$

Now, replacing  $(\underline{1}_N\text{-}\beta_N)$  by  $\eta_N$  we get,

$$\underline{1}_N\text{-}(FN\alpha^m Int(\lambda_N)) = \cap \{ \eta_N: \eta_N \text{ is } FN\alpha^m\text{-closed set in } X \text{ and } (\underline{1}_N\text{-}\lambda_N) \subseteq \eta_N \} = FN\alpha^m Cl(\underline{1}_N\text{-}\lambda_N).$$

ii.  $FN\alpha^m Cl(\lambda_N) = \cap \{ \beta_N: \beta_N \text{ is } FN\alpha^m\text{-closed set in } X \text{ and } \lambda_N \subseteq \beta_N \}$ , by the complement we get,

$$\underline{1}_N\text{-}(FN\alpha^m Cl(\lambda_N)) = \underline{1}_N\text{-}(\cap \{ \beta_N: \beta_N \text{ is } FN\alpha^m\text{-closed set in } X \text{ and } \lambda_N \subseteq \beta_N \}).$$

So,  $\underline{1}_N\text{-}(FN\alpha^m Cl(\lambda_N)) = \cup \{ (\underline{1}_N\text{-}\beta_N): (\underline{1}_N\text{-}\beta_N) \text{ is } FN\alpha^m\text{-open set in } X \text{ and}$

$$(\underline{1}_N\text{-}\beta_N) \subseteq (\underline{1}_N\text{-}\lambda_N) \}.$$

Again replacing  $(\underline{1}_N\text{-}\beta_N)$  by  $\eta_N$  we get,

$$\underline{1}_N\text{-}(FN\alpha^m Cl(\lambda_N)) = \cup \{ \eta_N: \eta_N \text{ is } FN\alpha^m\text{-open set in } X \text{ and } \eta_N \subseteq (\underline{1}_N\text{-}\lambda_N) \} = FN\alpha^m int(\underline{1}_N\text{-}\lambda_N).$$

**Proposition 3.15:** Fuzzy neutrosophic interior of  $F_N$ -closed set be  $FN\alpha^m$ -closed set.



**proof:** Let  $\lambda_N = \{ \langle x, \mu_{\lambda_N}(x), \sigma_{\lambda_N}(x), \nu_{\lambda_N}(x) \rangle : x \in X \}$  be  $F_N$ -closed set in FNTS  $(X, \tau_N)$ . Then, by **Definition 2.6**

(i) we get,  $\lambda_N = FNCl(\lambda_N)$ . So,  $FNInt(\lambda_N) = FNInt(FNCl(\lambda_N)) \dots (1)$ ,

And, by **Proposition 2.7 (i)** we get,

$$FNInt(\lambda_N) \subseteq \lambda_N \dots (2)$$

From (1) and (2) we get,  $FNInt(FNCl(\lambda_N)) \subseteq \lambda_N$

Now, let  $\beta_N$  be  $F_N$ -open set such that,  $\lambda_N \subseteq \beta_N$ .

Since,  $\beta_N$  be  $F_N$ -open set, then  $\beta_N$  is  $FN\alpha$ -open set by **Proposition 3.2 (i)**

Therefore,  $FNInt(FNCl(\lambda_N)) \subseteq \beta_N$ . Hence,  $\lambda_N$  be  $FN\alpha^m$ -closed set in  $(X, \tau_N)$ .

**Remark 3.16:** The relationship between different sets in FNTS can be showing in the next diagram and the converse is not true in general.

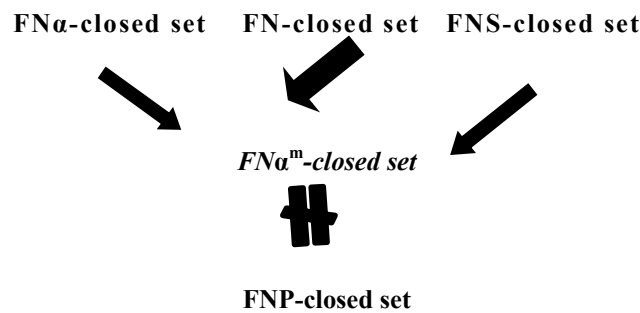

**Diagram 1**

## Conclusion

In this paper, the new concept of a new class of sets and called them fuzzy neutrosophic  $\alpha^m$ -closed sets. we investigated the relation between fuzzy neutrosophic  $\alpha^m$ -closed sets, fuzzy neutrosophic  $\alpha$  closed sets, fuzzy neutrosophic closed sets, fuzzy neutrosophic semi closed sets and fuzzy neutrosophic pre closed sets with some properties.

## References

- [1] I. Arockiarani and J.Martina Jency: More on Fuzzy Neutrosophic Sets and Fuzzy Neutrosophic Topological Spaces, IJIRS, vol. 3, 2014, pp. 642-652.
- [2] I. Arockiarani, R. Dhavaseelan, S. Jafari and M. Parimala: On Some Notions and Functions in Neutrosophic Topological Spaces, Neutrosophic Sets and System, vol. 16, 2017, pp. 16-19.
- [3] K. Atanassov and S. Stoeva, Intuitionistic Fuzzy Sets, in: Polish Syrup. On Interval & Fuzzy Mathematics, Poznan, 1983, pp. 23-26.
- [4] K. Atanassov, Intuitionistic Fuzzy Sets, Fuzzy Sets and Systems, vol. 20, 1986), pp. 87-96.
- [5] K. Atanassov: Review and New Results on Intuitionistic Fuzzy Sets, Preprint IM- MFAIS, Sofia, 1988, pp. 1-88.
- [6] Fatimah M. Mohammed, Sanna I. Abdullah and Safa, H. Obaid: (p,q)-Fuzzy  $\alpha^m$ -Closed Sets in Double Fuzzy Topological Spaces, Diyala ournal for Pure Sciences, vol 14, Iss.1, 2018, pp.109-127.
- [7] Floretin Smaradache, Neutrosophic Set: A Generalization of Intuitionistic Fuzzy Set, Journal of Defense Resources Management, vol. 1, 2010, pp. 1-10.
- [8] A. A. Salama and S. A. Alblowi: Neutrosophic Set and Neutrosophic Topological Spaces, IOSR Journal of Mathematics, ISSN:2278-5728, Vol. 3, Iss. 4, 2012, pp. 31-35.

- [9] A. A. Salama: Basic Structure of Some Classes of Neutrosophic Crisp Nearly Open Sets & Possible Application to GIS Topology, *Neutrosophic Sets and Systems*, vol. 7, 2015, pp. 18-22.
- [10] A.A. Salama, Florentin Smarandache, S. A. Alblowi: The Characteristic Function of a Neutrosophic Set, *Neutrosophic Sets and Systems*, vol. 3, 2014, pp. 14-17.
- [11] A.A. Salama, Florentin Smarandache, Valeri Kromov: Neutrosophic Closed Set and Neutrosophic Continuous Functions, *Neutrosophic Sets and Systems*, vol. 4, 2014, pp. 4-8.
- [12] A. A. Salama, Florentin Smarandache: Neutrosophic Crisp Set Theory, *Neutrosophic Sets and Systems*, vol. 5, 2014, pp. 27-35.
- [13] Y. Veereswari: An Introduction To Fuzzy Neutrosophic Topological Spaces, *IJMA*, Vol.8(3), (2017), 144-149.
- [14] L. Zadeh, *Fuzzy Sets*, *Inform. and Control*, vol.8, 1965, pp.338-353.
- [15] Abdel-Basset, M., Manogaran, G., Gamal, A., & Smarandache, F. (2018). A hybrid approach of neutrosophic sets and DEMATEL method for developing supplier selection criteria. *Design Automation for Embedded Systems*, 1- 22.
- [16] Abdel-Basset, M., Mohamed, M., & Chang, V. (2018). NMCDA: A framework for evaluating cloud computing services. *Future Generation Computer Systems*, 86, 12-29.
- [17] Abdel-Basset, M., Mohamed, M., Zhou, Y., & Hezam, I. (2017). Multi-criteria group decision making based on neutrosophic analytic hierarchy process. *Journal of Intelligent & Fuzzy Systems*, 33(6), 4055-4066.
- [18] Abdel-Basset, M.; Mohamed, M.; Smarandache, F. An Extension of Neutrosophic AHP–SWOT Analysis for Strategic Planning and Decision-Making. *Symmetry* 2018, 10, 116.
- [19] Abdel-Basset, Mohamed, et al. "A novel group decision-making model based on triangular neutrosophic numbers." *Soft Computing* (2017): 1-15. DOI: <https://doi.org/10.1007/s00500-017-2758-5>
- [20] Abdel-Basset, Mohamed, Ibrahim M. Hezam, and Florentin Smarandache. "Neutrosophic goal programming." *Neutrosophic Sets Syst* 11 (2016): 112-118.
- [21] El-Hefenawy, Nancy, et al. "A review on the applications of neutrosophic sets." *Journal of Computational and Theoretical Nanoscience* 13.1 (2016): 936-944.
- [22] Arindam Dey, Said Broumi, Le Hoang Son, Assia Bakali, Mohamed Talea, Florentin Smarandache, "A new algorithm for finding minimum spanning trees with undirected neutrosophic graphs", *Granular Computing* (Springer), pp.1-7, 2018

Received: July 3, 2018. Accepted: August 2, 2018.



# Neutrosophic Crisp Bi-Topological Spaces

Riad Khidr Al-Hamido

Faculty of Science, Department of Mathematics, Al-Baath University, Homs, Syria. E-mail: riad-hamido1983@hotmail.com

**Abstract.** In this paper, neutrosophic crisp bi-topological spaces, new types of open and closed sets in neutrosophic crisp bi-topological spaces, the closure and interior neutrosophic crisp set and a new concept of open and closed sets are introduced. The basic properties of these types of open and closed sets and their properties are studied.

**Keywords:** Neutrosophic crisp bi-topological spaces, neutrosophic crisp bi-open set, neutrosophic crisp bi-closed set, neutrosophic crisp S-open sets and neutrosophic crisp S-closed.

## 1. Introduction

Smarandache [1, 2] proposed a new branch of philosophy, called “Neutrosophy”. From neutrosophy, Smarandache [1, 2, 3, 4] defined neutrosophic set. Neutrosophic set consists of three independent components  $T$ ,  $I$ , and  $F$  which represent the membership, indeterminacy, and non membership values respectively.  $T$ ,  $I$ , and  $F$  assumes the values from the non-standard unit interval  $]0,1^+[$ . Smarandache [1, 2] made the foundation of neutrosophic logic which generalizes fuzzy logic [5] and intuitionistic fuzzy logic [6]. Salama, Smarandache proposed the Neutrosophic Crisp Set Theory [16].

Alblowi, Salama and M. Eisa [7, 8] defined studied on neutrosophic sets and defined normal neutrosophic set, convex set, the concept of  $\alpha$ -cut and neutrosophic ideals. Hanafy, Salama and Mahfouz [9] considered some possible definitions for basic concepts of the Neutrosophic Crisp Data And Its Operations.

Salama and Alblowi [10] defined neutrosophic topological spaces and established some of its properties. Salama and Alblowi [11] defined generalized neutrosophic set and defined generalized neutrosophic topological spaces. In the same study, Salama and Alblowi [11] established some properties of generalized neutrosophic topological spaces. Salama and Elagamy [12] introduced the notion of filters on neutrosophic sets and studied several relations between different neutrosophic filters and neutrosophic topologies. Salama and Smarandache [13] studied several relations between different neutrosophic crisp filters and neutrosophic topologies.

Salama, Smarandache and Kroumov [14] generalized the crisp topological spaces to the notion of neutrosophic crisp topological space. In the same study, Salama, Smarandache and Kroumov [14] introduced the definitions of neutrosophic crisp continuous function and neutrosophic crisp compact spaces.

In this paper we introduce the concept of neutrosophic crisp bi-topological spaces as generalization of neutrosophic crisp topological spaces. We introduce few new types of open and closed sets as neutrosophic crisp bi-open sets, neutrosophic crisp bi-closed sets, neutrosophic

crisp S-open sets and neutrosophic crisp S-closed sets. We investigate the properties of these new four types of neutrosophic crisp sets.

Rest of the paper is organized as follows: Section 2 presents preliminaries of neutrosophic crisp set, neutrosophic crisp topology. Section 3 presents Neutrosophic crisp bi-topological spaces. Section 4 devotes the closure and the interior via neutrosophic crisp bi-open sets (Bi-NCOS) and neutrosophic crisp bi-closed (Bi-NCCS). Section 5 devotes the neutrosophic crisp S-open sets (S-NCOS) and neutrosophic crisp S-closed sets (S-NCOS). Section r presents conclusion of the paper.

## 2. Preliminaries Of Neutrosophic Crisp Sets:

**Definition 2.1.** [14] Let  $X$  be a non-empty fixed set. A neutrosophic crisp set (NCS)  $A$  is an object having the form  $A = \{A_1, A_2, A_3\}$ , where  $A_1, A_2$  and  $A_3$  are subsets of  $X$  satisfying  $A_1 \cap A_2 = \phi$ ,  $A_1 \cap A_3 = \phi$  and  $A_2 \cap A_3 = \phi$ .

**Definition 2.2.** [14, 15] Types of NCSs  $\phi_N$  and  $X_N$  in  $X$

1.  $\phi_N$  may be defined in many ways as a NCS as follows:
  1.  $\phi_N = (\phi, \phi, X)$  or
  2.  $\phi_N = (\phi, X, X)$  or
  3.  $\phi_N = (\phi, X, \phi)$  or
  4.  $\phi_N = (\phi, \phi, \phi)$ .
2.  $X_N$  may be defined in many ways as a NCS, as follows:
  1.  $X_N = (X, \phi, \phi)$  or
  2.  $X_N = (X, X, \phi)$  or
  3.  $X_N = (X, X, X)$ .

**Definition 2.3.** [14] A neutrosophic set  $A$  is a subset of a neutrosophic set  $B$  denoted by  $A \subseteq B$ , may be defined as:

1.  $A \subseteq B \Leftrightarrow A_1 \subseteq B_1, A_2 \subseteq B_2$  and  $B_3 \subseteq A_3$ .
2.  $A \subseteq B \Leftrightarrow A_1 \subseteq B_1, B_2 \subseteq A_2$  and  $B_3 \subseteq A_3$ .

**Definition 2.4.** [14] Let  $X$  be a non-empty set, and the NCSs  $A$  and  $B$  in the form  $A = \{A_1, A_2, A_3\}$ ,  $B = \{B_1, B_2, B_3\}$ . Then:

1.  $A \cap B$  may be defined in two ways:
  - i)  $A \cap B = (A_1 \cap B_1, A_2 \cap B_2, A_3 \cup B_3)$
  - ii)  $A \cap B = (A_1 \cap B_1, A_2 \cup B_2, A_3 \cup B_3)$ .
2.  $A \cup B$  may be defined in two ways as a NCSs.
  - i)  $A \cup B = (A_1 \cup B_1, A_2 \cap B_2, A_3 \cap B_3)$
  - ii)  $A \cup B = (A_1 \cup B_1, A_2 \cup B_2, A_3 \cap B_3)$ .

**Definition 2.5.** [14] A neutrosophic crisp topology (NCT) on a non-empty set  $X$  is a fami-

ly  $\Gamma$  of neutrosophic crisp subsets in  $X$  satisfying the following axioms:

1.  $\phi_N, X_N \in \Gamma$ .
2.  $A_1 \cap A_2 \in \Gamma$ , for any  $A_1$  and  $A_2 \in \Gamma$ .
3.  $\cup A_j \in \Gamma, \forall \{A_j : j \in J\} \subseteq \Gamma$ .

The pair  $(X, \Gamma)$  is said to be a neutrosophic crisp topological space (NCTS) in  $X$ , a set of elements in  $\Gamma$  is said to be a neutrosophic crisp open set (NCOS), neutrosophic crisp set  $F$  is closed (NCCS) if and only if its complement  $F^c$  is an open neutrosophic crisp set.

**Definition 2.6.** [14] Let  $X$  be a non-empty set, and the NCS  $A$  in the form  $A = \{A_1, A_2, A_3\}$ .

Then  $A^c$  may be defined in three ways as an NCS, as follows:

- i)  $A^c = \langle A_1^c, A_2^c, A_3^c \rangle$  or
- ii)  $A^c = \langle A_3, A_2, A_1 \rangle$  or
- iii)  $A^c = \langle A_3, A_2^c, A_1 \rangle$ .

### 3. Neutrosophic Crisp Bi-Topological Space

In this section, we introduce neutrosophic bi-topological crisp spaces. Moreover we introduce new types of open and closed sets in neutrosophic bi-topological crisp spaces.

**Definition 3.1.** Let  $\Gamma_1, \Gamma_2$  be any two neutrosophic crisp topology (NCT) on a nonempty set  $X$ . Then  $(X, \Gamma_1, \Gamma_2)$  is a neutrosophic crisp bi-topological space (Bi-NCTS for short).

**Example 3.1.** Let  $X = \{1, 2, 3, 4\}$ ,

$$\Gamma_1 = \{\phi_N, X_N, D, C\}, \Gamma_2 = \{\phi_N, X_N, A, B\},$$

$$A = \langle \{1\}, \{2, 4\}, \{3\} \rangle = C, B = \langle \{1\}, \{2\}, \{2, 3\} \rangle, D = \langle \{1\}, \{2\}, \{3\} \rangle.$$

Then  $(X, \Gamma_1), (X, \Gamma_2)$  are two neutrosophic crisp spaces. Therefore  $(X, \Gamma_1, \Gamma_2)$  is a neutrosophic crisp bi-topological space (Bi-NCTS).

**Definition 3.2.** Let  $(X, \Gamma_1, \Gamma_2)$  be a neutrosophic crisp Bi-topological space (Bi-NCTS).

The elements in  $\Gamma_1 \cup \Gamma_2$  are said to be neutrosophic crisp bi-open sets (Bi-NCOS for short). A neutrosophic crisp set  $F$  is closed (Bi-NCCS for short) if and only if its complement  $F^c$  is an neutrosophic crisp bi-open set.

- the family of all neutrosophic crisp bi-open sets is denoted by  $(\text{Bi-NCOS}(X))$ .

- the family of all neutrosophic crisp bi-closed sets is denoted by  $(\text{Bi-NCCS}(X))$ .

**Example 3.2.** In Example 3.1, the neutrosophic crisp bi-open sets (Bi-NCOS) are :

$$\text{Bi-NCOS}(X) = \Gamma_1 \cup \Gamma_2 = \{\phi_N, X_N, A, B, C, D\}$$

the neutrosophic crisp bi-closed sets (Bi-NCCS) are :

$$\text{Bi-NCCS}(X) = \Gamma_1 \cup \Gamma_2 = \{\phi_N, X_N, A_1, B_1, C_1, D_1\} \text{ where: } A_1 = \langle \{2, 3, 4\}, \{1, 3\}, \{1, 2, 4\} \rangle = C_1,$$

$$B_1 = \langle \{2, 3, 4\}, \{1, 3, 4\}, \{1, 2\} \rangle,$$

$$D_1 = \langle \{2, 3, 4\}, \{1, 3, 4\}, \{1, 2, 4\} \rangle$$

**Remark 3.1.**

- 1) Every neutrosophic crisp open set in  $(X, \Gamma_1)$  or  $(X, \Gamma_2)$  is a neutrosophic crisp bi-open set.
- 2) Every neutrosophic crisp closed set in  $(X, \Gamma_1)$  or  $(X, \Gamma_2)$  is a neutrosophic crisp bi-closed set.

**Remark 3.2.**

Every neutrosophic crisp bi-topological space  $(X, \Gamma_1, \Gamma_2)$  induces two neutrosophic crisp topological spaces as  $(X, \Gamma_1), (X, \Gamma_2)$ .

**Remark 3.3.**

If  $(X, \Gamma)$  be a neutrosophic crisp topological space then  $(X, \Gamma, \Gamma)$  is a neutrosophic crisp Bi-topological space.

**Theorem 3.1.** Let  $(X, \Gamma_1, \Gamma_2)$  be a neutrosophic crisp bi-topological space (Bi-NCTS). Then, the union of two neutrosophic crisp bi-open (bi-closed) sets is not a neutrosophic crisp bi-open (bi-closed) set.

The proof of the theorem 3.1 follows from the example 3.3.

**Example 3.3.**

$$X = \{1, 2, 3, 4\}, \Gamma_1 = \{\phi_N, X_N, D, C\}, \Gamma_2 = \{\phi_N, X_N, A, B\}, \\ A = \langle \{3\}, \{2, 4\}, \{1\} \rangle, D = \langle \{1\}, \{2\}, \{3\} \rangle, C = \langle \{1\}, \{2, 4\}, \{3\} \rangle$$

It is clear that  $(X, \Gamma_1), (X, \Gamma_2)$  are neutrosophic crisp topological spaces. Therefore  $(X, \Gamma_1, \Gamma_2)$  is a neutrosophic crisp bi-topological space

$A, D$  are two neutrosophic crisp bi-open sets but  $A \cup D = \langle \{1, 3\}, \{2, 4\}, \phi \rangle$  is not neutrosophic crisp bi-open set.  $A^c = \langle \{1, 2, 4\}, \{1, 3\}, \{2, 3, 4\} \rangle, D^c = \langle \{2, 3, 4\}, \{1, 3, 4\}, \{1, 2, 4\} \rangle$

are two neutrosophic crisp bi-closed sets but  $A^c \cup D^c = \langle X, \{1, 3\}, \{2, 4\} \rangle$  is not a neutrosophic crisp bi-closed set.

**Theorem 3.2.** Let  $(X, \Gamma_1, \Gamma_2)$  be a neutrosophic crisp bi-topological space (Bi-NCTS). Then, the intersection of two neutrosophic crisp bi-open (bi-closed) sets is a neutrosophic crisp bi-open (bi-closed) set.

The proof of the theorem 3.2 follows from the example 3.4

**Example 3.4.** In example 3.3,  $A, D$  are two neutrosophic crisp bi-open sets but  $A \cap D = \langle \emptyset, \{2\}, \{1, 3\} \rangle$  is not a neutrosophic crisp bi-open set.

$$A^c = \langle \{1, 2, 4\}, \{1, 3\}, \{2, 3, 4\} \rangle,$$

$D^c = \langle \{2, 3, 4\}, \{1, 3, 4\}, \{1, 2, 4\} \rangle$ , are two neutrosophic crisp bi-closed sets but  $A^c \cap D^c = \langle \{2, 4\}, \{1, 3\}, X \rangle$  is not a neutrosophic crisp bi-closed set.

#### 4. The closure and the interior via neutrosophic crisp bi-open sets (Bi-NCOS) and neutrosophic crisp bi-closed (Bi-NCCS)

In this section, we use this new concept of open and closed sets in the definition of closure and interior neutrosophic crisp set, where we define the closure and interior neutrosophic crisp set based on these new varieties of open and closed neutrosophic crisp sets. Also we introduce the basic properties of closure and the interior.

**Definition 4. 1.** Let  $(X, \Gamma_1, \Gamma_2)$  be a neutrosophic crisp bi-topological space (Bi-NCTS) and A is a neutrosophic crisp set. Then, the union of neutrosophic crisp bi-open sets containing A is called neutrosophic crisp bi-interior of A ( $NC^{Bi}Int(A)$  for short).

$$NC^{Bi}Int(A) = \cup \{B : B \subseteq A ; B \text{ is neutrosophic crisp bi-open set}\}.$$

**Theorem 4.1.** Let  $(X, \Gamma_1, \Gamma_2)$  be neutrosophic crisp bi-topological space (Bi-NCTS), A is neutrosophic crisp set then:

1.  $NC^{Bi}Int(A) \subseteq A$ .
2.  $NC^{Bi}Int(A)$  is not neutrosophic crisp bi-open set .

**Proof :**

1. It follows from the definition of  $NC^{Bi}Int(A)$  as a union of *neutrosophic crisp bi-open sets* contains A.
2. Follow from Theorem 3.2.

**Theorem 4.2.** Let  $(X, \Gamma_1, \Gamma_2)$  be a neutrosophic crisp bi-topological space (Bi-NCTS), A and B are neutrosophic crisp sets. Then,

$$A \subseteq B \Rightarrow NC^{Bi}Int(A) \subseteq NC^{Bi}Int(B) .$$

**Proof:** The Proof is obvious.

**Definition 4.2.** Let  $(X, \Gamma_1, \Gamma_2)$  be a neutrosophic crisp bi-topological space (Bi-NCTS), A is neutrosophic crisp set. Then, the intersection of neutrosophic crisp bi-open sets, contained A is called neutrosophic crisp Bi-closure of A ( $NC^{Bi}Cl(A)$  for short).

$$NC^{Bi}Cl(A) = \cap \{B : B \supseteq A ; B \text{ is a neutrosophic bi-closed set}\}.$$

**Theorem 4. 3.** Let  $(X, \Gamma_1, \Gamma_2)$  be a neutrosophic crisp bi-topological space (Bi-NCTS), and A is neutrosophic crisp set. Then

1.  $A \subseteq NC^{Bi}cl(A)$  .
2.  $NC^{Bi}cl(A)$  is not a neutrosophic crisp bi-closed set.

**Proof :**

1. It follow from the definition of  $NC^{Bi}cl(A)$  as an intersection of neutrosophic crisp bi-closed sets, contained in A.
2. It follows from the Theorem 3.2.

### 5. The neutrosophic crisp S-open sets (S-NCOS) and neutrosophic crisp S-closed sets (S-NCCS):

We introduce new concept of open and closed sets in neutrosophic crisp bi-topological space in this section, as neutrosophic crisp S-open sets (S-NCOS) and neutrosophic crisp S-closed sets (S-NCCS). Also we introduce the basic properties of this new concept of open and closed sets in bi-NCTS, and their relationship with neutrosophic crisp bi-open sets and neutrosophic crisp bi-closed sets.

**Definition 5.1.** Let  $(X, \Gamma_1, \Gamma_2)$  be a neutrosophic crisp bi-topological space (Bi-NCTS). Then, a subset  $A$  of space  $X$  is said to be a neutrosophic crisp S-open set (S-NCOS for short ) if  $A \in \Gamma_1$  and  $A \notin \Gamma_2$  or  $A \in \Gamma_2$  and  $A \notin \Gamma_1$  and its complement is said to be neutrosophic crisp S-closed set (S-NCCS for short ).

\* the family of all neutrosophic crisp S-open sets is denoted by ( S-NCOS(X) ).

\* the family of all neutrosophic crisp S-closed sets is denoted by ( S-NCCS(X) ).

**Example 5.1.** In Example 3.1,  $B, D$  are two neutrosophic crisp S-open sets.

**Theorem 5.1** Let  $(X, \Gamma_1, \Gamma_2)$  be a neutrosophic crisp bi-topological space (Bi-NCTS), then

1. Every S-NCOS is Bi-NCOS.
2. Every S-NCCS is Bi-NCCS.

**Proof:**

1. Let  $A$  be neutrosophic crisp S-open set ,then  $A \in \Gamma_1$  and  $A \notin \Gamma_2$  or  $A \in \Gamma_2$  and  $A \notin \Gamma_1$  therefore  $A$  is Bi-NCOS.
2. Let  $A$  be neutrosophic crisp S-closed set,then  $A^c$  is neutrosophic crisp S-open set therefore  $A^c \in \Gamma_1$  and  $A^c \notin \Gamma_2$  or  $A^c \in \Gamma_2$  and  $A^c \notin \Gamma_1$  , so  $A^c$  is Bi-NCOS therefore  $A$  is a Bi-NCCS .

**Remark 5.1.** The converse of Theorem 5.1 is not true. It is shown in example 5.2.

**Example 5.2.** In any neutrosophic crisp bi-topo-logical space,  $\phi_N, X_N$  are two neutrosophic crisp bi-open sets, but  $\phi_N, X_N$  are not neutrosophic crisp bi-open sets.

Also  $\phi_N, X_N$  are two neutrosophic crisp bi-closed sets, but  $\phi_N, X_N$  are not neutrosophic crisp bi-closed sets.

**Theorem 5.2.** Let  $(X, \Gamma_1, \Gamma_2)$  be a neutrosophic crisp bi-topological space (Bi-NCTS). Then, the union of two neutrosophic crisp S-open (S-closed) sets is not a neutrosophic crisp S-open (S-closed) set.

Proof. The proof follows from the following example 5.3.



**Example 5.3.** In example 3.4

$$X = \{1, 2, 3, 4\}, \Gamma_1 = \{\phi_N, X_N, A\},$$

$$\Gamma_2 = \{\phi_N, X_N, D, C\}, A = \langle \{3\}, \{2, 4\}, \{1\} \rangle.$$

$$D = \langle \{1\}, \{2\}, \{3\} \rangle, C = \langle \{1\}, \{2, 4\}, \{3\} \rangle.$$

It is clear that  $(X, \Gamma_1), (X, \Gamma_2)$  are neutrosophic crisp topological spaces, therefore  $(X, \Gamma_1, \Gamma_2)$  is a neutrosophic crisp bi-topological space.

$A, D$  are two neutrosophic crisp S-open sets but  $A \cup D = \langle \{1, 3\}, \{2, 4\}, \emptyset \rangle$  is not a neutrosophic crisp S-open set.

$A^c = \langle \{1, 2, 4\}, \{1, 3\}, \{2, 3, 4\} \rangle, D^c = \langle \{2, 3, 4\}, \{1, 3, 4\}, \{1, 2, 4\} \rangle$  are two *neutrosophic crisp S-closed* sets but  $A^c \cup D^c = \langle X, \{1, 3\}, \{2, 4\} \rangle$  is not a *neutrosophic crisp S-closed* set.

**Theorem 5.3.** Let  $(X, \Gamma_1, \Gamma_2)$  be a neutrosophic crisp Bi-topological space (Bi-NCTS), then the intersection of two *neutrosophic crisp S-open* (*S-closed*) sets is *not a neutrosophic crisp S-open* (*S-closed*) set.

Proof. The proof follows from the following example 5.4.

**Example 5.4** In example 3.4,  $A, D$  are two *neutrosophic crisp S-open* sets but  $A \cap D = \langle \emptyset, \{2\}, \{1, 3\} \rangle$  is not a *neutrosophic crisp S-open* set.

$A^c = \langle \{1, 2, 4\}, \{1, 3\}, \{2, 3, 4\} \rangle, D^c = \langle \{2, 3, 4\}, \{1, 3, 4\}, \{1, 2, 4\} \rangle$  are two *neutrosophic crisp S-closed* sets but  $A^c \cap D^c = \langle \{2, 4\}, \{1, 3\}, X \rangle$  is not a *neutrosophic crisp S-closed* set.

## 6 Conclusion

In this paper we have introduced neutrosophic crisp bi-topological space, neutrosophic crisp Bi-open, neutrosophic crisp bi-closed, neutrosophic crisp S-open, neutrosophic crisp S-open set's. Also we have studied some of their basic properties and their relationship with each other. Finally, these new concepts are going to pave the way for new types of open and closed sets as neutrosophic crisp bi- $\alpha$ -open sets, neutrosophic crisp bi- $\beta$ -open sets, neutrosophic crisp bi-pre-open sets, neutrosophic crisp bi-semi-open sets.

## References

- [1] F. Smarandache. A unifying field of logics. Neutrosophy: neutrosophic probability, set and logic, American Research Press, Rehoboth, (1998).
- [2] F. Smarandache, A unifying field in logics: neutrosophic logics. Multiple valued logic, 2002, 8(3), 385-438.
- [3] F. Smarandache, Neutrosophic set- a generalization of intuitionistic fuzzy sets. International Journal of Pure and Applied Mathematics, 2005, 24(3), 287-297.
- [4] F. Smarandache, Neutrosophic set-a generalization of intuitionistic fuzzy set. Journal of Defense Resources Management, 2010, 1(1), 107-116.
- [5] L. A. Zadeh, Fuzzy sets. Information and Control, 1965, 8(3), 338-353.
- [6] K. T. Atanassov, Intuitionistic fuzzy sets. Fuzzy Sets and Systems, 1986, 20(1), 87-96.

- [7] S. A. Alblowi, A. A. Salama and M. Eisa. New concepts of neutrosophic sets. *International Journal of Mathematics and Computer Applications Research*, 2014, 4(1), 59-66.
- [8] S. A. Alblowi, A. A. Salama, and M. Eisa. New concepts of neutrosophic sets, *International Journal of Mathematics and Computer Applications Research*, 2013, 3 (4), 95-102.
- [9] I. M. Hanafy, A. A. Salama and K.M. Mahfouz. Neutrosophic crisp events and its probability. *International Journal of Mathematics and Computer Applications Research*, 2013, 3 (1), 171-178.
- [10] A. A. Salama and S. A. Alblowi. Neutrosophic set and neutrosophic topological space. *IOSR Journal of Mathematics*, 2012, 3 (4), 31-35.
- [11] A. A. Salama and S. A. Alblowi. Generalized neutrosophic set and generalized neutrosophic topological spaces, *Computer Science Engineering*, 2012, 2(7), 29-32.
- [12] A. A. Salama and H. Elagamy. Neutrosophic filters. *International Journal of Computer Science Engineering and Information Technology Research*, 2013, 3(1), 307-312.
- [13] A. A. Salama and F. Smarandache. Filters via neutrosophic crisp sets, *Neutrosophic Sets and Systems*, 2013, 1(1), 34-38.
- [14] A. A. Salama, F.Smarandache and Valeri Kroumov. Neutrosophic crisp sets and neutrosophic crisp topological spaces. *Neutrosophic Sets and Systems*, 2014, 2, 25-30.
- [15] A. A. Salama. Basic structure of some classes of neutrosophic crisp nearly open sets and possible application to GIS topology. *Neutrosophic Sets and Systems*, 2015,7, 18-22.
- [16] A. A. Salama, F.Smarandache, *Neutrosophic crisp set theory*, Educational. Education Publishing 1313 Chesapeake, Avenue, Columbus, Ohio 43212( 2015).

Received: July 11, 2018. Accepted: August 6, 2018.



# Multi-Objective Portfolio Selection Model with Diversification by Neutrosophic Optimization Technique

Sahidul Islam<sup>1</sup>, Partha Ray\*<sup>2</sup>

<sup>1</sup> Department of Mathematics, University of Kalyani, Kalyani, India. E-mail: sahidul.math@gmail.com

<sup>2</sup> Department of Mathematics, R.K.M.V.C. College, Rahara-700118, India. E-mail: picklu.ray@gmail.com

\*Corresponding author

**Abstract.** In this paper, we first consider a multi-objective Portfolio Selection model and then we add another entropy objective function and next we generalized the model. We solve the problems using Neutrosophic optimization technique. The models are illustrated with numerical examples.

**Keywords:** Portfolio Optimization, Multi-objective Model, Entropy, Neutrosophic set, Neutrosophic optimization method.

## 1. Introduction:

Markowitz [5] first introduced the theory of mean-variance efficient portfolios and also gave his critical line method for finding these. He combined probability and optimization theory. Roll [2] gave an analytical method to find modified mean-variance efficient portfolios where he allowed short sales. Single objective portfolio optimization method using fuzzy decision theory, possibilistic and interval programming are given by Wang et. al.[7]. Inuiguchi and Tanino [3] proposed a new approach to the possibilistic portfolio selection problem.

Very few authors discussed entropy based multi-objective portfolio selection method. Here entropy is acted as a measure of dispersal. The entropy maximization model has attracted a good deal of attention in urban and regional analysis as well as in other areas. Usefulness of entropy optimization models in portfolio selection based problems are illustrated in two well-known books ([4],[6]).

Zadeh [1] first introduced the concept of fuzzy set theory. Zimmermann [13] used Bellman and Zadeh's [14] fuzzy decision concept. Zimmermann applied the fuzzy set theory concept with some suitable membership functions to solve linear programming problem with several objective functions. In traditional fuzzy sets, one real value  $\mu_A(x) \in [0,1]$  represents the truth membership function of fuzzy set defined on universe of discourse  $X$ . But sometimes we have problems due to uncertainty of  $\mu_A(x)$  itself. It is very hard to find a crisp value then. To avoid the problem, the concept of interval valued fuzzy sets was proposed. In real life problem, we should consider the truth membership function supported by the evident as well as the falsity membership function against by the evident. So, Atanassov ([8],[10]) introduced the intuitionistic fuzzy sets in 1986. The intuitionistic fuzzy sets consider both truth and falsity membership functions. But it can only effective for incomplete information. Intuitionistic fuzzy sets cannot handle when we have indeterminate information and inconsistent information. In decision making theory, decision makers can make a decision, cannot make a decision or can hesitate to make a decision. We cannot use intuitionistic fuzzy sets in this situation. Then Neutrosophy was introduced by Smarandache [11] in 1995. Realising the difference between absolute truth and relative truth or between absolute falsehood and relative falsehood, Smarandache started to use non-standard analysis. Then he combined the non-standard analysis with logic, set, probability theory and philosophy. Neutrosophic theory has various fields like Neutrosophic Set, Neutrosophic Logic, Neutrosophic Probability, Neutrosophic Statistics, Neutrosophic Precalculus and Neutrosophic Calculus. In neutrosophic sets we have truth membership, indeterminacy membership and falsity membership functions which are independent. In Neutrosophic logic, a proposition has a degree of truth( $T$ ), degree of indeterminacy( $I$ ) and a degree of falsity( $F$ ), where  $T, I, F$  are standard or non-standard subsets of  $]0^-, 1^+]$ . Wang, Smarandache, Zhang and Sunderraman [12] discussed about single valued neutrosophic sets, multispace and multistructure. S. Pramanik ([15], [16]) and Abdel-Baset, Hezam & Smarandache ([18], [19]) used Neutrosophic theory in multi-objective linear programming, linear goal programming. Sahidul Islam, Tanmay Kundu [20] applied Neutrosophic optimization technique to solve multi- objective Reliability problem. M. Sarkar, T. K. Roy [17] used Neutrosophic

optimization technique in optimization of welded beam structure. Pintu Das, T.K.Roy [9] applied Neutrosophic optimization technique in Riser design problem.

Our objective in this paper is to give a computational algorithm for solving multi-objective portfolio selection problem with diversification by single valued neutrosophic optimization technique. We also take different weights on objective functions. The models are illustrated with numerical examples.

**2. Mathematical Model:**

Suppose that a prosperous individual has an opportunity to invest an asset (i.e. a fixed amount of money) in n different bonds and stocks. Let  $x = (x_1, x_2, \dots, x_n)^T$ , where  $x_j$  is the proportion of his assets invested in the j-th security. The vector x is called portfolio. Clearly, a physically realizable portfolio must satisfy  $x_j \geq 0, (j = 1, 2, \dots, n), \sum_{j=1}^n x_j = 1$ . The agents are assumed to strike balance between maximizing the return and minimizing the risk of their investment decision. Return is quantified by the mean, and risk is characterized by the variance, of a portfolio assets. The return  $R_j$  for the j-th security, ( $j = 1, 2, \dots, n$ ), is a random variable, with expected return  $r_j = E(R_j)$ . Let  $R = (R_1, R_2, \dots, R_n)^T, r = (r_1, r_2, \dots, r_n)^T$ . The return for the portfolio is thus  $R^T x = \sum_{j=1}^n R_j x_j$  and expected return  $Er(x) = E(R^T x) = \sum_{j=1}^n r_j x_j$ . Let  $(\sigma_{ij})_{n \times n}$  be the covariance matrix of a random vector R, the variance of the portfolio is  $Vr(x) = Var(R^T x) = \sum_{i=1}^n \sum_{j=1}^n \sigma_{ij} x_i x_j$  where

$$\begin{aligned} \sigma_{ii} &= \sigma_i^2, \quad i = j \\ &= \rho_{ij} \sigma_i \sigma_j, \quad i > j \text{ or } j > i. \end{aligned}$$

$\sigma_i^2$  is the variance of  $R_j$  and  $\rho_{ij}$  is the correlation coefficient between  $R_j$  and  $R_i, \forall i \text{ and } j = 1, 2, \dots, n$ .

**2.1 Portfolio Selection problem (PSP):**

The two objectives of an investor are thus to maximize the expected value of return and minimize the variance subject to a constraint of a Portfolio. So the Portfolio Selection Problem (PSP) is:

$$\begin{aligned} \text{Maximize } Er(x) &= \sum_{j=1}^n r_j x_j, \\ \text{Minimize } Vr(x) &= \sum_{i=1}^n \sum_{j=1}^n \sigma_{ij} x_i x_j, \end{aligned} \tag{2.1}$$

subject to

$$\begin{aligned} \sum_{i=1}^n x_i &= 1, \\ \text{and } x_j &\geq 0, \quad j = 1, 2, \dots, n. \end{aligned}$$

Markowitz's mean variance criterion simply states that an investor should always choose an efficient portfolio.

**2.2 Entropy:**

In physics, the word entropy has important physical implications as the amount of "disorder" of a system but in mathematics, we use more abstract definition. The (Shannon) entropy of a variable X is defined as

$$EN(X) = -\sum_{i=1}^n x_i \ln x_i, \text{ where } x_i \text{ is the probability that } X \text{ is in the state } x, \text{ and } x_i \ln x_i \text{ is defined as } 0 \text{ if } x_i = 0.$$

**2.3 Portfolio Selection problem with Diversification (PSPD):**

In real life problem, we introduce another entropy objective function in problem (2.1) which is a Portfolio Selection Problem with Diversification (PSPD) and it is written as

$$\begin{aligned} \text{Maximize } EN(X) &= -\sum_{i=1}^n x_i \ln x_i \\ \text{Maximize } Er(x) &= \sum_{j=1}^n r_j x_j, \\ \text{Minimize } Vr(x) &= \sum_{i=1}^n \sum_{j=1}^n \sigma_{ij} x_i x_j, \end{aligned} \tag{2.2}$$

subject to

$$\begin{aligned} \sum_{i=1}^n x_i &= 1, \\ \text{and } x_j &\geq 0, \quad j = 1, 2, \dots, n. \end{aligned}$$

**2.4 Generalized Portfolio Selection problem with Diversification (GPSPD):**

For generalization of the above model, an investor can construct a portfolio based on m potential market scenarios from an investment universe of n assets. Let  $R_j^k (j = 1, 2, \dots, n, k = 1, 2, \dots, m)$  denotes the return of the j-th asset and let  $R_k(x) = \sum_{j=1}^n R_j^k x_j$  denotes the portfolio return with expected return  $Er_k(x) = \sum_{j=1}^n r_j^k x_j$ , and

$$\sigma_{ii}^k = (\sigma_i^k)^2, \quad i = j$$

$$\sigma_{ii}^k = \rho_{ii}^k \sigma_i^k \sigma_i^k, \quad i > j \text{ or } j > i.$$

Where  $(\sigma_i^k)^2$  is the variance of  $R_i^k$  and  $\rho_{ii}^k$  is the correlation coefficient between  $R_i^k$  and  $R_i^k$  ( $\forall i, j = 1, 2, \dots, n$ ) for the  $k$ -th market scenario at the end of investment period, then  $Vr_k(x) = \sum_{i=1}^n \sum_{i=1}^n \sigma_{ii}^k x_i x_i$  denote the risk for the  $k$ -th scenario. So Generalized Portfolio Selection Problem with Diversification (GPSPD) can be stated as follows:

$$\begin{aligned} &\text{Maximize } EN(X) = -\sum_{i=1}^n x_i \ln x_i; && (2.3) \\ &\text{Maximize } Er_1(x) = \sum_{i=1}^n r_i^1 x_i; \\ &\text{Maximize } Er_2(x) = \sum_{i=1}^n r_i^2 x_i; \\ &\dots\dots\dots \\ &\text{Maximize } Er_m(x) = \sum_{i=1}^n r_i^m x_i; \\ &\text{Minimize } Vr_1(x) = \sum_{i=1}^n \sum_{i=1}^n \sigma_{ii}^1 x_i x_i; \\ &\text{Minimize } Vr_2(x) = \sum_{i=1}^n \sum_{i=1}^n \sigma_{ii}^2 x_i x_i; \\ &\dots\dots\dots \\ &\text{Minimize } Vr_m(x) = \sum_{i=1}^n \sum_{i=1}^n \sigma_{ii}^m x_i x_i; \\ &\text{Subject to} \\ &\quad \sum_{i=1}^n x_i = 1 \\ &\quad x_i \geq 0, \quad j = 1, 2, \dots, n. \end{aligned}$$

**3. Preliminaries:**

**3.1 Fuzzy Set:**

Fuzzy set was introduced by Zadeh [1] in 1965. A fuzzy set  $\tilde{A}$  in a universe of discourse  $X$  is defined as  $\tilde{A} = \{(x, \mu_{\tilde{A}}(x)) : x \in X\}$ . Here  $\mu_{\tilde{A}} : X \rightarrow [0, 1]$  is a mapping which is called the membership function of the fuzzy set  $\tilde{A}$  and  $\mu_{\tilde{A}}(x)$  is called the membership value of  $x \in X$  in the fuzzy set  $\tilde{A}$ . The larger  $\mu_{\tilde{A}}(x)$  is the stronger the grade of membership form in  $\tilde{A}$ .

**3.2 Neutrosophic Set:**

Let  $X$  be a universe of discourse. A neutrosophic set  $\tilde{A}^n$  in  $X$  is defined by a Truth-membership function  $\mu_A(x)$ , an indeterminacy-membership function  $\sigma_A(x)$  and a falsity-membership function  $v_A(x)$  having the form  $\tilde{A}^n = \{ \langle x, \mu_A(x), \sigma_A(x), v_A(x) \rangle : x \in X \}$ .

Where,  $\mu_A(x) : X \rightarrow ]0^-, 1^+[$   
 $\sigma_A(x) : X \rightarrow ]0^-, 1^+[$   
 $v_A(x) : X \rightarrow ]0^-, 1^+[$  and there is no restriction on the sum of  $\mu_A(x), \sigma_A(x)$  and  $v_A(x)$ .

So,  $0^- \leq \sup \mu_A(x) + \sup \sigma_A(x) + \sup v_A(x) \leq 3^+$ .

**3.3 Single valued Neutrosophic Set:**

Let  $X$  be a universe of discourse. A single valued neutrosophic set  $\tilde{A}^n$  over  $X$  is an object with the form  $\tilde{A}^n = \{ \langle x, \mu_A(x), \sigma_A(x), v_A(x) \rangle : x \in X \}$ , where

$$\begin{aligned} \mu_A(x) &: X \rightarrow [0, 1] \\ \sigma_A(x) &: X \rightarrow [0, 1] \\ v_A(x) &: X \rightarrow [0, 1] \end{aligned}$$

with  $0 \leq \mu_A(x) + \sigma_A(x) + v_A(x) \leq 3, \forall x \in X$ .

**3.4 Complement of Single valued Neutrosophic Set:**

Let  $X$  be a universe of discourse. The complement of a single valued neutrosophic set  $\tilde{A}^n$  is denoted by  $c(\tilde{A}^n)$  and is defined by

$$\begin{aligned} \mu_{c(\tilde{A}^n)}(x) &= v_A(x) \\ \sigma_{c(\tilde{A}^n)}(x) &= 1 - \sigma_A(x) \\ v_{c(\tilde{A}^n)}(x) &= \mu_A(x), \quad \forall x \in X. \end{aligned}$$

**3.5 Union of two Single valued Neutrosophic Sets:**

The union of two single valued neutrosophic sets  $\tilde{A}^n$  and  $\tilde{B}^n$  is a single valued neutrosophic set  $\tilde{C}^n$ , where  $\tilde{C}^n = \tilde{A}^n \cup \tilde{B}^n$  and

$$\begin{aligned} \mu_c(x) &= \max(\mu_A(x), \mu_B(x)) \\ \sigma_c(x) &= \max(\sigma_A(x), \sigma_B(x)) \\ v_c(x) &= \min(v_A(x), v_B(x)), \quad \forall x \in X. \end{aligned}$$

**3.6 Intersection of two Single valued Neutrosophic Sets:**

The union of two single valued neutrosophic sets  $\bar{A}^n$  and  $\bar{B}^n$  is a single valued neutrosophic set  $\bar{C}^n$ , where  $\bar{C}^n = \bar{A}^n \cup \bar{B}^n$  and

$$\begin{aligned} \mu_c(x) &= \max(\mu_A(x), \mu_B(x)) \\ \sigma_c(x) &= \max(\sigma_A(x), \sigma_B(x)) \\ \nu_c(x) &= \min(\nu_A(x), \nu_B(x)), \forall x \in X. \end{aligned}$$

**4. Neutrosophic Optimization Method to solve minimization type multi-objective non-linear programming problem.**

A minimization type multi-objective non-linear problem is of the form

$$\begin{aligned} \text{Min } \{f_1(x), f_2(x), \dots, f_n(x)\} \\ g_i(x) \leq b_i, \quad i = 1, 2, \dots, q \end{aligned} \tag{4.1}$$

We define the decision set  $\bar{D}^n$  which is a conjunction of neutrosophic objectives and constraints and is defined by

$$\begin{aligned} \bar{D}^n &= (\cap_{i=1}^p \mathcal{G}_i^n) \cap (\cap_{j=1}^q \mathcal{C}_j^n) = \{(x, \mu_{\bar{D}^n}(x), \sigma_{\bar{D}^n}(x), \nu_{\bar{D}^n}(x))\}, \text{ where} \\ \mu_{\bar{D}^n}(x) &= \min\{\mu_{f_1}(x), \mu_{f_2}(x), \dots, \mu_{f_n}(x); \mu_{g_1}(x), \mu_{g_2}(x), \dots, \mu_{g_q}(x)\}, \forall x \in X. \\ \sigma_{\bar{D}^n}(x) &= \min\{\sigma_{f_1}(x), \sigma_{f_2}(x), \dots, \sigma_{f_n}(x); \sigma_{g_1}(x), \sigma_{g_2}(x), \dots, \sigma_{g_q}(x)\}, \forall x \in X. \\ \nu_{\bar{D}^n}(x) &= \max\{\nu_{f_1}(x), \nu_{f_2}(x), \dots, \nu_{f_n}(x); \nu_{g_1}(x), \nu_{g_2}(x), \dots, \nu_{g_q}(x)\}, \forall x \in X. \end{aligned}$$

Here  $\mu_{\bar{D}^n}(x), \sigma_{\bar{D}^n}(x), \nu_{\bar{D}^n}(x)$  are Truth-membership function, indeterminacy-membership function and falsity-membership function of neutrosophic decision set respectively.

Now the transformed non-linear programming problem of the problem (4.1) can be written as

$$\begin{aligned} \text{Max } \alpha \\ \text{Max } \gamma \\ \text{Min } \beta \\ \text{With } \mu_{\bar{D}^n}(x) \geq \alpha \\ \mu_{\bar{D}^n}(x) \geq \alpha \\ \sigma_{\bar{D}^n}(x) \geq \gamma \\ \sigma_{\bar{D}^n}(x) \geq \gamma \\ \nu_{\bar{D}^n}(x) \leq \beta \\ \nu_{\bar{D}^n}(x) \leq \beta, \quad (k = 1, 2, \dots, p; \quad j = 1, 2, \dots, q) \\ \alpha + \beta + \gamma \leq 3 \\ \alpha \geq \beta \\ \alpha \geq \gamma \\ \alpha, \beta, \gamma \in [0, 1] \end{aligned} \tag{4.2}$$

**5. Computational Algorithm:**

**Step-1:** First we convert all the objective functions of the problem (2.3) into minimization type. So the problem (2.3) becomes

$$\begin{aligned} \text{Minimize } -EN(x) &= -\sum_{i=1}^n x_i \ln x_i \\ \text{Minimize } -Er_1(x) &= -\sum_{i=1}^n r_i^1 x_i \\ \text{Minimize } -Er_2(x) &= -\sum_{i=1}^n r_i^2 x_i \\ &\dots\dots\dots \\ \text{Minimize } -Er_m(x) &= -\sum_{i=1}^n r_i^m x_i \\ \text{Minimize } Vr_1(x) &= \sum_{i=1}^n \sum_{j=1}^n \sigma_{ij}^1 x_i x_j \\ \text{Minimize } Vr_2(x) &= \sum_{i=1}^n \sum_{j=1}^n \sigma_{ij}^2 x_i x_j \\ &\dots\dots\dots \\ \text{Minimize } Vr_m(x) &= \sum_{i=1}^n \sum_{j=1}^n \sigma_{ij}^m x_i x_j \\ \text{Subject to} & \\ \sum_{i=1}^n x_i &= 1 \\ x_i &\geq 0, \quad j = 1, 2, \dots, n. \end{aligned} \tag{5.1}$$

Let us rename the above  $(2m + 1)$  objective functions as  $f_1(x), f_2(x), \dots, f_{2m+1}(x)$  respectively. Now solve the problem (5.1) as a single objective non-linear programming problem using only one objective at a time and ignoring the others. These solutions are known as ideal solutions.

**Step-2:** From the results of step 1, determine the corresponding values for every objective at each solution derived. With the values of all objectives at each ideal solution, pay-off matrix can be formulated as follows:

$$\begin{pmatrix} f_1^*(x^1) & f_2^*(x^1) & \dots & f_{2m+1}^*(x^1) \\ f_1(x^2) & f_2^*(x^2) & \dots & f_{2m+1}^*(x^2) \\ \dots & \dots & \dots & \dots \\ f_1(x^{2m+1}) & f_2(x^{2m+1}) & \dots & f_{2m+1}(x^{2m+1}) \end{pmatrix}$$

**Step-3:** For each objective  $f_k(x)$ , ( $k = 1, 2, \dots, 2m+1$ ), we now find lower and upper bounds  $L_k^\mu$  and  $U_k^\mu$  respectively for truth-membership of objectives.

$L_k^\mu = \min f_k(x^{r*})$  and  $U_k^\mu = \max f_k(x^{r*})$ , where  $r = 1, 2, \dots, 2m+1$ ;  $k = 1, 2, \dots, 2m+1$ .

The upper and lower bounds for indeterminacy and falsity membership of objectives can be calculated as follows:

$U_k^v = U_k^\mu$  and  $L_k^v = L_k^\mu + t(U_k^\mu - L_k^\mu)$ .

$U_k^s = L_k^\mu + s(U_k^\mu - L_k^\mu)$  and  $L_k^s = L_k^\mu$ .

Here  $t$  and  $s$  are predetermined real number in  $(0,1)$ .

**Step-4:** We define Truth-membership function, indeterminacy-membership function and falsity-membership function as follows:

$$\begin{aligned} \mu_k(f_k(x)) &= 1 && \text{for } f_k(x) \leq L_k^\mu \\ \mu_k(f_k(x)) &= (U_k^\mu - f_k(x)) / (U_k^\mu - L_k^\mu), && \text{for } L_k^\mu \leq f_k(x) \leq U_k^\mu \\ \mu_k(f_k(x)) &= 0 && \text{for } f_k(x) \geq U_k^\mu \end{aligned}$$

$$\begin{aligned} \sigma_k(f_k(x)) &= 1 && \text{for } f_k(x) \leq L_k^s \\ \sigma_k(f_k(x)) &= (U_k^s - f_k(x)) / (U_k^s - L_k^s), && \text{for } L_k^s \leq f_k(x) \leq U_k^s \\ \sigma_k(f_k(x)) &= 0 && \text{for } f_k(x) \geq U_k^s \end{aligned}$$

$$\begin{aligned} \nu_k(f_k(x)) &= 0 && \text{for } f_k(x) \leq L_k^v \\ \nu_k(f_k(x)) &= (f_k(x) - L_k^v) / (U_k^v - L_k^v), && \text{for } L_k^v \leq f_k(x) \leq U_k^v \\ \nu_k(f_k(x)) &= 1 && \text{for } f_k(x) \geq U_k^v \end{aligned}$$

**Step-5:** Now by using neutrosophic optimization method, we can write the problem (4.2) as:

$$\text{Max } \alpha - \beta + \gamma \tag{5.2}$$

Such that

$$\begin{aligned} \mu_k(f_k(x)) &\geq \alpha \\ \sigma_k(f_k(x)) &\geq \gamma \\ \nu_k(f_k(x)) &\leq \beta, \text{ for } k = 1, 2, \dots, 2m+1 \\ \alpha + \beta + \gamma &\leq 3 \\ \alpha &\geq \beta \\ \alpha &\geq \gamma \\ \alpha, \beta, \gamma &\in [0,1] \\ g_i(x) &\leq b_i, i = 1, 2, \dots, q, \\ x &\geq 0 \end{aligned}$$

Again we reduce the problem (5.2) to equivalent non-linear programming problem as:

$$\text{Max } \alpha - \beta + \gamma \tag{5.3}$$

Such that  $f_k(x) + (U_k^\mu - L_k^\mu) \cdot \alpha \leq U_k^\mu$

$f_k(x) + (U_k^s - L_k^s) \cdot \gamma \leq U_k^s$

$f_k(x) - (U_k^v - L_k^v) \cdot \beta \leq L_k^v$ ,

for  $k = 1, 2, \dots, 2m+1$

$\alpha + \beta + \gamma \leq 3$

$\alpha \geq \beta$

$\alpha \geq \gamma$

$\alpha, \beta, \gamma \in [0,1]$

$g_i(x) \leq b_i, i = 1, 2, \dots, q,$

$x \geq 0$

So the problem (5.1) is reduced to equivalent non-linear programming problem as:

Model-A:

$$\begin{aligned}
 & \text{Max } \alpha - \beta + \gamma & (5.4) \\
 & -EN(X) + (U_{-EN}^{\mu} - L_{-EN}^{\mu}).\alpha \leq U_{-EN}^{\mu} \\
 & -EN(X) + (U_{-EN}^{\sigma} - L_{-EN}^{\sigma}).\gamma \leq U_{-EN}^{\sigma} \\
 & -EN(X) - (U_{-EN}^{\nu} - L_{-EN}^{\nu}).\beta \leq L_{-EN}^{\nu} \\
 & -E\eta_j(x) + (U_{-E\eta_j}^{\mu} - L_{-E\eta_j}^{\mu}).\alpha \leq U_{-E\eta_j}^{\mu} \\
 & -E\eta_j(x) + (U_{-E\eta_j}^{\sigma} - L_{-E\eta_j}^{\sigma}).\gamma \leq U_{-E\eta_j}^{\sigma} \\
 & -E\eta_j(x) - (U_{-E\eta_j}^{\nu} - L_{-E\eta_j}^{\nu}).\beta \leq L_{-E\eta_j}^{\nu} \\
 & V\eta_j(x) + (U_{V\eta_j}^{\mu} - L_{V\eta_j}^{\mu}).\alpha \leq U_{V\eta_j}^{\mu} \\
 & V\eta_j(x) + (U_{V\eta_j}^{\sigma} - L_{V\eta_j}^{\sigma}).\gamma \leq U_{V\eta_j}^{\sigma} \\
 & V\eta_j(x) - (U_{V\eta_j}^{\nu} - L_{V\eta_j}^{\nu}).\beta \leq L_{V\eta_j}^{\nu}, j = 1, 2, \dots, m. \\
 & \alpha + \beta + \gamma \leq 3 \\
 & \alpha \geq \beta \\
 & \alpha \geq \gamma \\
 & \alpha, \beta, \gamma \in [0, 1] \\
 & \sum_{j=1}^n x_j = 1 \\
 & x_j \geq 0, j = 1, 2, \dots, n.
 \end{aligned}$$

If we take

Max $\alpha$   
 Min $\gamma$   
 Min $\beta$

in problem (4.2), then it reduced to equivalent non-linear programming problem as:

Model-B:

$$\text{Max } \alpha - \beta - \gamma \tag{5.5}$$

And same constraints as problem (5.4).

Now, positive weights  $W_k$  reflect the decision maker's preferences regarding the relative importance of each objective goal  $f_k(x)$  for  $k = 1, 2, \dots, 2m + 1$ .

These weights can be normalized by taking  $\sum W_k = 1$ . If we take weights  $w$  for  $-EN(X)$ ,  $w_{\eta_j}$  for  $-E\eta_j(x)$  and  $w_{V\eta_j}$  for  $V\eta_j(x)$ , where,  $j = 1, 2, \dots, m$  and  $w + \sum_{i=1}^m w_{\eta_i} + \sum_{i=1}^m w_{V\eta_i} = 1$ .

Then the problem (5.4) becomes:

$$\begin{aligned}
 & \text{Max } \alpha - \beta + \gamma & (5.6) \\
 & -wEN(X) + (U_{-EN}^{\mu} - L_{-EN}^{\mu}).\alpha \leq wU_{-EN}^{\mu} \\
 & -wEN(X) + (U_{-EN}^{\sigma} - L_{-EN}^{\sigma}).\gamma \leq wU_{-EN}^{\sigma} \\
 & -wEN(X) - (U_{-EN}^{\nu} - L_{-EN}^{\nu}).\beta \leq wL_{-EN}^{\nu} \\
 & -w_{\eta_j}E\eta_j(x) + (U_{-E\eta_j}^{\mu} - L_{-E\eta_j}^{\mu}).\alpha \leq w_{\eta_j}U_{-E\eta_j}^{\mu} \\
 & -w_{\eta_j}E\eta_j(x) + (U_{-E\eta_j}^{\sigma} - L_{-E\eta_j}^{\sigma}).\gamma \leq w_{\eta_j}U_{-E\eta_j}^{\sigma} \\
 & -w_{\eta_j}E\eta_j(x) - (U_{-E\eta_j}^{\nu} - L_{-E\eta_j}^{\nu}).\beta \leq w_{\eta_j}L_{-E\eta_j}^{\nu} \\
 & w_{V\eta_j}V\eta_j(x) + (U_{V\eta_j}^{\mu} - L_{V\eta_j}^{\mu}).\alpha \leq w_{V\eta_j}U_{V\eta_j}^{\mu} \\
 & w_{V\eta_j}V\eta_j(x) + (U_{V\eta_j}^{\sigma} - L_{V\eta_j}^{\sigma}).\gamma \leq w_{V\eta_j}U_{V\eta_j}^{\sigma} \\
 & w_{V\eta_j}V\eta_j(x) - (U_{V\eta_j}^{\nu} - L_{V\eta_j}^{\nu}).\beta \leq w_{V\eta_j}L_{V\eta_j}^{\nu}, j = 1, 2, \dots, m. \\
 & \alpha + \beta + \gamma \leq 3 \\
 & \alpha \geq \beta \\
 & \alpha \geq \gamma \\
 & \alpha, \beta, \gamma \in [0, 1] \\
 & \sum_{j=1}^n x_j = 1 \\
 & x_j \geq 0, j = 1, 2, \dots, n. \\
 & w + \sum_{i=1}^m w_{\eta_i} + \sum_{i=1}^m w_{V\eta_i} = 1.
 \end{aligned}$$

## 6. Numerical Examples

### 6.1 Numerical Examples (for PSP and PSPD):

Let us consider the three-security problems with expected returns vector and covariance matrix given by

$$(r_1, r_2, r_3) = (0.073, 0.165, 0.133) \text{ and}$$

$$\begin{aligned}
 \sigma_1^2 &= 0.0152, \rho_{12}\sigma_1\sigma_2 = 0.0211, \rho_{13}\sigma_1\sigma_3 = 0.0197 \\
 \sigma_2^2 &= 0.0678, \sigma_3^2 = 0.0294, \rho_{23}\sigma_2\sigma_3 = 0.0256
 \end{aligned}$$



Let  $x = (x_1, x_2, x_3)^T$ , where  $x_1, x_2, x_3$  is the proportion of an asset invested in the 1-st, 2-nd and 3-rd security respectively.

So model-1 (PSP) is

$$\text{Maximize } Er(x) = 0.073 x_1 + 0.165 x_2 + 0.133 x_3 \quad (6.1)$$

$$\text{Minimize } Vr(x) = 0.0152 x_1^2 + 0.0678 x_2^2 + 0.0294 x_3^2 \\ + 2(0.0211 x_1 x_2 + 0.0197 x_1 x_3 + 0.0256 x_2 x_3)$$

Subject to

$$x_1 + x_2 + x_3 = 1, \\ \text{and } x_1, x_2, x_3 \geq 0.$$

And Model-II (PSPD) is

$$\text{Maximize } En(x) = -(x_1 \ln x_1 + x_2 \ln x_2 + x_3 \ln x_3) \quad (6.2)$$

$$\text{Maximize } Er(x) = 0.073 x_1 + 0.165 x_2 + 0.133 x_3$$

$$\text{Minimize } Vr(x) = 0.0152 x_1^2 + 0.0678 x_2^2 + 0.0294 x_3^2 \\ + 2(0.0211 x_1 x_2 + 0.0197 x_1 x_3 + 0.0256 x_2 x_3)$$

subject to

$$x_1 + x_2 + x_3 = 1, \\ \text{and } x_1, x_2, x_3 \geq 0.$$

Converting problem (6.2) into minimization problem, we have

$$\text{Minimize } -En(x) = (x_1 \ln x_1 + x_2 \ln x_2 + x_3 \ln x_3) \quad (6.3)$$

$$\text{Minimize } -Er(x) = -(0.073 x_1 + 0.165 x_2 + 0.133 x_3)$$

$$\text{Minimize } Vr(x) = 0.0152 x_1^2 + 0.0678 x_2^2 + 0.0294 x_3^2 \\ + 2(0.0211 x_1 x_2 + 0.0197 x_1 x_3 + 0.0256 x_2 x_3)$$

subject to

$$x_1 + x_2 + x_3 = 1, \\ \text{and } x_1, x_2, x_3 \geq 0.$$

Here

$$L_{-En}^{\mu} = -1.0986,$$

$$L_{-En}^{\nu} = -1.0986 + (-1.0986)t,$$

$$L_{-En}^{\sigma} = -1.0986$$

$$U_{-En}^{\mu} = 0, U_{-En}^{\nu} = 0, U_{-En}^{\sigma} = -1.0986 + (-1.0986)s$$

$$L_{-Er}^{\mu} = -0.165,$$

$$L_{-Er}^{\nu} = -0.165 + 0.092.t,$$

$$L_{-Er}^{\sigma} = -0.165$$

$$U_{-Er}^{\mu} = -0.073,$$

$$U_{-Er}^{\nu} = -0.165 + 0.092.s,$$

$$U_{-Er}^{\sigma} = -0.073$$

$$L_{Vr}^{\mu} = 0.0152,$$

$$L_{Vr}^{\nu} = 0.0152 + 0.0526.t,$$

$$L_{Vr}^{\sigma} = 0.0152$$

$$U_{Vr}^{\mu} = 0.0678,$$

$$U_{Vr}^{\nu} = 0.0152 + 0.0526.s,$$

$$U_{Vr}^{\sigma} = 0.0678$$

We take  $t = 0.4, s = 0.6$  in all the examples which are considered in this paper.

So optimal solutions for model-1 (PSP) and Model-II (PSPD) are given below (Table-1):

Model	$x_1$	$x_2$	$x_3$	$Er(x^*)$	$Vr(x^*)$	$En(x^*)$
Model- I (PSP)	0	0.20398	0.79602	0.13953	0.02976	0.78721
Model- II (PSPD)	0.05328	0.2850	0.66172	0.13892	0.03011	0.78721

Table-1: Optimal solutions of Model-I and Model-II.

We see that model-I has one variable  $x_1$  with zero value whereas there is no non-zero value of  $x_1, x_2, x_3$  in Model-II. Here entropy is acted as a measure of dispersal of assets investment with small changes of  $Er(x)$ ,  $Vr(x)$ . If an investor wishes to distribute his asset in various bonds, the PSPD (Model-II) will be more realistic for him.

Comparison of Model-A & Model-B are given below (Table-2):

Model	$\alpha$	$\beta$	$\gamma$	$x_1^*$	$x_2^*$	$x_3^*$	$Er(x^*)$	$Vr(x^*)$	$En(x^*)$
Model-A	0.717	0	0.528	0.053	0.285	0.662	0.139	0.03	0.787
Model-B	0.717	0	0	0.053	0.285	0.662	0.139	0.03	0.787

Table-2: Optimal solutions of Model-A and Model-B.

In Model-A (where we maximize  $\gamma$ ), we see that there is an indeterminacy but in Model-B (where we minimize  $\gamma$ ), there is no indeterminacy condition. So we can conclude that Model-B is no longer neutrosophic set, it becomes intuitionistic set. The result is only for this particular model which we considered in this paper. We verify this by taking different problems of Portfolio model and we get same results except the value of  $\gamma$  in each problem. In Model-A, we have positive value of  $\gamma$  and in Model-B we get  $\gamma$  as 0.

For using different weights, optimal solution of Model-II is given below (Table-3):

Weights	$x_1$	$x_2$	$x_3$	$Er(x^*)$	$Vr(x^*)$	$En(x^*)$	Type
$w_e = 1/3$ $w_v = 1/3$ $w = 1/3$	0.05328	0.28499	0.66173	0.13892	0.03011	0.78721	I
$w_e = 0.26$ $w_v = 0.17$ $w = 0.57$	0.109	0.16616	0.72484	0.13178	0.02754	0.77307	II
$w_e = 0.12$ $w_v = 0.48$ $w = 0.4$	0	0.47698	0.52302	0.14826	0.03624	0.69209	III

Table-3: Optimal solutions of Model-II .

Here, results have been presented for model-II with the different weights to the objectives. Types-I, II and III , give respectively, the results with equal importance of the objectives, more importance of the expected return and more importance of the risk.

## 6.2 Numerical example of GPSPD :

Consider the three-security problems with expected returns vector and covariance matrix given by

$$(\sigma_1^1, \sigma_2^1, \sigma_3^1) = (0.073, 0.165, 0.133) \text{ and}$$

$$(\sigma_1^1)^2 = 0.0152, \rho_{12}^1 \sigma_1^1 \sigma_2^1 = 0.0211, \rho_{13}^1 \sigma_1^1 \sigma_3^1 = 0.0197$$

$$(\sigma_2^1)^2 = 0.0678, (\sigma_3^1)^2 = 0.0294, \rho_{23}^1 \sigma_2^1 \sigma_3^1 = 0.0256$$

$$(\sigma_1^2, \sigma_2^2, \sigma_3^2) = (0.104, 0.187, 0.077) \text{ and}$$

$$(\sigma_1^2)^2 = 0.0685, \rho_{12}^2 \sigma_1^2 \sigma_2^2 = 0.0171,$$

$$(\sigma_2^2)^2 = 0.0327, (\sigma_3^2)^2 = 0.0843, \rho_{23}^2 \sigma_2^2 \sigma_3^2 = 0.0121$$

$$(\sigma_1^3, \sigma_2^3, \sigma_3^3) = (0.082, 0.106, 0.128) \text{ and}$$

$$(\sigma_1^3)^2 = 0.0273, \rho_{12}^3 \sigma_1^3 \sigma_2^3 = 0.0133, \rho_{13}^3 \sigma_1^3 \sigma_3^3 = 0.0152$$

$$(\sigma_2^3)^2 = 0.0726, (\sigma_3^3)^2 = 0.0147, \rho_{23}^3 \sigma_2^3 \sigma_3^3 = 0.0116$$

So the optimal solutions of GPSPD is

$$x_1 = 0.08699, x_2 = 0.54754, x_3 = 0.36548,$$

$$Er_1(x) = 0.1453, Er_2(x) = 0.139578,$$

$$Er_3(x) = 0.111953$$

$$Vr_1(x) = 0.0378765, Vr_2(x) = 0.028769,$$

$$Vr_3(x) = 0.0395095, En(x) = 0.910089.$$

For using different weights, optimal solution of GPSPD are given below (Table-4):

Weights	$Er_1(x^*)$	$Er_2(x^*)$	$Er_3(x^*)$	$Vr_1(x^*)$	$Vr_2(x^*)$	$Vr_3(x^*)$	$En(x^*)$	Type
$w_{e1} = w_{e2} = w_{e3} =$ $w_{v1} = w_{v2} = w_{v3} =$ $w = 1/7$	0.1453	0.13958	0.11195	0.03788	0.02877	0.03951	0.91009	I
$w_{e1} = w_{e2} = w_{e3} =$ 0.04, $w_{v1} = w_{v2} = w_{v3}$ =0.14, $w = 0.46$	0.14475	0.13728	0.11248	0.03702	0.02948	0.03856	0.91493	II
$w_{e1} = w_{e2} = w_{e3}$ =0.12, $w_{v1} = w_{v3} = 0.1,$ $w_{v2} = 0.03$ $w = 0.41$	0.14538	0.13992	0.11187	0.03801	0.02867	0.03965	0.9092	III
$w_{e1} = w_{e2} = 0.15$ $w_{e3} = 0.06,$ $w_{v1} = w_{v2} = w_{v3}$ =0.09, $w = 0.37$	0.14552	0.1405	0.11174	0.03823	0.02851	0.0399	0.90759	IV

**Table-4:**Optimal solutions of GPSPD.

Here, results have been presented with the different weights to the objectives. Types-I, II, III and IV give, respectively, the results with equal importance of the objectives, more importance of the expected returns, more importance of the anyone expected return say  $Er_3(x^*)$  and more importance of the any one risk say  $Vr_3(x^*)$ . We also consider the condition if we do not consider falsity and indeterminacy membership functions in objective function. We see that the result remains same except the value of  $\alpha$  (truth membership function).

## 7. Conclusion:

In this paper, we consider a general application of portfolio selection problem in fuzzy environment. We first consider a multi-objective Portfolio Selection model and then we added another entropy objective function and next we generalized the model. Neutrosophic optimization technique is used to solve the problems. We also take different weights on objective functions. The models are illustrated with numerical examples. The method presented in the paper is quite general and can be applied to other areas of Operation Research and Engineering Sciences.

## Acknowledgements

The authors are thankful to University of Kalyani for providing financial assistance through DST-PURSE Programme and UGC SAP (Phase-2).

## References

- [1] L.A. Zadeh, "Fuzzy sets", *Information and Control* 8, (1965), 338–353.
- [2] Roll, S. "A critique of the asset processing theory tests" *Journal of finance economics*, 4, (1977), 129-176.
- [3] Inuiguchi, M. and Tanino, T. "Portfolio selection under independent possibilistic information", *Fuzzy Sets and Systems*, 115, (2000), 83-92.
- [4] Kapur, J. N. *Maximum-Entropy Models in Science and Engineering*, Revised ed. Wiley Eastern Limited, New Delhi, 1993.
- [5] Markowitz, H.M. "Portfolio Selection" *Journal of Finance*, 1, (1952), 1851-1853.
- [6] Kapur, J. N. and Kesavan, H. K. *Entropy Optimization Principles with Applications*, Academic Press, Inc., San Diego, 1992.
- [7] Wang, S.Y. and Zhu, S.S. "Fuzzy Portfolio Optimization" *International Journal of Mathematical Sciences*, 2, (2003), 133- 144.
- [8] K. Atanassov, "Intuitionistic fuzzy sets", *Fuzzy sets and systems*, vol-20, (1986), pp 87-96.
- [9] Pintu Das, T.K.Roy, "Multi-objective non-linear programming problem based on Neutrosophic Optimization Technique and its application in Riser Design Problem", *Neutrosophic Sets and Systems*, vol-9, 2015, p- 88-95.
- [10] K. Atanassov, "Interval valued intuitionistic fuzzy sets." *Fuzzy sets and systems*, vol- 31, (1989), pp 343-349.
- [11] F. Smarandache, *Neutrosophy, Neutrosophic probability, set and logic*, Amer. Res. Press, Rehoboth, USA, (1998), 105.
- [12] H. Wang, F. Smarandache, Y. Zhang, and R. Sunderraman, *single valued neutrosophic sets, multispace and multistructure*, vol-4, (2010), pp 410-413.
- [13] H.J. Zimmermann, *Fuzzy programming and linear programming with several objective functions*, *Fuzzy Sets and Systems* 1, (1978), 45–55.
- [14] Bellman R, Zadeh LA (1970) Decision making in fuzzy environment. *Management Science* 17 (4), (1970), B141-B164.
- [15] S Pramanik. Neutrosophic multi-objective linear programming. *Global Journal of Engineering Science and Research Management* 3 (8), (2016) , 36-46.
- [16] S Pramanik. Neutrosophic linear goal programming. *Global Journal of Engineering Science and Research Management* 3 (7), (2016), 01-11.
- [17] M. Sarkar, T. K. Roy. Optimization of welded beam structure using neutrosophic optimization technique: a comparative study. *International Journal of Fuzzy Systems*. (2017), DOI 10.1007/s40815-017- 0362-6
- [18] Abdel-Baset, M., Hezam, I. M., & Smarandache, F. Neutrosophic goal programming. *Neutrosophic Sets and Systems* 11, (2016), 112 – 118.
- [19] Hezam, I. M., Abdel-Baset, M., & Smarandache, F. Taylor series approximation to solve neutrosophic multi-objective programming problem. *Neutrosophic Sets and Systems* 10, (2015), 39 – 45.
- [20] Sahidul Islam, Tanmay Kundu, Application of Neutrosophic Optimization Technique on Multi- objective Reliability Optimization Model, *Neutrosophic Operaton Research*, volume II.

Received: July 23, 2018. Accepted: August 13, 2018.



# PEST Analysis Based on Neutrosophic Cognitive Maps: A Case Study for Food Industry

Ramona Parraga Alava <sup>1</sup>, José Muñoz Murillo <sup>2</sup>, Roy Barre Zambrano <sup>3</sup>, María Isabel Zambrano Vélez<sup>4</sup>, Maikel Leyva Vázquez<sup>5</sup>

<sup>1</sup>Facultad de Ciencias Zootécnicas, Universidad Técnica de Manabí, Chone Ecuador Correo ingceciliaparraga@gmail.com.

<sup>2</sup>Facultad de Ciencias Zootécnicas, Universidad Técnica de Manabí, Chone Ecuador. jpmunoz@utm.edu.ec.

<sup>3</sup>Pontificia Universidad Católica del Ecuador Sede Manabí, Chone Ecuador. Correo rolebaz@hotmail.com

<sup>4</sup>Facultad de Ciencias Zootécnicas, Universidad Técnica de Manabí, Chone Ecuador. Email: isazambrano82@hotmail.com

<sup>5</sup>Universidad de Guayaquil, Facultad de Ciencias Matemáticas y Físicas, Guayaquil Ecuador. Email: mleyvaz@gmail.com

**Abstract.**Neutrosophic cognitive maps and its application in decision making have become a topic of great importance for researchers and practitioners alike. PEST (Political, Economic, Social and Technological), analysis is a precondition analysis with the main functions of the identification of the environment within which and organization or project the operates and providing data and information for enabling the organization to make predictions about new situations and circumstances. In this paper, a new model PEST analysis for food industry is presented based on neutrosophic cognitive maps static analysis. The proposed framework is composed of four activities, identifying PEST factors and sub-factors, modeling interrelation among PEST factors, calculate centrality measures and factor classification and ranking. A case study is presented for food industry environment analysis. Our approach allows ranking of factors based in interrelation and incorporating indeterminacy in the analysis. Further works will concentrate extending the model for incorporating scenario analysis and group decision making

**Keywords:**PEST, Neutrosophy, Neutrosophic Cognitive Maps, Static Analysis, Food Industry.

## 1 Introduction

PEST (Political, Economic, Social and Technological) analysis, is used to assess these four factors in relation to business or project situation [1]. If environment and legal factors are included it is named PESTEL (Political, Economic, Socio-cultural, Technological, Environment and Legal) analysis [2]. PEST analysis lacks a quantitative approach to the measurement of interrelation among factors.

Fuzzy cognitive maps (FCM) is a tool for modeling and analyzing interrelations [3]. Connections in FCMs are just numeric ones therefore relationship of two events should be linear [4]. Neutrosophy can handle indeterminate and inconsistent information, while fuzzy sets and intuitionistic fuzzy sets don't describe them appropriately [4].

Neutrosophic cognitive maps (NCM) is an extension of FCM where indeterminacy is included [5, 6]. The concept of fuzzy cognitive maps fails to deal with the indeterminate relation [7]. Neutrosophic Logic (NL) was introduced as a generalization of the fuzzy logic [8]. A logical proposition P is characterized by three neutrosophic components:

$$NL(P) = (T, I, F) \tag{1}$$

T is the degree of truth, F the degree of falsehood, and I the degree of indeterminacy. Neutrosophic Sets (NS) was introduced by F. Smarandache who introduced the degree of indeterminacy (I) as independent component [9].

A neutrosophic matrix is a matrix where the elements  $a_{ij}$  have been replaced by elements in  $\langle R \cup I \rangle$ . A neutrosophic graph is a graph in which at least one edge is a neutrosophic edge [10]. If indeterminacy is introduced in cognitive mapping it is called Neutrosophic Cognitive Map (NCM) [11, 12]. NCM are based on neutrosophic logic to represent uncertainty and indeterminacy in cognitive maps [13]. A NCM is a directed graph in

which at least one edge is an indeterminacy denoted by dotted lines [14] (Figure 1.). NCMs are generalization of Fuzzy Cognitive Maps [15]. Recent development on NCM have been presented for example in the classification of Rheumatoid Arthritis disease with Dynamic Neutrosophic Cognitive Map with Bat Algorithm [16].

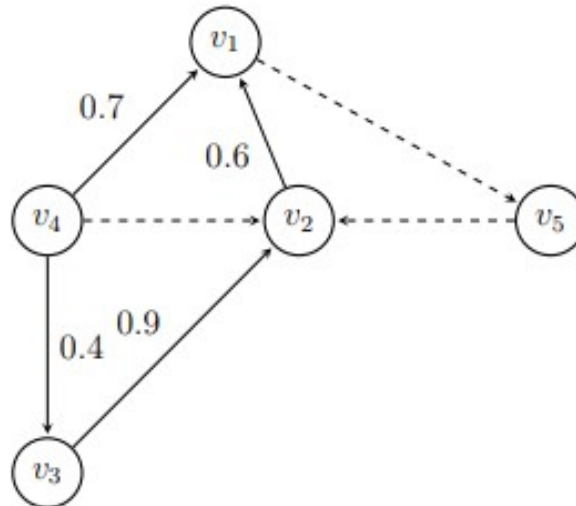

Figure 1: Neutrosophic Cognitive Map example.

In this paper a new model PEST analysis based on neutrosophic cognitive maps is presented giving methodological support and the possibility of dealing with interdependence, feedback and indeterminacy. Additionally the new approach make possible to rank and to reduce factors.

This paper is structured as follows: Section 2 reviews some important concepts about PEST analysis framework, a framework for PEST analysis based on NCM static analysis is presented. Section 4 shows a case study of the proposed model applied to food industry. The paper ends with conclusions and further work recommendations.

## 2 Preliminaries

In this section, we first provide a brief revision PEST analysis and the interdependency of its factors.

### 2.1 PEST Analysis

PEST (Political, Economic, Social and Technological), analysis is a precondition analysis with the mains function of the identification of the environment within which and organization or project the operates and providing data and information for enabling the organization to make predictions about new situations and circumstances [17, 18]. Factors in PEST analyzed are generally measured and evaluated independently [2] not taking into account interdependency. In [19] a new approach based on fuzzy decision maps is presented taking into account ambiguity, vagueness in their interrelations

This study presents a model to address problems encountered in the measurement and evaluation process of PEST taking into account interdependencies among sub-factors. The integrated structure of PESTEL sub-factors were modeled by NCM and quantitative analysis is developed based on static analysis making possible to rank and to reduce factors.

For developing a quantitative analysis of PEST factor based on NCM a static analysis is needed. In [5] a model static analysis model for NCM is presented. The result of the static analysis result is in the form of neutrosophic numbers  $a+bI$ , for  $a, b \in \mathbb{R}$  (all real numbers), which consists in the determinate part  $a$  and the indeterminate part  $bI$ [20]. So it can express determinate and/or indeterminate information in incomplete, uncertain, and indeterminate problems. A de-neutrosophication process as proposed by Salmeron and Smarandachecould be applied final ranking value[21] for the PEST analysis.

## 3. Proposed Framework

Our aim is to develop and further detail a framework based on PEST and NCM[22]. The model consists of the following four phases (graphically, **Figure 2**).

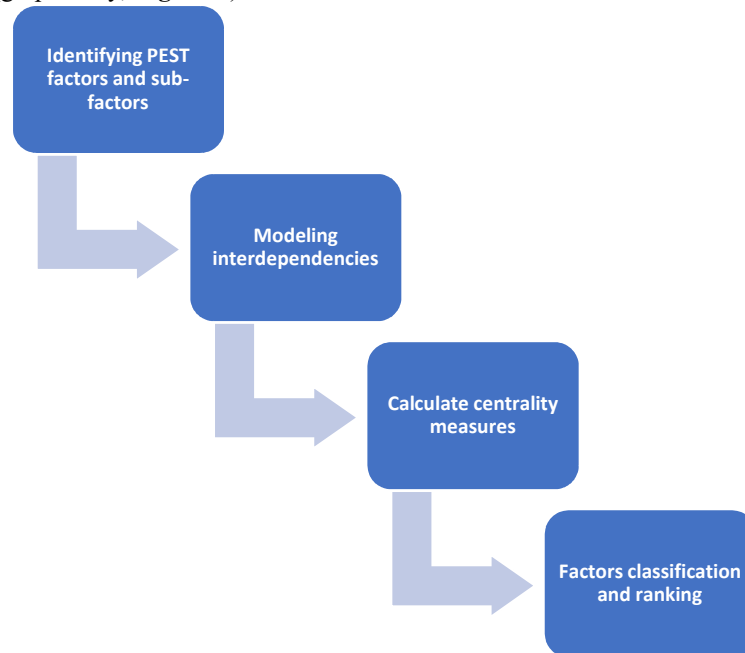

**Figure 2:** Proposed framework for PEST analysis.

### 3.1 Identifying PEST factors and sub-factors

In this step relevant PEST factors and sub-factors are identified. PEST factors are derived from the themes: political, economic, socio-cultural, technological factors. Identifying PEST factors and sub-factors to form a hierarchical structure of PEST model is the main goal.

The model consists of three levels[2]. The first level includes the objective function that is “to analyze the food industry’s macro environment”. The second level contains the 4 main factors of the PEST analysis. The third level of the model consists of sub-factors clustered within the main factors.

### 3.2 Modeling interdependencies

Causal interdependencies among PEST sub-factors are modeled. This step consists of the formation of NCM of sub-factors, according to the views of an expert or expert’s team.

When a set of experts ( $k$ ) participates, the adjacency matrix of the collective NCM is calculated as follows:

$$E = \mu(E_1, E_2, \dots, E_k) \quad (2)$$

the operator is usually the arithmetic mean [23].

### 3.3 Calculate centrality measures

Centrality measures are calculated[24] with absolute values of the NCM adjacency matrix [25]:

1. Outdegree  $od(v_i)$  is the row sum of absolute values of a variable in the neutrosophic adjacency matrix. It shows the cumulative strengths of connections ( $c_{ij}$ ) exiting the variable.

$$od(v_i) = \sum_{j=1}^N c_{ij} \quad (3)$$

2. Indegree  $id(v_i)$  is the column sum of absolute values of a variable. It shows the cumulative strength of variables entering the variable.

$$id(v_i) = \sum_{j=1}^N c_{ji} \quad (4)$$

3. The centrality (total degree  $td(v_i)$ ), of a variable is the summation of its indegree (in-arrows) and out-degree (out-arrows)

$$td(v_i) = od(v_i) + id(v_i) \quad (5)$$

### 3.4 Factors classification and ranking

Factors are classified according to the following rules:

- Transmitter variables have a positive or indeterminacy outdegree,  $od(v_i)$  and zero indegree,  $id(v_i)$ .
- Receiver variables have a positive indegree or indeterminacy,  $id(v_i)$ , and zero outdegree,  $od(v_i)$ .
- Ordinary variables have both a non-zero indegree and. Ordinary variables can be more or less a receiver or transmitter variables, based on the ratio of their indegrees and outdegrees.

A de-neutrosophication process gives an interval number for centrality based on max-min values of I . A neutrosophic value is transformed in an interval with two values, the maximum and the minimum value  $\in [0,1]$  .

The contribution of a variable in a NCM can be understood by calculating its degree centrality, which shows how connected the variable is to other variables and what the cumulative strength of these connections are. The median of the extreme values as proposed by Merigo[26] is used to give an unified centrality value :

$$\lambda([a_1, a_2]) = \frac{a_1 + a_2}{2} \quad (6)$$

Then

$$A > B \Leftrightarrow \frac{a_1 + a_2}{2} > \frac{b_1 + b_2}{2} \quad (7)$$

Finally, a ranking of variables is given.

The numerical value it used for sub-factor prioritization and/or reduction [27]. Threshold values may be set to the 10 % of the total sum of total degree measures for subfactor reduction. Additionally, sub-factor could be grouped by parent factor a to extend the analysis to political economical social and technological general factor.

## 4Case Study

This case study is a demonstrative example from real data modeled by an expert. PEST analysis identifies external factors which influence a specific business. In this case, we're examining how the food industry could be affected by political, economic, social and technological factors.

Public health policies are pushing the food industry to produces with lower sodium and sugar. Additionally, current policies push for the public to be more conscious when buying foods[28]. Political factor identified include environmental regulations, and evolving health policies. Economics factor of a country like unemployment rates can affect the food industry. Healthier alternatives to foods are more expensive to buy compared to fast food or easy-to-make meals. Economic factor identified are taxation, and consumer spending .

Food industry is not only pushed by governmental authorities, but by consumers, as well. Social factors identified are lifestyle changes and awareness of citizen about ecological issues[29]. Technology can give a competitive edge. In food industry Technology is necessary to create packaging, food labels, and the production of food and for reaching consumers in new and easier methods[30]. As technological factor identified are online presence and technological access.

Initially factors and sub-factors were identified. Figure 3 shows the hierarchical structure.



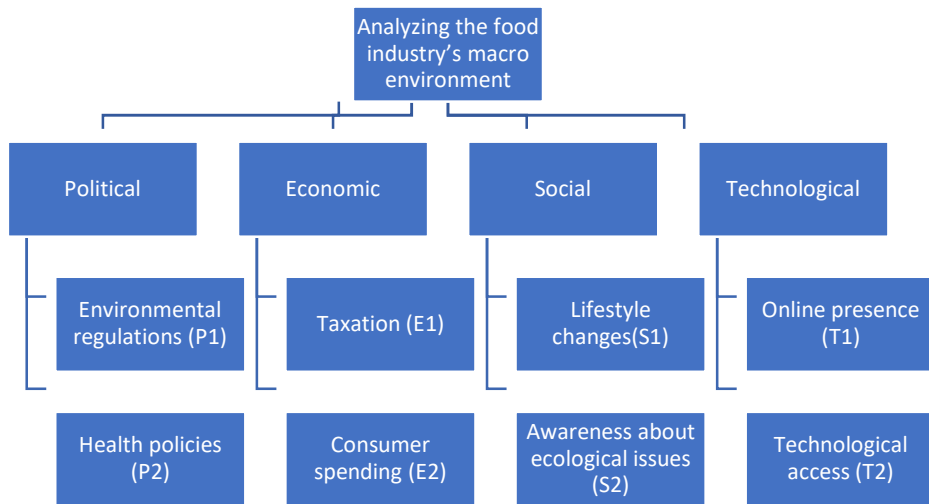

Figure 3: The hierarchical model of PEST in the vertical farming project.

Interdependencies are identified and modeled using a NCM. NCM with weights is represented in Table 1.

	P1	P2	E1	E2	S1	S2	T1	T2
P1	0	0	0	-0.3	0	0	0	0
P2	0	0	0	0	0	0	0.25	0
E1	0	0	0	0.2	0	0	0	0
E2	0	0	0	0	0	0	0	0.3
S1	0.4	I	0	0	0	0	0.3	0
S2	0	0	0	0	I	0	0	0
T1	0	0	0	0.2	0	0	0	0
T2	0	0	0	0.35	0	0	0	0

Table 1: Neutrosophic Adjacency Matrix

The centralities measures are calculated. Outdegree and indegree measures are presented in Table 2.

Node	Id	Od
P1	0.4	0.3
P2	I	0.25
E1	0	0.2
E2	1.05	0.3
S1	I	0.7+I
S2	0	I
T1	0.55	0.2
T2	0.3	0.35

**Table 2:** Centrality measures, outdegree, indegree.

Later nodes are classified. In this case, E2 and S2 nodes are receiver. The rest of the nodes are ordinary.

	Transmitter	Receiver	Ordinary
<b>P1</b>			<b>X</b>
<b>P2</b>			<b>X</b>
<b>E1</b>			<b>X</b>
<b>E2</b>	<b>X</b>		
<b>S1</b>			<b>X</b>
<b>S2</b>	<b>X</b>		
<b>T1</b>			<b>X</b>
<b>T2</b>			<b>X</b>

**Table 3:** Nodes classification

Total degree (Eq. 5) was calculated. Results are show in Table 4.

	td
P1	0.7
P2	0.25+I
E1	0.2
E2	1.35
S1	0.7+2I
S2	I
T1	0.75
T2	0.65

**Table 4:** Total degree

The next step is the de-neutrosophication process as proposed by Salmeron and Smarandache[31].  $I \in [0,1]$  is replaced by both maximum and minimum values. In Table 5 are presented as interval values.

	Td
P1	0.7
P2	[0.25, 1.25]
E1	0.2
E2	1.35
S1	[0.7, 2.7]
S2	[0, 1]
T1	0.75
T2	0.65

**Table 5:** De-neutrosophication, total degree values

Finally we work with the median of the extreme values (Eq 6) [26].

	Td
P1	0.7
P2	0.75
E1	0.2
E2	1.35
S1	1.7
S2	0.5
T1	0.75
T2	0.65

**Table 6:** Total degree using median of the extreme values

Graphically the result is shown in Figure 4.

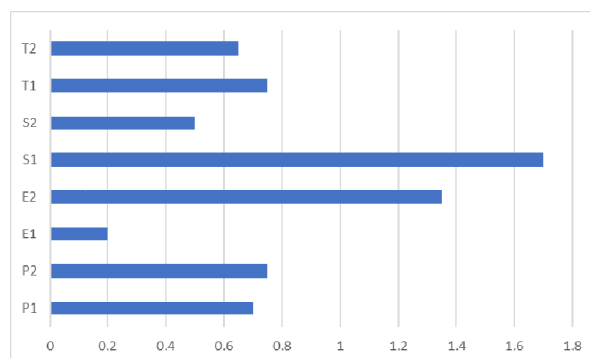
**Figure 4:** Total degree measures

The ranking obtained is as follows:

$$S_1 > E_2 > P_2 \sim T_1 > P_1 > T_2 > S_2 > E_1$$

Lifestyle changes and Consumer spending are the top factors. Centrality measures of sub factor were grouped according to its parent factor (Figure 5).

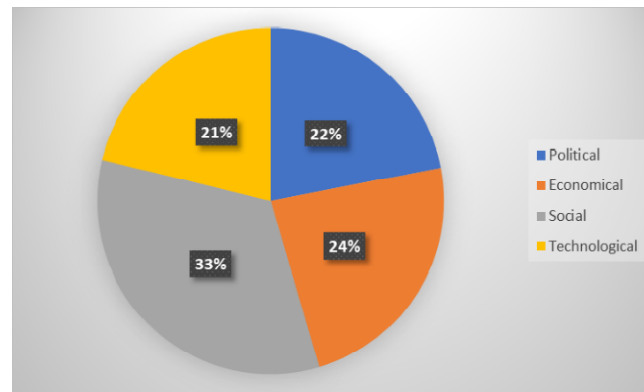

Figure 5: Aggregated total centrality values by factors

Based on total centrality measure, factors with less than 10% of totalsum might be eliminated. According to this rule in current case study E1 could be eliminated. After application of the proposed framework NCM gives a high flexibility and take into account interdependencies PEST analysis.

#### 4. Conclusions

Food industry is affected by political, economic, social and technological factors. This study presents a model to address problems encountered in the measurement and evaluation process of PEST analysis in food industry taking into account interdependencies among sub-factors for modeling uncertainty and indeterminacy. The integrated structure of PEST sub-factors was modeled by NCM and a quantitative analysis is developed based on static analysis. The proposed framework is composed of four activities, identifying PEST factors and sub-factors, modeling interrelation among PEST factors, calculate centrality measures, factor classification and ranking. Further works will concentrate in extending the model for dealing scenario analysis. Another area of future work is the developing a consensus framework for NCM and the development of a software tool.

#### References

- [1] Healey, N.M., *The transition economic of central and eastern Europe: A political, economic, social and technological analysis*. The Columbia Journal of World Business, 1994. **29**(1): p. 62-70.
- [2] Yüksel, I., *Developing a multi-criteria decision making model for PESTEL analysis*. International Journal of Business and Management, 2012. **7**(24): p. 52.
- [3] Leyva-Vázquez, M., et al. *The Extended Hierarchical Linguistic Model in Fuzzy Cognitive Maps*. in *International Conference on Technologies and Innovation*. 2016. Springer.
- [4] Bhutani, K., et al., *Assessing IT Projects Success with Extended Fuzzy Cognitive Maps & Neutrosophic Cognitive Maps in comparison to Fuzzy Cognitive Maps*. Neutrosophic Sets & Systems, 2016. **12**.
- [5] Pérez-Teruel, K. and M. Leyva-Vázquez, *Neutrosophic logic for mental model elicitation and analysis*. Neutrosophic Sets and Systems, 2012: p. 30.
- [6] Kandasamy, W.V. and F. Smarandache, *Fuzzy cognitive maps and neutrosophic cognitive maps*. 2003: Infinite Study.
- [7] Kumar, M., K. Bhutani, and S. Aggarwal. *Hybrid model for medical diagnosis using Neutrosophic Cognitive Maps with Genetic Algorithms*. in *Fuzzy Systems (FUZZ-IEEE), 2015 IEEE International Conference on*. 2015. IEEE.
- [8] Smarandache, F., *A Unifying Field in Logics: Neutrosophic Logic*, in *Philosophy*. 1999, American Research Press. p. 1-141.
- [9] Smarandache, F., *Neutrosophy: neutrosophic probability, set, and logic: analytic synthesis & synthetic analysis*. 1998.

- [10] Kandasamy, W.B.V. and F. Smarandache, *Fuzzy cognitive maps and neutrosophic cognitive maps*. 2003: American Research Press.
- [11] Kandasamy, W.V. and F. Smarandache, *Analysis of social aspects of migrant labourers living with HIV/AIDS using Fuzzy Theory and Neutrosophic Cognitive Maps*. 2004: American Research Press.
- [12] Mondal, K. and S. Pramanik, *A study on problems of Hijras in West Bengal based on neutrosophic cognitive maps*. Neutrosophic Sets and Systems, 2014. **5**: p. 21-26.
- [13] Smarandache, F., *A unifying field in logics: neutrosophic logic. Neutrosophy, neutrosophic set, neutrosophic probability and statistics*. 2005: American Research Press.
- [14] Salmeron, J.L. and F. Smarandache, *Processing Uncertainty and Indeterminacy in Information Systems projects success mapping, in Computational Modeling in Applied Problems: collected papers on econometrics, operations research, game theory and simulation*. 2006, Hexis. p. 94.
- [15] Pramanik, S. and S. Chackrabarti, *A study on problems of construction workers in West Bengal based on neutrosophic cognitive maps*. International Journal of Innovative Research in Science, Engineering and Technology, 2013. **2**(11): p. 6387-6394.
- [16] Chithra, B. and R. Nedunchezian, *Gene selection and dynamic neutrosophic cognitive map with bat algorithm (DNCM-BA) for diagnose of rheumatoid arthritis (RAs)*. 2018, 2018. **7**(2.21): p. 9.
- [17] Frynas, J.G. and K. Mellahi, *Global strategic management*. 2015: Oxford University Press, USA.
- [18] Thompson, J.L. and F. Martin, *Strategic management: awareness & change*. 2010: Cengage Learning EMEA.
- [19] VÁZQUEZ, M.L., et al., *A framework for PEST analysis based on fuzzy decision maps*. Espacios, 2018. **39**(13).
- [20] Jiang, W. and J. Ye, *Optimal design of truss structures using a neutrosophic number optimization model under an indeterminate environment*. Neutrosophic Sets Syst, 2016. **14**: p. 93-97.
- [21] Salmeron, J.L. and F. Smarandache, *Redesigning Decision Matrix Method with an indeterminacy-based inference process*. INTERNATIONAL JOURNAL OF APPLIED MATHEMATICS & STATISTICS, 2008. **13**(M 08): p. 4-11.
- [22] Choez, W.O., et al., *A framework for PEST analysis based on neutrosophic cognitive map: case study in a vertical farming initiative*. Neutrosophic Sets and Systems, vol. 17/2017: A Quarterly International Journal in Information Science and Engineering, 2015. **2**(4): p. 57.
- [23] Takács, M., A. Szakál, and I. Baganj. *The rule of the aggregation operators in fuzzy cognitive maps*. in *Intelligent Engineering Systems (INES), 2017 IEEE 21st International Conference on*. 2017. IEEE.
- [24] Lara, R.B., S.G. Espinosa, and M.Y.L. Vázquez, *Análisis estático en mapas cognitivos difusos basado en una medida de centralidad compuesta*. Ciencias de la Información, 2014. **45**(3): p. 31-36.
- [25] Stach, W., L. Kurgan, and W. Pedrycz, *Expert-based and computational methods for developing fuzzy cognitive maps*, in *Fuzzy Cognitive Maps*. 2010, Springer. p. 23-41.
- [26] Merigó, J., *New extensions to the OWA operators and its application in decision making*, in *Department of Business Administration, University of Barcelona*. 2008.
- [27] Altay, A. and G. Kayakutlu, *Fuzzy cognitive mapping in factor elimination: A case study for innovative power and risks*. Procedia Computer Science, 2011. **3**: p. 1111-1119.
- [28] Moodie, R., et al., *Profits and pandemics: prevention of harmful effects of tobacco, alcohol, and ultra-processed food and drink industries*. The Lancet, 2013. **381**(9867): p. 670-679.
- [29] Booth, S.L., et al., *Environmental and societal factors affect food choice and physical activity: rationale, influences, and leverage points*. Nutrition reviews, 2001. **59**(3): p. S21-S36.
- [30] Earle, M., *Innovation in the food industry*. Trends in Food Science & Technology, 1997. **8**(5): p. 166-175.
- [31] Salmerona, J.L. and F. Smarandache, *Redesigning Decision Matrix Method with an indeterminacy-based inference process*. Multispace and Multistructure. Neutrosophic Transdisciplinarity (100 Collected Papers of Sciences), 2010. **4**: p. 151.

Received: July 25, 2018. Accepted: August 17, 2018.



# An Inventory Model under Space Constraint in Neutrosophic Environment: A Neutrosophic Geometric Programming Approach

Chaitali Kar<sup>1</sup>, Bappa Mondal<sup>2</sup>, Tapan Kumar Roy<sup>3</sup>

<sup>1</sup>Department of Mathematics, Indian Institute of Engineering Science and Technology, Shibpur, Howrah-711 103, West Bengal, India. E-mail: chaitalikar12@gmail.com

<sup>2</sup>Department of Mathematics, Indian Institute of Engineering Science and Technology, Shibpur, Howrah-711 103, West Bengal, India. E-mail: bappa802@gmail.com

<sup>3</sup>Department of Mathematics, Indian Institute of Engineering Science and Technology, Shibpur, Howrah-711 103, West Bengal, India. E-mail: roy.t.k@yahoo.co.in

**Abstract:** In this paper, an inventory model is developed without shortages where the production cost is inversely related to the set up cost and production quantity. In addition, the holding cost is considered time dependent. Here impreciseness is introduced in the storage area. The objective and constraint functions are defined by the truth (membership) degree, indeterminacy (hesitation) degree and falsity (non-membership) degree. Likewise, a non-linear programming problem with a constraint is also considered. Then these are solved by Neutrosophic Geometric Programming Technique for linear membership, hesitation and non-membership functions. Also the solution procedure for Neutrosophic Non-linear Programming Problem is proposed by using additive operator and Geometric Programming method. Numerical examples are presented to illustrate the models using the proposed procedure and the results are compared with the results obtained by other optimization techniques.

**Keywords:** Neutrosophic Sets, Non-linear Programming, Inventory, Additive Operator, Geometric Programming, Neutrosophic Optimization.

## 1 Introduction

In general, most of the classical inventory models assume that the unit production cost and the holding cost of an item are constant and independent in nature. But these assumptions may not be true in real life. In practical situations, unit production cost may depend on the production quantity. Also the unit holding cost may depend on the amount produced. Cheng [1, 2] used these ideas to formulate inventory models and solved them by Geometric Programming (GP) method and obtained closed form optimal solutions. Later on, Jung and Klein [3] developed three cost minimization inventory models: Model 1 considered demand dependent unit cost, Model 2 assumed order quantity dependent unit cost and both of demand and order quantity dependent unit cost is considered in Model 3. All these models are then solved by GP method.

In general, GP is an effective method to solve a class of non-linear problem in comparison with other non-linear methods. The main advantage of GP method is that in this method a complicated problem with non-linear and inequality constraints (primal problem) is converted into an equivalent problem with linear and equality constraints (dual problem). Therefore the dual problem is easier to solve than the primal problem. GP method was first introduced by Zener [4]. Later on, Duffin et al. [5] developed GP method for optimization problems. Kotchenberger [6] was the first Scientist who tackled the inventory problem by GP method. After that, Lee [7] presented a profit maximizing selling price and order quantity problem where the demand is taken as non-linear function of price with a constant elasticity and solved by GP approach. After that, Hariri and Ata [8] presented GP approach for solving a multi-item production lot size inventory model with varying order cost. Later on, Jung and Klein [9] discussed a comparative analysis between the total cost minimization model and the profit maximization model via GP. Then a constrained inventory model of deteriorated items was built-up with and without truncation on the deterioration term and solved using GP method by Mandal et al. [10]. Leung [11] proposed an EPQ model with a flexible and imperfect production process by GP approach and also established more general results using the arithmetic-geometric mean inequality. In the recent era, Wakeel et al. [12] discussed multi-product, multi-vendors inventory models with different cases of rational function under linear and non-linear constraints via GP method.

In many inventory models the objective and constraint goals are assumed to be known. The optimum cost in an inventory model is affected by the restrictions on the storage area, number of orders and production cost. But, in real life, it is not always possible to predict the total cost and resources precisely. So these may be assumed to be fuzzy in nature. In this case, the inventory problem along with the constraints may be realistically represented formulating the model under fuzzy environment and the fuzzy model can be solved by different fuzzy programming methods.

In 1965, Zadeh [13] first introduced the concept of fuzzy set theory. Later on, Bellman and Zadeh [14] introduced fuzzy decision making process. Then Zimmermann [15] solved multi objective linear programming problem based on fuzzy decision making process. Many researchers used fuzzy set theory in inventory control system. Sommer [16] applied fuzzy concept to inventory model. After that, Roy and Maiti [17] studied and solved a fuzzy EOQ model with demand dependent unit cost and limited storage capacity by GP and non-linear programming method. Mandal et al. [18] applied GP method to solve a multi-item inventory problem with three constraints under fuzzy environment. Again, Islam and Roy [19] proposed and solved a fuzzy production inventory model considering fuzziness in objective function, constraint goals and coefficients of the objective function and the constraint. Later on, Sadjadi et al. [20] suggested a pricing and marketing planning model where demand and cost function depend on price and marketing expenditure in imprecise environment and solved the problem by GP method.

In the case, where available information is not sufficient for the definition of an imprecise concept by means of a conventional fuzzy set, the concept of an Intuitionistic Fuzzy Set (IFS) can be viewed as an alternative approach to define a fuzzy set. The IFS may represent information more abundant and

flexible than the fuzzy set when uncertainty such as hesitancy degree is involved and hereby seems to be suitable for dealing with natural attributes of physical phenomena in complex management situations. The IFS uses two indexes, degree of membership and degree of non-membership, to describe the fuzziness. The degree of membership and degree of non-membership can be arbitrary satisfying the condition that the sum of the both is less than one.

The concept of IFS was introduced as a successful generalization of the fuzzy set by Atanassov [21]. Atanassov also analysed open problems in IFS theory in an explicit way. After that, Atanassov and Gargov [22] discussed interval valued IFS. Then Angelov [23] presented an optimization problem in intuitionistic fuzzy environment and solved the problem by converting into a crisp one. Pramanik and Roy [24–26] applied intuitionistic fuzzy goal programming approach to solve vector optimization problem, quality control problem and multi objective transportation problem respectively. After that, Pramanik et al. [27] investigated bilevel programming in intuitionistic environment. Later on, Jana and Roy [28] suggested a new intuitionistic fuzzy optimization approach for solving a multi objective intuitionistic fuzzy linear programming problem with equality and inequality constraints with intuitionistic fuzzy goals. They also discussed the application of this approach in transportation problems. After that, Banerjee and Roy [29] considered a stochastic inventory model with fuzzy cost components and solved by fuzzy GP and intuitionistic fuzzy GP techniques. Banerjee and Roy [30] also analysed and solved a stochastic inventory model with deterministic constraint by fuzzy GP and intuitionistic fuzzy GP method. A constrained multi objective inventory model of deteriorating items was solved under intuitionistic fuzzy environment by Mahapatra [31]. In recent era, Jafarian et al. [32] proposed a process to solve multi objective non-linear programming problem under intuitionistic environment using GP method.

The IFS can only handle incomplete information. In the case of indeterminate or inconsistent information the concept of IFS becomes insufficient. So, it cannot deal with all types of uncertainties in real life problems. In that case, Neutrosophic Set (NS) was introduced as a generalization of fuzzy set and IFS. In 1995, Smarandache [33–35] introduced the term 'Neutrosophy' which means knowledge of neutral thought. Neutrosophic is the derivative of neutrosophy and it includes neutrosophic set, neutrosophic probability, neutrosophic statistics, neutrosophic logic etc. NS is defined by three independent degrees; truth (membership) degree, indeterminacy (hesitation) degree and falsity (non-membership) degree. Here all the three degrees are standard or non-standard subsets of  $]0^-, 1^+[$ .

Nowadays, NS is used in different fields of research work. Roy and Das [36] solved multi objective production planning problem by neutrosophic linear programming approach. Banerjee et al. [37] discussed single objective linear goal programming problem in neutrosophic number environment. In recent era, Pramanik and Banerjee [38] formulated three new neutrosophic goal programming model to solve multi objective programming problems with neutrosophic number coefficients. Basset et al. [39, 40], S. Pramanik [41] analysed neutrosophic goal programming problem under neutrosophic sets environment. Again, a multi objective neutrosophic optimization technique is investigated and its application to structural design is developed by Sarker et al. [42]. Then Basset et al. [43] introduced and solved a neutrosophic linear programming model where the parameters are considered as trapezoidal neutrosophic numbers. Again, Basset et al. [44] represented a framework to estimate different cloud services by providing a neutrosophic multi-criteria decision analysis approach and developed a model depending on neutrosophic Analytic Hierarchy Process (AHP) using triangular neutrosophic numbers and estimated the quality of cloud services.

There are several papers on decision making using NS and Single Valued Neutrosophic Sets (SVNSs) environment. Basset et al. [45] discussed AHP decision making model under neutrosophic environment. Also, Basset et al. [46] extended AHP-SWOT analysis in neutrosophic environment. After that, NS was introduced for decision making and evaluation method to determine the factors influencing the selection of SCM suppliers by Basset et al. [47]. Basset et al. [48] also introduced a new neutrosophic association rule algorithm for big data analysis and discovered all of the possible association rules and minimized the losing processes of rules. Afterwards, Mondal and Pramanik [49, 50] explained neutrosophic decision making model for school choice and clay-brick selection respectively. The research field is then extended to neutrosophic Multi-Attribute Decision Making (MADM) process by some researchers. Biswas et al. [51] discussed neutrosophic MADM with unknown weight information. Again, Pramanik et al. [52] investigated the contribution of some Indian researchers to MADM in neutrosophic environment. Later on, Mondal and Pramanik [53] applied tangent similarity measure to neutrosophic MADM process. Ye and Zhang [54] established MADM with the help of similarity measures between SVNSs. After that, J. Ye [55] presented MADM model using a proposed form of correlation coefficient of SVNSs under neutrosophic environment. Recently, Mondal et al. [56] developed MADM process for SVNSs using similarity measures based on hyperbolic sine functions. Moreover, Multi-Criteria Decision Making (MCDM) approach is presented in neutrosophic environment by Zhang and Wu [57]. Mondal and Pramanik [58] extended Multi-Criteria Group Decision Making (MCGDM) approach in neutrosophic environment. Mondal et al. [59] used hybrid binary logarithm similarity measure to solve Multi-Attribute Group Decision Making (MAGDM) problem under SVNSs environment. Also, Biswas et al. [60] discussed MADM using entropy based grey relational analysis method under SVNSs environment. In recent era, Pramanik et al. [61] solved MAGDM problem using NS cross entropy.

Rough neutrosophic sets also have been used by several investigators to solve the decision making problems. Mondal et al. [62] discussed decision making process based on several trigonometric hamming similarity measures under rough neutrosophic environment. Recently, Pramanik et al. [63] used trigonometric hamming similarity measures to develop MADM model under rough neutrosophic environment. Also, Mondal et al. [64] presented MAGDM based on rough neutrosophic TOPSIS. Later on, the same authors extended MADM on rough neutrosophic variational coefficient similarity measure [65]. After that, Mondal and Pramanik [66] proposed tri-complex rough neutrosophic similarity measure and its applications in MADM. In recent era, Pramanik et al. [67, 68] discussed MCDM using projection and bidirectional projection measures and correlation coefficient under rough neutrosophic environment respectively. Again, Mondal and Pramanik [69] investigated decision making approach based on some similarity measure using interval rough neutrosophic sets. The same authors also discussed rough neutrosophic MADM using rough accuracy function [70]. Afterwards, Pramanik and Mondal [71] investigated rough neutrosophic similarity measures and MADM. Mondal and Pramanik [72] studied rough neutrosophic MADM based on grey relational analysis. Later on, Pramanik and Mondal [73, 74] used cotangent and cosine similarity measures under rough neutrosophic environment and its application in medical diagnosis. Later, Basset and Mohamed [75] proposed a general framework for dealing with imperfectness and incompleteness using single valued neutrosophic and rough set theories.

There are some developments on neutrosophic programming method which have been applied on some real life problems. Jiang and Ye [76] defined neutrosophic functions and numbers for optimization models. They formulated a two bar truss structure design problem and minimized its weight under stress and stability constraints using the neutrosophic number optimization method. Later, Ye [77] applied the neutrosophic number (NN) optimization method to a three bar planer truss structural design for minimum weight under stress and deflection constraints. Ye [78] and Ye et al. [79] developed neutrosophic number linear and non-linear programming methods respectively. In both cases, authors made applications under NN environment.

In spite of the above developments, there are several gaps in the literature of Neutrosophic Optimization. Till now, none has demonstrated that a non-linear Neutrosophic Optimization Problem can be reduced to a Geometric Programming Problem (GPP) with posynomial terms and solved by GP technique. Thus the motivation of the present investigation is to develop a procedure to reduce a non-linear Neutrosophic Problem to a corresponding GPP and then to solve it by the appropriate technique depending upon its degree of difficulty. Hence the main contributions of the present paper are the following.

- Representation of a non-linear Neutrosophic Programming Problem to a corresponding Geometric Programming Problem with posynomial terms.
- For illustration, a virgin non-linear inventory programming problem is formulated under neutrosophic environment.
- The said Neutrosophic Problem is reduced to a GPP with zero degree of difficulty.
- Reduced GPP is now solved by three methods-(i) Fuzzy Optimization technique, (ii) Intuitionistic Optimization method and (iii) Neutrosophic Optimization procedure.
- The superiority of Neutrosophic Optimization procedure is demonstrated with the help of some numerical data.

In this paper, we formulate an inventory model along with the space constraint. The holding cost has been taken as time dependent and the production cost has been taken as inversely related with set-up cost and production quantity. The constraint is considered here in neutrosophic environment. The inventory model is then converted into a crisp programming problem using additive operator and Neutrosophic Optimization Technique. Finally, it has been solved by GP method. Also a non-linear problem has been considered and solved proceeding the same procedure. At last, the numerical examples are considered to illustrate the problems.

This research paper is organized as follows. The introduction is described in Section 1. In Section 2, the basic definitions and operations are presented. Some notations and assumptions are made in Section 3. An inventory model is developed and solved in Section 4. The general form of Neutrosophic Non-linear Programming problem is given in Section 5. In Section 6, a solution procedure to solve Neutrosophic Non-linear Programming problem is described. Application of Neutrosophic Optimization Technique on a non-linear inventory model and a non-linear programming problem are illustrated in Section 7. In Section 8, the numerical experiments are presented. Discussion on numerical experiments is presented in Section 9. The conclusions and future research scope are described in Section 10.

## 2 Mathematical Preliminaries

### 2.1 Fuzzy Set [13]

Let  $X$  be a space of points (objects). A fuzzy set  $A$  in  $X$  is an object of the form  $A = \{(x, \mu_A(x)) : x \in X\}$  where  $\mu_A : X \rightarrow [0, 1]$  is called the membership function of the fuzzy set  $A$ .

### 2.2 Intuitionistic Fuzzy Set [21]

Let  $X$  denotes the universal set. An intuitionistic fuzzy set  $A$  in  $X$  is an object of the form  $A = \{(x, \mu_A(x), \nu_A(x)) : x \in X\}$  with the condition  $0 < \mu_A(x) + \nu_A(x) < 1 \forall x \in X$ . Here  $\mu_A, \nu_A : X \rightarrow [0, 1]$  define the membership function and the non-membership function for every element  $x$  in  $X$  respectively.

### 2.3 Neutrosophic Set [35]

Let the set  $X$  be a space of points (objects) and  $x \in X$ . A neutrosophic set  $A$  in  $X$  is defined by a truth (i.e., membership) function  $\mu_A(x)$ , an indeterminacy (i.e., hesitation) function  $\sigma_A(x)$  and a falsity (i.e., non-membership) function  $\nu_A(x)$  and having the form  $A = \{(x, \mu_A(x), \sigma_A(x), \nu_A(x)) : x \in X\}$ . Here  $\mu_A, \sigma_A, \nu_A : X \rightarrow ]0^-, 1^+[$ , that is,  $\mu_A, \sigma_A, \nu_A : X \rightarrow ]0^-, 1^+[$ . There is no restriction on the sum of  $\mu_A(x)$ ,  $\sigma_A(x)$  and  $\nu_A(x)$ , so  $0^- \leq \text{Sup } \mu_A(x) + \text{Sup } \sigma_A(x) + \text{Sup } \nu_A(x) \leq 3^+ \forall x \in X$ .

### 2.4 Single Valued Neutrosophic Set (SVNS) [33]

Let the set  $X$  be the universe of discourse. A single valued neutrosophic set  $A$  over  $X$  is an object having the form  $A = \{(x, \mu_A(x), \sigma_A(x), \nu_A(x)) : x \in X\}$ , where  $\mu_A, \sigma_A, \nu_A : X \rightarrow [0, 1]$  with the condition  $0 \leq \mu_A(x) + \sigma_A(x) + \nu_A(x) \leq 3 \forall x \in X$ .  $\mu_A(x)$ ,  $\sigma_A(x)$  and  $\nu_A(x)$  denote the truth degree, indeterminacy degree and falsity degree of the member  $x$  to  $A$  respectively.

### 2.5 Complement of SVNS [33]

The complement of a single valued neutrosophic set  $A$  is denoted by  $c(A)$  whose truth, indeterminacy and falsity functions are respectively given by

$$\begin{aligned}\mu_{c(A)}(x) &= \nu_A(x), \\ \sigma_{c(A)}(x) &= 1 - \sigma_A(x), \\ \nu_{c(A)}(x) &= \mu_A(x) \quad \text{for all } x \in X.\end{aligned}$$

### 2.6 Union of SVNS [33]

The union of two single valued neutrosophic sets  $A$  and  $B$  is a single valued neutrosophic set  $C$ , written as  $C = A \cup B$ , whose truth, indeterminacy and falsity functions are respectively given by

$$\begin{aligned}\mu_{A \cup B}(x) &= \max(\mu_A(x), \mu_B(x)), \\ \sigma_{A \cup B}(x) &= \max(\sigma_A(x), \sigma_B(x)), \\ \nu_{A \cup B}(x) &= \min(\nu_A(x), \nu_B(x)) \quad \text{for all } x \in X.\end{aligned}$$

### 2.7 Intersection of SVNS [33]

The intersection of two single valued neutrosophic sets  $A$  and  $B$  is a single valued neutrosophic set  $C$ , written as  $C = A \cap B$ , whose truth, indeterminacy and falsity functions are respectively given by

$$\begin{aligned}\mu_{A \cap B}(x) &= \min(\mu_A(x), \mu_B(x)), \\ \sigma_{A \cap B}(x) &= \min(\sigma_A(x), \sigma_B(x)), \\ \nu_{A \cap B}(x) &= \max(\nu_A(x), \nu_B(x)) \quad \text{for all } x \in X.\end{aligned}$$

## 3 Mathematical Model

An Inventory model is developed under the following notations and assumptions:



### 3.1 Notations

The inventory model is developed under the following notations:

- D: Demand per unit time (Decision variable).
- f(S,Q): Total production cost per cycle.
- H: Holding cost per unit item, which is time depended.
- I(t): Inventory level at any time,  $t \geq 0$ .
- Q: Production quantity per batch (Decision variable).
- S: Set-up cost per unit time (Decision variable).
- T: Cycle of length.
- TAC(D,S,Q): Total average cost per unit time.
- W: Total storage space area.
- $w_0$ : Space area per unit quantity.

### 3.2 Assumptions

Following assumptions have been considered in the model:

- a) The inventory system involves only one item.
- b) The replenishment occurs instantaneously at infinite rate.
- c) The lead time is negligible.
- d) Demand rate is constant.
- e) The total production cost is inversely related to set up cost(S) and production quantity(Q) i.e.,  $f(S, Q) = bS^{-x}Q^{-y}$ ,  $b, x, y \in R(> 0)$ .  
(It is a fact that modern machineries which may be costlier than the earlier ones perform better in terms of production rate, products' quality, etc. The cost of machineries are considered to a part of set up cost. As the high production rate reduces the unit price, set up cost may be considered to be inversely related to the production cost. Moreover, it is well known that when the quantities are procured in lot, the per unit cost reduces with the size of procured units, i.e., the production cost is inversely related with the procured amount.)
- f) In general, holding cost is assumed to be constant. But it is more realistic if we consider the holding cost increases with time, that is, it is time depended. Assume  $H = at$ .

## 4 Model Formation

In this model the inventory level gradually decreases to meet the demand (See Fig. 1). Therefore the differential equation describing I(t) at time t over the time period (0,T) is given by

$$\frac{dI(t)}{dt} = -D, \quad 0 \leq t \leq T \tag{1}$$

with the initial and boundary conditions  $I(0) = Q$  and  $I(T) = 0$ .

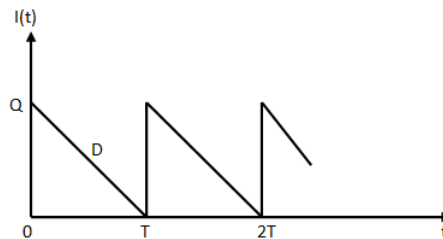

Figure 1: Crisp inventory model

The solution of the above differential equation is  $I(t) = Q - Dt$ .

Also we have,  $T = \frac{Q}{D}$

Inventory holding cost =  $\int_0^T H I(t) dt = \int_0^T at I(t) dt = \frac{aQ^3}{6D^2}$ .

Total inventory related cost per cycle = set up cost + holding cost + production cost =  $S + \frac{aQ^3}{6D^2} + f(S, Q)$

Total average cost per unit cycle is  $TAC(D, S, Q) = \frac{SD}{Q} + \frac{aQ^2}{6D} + \frac{bD}{S^x Q^{1+y}}$

There is a limitation on the available storage space area where the items are to be stored, i.e.,  $w_0Q \leq W$ . This restriction on available storage space in the inventory problem cannot be ignored to derive the optimal total cost.

Thus the primal problem for the inventory model can be written as:

$$\begin{aligned} \text{Min} \quad & TAC(D, S, Q) = \frac{SD}{Q} + \frac{aQ^2}{6D} + \frac{bD}{S^x Q^{1+y}} \\ \text{subject to} \quad & C(Q) \equiv w_0Q \leq W, \\ & D, S, Q > 0. \end{aligned} \tag{2}$$

The problem (2) is a constrained posynomial Primal Geometric Programming Problem (PGPP). Here Degree of Difficulty (DD) [It is defined as DD = total number of terms in objective and constraint functions - total number of decision variables - 1] for the problem = 4-3-1 =0.

Therefore the Dual Geometric Programming Problem (DGPP) of (2) is as follows:

$$\text{Max } d_c(w) = \left(\frac{1}{w_{01}}\right)^{w_{01}} \left(\frac{a}{6w_{02}}\right)^{w_{02}} \left(\frac{b}{w_{03}}\right)^{w_{03}} \left(\frac{w_0}{W}\right)^{w_{11}} \tag{3}$$

subject to the normality and orthogonality conditions

$$\begin{aligned} w_{01} + w_{02} + w_{03} &= 1, \\ w_{01} - w_{02} + w_{03} &= 0, \\ w_{01} - xw_{03} &= 0, \\ -w_{01} + 2w_{02} - (1 + y)w_{03} + w_{11} &= 0, \end{aligned}$$

and the positivity conditions are

$$w_{01}, w_{02}, w_{03}, w_{11} \geq 0$$

where  $w = (w_{01}, w_{02}, w_{03}, w_{11})^T$ .

Solving the above equations we get the dual variables and the dual objective function as given below:

$$w_{01}^* = \frac{x}{2(1+x)}, w_{02}^* = \frac{1}{2}, w_{03}^* = \frac{1}{2(1+x)}, w_{11}^* = \frac{y-x-1}{2(1+x)}, \text{ and } d_c^*(w^*) = \left(\frac{2a(x+1)}{3}\right)^{1/2} \left[\frac{b}{x^x} \left(\frac{w_0}{W}\right)^{y-x-1}\right]^{\frac{1}{2(1+x)}} \quad (4)$$

where  $w^* = (w_{01}^*, w_{02}^*, w_{03}^*, w_{11}^*)^T$ .

[Noted that from positivity conditions we have,  $x > 0$  and  $y > x + 1$ .]

Now primal-dual relations for obtaining the decision variables are

$$\frac{SD}{Q} = w_{01}^* d_c^*(w^*), \frac{aQ^2}{6D} = w_{02}^* d_c^*(w^*), \frac{bD}{S^x Q^{1+y}} = w_{03}^* d_c^*(w^*) \text{ and } \frac{w_0 Q}{W} = \frac{w_{11}^*}{w_{11}^*} \quad (5)$$

Solving the above equations (5), the optimum decision variables are obtained as follows:

$$D^* = \left(\frac{a}{6(x+1)}\right)^{1/2} \left[\frac{x^x}{b} \left(\frac{W}{w_0}\right)^{3x+y+3}\right]^{\frac{1}{2(1+x)}}, S^* = \left[bx \left(\frac{w_0}{W}\right)^y\right]^{\frac{1}{1+x}}, \text{ and } Q^* = \frac{W}{w_0}. \quad (6)$$

The corresponding optimal value of the cost function  $T_c^*(D^*, S^*, Q^*)$  is obtained as

$$T_c^*(D^*, S^*, Q^*) = \left(\frac{2a(x+1)}{3}\right)^{1/2} \left[\frac{b}{x^x} \left(\frac{w_0}{W}\right)^{y-x-1}\right]^{\frac{1}{2(1+x)}} \quad (7)$$

## 5 Neutrosophic Non-linear Programming

A non-linear programming problem can be written in the following general form:

$$\begin{aligned} \text{Min} \quad & f(x) \\ \text{subject to} \quad & g_j(x) \leq c_j, \quad (j = 1, 2, \dots, n) \\ & x \equiv (x_1, x_2, \dots, x_m)^T \geq 0. \end{aligned} \quad (8)$$

Usually the constraint goals are taken as fixed. But in real life one can find that the constraint goals may be imprecise. So let us take the constraint goal be at least  $c_j$  and the maximum allowable tolerance due to impreciseness be  $c_{1j}$  for the  $j^{th}$  constraint. For this fact the constraint goals are converted into neutrosophic constraint goals.

Thus the non-linear programming problem reduces to the following Neutrosophic Non-linear Programming (NNP) Problem:

$$\begin{aligned} \text{Min} \quad & f(x) \\ \text{subject to} \quad & g_j(x) \leq c_j \text{ with maximum allowable tolerance } c_{1j}, \quad (j = 1, 2, \dots, n) \\ & x \geq 0. \end{aligned} \quad (9)$$

## 6 Solution Procedure

### 6.1 Step I:

To solve the NNP problem (9) following Werner's Approach the problem is divided into two sub-problems; one sub-problem is considered without maximum allowable tolerance and another sub-problem is considered with maximum allowable tolerance in the constraints. Therefore the two sub-problems are as follows:

**Sub-problem I:**

$$\begin{aligned} \text{Min} \quad & f(x) \\ \text{subject to} \quad & g_j(x) \leq c_j, \quad (j = 1, 2, \dots, n) \\ & x \geq 0. \end{aligned} \quad (10)$$

**Sub-problem II:**

$$\begin{aligned} \text{Min} \quad & f(x) \\ \text{subject to} \quad & g_j(x) \leq c_j + c_{1j}, \quad (j = 1, 2, \dots, n) \\ & x \geq 0. \end{aligned} \quad (11)$$

Let the optimum solutions for the two sub-problems (10) and (11) be  $(x^{1*}, f(x^{1*}))$  and  $(x^{2*}, f(x^{2*}))$  respectively.

### 6.2 Step II:

For Neutrosophic Optimization Problem (NOP) problem we assume that  $U_{f(x)}^\mu, U_{f(x)}^\sigma, U_{f(x)}^\nu$  and  $L_{f(x)}^\mu, L_{f(x)}^\sigma, L_{f(x)}^\nu$  be the upper and lower bounds of the truth, indeterminacy and falsity functions for objective respectively.

Now we define those upper and lower bounds as follows:

$$\begin{aligned}
 U_{f(x)}^\mu &= \max\{f(x^{1*}), f(x^{2*})\}, & L_{f(x)}^\mu &= \min\{f(x^{1*}), f(x^{2*})\}, \\
 U_{f(x)}^\sigma &= L_{f(x)}^\mu + \delta_\sigma(U_{f(x)}^\mu - L_{f(x)}^\mu), & L_{f(x)}^\sigma &= L_{f(x)}^\mu, \\
 U_{f(x)}^\nu &= U_{f(x)}^\mu, & L_{f(x)}^\nu &= L_{f(x)}^\mu + \delta_\nu(U_{f(x)}^\mu - L_{f(x)}^\mu).
 \end{aligned}$$

where  $\delta_\sigma$  and  $\delta_\nu$  are predetermined real numbers in  $(0, 1)$ .

Similarly, for the  $j^{th}$  constraint let  $U_{g_j(x)}^\mu, U_{g_j(x)}^\sigma, U_{g_j(x)}^\nu$  and  $L_{g_j(x)}^\mu, L_{g_j(x)}^\sigma, L_{g_j(x)}^\nu$  be the upper and lower bounds of the truth, indeterminacy and falsity functions respectively. Then let us define them as

$$\begin{aligned}
 U_{g_j(x)}^\mu &= c_j + c_{1j}, & L_{g_j(x)}^\mu &= c_j, \\
 U_{g_j(x)}^\sigma &= L_{g_j(x)}^\mu + \epsilon_{\sigma j}, & L_{g_j(x)}^\sigma &= L_{g_j(x)}^\mu, \\
 U_{g_j(x)}^\nu &= U_{g_j(x)}^\mu, & L_{g_j(x)}^\nu &= L_{g_j(x)}^\mu + \epsilon_{\nu j}.
 \end{aligned}$$

where  $\epsilon_{\sigma j}$  and  $\epsilon_{\nu j}$  are predetermined real numbers in with  $0 \leq \epsilon_{\sigma j}, \epsilon_{\nu j} \leq c_{1j}, j = 1, 2, \dots, n$ .

### 6.3 Step III:

According to the assumptions given in step II the truth, indeterminacy and falsity functions for the objective are defined as follows (See Fig. 2):

$$\mu_{f(x)}(x) = \begin{cases} 1 & \text{if } f(x) \leq L_{f(x)}^\mu \\ \frac{U_{f(x)}^\mu - f(x)}{U_{f(x)}^\mu - L_{f(x)}^\mu} & \text{if } L_{f(x)}^\mu \leq f(x) \leq U_{f(x)}^\mu \\ 0 & \text{if } f(x) \geq U_{f(x)}^\mu \end{cases}$$

and

$$\sigma_{f(x)}(x) = \begin{cases} 1 & \text{if } f(x) \leq L_{f(x)}^\sigma \\ \frac{U_{f(x)}^\sigma - f(x)}{U_{f(x)}^\sigma - L_{f(x)}^\sigma} & \text{if } L_{f(x)}^\sigma \leq f(x) \leq U_{f(x)}^\sigma \\ 0 & \text{if } f(x) \geq U_{f(x)}^\sigma \end{cases}$$

and

$$\nu_{f(x)}(x) = \begin{cases} 0 & \text{if } f(x) \leq L_{f(x)}^\nu \\ \frac{f(x) - L_{f(x)}^\nu}{U_{f(x)}^\nu - L_{f(x)}^\nu} & \text{if } L_{f(x)}^\nu \leq f(x) \leq U_{f(x)}^\nu \\ 1 & \text{if } f(x) \geq U_{f(x)}^\nu \end{cases}$$

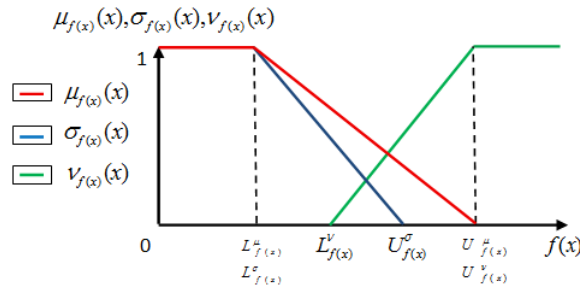

Figure 2: Rough sketch of truth, indeterminacy and falsity functions for objective function

Similarly, according to the assumptions the truth, indeterminacy and falsity functions for the  $j^{th}$  constraint are defined as follows (See Fig. 3):

$$\mu_{g_j(x)}(x) = \begin{cases} 1 & \text{if } g_j(x) \leq L_{g_j(x)}^\mu \\ \frac{U_{g_j(x)}^\mu - g_j(x)}{U_{g_j(x)}^\mu - L_{g_j(x)}^\mu} & \text{if } L_{g_j(x)}^\mu \leq g_j(x) \leq U_{g_j(x)}^\mu \\ 0 & \text{if } g_j(x) \geq U_{g_j(x)}^\mu \end{cases}$$

and

$$\sigma_{g_j(x)}(x) = \begin{cases} 1 & \text{if } g_j(x) \leq L_{g_j(x)}^\sigma \\ \frac{U_{g_j(x)}^\sigma - g_j(x)}{U_{g_j(x)}^\sigma - L_{g_j(x)}^\sigma} & \text{if } L_{g_j(x)}^\sigma \leq g_j(x) \leq U_{g_j(x)}^\sigma \\ 0 & \text{if } g_j(x) \geq U_{g_j(x)}^\sigma \end{cases}$$

and

$$\nu_{g_j(x)} = \begin{cases} 0 & \text{if } g_j(x) \leq L_{g_j}^\nu \\ \frac{g_j(x) - L_{g_j}^\nu}{U_{g_j}^\nu - L_{g_j}^\nu} & \text{if } L_{g_j}^\nu \leq g_j(x) \leq U_{g_j}^\nu \\ 1 & \text{if } g_j(x) \geq U_{g_j}^\nu \end{cases}$$

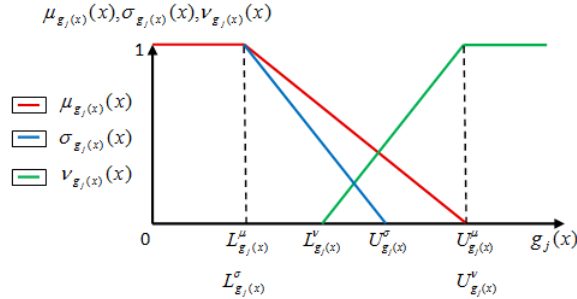

Figure 3: Rough sketch of truth, indeterminacy and falsity functions for  $j^{th}$  constraint

### 6.4 Step IV:

In Neutrosophic Optimization Technique the decision maker wants to maximize the degree of truth and to minimize the degree of indeterminacy and the degree of falsity of the objective and the constraints both. Therefore the NNP problem can be formulated in the following form:

$$\begin{aligned} \text{Max} \quad & \mu_{f(x)}(x), \mu_{g_1(x)}(x), \mu_{g_2(x)}(x), \dots, \mu_{g_n(x)}(x), \\ \text{min} \quad & \sigma_{f(x)}(x), \sigma_{g_1(x)}(x), \sigma_{g_2(x)}(x), \dots, \sigma_{g_n(x)}(x), \\ \text{min} \quad & \nu_{f(x)}(x), \nu_{g_1(x)}(x), \nu_{g_2(x)}(x), \dots, \nu_{g_n(x)}(x) \\ \text{subject to} \quad & \mu_{f(x)}(x) \geq \sigma_{f(x)}(x), \mu_{g_j(x)}(x) \geq \sigma_{g_j(x)}(x), \quad (j = 1, 2, \dots, n) \\ & \mu_{f(x)}(x) \geq \nu_{f(x)}(x), \mu_{g_j(x)}(x) \geq \nu_{g_j(x)}(x), \quad (j = 1, 2, \dots, n) \\ & \mu_{f(x)}(x), \sigma_{f(x)}(x), \nu_{f(x)}(x), \mu_{g_j(x)}(x), \sigma_{g_j(x)}(x), \nu_{g_j(x)}(x) \in [0, 1], \quad (j = 1, 2, \dots, n) \\ & x \geq 0. \end{aligned} \tag{12}$$

Based on weighted sum approach with equal weights the above problem reduces to the following crisp non-linear programming problem:

$$\begin{aligned} \text{Max} \quad & VFA(x) = \mu_{f(x)}(x) + \sum_{j=1}^n \mu_{g_j(x)}(x) - \sigma_{f(x)}(x) - \sum_{j=1}^n \sigma_{g_j(x)}(x) - \nu_{f(x)}(x) - \sum_{j=1}^n \nu_{g_j(x)}(x) \\ \text{subject to} \quad & \mu_{f(x)}(x) \geq \sigma_{f(x)}(x), \mu_{g_j(x)}(x) \geq \sigma_{g_j(x)}(x), \quad (j = 1, 2, \dots, n) \\ & \mu_{f(x)}(x) \geq \nu_{f(x)}(x), \mu_{g_j(x)}(x) \geq \nu_{g_j(x)}(x), \quad (j = 1, 2, \dots, n) \\ & \mu_{f(x)}(x), \sigma_{f(x)}(x), \nu_{f(x)}(x), \mu_{g_j(x)}(x), \sigma_{g_j(x)}(x), \nu_{g_j(x)}(x) \in [0, 1], \quad (j = 1, 2, \dots, n) \\ & x \geq 0. \end{aligned} \tag{13}$$

The above problem is equivalent to

$$\begin{aligned} \text{Max} \quad & VFA(x) = K - VFA_1(x) \\ \text{subject to} \quad & f(x) \in [L_f, U_f] \text{ and } g_j(x) \in [L_{g_j}, U_{g_j}], \quad (j = 1, 2, \dots, n) \\ & x > 0. \end{aligned} \tag{14}$$

where

$$L_f = \frac{U_{f(x)}^\mu L_{f(x)}^\sigma - U_{f(x)}^\sigma L_{f(x)}^\mu}{U_{f(x)}^\mu - L_{f(x)}^\mu - U_{f(x)}^\sigma + L_{f(x)}^\sigma}, \quad U_f = \frac{U_{f(x)}^\mu U_{f(x)}^\nu - L_{f(x)}^\mu L_{f(x)}^\sigma}{U_{f(x)}^\mu - L_{f(x)}^\mu + U_{f(x)}^\nu - L_{f(x)}^\sigma},$$

$$L_{g_j} = \frac{U_{g_j(x)}^\mu L_{g_j(x)}^\sigma - U_{g_j(x)}^\sigma L_{g_j(x)}^\mu}{U_{g_j(x)}^\mu - L_{g_j(x)}^\mu - U_{g_j(x)}^\sigma + L_{g_j(x)}^\sigma}, \quad U_{g_j} = \frac{U_{g_j(x)}^\mu U_{g_j(x)}^\nu - L_{g_j(x)}^\mu L_{g_j(x)}^\sigma}{U_{g_j(x)}^\mu - L_{g_j(x)}^\mu + U_{g_j(x)}^\nu - L_{g_j(x)}^\sigma}, \quad (j = 1, 2, \dots, n)$$

$$K = \frac{U_{f(x)}^\mu}{U_{f(x)}^\mu - L_{f(x)}^\mu} - \frac{U_{f(x)}^\sigma}{U_{f(x)}^\sigma - L_{f(x)}^\sigma} + \frac{L_{f(x)}^\nu}{U_{f(x)}^\nu - L_{f(x)}^\nu} + \sum_{j=1}^n \left[ \frac{U_{g_j(x)}^\mu}{U_{g_j(x)}^\mu - L_{g_j(x)}^\mu} - \frac{U_{g_j(x)}^\sigma}{U_{g_j(x)}^\sigma - L_{g_j(x)}^\sigma} + \frac{U_{g_j(x)}^\nu}{U_{g_j(x)}^\nu - L_{g_j(x)}^\nu} \right],$$

and

$$VF_{A1}(x) = \left[ \frac{f(x)}{U_{f(x)}^\mu - L_{f(x)}^\mu} - \frac{f(x)}{U_{f(x)}^\sigma - L_{f(x)}^\sigma} + \frac{f(x)}{U_{f(x)}^\nu - L_{f(x)}^\nu} \right] + \sum_{j=1}^n \left[ \frac{g_j(x)}{U_{g_j(x)}^\mu - L_{g_j(x)}^\mu} - \frac{g_j(x)}{U_{g_j(x)}^\sigma - L_{g_j(x)}^\sigma} + \frac{g_j(x)}{U_{g_j(x)}^\nu - L_{g_j(x)}^\nu} \right].$$

Now it is sufficient to solve the following crisp minimization problem

$$\text{Min } VF_{A1}(x) = \left[ \frac{f(x)}{U_{f(x)}^\mu - L_{f(x)}^\mu} - \frac{f(x)}{U_{f(x)}^\sigma - L_{f(x)}^\sigma} + \frac{f(x)}{U_{f(x)}^\nu - L_{f(x)}^\nu} \right] + \sum_{j=1}^n \left[ \frac{g_j(x)}{U_{g_j(x)}^\mu - L_{g_j(x)}^\mu} - \frac{g_j(x)}{U_{g_j(x)}^\sigma - L_{g_j(x)}^\sigma} + \frac{g_j(x)}{U_{g_j(x)}^\nu - L_{g_j(x)}^\nu} \right]$$

subject to the same restrictions as given in (14)

(15)

If  $f(x) = \sum_{k=1}^{P_0} C_{0k} \prod_{r=1}^m x_r^{a_{0kr}}$  and  $g_j(x) = \sum_{k=1+P_{j-1}}^{P_j} C_{jk} \prod_{r=1}^m x_r^{a_{jkr}}$

where  $C_{jk} > 0$  for  $k = 1, 2, \dots, P_j$ ;  $j = 0, 1, 2, \dots, n$  and  $a_{jkr}$  ( $k = 1, 2, \dots, 1 + P_{j-1}, \dots, P_j$ ;  $j = 0, 1, 2, \dots, n$ ;  $r = 1, 2, \dots, m$ ) are real numbers.

Then the problem can be taken as a crisp unconstrained posynomial PGPP with  $DD = \sum_{j=0}^n P_j - m - 1$ , provided that the optimal solution of  $f(x) \in [L_f, U_f]$  and that of  $g_j(x) \in [L_{g_j}, U_{g_j}]$ ,  $j = 1, 2, \dots, n$ .

## 7 Application of Neutrosophic Optimization Technique

### 7.1 An Inventory Model

Consider the inventory model (2) and assume that the storage area is flexible. Also assume that the maximum allowable tolerance be  $w_p$  due to impreciseness in the space constraint.

Therefore the inventory problem is converted into the NOP with flexible space constraint as given below:

$$\text{Min } TAC(D, S, Q) = \frac{SD}{Q} + \frac{aQ^2}{6D} + \frac{bD}{S^x Q^{1+y}}$$

subject to  $w_0 Q \leq W$  with maximum allowable tolerance  $w_p$ ,

$$D, S, Q > 0.$$

According to step I following Werner's Approach we first have to solve the following two sub-problems.

**Sub-problem I:**

$$\text{Min } TAC(D, S, Q) = \frac{SD}{Q} + \frac{aQ^2}{6D} + \frac{bD}{S^x Q^{1+y}}$$

subject to  $w_0 Q \leq W$ ,

$$D, S, Q > 0.$$

**Sub-problem II:**

$$\text{Min } TAC(D, S, Q) = \frac{SD}{Q} + \frac{aQ^2}{6D} + \frac{bD}{S^x Q^{1+y}}$$

subject to  $w_0 Q \leq W + w_p$ ,

$$D, S, Q > 0.$$

Solving (17) by GP method the optimum decision variables and the corresponding optimal objective  $T_1$  are obtained as:

$$D^* = \left( \frac{a}{6(x+1)} \right)^{1/2} \left[ \frac{x^x}{b} \left( \frac{W}{w_0} \right)^{3x+y+3} \right]^{\frac{1}{2(1+x)}}, \quad S^* = \left[ bx \left( \frac{w_0}{W} \right)^y \right]^{\frac{1}{1+x}}, \quad Q^* = \frac{W}{w_0},$$

and  $T_1 = \left( \frac{2a(x+1)}{3} \right)^{1/2} \left[ \frac{b}{x^x} \left( \frac{w_0}{W} \right)^{y-x-1} \right]^{\frac{1}{2(1+x)}}.$

Similarly, solving (18) by GP method the optimum decision variables and the corresponding optimal objective  $T_0$  are obtained as:

$$D^* = \left( \frac{a}{6(x+1)} \right)^{1/2} \left[ \frac{x^x}{b} \left( \frac{W + w_p}{w_0} \right)^{3x+y+3} \right]^{\frac{1}{2(1+x)}}, \quad S^* = \left[ bx \left( \frac{w_0}{W + w_p} \right)^y \right]^{\frac{1}{1+x}}, \quad Q^* = \frac{W + w_p}{w_0},$$

and  $T_0 = \left( \frac{2a(x+1)}{3} \right)^{1/2} \left[ \frac{b}{x^x} \left( \frac{w_0}{W + w_p} \right)^{y-x-1} \right]^{\frac{1}{2(1+x)}}.$

According to step II assume the upper and the lower bounds for the truth, indeterminacy and falsity functions for the objective respectively as given below:

$$\begin{aligned} U_T^\mu &= \max\{T_0, T_1\} = T_1, & L_T^\mu &= \min\{T_0, T_1\} = T_0, \\ U_T^\sigma &= T_0 + \delta_\sigma(T_1 - T_0), & L_T^\sigma &= T_0, \\ U_T^\nu &= T_1, & L_T^\nu &= T_0 + \delta_\nu(T_1 - T_0). \end{aligned}$$

where  $\delta_\sigma$  and  $\delta_\nu$  are predetermined real numbers in  $(0, 1)$ .

Similarly, the upper and the lower bounds for the truth, indeterminacy and falsity functions for the constraint are as follows:

$$\begin{aligned} U_C^\mu &= W + w_p, & L_C^\mu &= W, \\ U_C^\sigma &= W + \epsilon_\sigma, & L_C^\sigma &= W, \\ U_C^\nu &= W + w_p, & L_C^\nu &= W + \epsilon_\nu. \end{aligned}$$

where  $0 < \epsilon_\sigma, \epsilon_\nu < w_p$ .

Now let us write the truth, indeterminacy and falsity functions for the objective with the help of step III (See Fig. 4).

$$\mu_T(TAC(D, S, Q)) = \begin{cases} 1 & \text{if } TAC(D, S, Q) \leq T_0 \\ \frac{T_1 - TAC(D, S, Q)}{T_1 - T_0} & \text{if } T_0 \leq TAC(D, S, Q) \leq T_1 \\ 0 & \text{if } TAC(D, S, Q) \geq T_1 \end{cases} \quad (21)$$

and

$$\sigma_T(TAC(D, S, Q)) = \begin{cases} 1 & \text{if } TAC(D, S, Q) \leq T_0 \\ \frac{T_0 + \delta_\sigma(T_1 - T_0) - TAC(D, S, Q)}{\delta_\sigma(T_1 - T_0)} & \text{if } T_0 \leq TAC(D, S, Q) \leq T_0 + \delta_\sigma(T_1 - T_0) \\ 0 & \text{if } TAC(D, S, Q) \geq T_0 + \delta_\sigma(T_1 - T_0) \end{cases} \quad (22)$$

and

$$\nu_T(TAC(D, S, Q)) = \begin{cases} 0 & \text{if } TAC(D, S, Q) \leq T_0 + \delta_\nu(T_1 - T_0) \\ \frac{TAC(D, S, Q) - \{T_0 + \delta_\nu(T_1 - T_0)\}}{(T_1 - T_0)(1 - \delta_\nu)} & \text{if } T_0 + \delta_\nu(T_1 - T_0) \leq TAC(D, S, Q) \leq T_1 \\ 1 & \text{if } TAC(D, S, Q) \geq T_1 \end{cases} \quad (23)$$

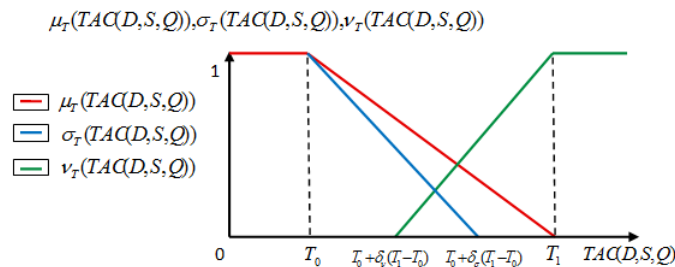

Figure 4: Rough sketch of truth, indeterminacy and falsity functions for objective function

In the same way, the truth, indeterminacy and falsity functions for the constraint are respectively as follows (See Fig. 5):

$$\mu_C(C(Q)) = \begin{cases} 1 & \text{if } C(Q) \leq W \\ \frac{W + w_p - C(Q)}{w_p} & \text{if } W \leq C(Q) \leq W + w_p \\ 0 & \text{if } C(Q) \geq W + w_p \end{cases} \quad (24)$$

and

$$\sigma_C(C(Q)) = \begin{cases} 1 & \text{if } C(Q) \leq W \\ \frac{W + \epsilon_\sigma - C(Q)}{\epsilon_\sigma} & \text{if } W \leq C(Q) \leq W + \epsilon_\sigma \\ 0 & \text{if } C(Q) \geq W + \epsilon_\sigma \end{cases} \quad (25)$$

and

$$\nu_C(C(Q)) = \begin{cases} 0 & \text{if } C(Q) \leq W + \epsilon_\nu \\ \frac{C(Q) - (W + \epsilon_\nu)}{w_p - \epsilon_\nu} & \text{if } W + \epsilon_\nu \leq C(Q) \leq W + w_p \\ 1 & \text{if } C(Q) \geq W + w_p \end{cases} \quad (26)$$

where  $0 < \epsilon_1, \epsilon_2 < w_p$ .

According to step IV the NOP can be written as an equivalent crisp non-linear programming problem as follows:

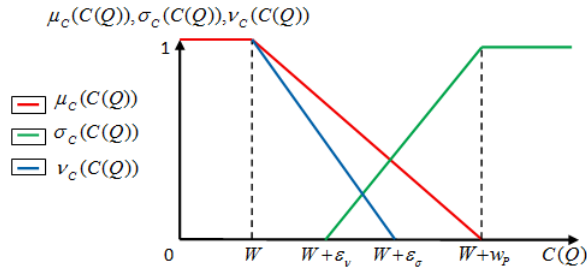

Figure 5: Rough sketch of truth, indeterminacy and falsity functions for constraint

**Sub-model I:**

$$\begin{aligned}
 \text{Max } VF_{A2}(D, S, Q) &= \mu_T(TAC(D, S, Q)) + \mu_C(C(Q)) - \sigma_T(TAC(D, S, Q)) - \sigma_C(C(Q)) - \nu_T(TAC(D, S, Q)) - \nu_C(C(Q)) \\
 \text{subject to } &\mu_T(TAC(D, S, Q)) \geq \sigma_T(TAC(D, S, Q)), \\
 &\mu_C(C(Q)) \geq \sigma_C(C(Q)), \\
 &\mu_T(TAC(D, S, Q)) \geq \nu_T(TAC(D, S, Q)), \\
 &\mu_C(C(Q)) \geq \nu_C(C(Q)), \\
 &\mu_T(TAC(D, S, Q)), \sigma_T(TAC(D, S, Q)), \nu_T(TAC(D, S, Q)), \\
 &\mu_C(C(Q)), \sigma_C(C(Q)), \nu_C(C(Q)) \in [0, 1], \\
 &D, S, Q > 0.
 \end{aligned} \tag{27}$$

Above non-linear programming problem can be reduced into the following unconstrained non-linear programming problem.

$$\begin{aligned}
 \text{Min } VF_{A3}(D, S, Q) &= K_1 \left( \frac{SD}{Q} + \frac{aQ^2}{6D} + \frac{bD}{S^x Q^{1+y}} \right) + K_2 Q \\
 \text{subject to } &D, S, Q > 0.
 \end{aligned} \tag{28}$$

provided that

$$TAC(D, S, Q) \in \left[ T_0, \frac{T_1 + (1 - \delta_\nu)T_0}{2 - \delta_\nu} \right] \quad \text{and} \quad Q \in \left[ \frac{W}{w_p}, \frac{W}{w_p} + \frac{w_p^2}{(2w_p - \epsilon_\nu)w_0} \right]. \tag{29}$$

$$\begin{aligned}
 \text{where } VF_{A2}(D, S, Q) &= \left( \frac{1}{T_1 - T_0} \right) \left( T_0 - \frac{T_0}{\delta_\sigma} + \frac{T_0 + \delta_\nu(T_1 - T_0)}{1 - \delta_\nu} \right) + \frac{W}{w_p} - \frac{W}{\epsilon_\sigma} + \frac{W + \epsilon_\nu}{w_p - \epsilon_\nu} - VF_{A3}(D, S, Q), \\
 K_1 &= \frac{1}{T_1 - T_0} \left[ 1 - \frac{1}{\delta_\sigma} + \frac{1}{1 - \delta_\nu} \right] \quad \text{and} \quad K_2 = \left[ \frac{w_0}{w_p} - \frac{w_0}{\epsilon_\sigma} + \frac{w_0}{w_p - \epsilon_\nu} \right].
 \end{aligned}$$

It is an unconstrained posynomial PGPP with DD = 0. Therefore the DGPP of (28) is as follows:

$$\text{Max } d_n(w) = \left( \frac{K_1}{w_{01}} \right)^{w_{01}} \left( \frac{aK_1}{6w_{02}} \right)^{w_{02}} \left( \frac{bK_1}{w_{03}} \right)^{w_{03}} \left( \frac{K_2}{w_{04}} \right)^{w_{04}}$$

subject to the normality and orthogonality conditions,

$$\begin{aligned}
 w_{01} + w_{02} + w_{03} &= 1, \\
 w_{01} - w_{02} &= 0, \\
 w_{01} - xw_{03} &= 0, \\
 -w_{01} + 2w_{02} - yw_{03} + w_{04} &= 0, \\
 w_{01}, w_{02}, w_{03}, w_{04} &\geq 0
 \end{aligned}$$

and the positivity conditions are where  $w = (w_{01}, w_{02}, w_{03}, w_{04})^T$ .

Solving the above equations we get the dual variables as,

$$w_{01}^* = \frac{x}{1 + x + y}, \quad w_{02}^* = \frac{1 + x}{1 + x + y}, \quad w_{03}^* = \frac{1}{1 + x + y}, \quad \text{and} \quad w_{04}^* = \frac{y - x - 1}{1 + x + y}. \tag{30}$$

Using the above values we get

$$d_n^*(w^*) = (1 + x + y) \left[ \left( \frac{a}{6(1 + x)} \right)^{1+x} K_1^{2+2x} \frac{b}{x^x} \left( \frac{K_2}{y - x - 1} \right)^{y-x-1} \right]^{\frac{1}{1+x+y}} \tag{31}$$

To find the decision variables, the primal dual relations are,

$$\frac{SDK_1}{Q} = w_{01}^* d_n^*(w^*), \quad \frac{aQ^2 K_1}{6D} = w_{02}^* d_n^*(w^*), \quad \frac{bDK_1}{S^x Q^{1+y}} = w_{03}^* d_n^*(w^*), \quad K_2 Q = w_{04}^* d_n^*(w^*). \tag{32}$$

By solving the above equations the optimum decision variables and the corresponding optimum objective function  $T_n^*(D^*, S^*, Q^*)$  are obtained as:

$$D^* = \left[ \left( \frac{a}{6(1+x)} \right)^{2+2x+y} \frac{b}{x^x} \left( \frac{K_1(y-x-1)}{K_2} \right)^{3x+y+3} \right]^{\frac{1}{1+x+y}}, \quad S^* = \left[ \left( \frac{6(1+x)}{a} \right)^y b x^{1+y} \left( \frac{K_2}{K_1(y-x-1)} \right)^{2y} \right]^{\frac{1}{1+x+y}},$$

$$Q^* = \left[ \left( \frac{a}{6(1+x)} \right)^{1+x} \frac{b}{x^x} \left( \frac{K_1(y-x-1)}{K_2} \right)^{2x+2} \right]^{\frac{1}{1+x+y}},$$

and  $T_n^*(D^*, S^*, Q^*) = \left[ x^{\frac{1-x+y}{1+x+y}} + (1+x) + 1 \right] \left[ \left( \frac{a}{6(1+x)} \right)^{1+x} \frac{b}{x^x} \left( \frac{K_1(y-x-1)}{K_2} \right)^{1+x-y} \right]^{\frac{1}{1+x+y}}.$  (33)

We know the fact that in case of neutrosophic set there is no restriction on truth function, indeterminacy function and falsity function other than they are subsets of  $]0^-, 1^+[$ , thus;  $0^- \leq Inf \mu + Inf \sigma + Inf \nu \leq Sup \mu + Sup \sigma + Sup \nu \leq 3^+$ .

In the Sub-model I, the indeterminacy function is taken as monotonically non increasing function like truth function. But one can define it as monotonically non decreasing function like falsity function also. In that case, the indeterminacy function for the objective and the constraint respectively will be defined as follows (See Fig. 6 and 7):

$$\sigma'_T(TAC(D, S, Q)) = \begin{cases} 0 & \text{if } TAC(D, S, Q) \leq T_0 + \delta_\sigma(T_1 - T_0) \\ \frac{TAC(D, S, Q) - (T_0 + \delta_\sigma(T_1 - T_0))}{(T_1 - T_0)(1 - \delta_\sigma)} & \text{if } T_0 + (T_1 - T_0)\delta_1 \leq TAC(D, S, Q) \leq T_1 \\ 1 & \text{if } TAC(D, S, Q) \geq T_1 \end{cases}$$
 (34)

and

$$\sigma'_C(C(Q)) = \begin{cases} 0 & \text{if } C(Q) \leq W + \epsilon_\sigma \\ \frac{C(Q) - (W + \epsilon_\sigma)}{w_p - \epsilon_\sigma} & \text{if } W + \epsilon_\sigma \leq C(Q) \leq W + w_p \\ 1 & \text{if } C(Q) \geq W + w_p \end{cases}$$
 (35)

where  $\delta_\sigma \in [0, 1]$  and  $0 < \epsilon_\delta < w_p$ .

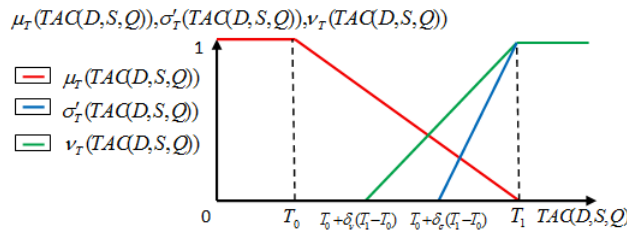

Figure 6: Rough sketch of truth, indeterminacy and falsity functions for objective in Sub-model II

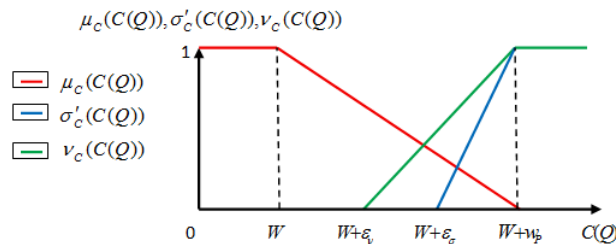

Figure 7: Rough sketch of truth, indeterminacy and falsity functions for constraint in Sub-model II

Now depending on the choice of indeterminacy function we can change the model formulation. If we take the indeterminacy functions as given in (34) and (35) and the truth and falsity functions as they are in Sub-model I, then after applying Neutrosophic Optimization technique the problem (16) reduces to the following crisp non-linear programming problem:



**Sub-model II:**

$$\begin{aligned}
\text{Max } VF_{AII}(D, S, Q) &= \mu_T(TAC(D, S, Q)) + \mu_C(C(Q)) - \sigma'_T(TAC(D, S, Q)) - \sigma'_C(C(Q)) - \nu_T(TAC(D, S, Q)) - \nu_C(C(Q)) \\
\text{subject to } \mu_T(TAC(D, S, Q)) &\geq \sigma'_T(TAC(D, S, Q)), \\
\mu_C(C(Q)) &\geq \sigma'_C(C(Q)), \\
\mu_T(TAC(D, S, Q)) &\geq \nu_T(TAC(D, S, Q)), \\
\mu_C(C(Q)) &\geq \nu_C(C(Q)), \\
\mu_T(TAC(D, S, Q)), \sigma'_T(TAC(D, S, Q)), \nu_T(TAC(D, S, Q)), \\
\mu_C(C(Q)), \sigma'_C(C(Q)), \nu_C(C(Q)) &\in [0, 1], \\
D, S, Q &> 0.
\end{aligned} \tag{36}$$

In this case also, required restrictions like (29) can be derived as before. Now this problem also can be solved by GP method as shown in Sub-model I.

In another case, one can take the indeterminacy function for the constraint as considered in (35) and consider the indeterminacy function for the objective and the truth and falsity functions for the objective and constraints both as shown in Sub-model I. In this case, we have

**Sub-model III:**

$$\begin{aligned}
\text{Max } VF_{AIII}(D, S, Q) &= \mu_T(TAC(D, S, Q)) + \mu_C(C(Q)) - \sigma_T(TAC(D, S, Q)) - \sigma'_C(C(Q)) - \nu_T(TAC(D, S, Q)) - \nu_C(C(Q)) \\
\text{subject to } \mu_T(TAC(D, S, Q)) &\geq \sigma_T(TAC(D, S, Q)), \\
\mu_C(C(Q)) &\geq \sigma'_C(C(Q)), \\
\mu_T(TAC(D, S, Q)) &\geq \nu_T(TAC(D, S, Q)), \\
\mu_C(C(Q)) &\geq \nu_C(C(Q)), \\
\mu_T(TAC(D, S, Q)), \sigma_T(TAC(D, S, Q)), \nu_T(TAC(D, S, Q)), \\
\mu_C(C(Q)), \sigma'_C(C(Q)), \nu_C(C(Q)) &\in [0, 1], \\
D, S, Q &> 0.
\end{aligned} \tag{37}$$

Similarly, one can take the indeterminacy function for the objective as given in (34). Now assume that the indeterminacy function for the constraint and the truth and falsity functions for objective and constraint both are same as in Sub-model I. In this case, the problem (16) reduces to

**Sub-model IV:**

$$\begin{aligned}
\text{Max } VF_{AIV}(D, S, Q) &= \mu_T(TAC(D, S, Q)) + \mu_C(C(Q)) - \sigma'_T(TAC(D, S, Q)) - \sigma_C(C(Q)) - \nu_T(TAC(D, S, Q)) - \nu_C(C(Q)) \\
\text{subject to } \mu_T(TAC(D, S, Q)) &\geq \sigma'_T(TAC(D, S, Q)), \\
\mu_C(C(Q)) &\geq \sigma_C(C(Q)), \\
\mu_T(TAC(D, S, Q)) &\geq \nu_T(TAC(D, S, Q)), \\
\mu_C(C(Q)) &\geq \nu_C(C(Q)), \\
\mu_T(TAC(D, S, Q)), \sigma'_T(TAC(D, S, Q)), \nu_T(TAC(D, S, Q)), \\
\mu_C(C(Q)), \sigma_C(C(Q)), \nu_C(C(Q)) &\in [0, 1], \\
D, S, Q &> 0.
\end{aligned} \tag{38}$$

In Sub-models III and IV, appropriate restrictions like (29) can be derived and they can also be solved proceeding the same solution procedure as in Sub-model I.

## 7.2 A Non-linear Problem

We consider the following non-linear problem with a constraint in neutrosophic environment:

$$\begin{aligned}
\text{Min } f(x, y, z) &= x^{-1}y^{-2}z^{-3} \\
\text{subject to } g(x, y, z) &\equiv x^3 + y^2 + z \leq 1 \text{ with maximum allowable tolerance } 0.5, \\
x, y, z &> 0.
\end{aligned} \tag{39}$$

Now proceeding as in 7.1, we get the following four Sub-models.

**Sub-model I:**

$$\begin{aligned}
\text{Min } f_I(x, y, z) &= K_I(x^{-1}y^{-2}z^{-3}) + K'_I(x^3 + y^2 + z) \\
\text{subject to } x, y, z &> 0.
\end{aligned} \tag{40}$$

where  $K_I = \frac{1}{f_1 - f_0} \left[ 1 - \frac{1}{\delta_\sigma} + \frac{1}{1 - \delta_\nu} \right]$  and  $K'_I = \left[ \frac{1}{0.5} - \frac{1}{\epsilon_\sigma} + \frac{1}{0.5 - \epsilon_\nu} \right]$ .

**Sub-model II:**

$$\begin{aligned}
\text{Min } f_{II}(x, y, z) &= K_{II}(x^{-1}y^{-2}z^{-3}) + K'_{II}(x^3 + y^2 + z) \\
\text{subject to } x, y, z &> 0.
\end{aligned} \tag{41}$$

where  $K_{II} = \frac{1}{f_1-f_0} \left[ 1 + \frac{1}{\delta_\sigma} + \frac{1}{1-\delta_\nu} \right]$  and  $K'_{II} = \left[ \frac{1}{0.5} + \frac{1}{\epsilon_\sigma} + \frac{1}{0.5-\epsilon_\nu} \right]$ .

**Sub-model III:**

$$\begin{aligned} \text{Min } f_{III}(x, y, z) &= K_{III}(x^{-1}y^{-2}z^{-3}) + K'_{III}(x^3 + y^2 + z) \\ \text{subject to } x, y, z &> 0. \end{aligned} \tag{42}$$

where  $K_{III} = \frac{1}{f_1-f_0} \left[ 1 + \frac{1}{1-\delta_\sigma} + \frac{1}{1-\delta_\nu} \right]$  and  $K'_{III} = \left[ \frac{1}{0.5} + \frac{1}{\epsilon_\sigma} + \frac{1}{0.5-\epsilon_\nu} \right]$ .

**Sub-model IV:**

$$\begin{aligned} \text{Min } f_{IV}(x, y, z) &= K_{IV}(x^{-1}y^{-2}z^{-3}) + K'_{IV}(x^3 + y^2 + z) \\ \text{subject to } x, y, z &> 0. \end{aligned} \tag{43}$$

where  $K_{IV} = \frac{1}{f_1-f_0} \left[ 1 - \frac{1}{\delta_\sigma} + \frac{1}{1-\delta_\nu} \right]$  and  $K'_{IV} = \left[ \frac{1}{0.5} + \frac{1}{0.5-\epsilon_\sigma} + \frac{1}{0.5-\epsilon_\nu} \right]$ .

## 8 Numerical Experiments

### 8.1 For Inventory Model 7.1

A manufacturing company produces machines in lots. The company has a warehouse with total floor area (W)= 1000 sq. ft. which is flexible upto ( $w_p$ )= 500 sq. ft. to store any excess spare parts, if necessary. The space area per unit quantity is ( $w_0$ )= 216 sq. ft. The production cost of the machine is related inversely with the set up (S) and the production quantity (Q). It is known from the past records that the production cost is  $5S^{-1}Q^{-3}$ . The holding cost per unit item is (H)= 21t.

The decision maker wants to determine the optimal values of demand (D), set-up cost (S), production quantity (Q) and the optimal total average cost  $TAC(D, S, Q)$ .

According to the input data, the problem (16) becomes

$$\begin{aligned} \text{Min } TAC(D, S, Q) &= \frac{SD}{Q} + \frac{21Q^2}{6D} + \frac{5D}{SQ^4} \\ \text{subject to } 216Q &\leq 1000 \text{ with maximum allowable tolerance } 500, \\ D, S, Q &> 0. \end{aligned} \tag{44}$$

The values of pre-assigned real numbers on the indeterminacy and falsity functions for objective and constraints are given in Table 1. The optimum results of the Sub-models i.e., Sub-model I, II, III and IV by Neutrosophic Optimization Technique are given in Table 2 and 3. Now we evaluate the optimum solutions of Sub-model I by different optimization techniques; Fuzzy Optimization Technique, Intuitionistic Optimization Technique [80] and Neutrosophic Optimization Technique and present the results in Table 4.

### 8.2 For Non-linear Problem 7.2

For this problem, the pre-assigned numbers for indeterminacy and falsity functions are assumed as shown in Table 1. The optimum solutions for all the Sub-models (Sub-model I, II, III and IV) by Neutrosophic Optimization Technique are described in Table 2 and 3. In Table 4, we express the optimum solutions of Sub-model I of problem 7.2 by different optimization techniques like Fuzzy Optimization Technique, Intuitionistic Optimization Technique [80] and Neutrosophic Optimization Technique.

Model/Problem	Indeterminacy function		Falsity function	
	Objective $\delta_\sigma$	Constraint $\epsilon_\sigma$	Objective $\delta_\nu$	Constraint $\epsilon_\nu$
Inventory Model 7.1	0.6	250	0.4	240
Non-linear Problem 7.2	0.6	0.3	0.4	0.1

Table 1: Values of pre-assigned numbers in indeterminacy and falsity functions

Model/Problem	Sub-models	Optimum dual variables				Optimum decision variables			Optimum objective function
		$w_{01}^*$	$w_{02}^*$	$w_{03}^*$	$w_{11}^*/w_{04}^*$	$S^*/x^*$	$D^*/y^*$	$Q^*/z^*$	
Inventory Model 7.1	Sub-problem I	0.25	0.50	0.25	0.25	0.22	27.81	4.3	$T_1 = 5.39$
	Sub-problem II	0.25	0.50	0.25	0.25	0.11	69.26	6.94	$T_0 = 4.87$
	Sub-model I	0.20	0.40	0.20	0.20	0.15	51.22	6.07	$T_n^*(D^*, S^*, Q^*) = 5.04$
Non-linear Problem 7.2	Sub-problem I	1.00	0.33	1.00	3.00	0.46	0.55	0.60	$f_1 = 19.95$
	Sub-problem II	1.00	0.33	1.00	3.00	0.53	0.67	0.90	$f_0 = 5.16$
	Sub-model I	0.19	0.06	0.19	0.56	0.51	0.64	0.82	$f^*(x^*, y^*, z^*) = 8.60$

Table 2: Optimal solution of Sub-model I

## 9 Discussion

### 9.1 Verification of restrictions

Here we verify the restrictions given in (29) using the result in Table 2.

Here  $T_0 = 4.87$ ,  $TAC_n^*(D^*, S^*, Q^*) = 5.04$  and  $\frac{T_1 + (1-\delta_\nu)T_0}{2-\delta_\nu} = 5.20$ . i.e.,  $TAC_n^*(D^*, S^*, Q^*) = 5.04 \in [4.87, 5.20]$ .

Model/Problem	Sub-models	Optimum decision variables			Optimum objective function
		$S^*/x^*$	$D^*/y^*$	$Q^*/z^*$	
Inventory Model 7.1	Sub-model II	0.15	48.41	5.93	5.07
	Sub-model III	1.13	2.52	1.59	7.04
	Sub-model IV	0.21	948.46	22.59	3.63
Non-linear Problem 7.2	Sub-model II	0.50	0.61	0.74	13.31
	Sub-model III	0.44	0.50	0.51	1.66
	Sub-model IV	0.58	0.77	1.20	69.91

Table 3: Optimum result of different Sub-models using Neutrosophic Optimization Technique

Model/Problem	Technique	Optimum decision variables			Optimum objective function
		$S^*/x^*$	$D^*/y^*$	$Q^*/z^*$	
Inventory Model 7.1	Fuzzy Optimization	0.16	44.39	5.70	5.12
	Intuitionistic Optimization	0.15	48.67	5.94	5.07
	Neutrosophic Optimization	0.15	51.22	6.07	5.04
Non-linear Problem 7.2	Fuzzy Optimization	0.49	0.60	0.72	14.72
	Intuitionistic Optimization	0.50	0.61	0.45	12.44
	Neutrosophic Optimization	0.51	0.64	0.82	8.60

Table 4: Optimal solution of Model 7.1 and Problem 7.2 using different optimization techniques

Also  $\frac{W}{w_0} = 4.63$ ,  $Q^* = 6.07$  and  $\frac{W}{w_0} + \frac{w_p^2}{(2w_p - \epsilon_\nu)w_0} = 6.15$  i.e.,  $Q^* = 6.07 \in [4.63, 6.15]$ .  
Similarly for other Sub-models, this type of verifications can be performed.

## 9.2 Comparison by different methods

Though the fuzzy, intuitionistic fuzzy and neutrosophic fuzzy environments are different, still from the Table 4 it is concluded that Neutrosophic Optimization Technique gives better optimum solution compared with the other techniques for these models.

## 9.3 Model with best optimum results

From Table 2 and 3, it is seen that, for the present model 7.1 and problem 7.2, the Sub-model I gives the best result. From this, it does not mean that always Sub-model I will give the best one. In other models, any of the four Sub-models may give the best results.

## 10 Conclusions

The main objective of this work is to illustrate how Neutrosophic Geometric Programming Technique can be utilized to solve a non-linear programming problem. The concept allows one to define the degree of truth, indeterminacy and falsity functions simultaneously. This research work also presents how to convert NNP into a crisp PGPP with the help of the above mentioned degrees and solve the problem.

In this paper, we have considered two examples- (i) an inventory model and (ii) a non-linear problem with space constraint under neutrosophic environment. From the numerical examples of these two problems, one can observe that Neutrosophic Optimization Technique has given better solution than Fuzzy Optimization and Intuitionistic Optimization Technique. The positive advantages of this technique is that it allows to imitate the real life situation more accurately and hence furnishes more useful solution to the management. This feature has been nicely illustrated in this paper. The limitation of the present investigation is that for illustration, we have restricted ourselves to the problem of GP type. Obviously, it limits the scope of modelling as GP problems demand posynomial expressions with zero degree of difficulty for less computation. However, the proposed method can be applied to any type of linear and non-linear optimization problems in the areas of supply chain management, portfolio management, etc. In the present problem, we have considered only one objective function. Present method can also be applied to multi-objective problems using any one of the available methods to convert multi-objective problem to a single objective one.

Thus, in future, this research work can be extended to develop Neutrosophic Geometric Programming Technique for solving several types of single objective and multi objective inventory models.

## 11 Acknowledgement

This research work is supported by Indian Institute of Engineering Science and Technology, Shibpur, Howrah. The first author sincerely acknowledges the contributions and is very grateful to them.

## References

- [1] T.C.E. Cheng. An economic order quantity model with demand-dependent unit cost. *European Journal of Operational Research*, 40(2):252–256, 1989.
- [2] T.C.E. Cheng. An economic order quantity model with demand-dependent unit production cost and imperfect production processes. *IIE Transactions*, 23(1):23–28, 1991.
- [3] H. Jung and C.M. Klein. Optimal inventory policies for an economic order quantity model with decreasing cost functions. *European Journal of Operational Research*, 165(1):108–126, 2005.
- [4] C. Zener. Engineering design by geometric programming. *Wiley, NewYork*. 1971.
- [5] R.J. Duffin, E.L. Peterson, and C.M. Zener. Geometric programming: Theory and application. *Wiley, NewYork*. 1967.

- [6] G.A. Kochenberger. Inventory models: Optimization by geometric programming. *Decision Sciences*, 2(2):193–205, 1971.
- [7] W.J. Lee. Determining order quantity and selling price by geometric programming: optimal solution, bounds and sensitivity. *Decision Sciences*, 24(1):76–87, 1993.
- [8] A.M.A. Hariri and M.A. El-Ata. Multi-item production lot-size inventory model with varying order cost under a restriction: A geometric programming approach. *Production Planning & Control*, 8(2):179–182, 1997.
- [9] H. Jung and C.M. Klein. Optimal inventory policies under decreasing cost functions via geometric programming. *European Journal of Operational Research*, 132(3):628–642, 2001.
- [10] N.K. Mandal, T.K. Roy and M. Maiti. Inventory model of deteriorated items with a constraint: A geometric programming approach. *European Journal of Operational Research*, 173(1):199–210, 2006.
- [11] K.N.F. Leung. A generalized geometric-programming solution to an economic production quantity model with flexibility and reliability considerations. *European Journal of Operational Research*, 176(1):240–251, 2007.
- [12] M.F. El-Wakeel, A. Salman and R. Suliman. Multi-product, multi-vendors inventory models with different cases of the rational function under linear and non-linear constraints via geometric programming approach. *Journal of King Saud University-Science*, 2008.
- [13] L.A. Zadeh. Fuzzy sets. *Information and Control*, 8:338–353, 1965.
- [14] R.E. Bellman and L.A. Zadeh. Decision-making in a fuzzy environment. *Management Science*, 17(4):141–164, 1970.
- [15] H.J. Zimmermann. Fuzzy programming and linear programming with several objective functions. *Fuzzy Sets and Systems*, 1(1):45–55, 1978.
- [16] G. Sommer. Fuzzy inventory scheduling. *Applied Systems and Cybernetics*, 5, 1981.
- [17] T.K. Roy and M. Maiti. A fuzzy EOQ model with demand-dependent unit cost under limited storage capacity. *European Journal of Operational Research*, 99(2):425–432, 1997.
- [18] N.K. Mandal, T.K. Roy and M. Maiti. Multi-objective fuzzy inventory model with three constraints: A geometric programming approach. *Fuzzy Sets and Systems*, 150(1):87–106, 2005.
- [19] S. Islam and T.K. Roy. A fuzzy EPQ model with flexibility and reliability consideration and demand dependent unit production cost under a space constraint: A fuzzy geometric programming approach. *Applied Mathematics and Computation*, 176(2):531–544, 2006.
- [20] S.J. Sadjadi, M. Ghazanfari and A. Yousefi. Fuzzy pricing and marketing planning model: A possibilistic geometric programming approach. *Expert Systems with Applications*, 37(4):3392–3397, 2010.
- [21] K.T. Atanassov. Intuitionistic fuzzy sets. *Studies in Fuzziness and Soft Computing*, 35, 1–137. Springer, 1999.
- [22] K. Atanassov and G. Gargov. Interval valued intuitionistic fuzzy sets. *Fuzzy Sets and Systems*, 31(3):343–349, 1989.
- [23] P.P. Angelov. Optimization in an intuitionistic fuzzy environment. *Fuzzy Sets and Systems*, 86(3):299–306, 1997.
- [24] S. Pramanik and T.K. Roy. An intuitionistic fuzzy goal programming approach to vector optimization problem. *Notes on Intuitionistic Fuzzy Sets*, 11(1):1–14, 2005.
- [25] S. Pramanik and T.K. Roy. An intuitionistic fuzzy goal programming approach for a quality control problem: a case study. *Tamsui Oxford Journal of Management Sciences*, 23(3):1–18, 2007.
- [26] S. Pramanik and T.K. Roy. Intuitionistic fuzzy goal programming and its application in solving multi-objective transportation problem. *Tamsui Oxford Journal of Management Sciences*, 23(1):1–17, 2007.
- [27] S. Pramanik, P.P. Dey and T.K. Roy. Bilevel programming in an intuitionistic fuzzy environment. *Journal of Technology*, XXXII:103–114, 2011.
- [28] B. Jana and T.K. Roy. Multi-objective intuitionistic fuzzy linear programming and its application in transportation model. *Notes on Intuitionistic Fuzzy Sets*, 13(1):34–51, 2007.
- [29] S. Banerjee and T.K. Roy. Application of fuzzy geometric and intuitionistic fuzzy geometric programming technique in the stochastic inventory model with fuzzy cost components. *Advances in Fuzzy Sets and Systems*, 6(2):121–152, 2010.
- [30] S. Banerjee and T.K. Roy. A constrained stochastic inventory model: Fuzzy geometric programming and intuitionistic fuzzy geometric programming approach. *International Journal of Computational Sciences and Mathematics*, 3(2):189–213, 2011.
- [31] N.K. Mahapatra. Multi-objective inventory model of deteriorating items with some constraints in an intuitionistic fuzzy environment. *International Journal of Physical and Social Sciences*, 2(9):342–363, 2012.
- [32] E. Jafarian, J. Razmi and M.F. Baki. A flexible programming approach based on intuitionistic fuzzy optimization and geometric programming for solving multi-objective nonlinear programming problems. *Expert Systems with Applications*, 93:245–256, 2018.
- [33] I. M. Hezam, M. Abdel-Baset and F. Smarandache. Taylor series approximation to solve neutrosophic multi-objective programming problem. *Infinite Study*, 2015.
- [34] F. Smarandache. A unifying field in logics: neutrosophic logic, neutrosophy, neutrosophic set, neutrosophic probability. *Infinite Study*, 2003.
- [35] F. Smarandache. Neutrosophic set—a generalization of the intuitionistic fuzzy set. *International Journal of Pure and Applied Mathematics*, 24(3):287, 2005.
- [36] R. Roy and P. Das. A multi-objective production planning problem based on neutrosophic linear programming approach. *Infinite Study*, 2015.
- [37] D. Banerjee and S. Pramanik. Single-objective linear goal programming problem with neutrosophic numbers. *International Journal of Engineering Science & Research Technology*, 7(5), 454–469.
- [38] S. Pramanik and D. Banerjee. Neutrosophic number goal programming for multi-objective linear programming problem in neutrosophic number environment. *MOJ Curr Res & Rev*, 1(3), 135–142, 2018.
- [39] M. Abdel-Baset, I.M. Hezam, and F. Smarandache. Neutrosophic goal programming. *Neutrosophic Sets & Systems*, 11, 2016.
- [40] I.M. Hezam, M. Abdel-Baset and F. Smarandache. Neutrosophic goal programming. *Infinite Study*, 2017.
- [41] S. Pramanik. Neutrosophic linear goal programming. *Global Journal of Engineering Science and Research Management*, 3(7), 01–11.
- [42] M. Sarkar, S. Dey and T.K. Roy. Multi-objective neutrosophic optimization technique and its application to structural design. *International Journal of Computer Applications*, vol. 148(12), 2016, pp. 31–37.

- [43] M. Abdel-Basset, M. Mohamed and F. Smarandache. A novel method for solving the fully neutrosophic linear programming problems, *Neural Computing and Applications*, 1-11.
- [44] M. Abdel-Basset, M. Mohamed and V. Chang. NMCDA: A framework for evaluating cloud computing services, *Future Generation Computer Systems*, 86, 2018, 12-29.
- [45] M. Abdel-Basset, M. Mohamed, Y. Zhou and I. Hezam. Multi-criteria group decision making based on neutrosophic analytic hierarchy process, *Journal of Intelligent & Fuzzy Systems*, 33(6), 4055-4066.
- [46] M. Abdel-Basset, M. Mohamed and F. Smarandache. An extension of neutrosophic AHP-SWOT analysis for strategic planning and decision-making, *Symmetry*, 10(4), 2018, pg-116.
- [47] M. Abdel-Basset, G. Manogaran, A. Gamal and F. Smarandache. A hybrid approach of neutrosophic sets and DEMATEL method for developing supplier selection criteria, *Design Automation for Embedded Systems*, 2018, 1-22.
- [48] M. Abdel-Basset, M. Mohamed, F. Smarandache and V. Chang. Neutrosophic association rule mining algorithm for big data analysis, *Symmetry*, 10(4), 2018, pg-106.
- [49] K. Mondal and S. Pramanik. Neutrosophic decision making model of school choice, *Neutrosophic Sets and Systems*, vol. 7, 2015, pp. 62-68.
- [50] K. Mondal and S. Pramanik. Neutrosophic decision making model for clay-brick selection in construction field based on grey relational analysis, *Neutrosophic Sets and Systems*, vol. 9, 2015, pp. 64-71.
- [51] P. Biswas, S. Pramanik and B.C. Giri. A new methodology for neutrosophic multi-attribute decision making with unknown weight information, *Neutrosophic Sets and Systems*, vol. 3, 2014, pp. 42-50.
- [52] S. Pramanik, R. Mallick and A. Dasgupta. Contributions of selected indian researchers to multi-attribute decision making in neutrosophic environment: An overview, *Neutrosophic Sets and Systems*, vol. 20, 2018, pp. 109-130.
- [53] K. Mondal and S. Pramanik. Neutrosophic tangent similarity measure and its application to multiple attribute decision making, *Neutrosophic Sets and Systems*, vol. 9, 2015, pp. 80-87.
- [54] J. Ye and Q. Zhang. Single valued neutrosophic similarity measures for multiple attribute decision-making, *Neutrosophic Sets and Systems*, vol. 2, 2014, pp. 48-54.
- [55] J. Ye. Another form of correlation coefficient between single valued neutrosophic sets and its multiple attribute decision making method, *Neutrosophic Sets and Systems*, Vol. 1, 2013, pp. 8-12.
- [56] K. Mondal, S. Pramanik and B.C. Giri. Single valued neutrosophic hyperbolic sine similarity measure based MADM strategy, *Neutrosophic Sets and Systems*, vol. 20, 2018, pp. 3-11.
- [57] Z. Zhang and C. Wu. A novel method for single-valued neutrosophic multi-criteria decision making with incomplete weight information, *Neutrosophic Sets and Systems*, vol. 4, 2014, pp. 35-49.
- [58] K. Mondal and S. Pramanik. Multi-criteria group decision making approach for teacher recruitment in higher education under simplified neutrosophic environment, *Neutrosophic Sets and Systems*, vol. 6, 2014, pp. 28-34.
- [59] K. Mondal, S. Pramanik and B.C. Giri. Hybrid binary logarithm similarity measure for MAGDM problems under SVNS assessments, *Neutrosophic Sets and Systems*, vol. 20, 2018, pp. 12-25.
- [60] P. Biswas, S. Pramanik and B.C. Giri. Entropy based grey relational analysis method for multi-attribute decision making under single valued neutrosophic assessments, *Neutrosophic Sets and Systems*, vol. 2, 2014, pp. 102-110.
- [61] S. Pramanik, S. Dalapati, S. Alam, F. Smarandache and T.K. Roy. NS-cross entropy-based MAGDM under single-valued neutrosophic set environment, *Information*, 2018, 9 (2), 37.
- [62] K. Mondal, S. Pramanik and F. Smarandache. Several trigonometric hamming similarity measures of rough neutrosophic sets and their applications in decision making, *New Trends in Neutrosophic Theory and Application*, 2016 (pp. 93-103).
- [63] S. Pramanik, R. Roy, T.K. Roy and F. Smarandache. Multi-attribute decision making based on several trigonometric hamming similarity measures under interval rough neutrosophic environment, *Neutrosophic Sets and Systems*, vol. 19, 2018, pp. 110-118.
- [64] K. Mondal, S. Pramanik and F. Smarandache. Rough neutrosophic TOPSIS for multi-attribute group decision making, *Neutrosophic Sets and Systems*, 2016, vol. 13, pp. 105-117.
- [65] K. Mondal, S. Pramanik and F. Smarandache. Multi-attribute decision making based on rough neutrosophic variational coefficient similarity measure, *Neutrosophic Sets and Systems*, 2016, vol. 13, pp. 3-17.
- [66] K. Mondal and S. Pramanik. Tri-complex rough neutrosophic similarity measure and its application in multi-attribute decision making, *Critical Review*, vol. 11, 2015, pp. 26-40.
- [67] S. Pramanik, R. Roy and T.K. Roy. Multi criteria decision making based on projection and bidirectional projection measures of rough neutrosophic sets, *Neutrosophic Sets and Systems*, vol. 19, 2018, pp. 101-109.
- [68] S. Pramanik, R. Roy, T.K. Roy and F. Smarandache. Multi criteria decision making using correlation coefficient under rough neutrosophic environment, *Neutrosophic Sets and Systems*, vol. 17, 2017, pp. 29-36.
- [69] K. Mondal and S. Pramanik. Decision making based on some similarity measures under interval rough neutrosophic environment, *Neutrosophic Sets and Systems*, vol. 10, 2015, pp. 46-57.
- [70] K. Mondal and S. Pramanik. Rough neutrosophic multi-attribute decision-making based on rough accuracy score function, *Neutrosophic Sets and Systems*, vol. 8, 2015, pp. 16-22.
- [71] S. Pramanik and K. Mondal. Some rough neutrosophic similarity measures and their application to multi attribute decision making, *Global Journal of Engineering Science and Research Management*, 2 (7), 2015, 61-74.
- [72] K. Mondal and S. Pramanik. Rough neutrosophic multi-attribute decision-making based on grey relational analysis, *Neutrosophic Sets and Systems*, vol. 7, 2015, pp. 8-17.
- [73] S. Pramanik and K. Mondal. Cotangent similarity measure of rough neutrosophic sets and its application to medical diagnosis, *Global Journal of Advanced Research*, 2(1), 2015, 212-220.

- [74] S. Pramanik and K. Mondal. Cosine similarity measure of rough neutrosophic sets and its application in medical diagnosis, *Journal of New Theory*, 4, 2015, 90-102.
- [75] M. Abdel-Basset and M. Mohamed. The role of single valued neutrosophic sets and rough sets in smart city: Imperfect and incomplete information systems, *Measurement*, vol-124, 2018, 47-55.
- [76] W. Ziang and J. Ye. Optimal design of truss structures using a neutrosophic number optimization model under an indeterminate environment, *New Mathematics and Natural Computation*, 2018.
- [77] J. Ye. An improved neutrosophic number optimization method for optimal design of truss structures, *Neutrosophic Sets and Systems*, 2016, 14: 93-97.
- [78] J. Ye. Neutrosophic number linear programming method and its application under neutrosophic number environments, *Soft Computing*, 2017.
- [79] J. Ye, W. Cui & Z. Lu. Neutrosophic number nonlinear programming problems and their general solution methods under neutrosophic number environments, *Axioms*, 2018, 7(1), 13; P. 1-9.
- [80] C. Kar and T.K Roy. An inventory model under space constraint in intuitionistic fuzzy environment: An intuitionistic fuzzy geometric programming approach. *To be communicate*.

Received: July 27, 2018. Accepted: August 20, 2018.



# Bi-level Linear Programming Problem with Neutrosophic Numbers

Surapati Pramanik<sup>1,\*</sup>, Partha Pratim Dey<sup>2</sup>

<sup>1</sup> Department of Mathematics, Nandalal Ghosh B.T. College, Panpur, P.O.-Narayanpur, District –North 24 Parganas, Pin code-743126, West Bengal, India. E-mail: sura\_pati@yahoo.co.in

<sup>2</sup> Department of Mathematics, Patipukur Pallisree Vidyapith, Patipukur, Kolkata-700048, West Bengal, India. E-mail: parsur.fuzz@gmail.com

\*Corresponding Author: sura\_pati@yahoo.co.in

**Abstract.** The paper presents a novel strategy for solving bi-level linear programming problem based on goal programming in neutrosophic numbers environment. Bi-level linear programming problem comprises of two levels namely upper or first level and lower or second level with one objective at each level. The objective function of each level decision maker and the system constraints are considered as linear functions with neutrosophic numbers of the form  $[p + q I]$ , where  $p, q$  are real numbers and  $I$  represents indeterminacy. In the decision making situation, we convert neutrosophic numbers into interval numbers and the original problem transforms into bi-level interval linear programming problem. Using interval programming technique, the target interval of the objective function of each level is identified and the goal achieving function is developed. Since, the objectives of upper and lower level decision makers are generally conflicting in nature, a possible relaxation on the decision variables under the control of each level is taken into account for avoiding decision deadlock. Then, three novel goal programming models are presented in neutrosophic numbers environment. Finally, a numerical problem is solved to demonstrate the feasibility, applicability and novelty of the proposed strategy.

**Keywords:** Neutrosophic set, neutrosophic number, bi-level linear programming, goal programming, preference bounds.

## 1 Introduction

Bi-level programming [1, 2, 3, 4] consists of the objective of the upper level decision maker (UDM) at its upper or first level and that of the lower level decision maker (LDM) at the lower or second level where every decision maker (DM) independently controls a set of decision variables. Candler and Townsley [3] as well as Fortuny-Amat and McCarl [4] were credited to develop the traditional bi-level programming problem (BLPP) in crisp environment. Using Stackelberg solution concept, Anandalingam [5] proposed a new solution procedure for multi-level programming problem (MLPP) and extended the concept to decentralized BLPP (DBLPP). After the introduction of fuzzy sets by L. A. Zadeh [6], many important methodologies have been proposed for solving MLPPs, and DBLPPs such as satisfactory solution concept [7], solution procedure based on non-compensatory max-min aggregation operator [8] and compensatory fuzzy operator [9], interactive fuzzy programming [10, 11], fuzzy mathematical programming [12, 13], fuzzy goal programming (FGP) [14], etc.

Goal programming (GP) [15-21] is an significant and widely used mathematical apparatus for dealing with multi-objective mathematical programming problems with numerous and often conflicting objectives in computing optimal compromise solutions. In 1991, Inuguchi and Kume [22] introduced interval GP. GP in fuzzy setting is called fuzzy goal programming (FGP), where unity (one) is the maximum (highest) aspiration level. In 1980, Narasimhan [23] incorporated the concept of FGP by using deviational variables. Mohamed [24] established the relation between GP and FGP and applied the concept to multi-objective programming problems. After its inception, FGP received much attention to the researchers and has been applied to solve BLPPs [25, 26, 27], multi-objective BLPPs [28], multi-objective decentralized BLPPs [29, 30], MLPPs [14, 31], multi-objective MLPPs [32, 33], fractional BLPP [34], multi-objective fractional BLPPs [35-39], decentralized fractional BLPP [40], fractional MLPPs [41], quadratic BLPPs [42, 43], multi-objective quadratic BLPP [44, 45], water quality management [46], project network [47], transportation [48, 49], etc.

GP in intuitionistic fuzzy environment [50] is termed as an intuitionistic fuzzy GP (IFGP). IFGP has been employed to vector optimization [51], transportation [52], quality control [53], bi-level programming [54], multi-objective optimization problems [55-57], etc.

In 1998, Smarandache [58] incorporated a new set in mathematical philosophy called neutrosophic sets to cope with inconsistent, incomplete, indeterminate information where indeterminacy is an independent and important factor and it plays a pivotal role in decision making. In 2010, Wang et al. [59] defined single valued neutrosophic set (SVNS) by simplifying neutrosophic set for practical applications. SVNS has been widely employed to decision making problems [60-75].

Smarandache [76] incorporated the idea of neutrosophic number (NN) and proved its fundamental properties. In 2015, Smarandache [77] also defined neutrosophic interval function (thick function). Jiang and Ye [78] provided basic definition of NNs and NN functions for optimization model for solving optimal design of truss structures. Pramanik et al. [79] presented teacher selection strategy based on bidirectional projection measure in neutrosophic number environment. Mondal et al. [80] proposed score and accuracy functions of NNs for ranking. NNs. In the same study, Modal et al. [80] defined neutrosophic number harmonic mean operator (NNHMO); Neutrosophic number weighted harmonic mean operator (NNWHMO) and proved thier basic properties. Mondal et al.[80] also developed two multi-attribute group decision making (MAGDM) startegies in NN environment.

Ye [81] proposed a neutrosophic number linear programming method for solving neutrosophic number optimization. Recently, Ye et al. [82] introduced some basic operations of NNs and concepts of NN nonlinear functions and inequalities and formulated a NN- nonlinear programming method.

Pramanik and Banerjee and [83] suggested a goal programming strategy for single-objective linear programming problem involving neutrosophic coefficients where the coefficients of objective functions and the system constraints are neutrosophic numbers of the form  $p + q I$ ,  $p, q$  are real numbers and  $I$  denotes indeterminacy. Pramanik and Banerjee [84] extended the concept of Pramanik and Banerjee [83] to develop goal programming strategy for multi-objective linear programming problem in neutrosophic number environment.

**Research gap:**

GP strategy for BLPP with neutrosophic numbers.

In order to fill the gap, we propose a novel strategy for BLPP through GP with neutrosophic numbers.

At the beginning, we convert the BLPP with neutrosophic numbers into interval BLPP by interval programming technique. Then, the goal achieving function is developed by defining target interval of the objective function of each level. A possible relaxation on the decision variables is considered for both level DMs to find the compromise optimal solution of the bi-level system. Then, three novel GP models are developed for BLPP in indeterminate environments. Finally, a BLPP is solved to demonstrate applicability and effectiveness of the developed strategy.

The remainder of the article is organized as follows: Section 2 presents some basic concepts regarding interval numbers, neutrosophic numbers. Section 3 provides the formulation of BLPP with neutrosophic numbers. GP strategy for BLPP with neutrosophic numbers is described in section 4. A numerical example is solved in the next section to show the proposed procedure. Finally, conclusions are given in the last section.

**2 Preliminaries**

In this section, we present several basic discussions concerning interval numbers and neutrosophic numbers

**2.1 Interval number [85]**

An interval number is represented by  $S = [S^L, S^U] = \{s: S^L \leq s \leq S^U, s \in \mathfrak{R}\}$ , where  $S^L, S^U$  are left and right limit of the interval  $S$  on the real line  $\mathfrak{R}$ .

**Definition 2.1:** Suppose  $m(S)$  and  $w(S)$  be the midpoint and the width of an interval number, respectively.

Then,  $m(S) = \frac{1}{2} [S^L + S^U]$  and  $w(S) = [S^U - S^L]$

The scalar multiplication of  $S$  by  $\alpha$  is represented as follows:

$$\alpha S = \begin{cases} [\alpha S^L, \alpha S^U], \alpha \geq 0, \\ [\alpha S^U, \alpha S^L], \alpha \leq 0 \end{cases}$$

The absolute value of  $S$  is defined as follows:

$$|S| = \begin{cases} [S^L, S^U], S^L \geq 0, \\ [0, \max\{-S^L, S^U\}], S^L < 0 < S^U \\ [-S^U, -S^L], S^U \leq 0 \end{cases}$$

The binary operation  $*$  between  $S_1 = [S_1^L, S_1^U]$  and  $S_2 = [S_2^L, S_2^U]$  is presented as given below.

$$S_1 * S_2 = \{s_1 * s_2: S_1^L \leq s_1 \leq S_1^U, S_2^L \leq s_2 \leq S_2^U, s_1, s_2 \in \mathfrak{R}\}.$$



### 2.2 Neutrosophic number [76]

A neutrosophic number is represented by  $N = p + q I$ , where  $p, q$  are real numbers where  $p$  is determinate part and  $q I$  is indeterminate part and  $I \in [I^L, I^U]$  denotes indeterminacy.

Therefore,  $N = [p + q I^L, p + q I^U] = [N^L, N^U]$ , (say)

**Example:** Suppose a neutrosophic number  $N = 1 + 2I$ , where 1 is determinate part and  $2 I$  is indeterminate part. Here, we consider  $I \in [0.3, 0.5]$ . Then,  $N$  becomes an interval number of the form  $N = [1.6, 2]$ .

Now, we present some properties of neutrosophic numbers as follows:

Consider,  $N_1 = [p_1 + q_1 I_1] = [p_1 + q_1 I_1^L, p_1 + q_1 I_1^U] = [N_1^L, N_1^U]$  and  $N_2 = [p_2 + q_2 I_2] = [p_2 + q_2 I_2^L, p_2 + q_2 I_2^U] = [N_2^L, N_2^U]$  be two neutrosophic numbers where  $I_1 \in [I_1^L, I_1^U], I_2 \in [I_2^L, I_2^U]$ , then

(i).  $N_1 + N_2 = [N_1^L + N_2^L, N_1^U + N_2^U]$ ,

(ii).  $N_1 - N_2 = [N_1^L - N_2^U, N_1^U - N_2^L]$ ,

(iii).  $N_1 \times N_2 = [\text{Min} \{ N_1^L \times N_2^L, N_1^L \times N_2^U, N_1^U \times N_2^L, N_1^U \times N_2^U \}, \text{Max} \{ N_1^L \times N_2^L, N_1^L \times N_2^U, N_1^U \times N_2^L, N_1^U \times N_2^U \}]$

(iv).  $N_1 / N_2 = [\text{Min} \{ N_1^L / N_2^L, N_1^L / N_2^U, N_1^U / N_2^L, N_1^U / N_2^U \}, \text{Max} \{ N_1^L / N_2^L, N_1^L / N_2^U, N_1^U / N_2^L, N_1^U / N_2^U \}]$ , if  $0 \notin N_2$ .

### 3 Formulation of BLPP for minimization-type objective function with neutrosophic numbers

We consider a BLPP for minimization-type objective function at each level. Mathematically, a BLPP with neutrosophic numbers can be presented as follows:

$$\text{UDM: } \underset{x_1}{\text{Min}} f_1(x) = [C_{11} + D_{11}I_{11}] x_1 + [C_{12} + D_{12} I_{12}] x_2 + [E_1 + F_1 I_{13}] \tag{1}$$

$$\text{LDM: } \underset{x_2}{\text{Min}} f_2(x) = [C_{21} + D_{21} I_{21}] x_1 + [C_{22} + D_{22} I_{22}] x_2 + [E_2 + F_2 I_{23}] \tag{2}$$

Subject to

$$x \in X = \{x = (x_1, x_2) \in R^N | [A_1 + B_1 I_1] x_1 + [A_2 + B_2 I_2] x_2 \leq \mu + \nu I_3, x \geq 0\}. \tag{3}$$

Here,  $x_1 = (x_{11}, x_{12}, \dots, x_{1N_1})^T$ : Decision vector under the control of UDM,

$x_2 = (x_{21}, x_{22}, \dots, x_{2N_2})^T$ : Decision vector under the control of LDM

$C_{i1}, D_{i1} (i = 1, 2)$  are  $N_1$ - dimension row vectors;  $C_{i2}, D_{i2} (i = 1, 2)$  are  $N_2$ - dimension row vectors where  $N = N_1 + N_2$ ; and  $E_i, F_i (i = 1, 2)$  are constants.  $A_i, B_i (i = 1, 2)$  are  $M \times N_i (i = 1, 2)$  constant matrix and  $\mu, \nu$  are  $M$  dimensional constant column matrix.  $X (\neq \Phi)$  is considered compact and convex in  $R^N$ . Also, we have  $I_{ij} \in [I_{ij}^L, I_{ij}^U], i = 1, 2, 3; j = 1, 2$  and  $I_i \in [I_i^L, I_i^U], i = 1, 2, 3$ . Representation of a BLPP is shown in Fig. 1.

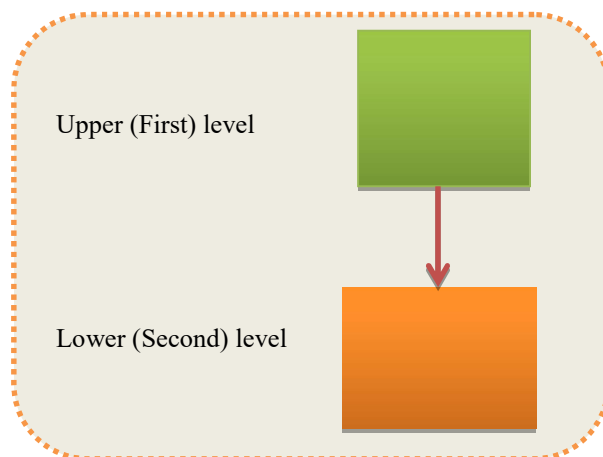

Fig. 1. Depiction of a BLPP

**4 Goal programming formulation for BLPP with neutrosophic numbers**

The objective functions of both level DMs of the problem defined in section 3 can be written as:

UDM:

$$\begin{aligned} \underset{x_1}{Min} f_1(x) &= [C_{11} + D_{11}I_{11}]x_1 + [C_{12} + D_{12}I_{12}]x_2 + [E_1 + F_1I_{13}] = \{[C_{11} + D_{11}I_{11}^L]x_1 + [C_{12} + D_{12}I_{12}^L]x_2 + [E_1 \\ &+ F_1I_{13}^L], [C_{11} + D_{11}I_{11}^U]x_1 + [C_{12} + D_{12}I_{12}^U]x_2 + [E_1 + F_1I_{13}^U]\} = [Y_1^L(x), Y_1^U(x)] \text{ (say);} \end{aligned} \tag{4}$$

LDM:

$$\begin{aligned} \underset{x_2}{Min} f_2(x) &= [C_{21} + D_{21}I_{21}]x_1 + [C_{22} + D_{22}I_{22}]x_2 + [E_2 + F_2I_{23}] = \{[C_{21} + D_{21}I_{21}^L]x_1 + [C_{22} + D_{22}I_{22}^L]x_2 + \\ &[E_2 + F_2I_{23}^L], [C_{21} + D_{21}I_{21}^U]x_1 + [C_{22} + D_{22}I_{22}^U]x_2 + [E_2 + F_2I_{23}^U]\} = [Y_2^L(x), Y_2^U(x)] \text{ (say);} \end{aligned} \tag{5}$$

and the system constrains reduce to

$$\begin{aligned} &[A_1 + B_1I_1]x_1 + [A_2 + B_2I_2]x_2 \geq \mu + \nu I_3 \\ \Rightarrow &\{[A_1 + B_1I_1^L]x_1 + [A_2 + B_2I_2^L]x_2, [A_1 + B_1I_1^U]x_1 + [A_2 + B_2I_2^U]x_2\} \geq [\mu + \nu I_3^L, \mu + \nu I_3^U] = [g^L, g^U] \\ \text{(say)} \\ \Rightarrow &[Z^L(x), Z^U(x)] \geq [g^L, g^U]. \end{aligned} \tag{6}$$

**Proposition 6 1. [86]**

Suppose  $\sum_{j=1}^n [e_1^j, e_2^j]z_j \geq [f_1, f_2]$ , then  $\sum_{j=1}^n [e_1^j]z_j \geq f_1, \sum_{j=1}^n [e_2^j]z_j \geq f_2$  are the maximum and minimum value range inequalities for the constraint condition, respectively.

Now, from the proposition 1 due to Shaocheng [86], the interval inequality of the system constraints (6) reduce to the following inequalities as given below.

$$[A_1 + B_1I_1^L]x_1 + [A_2 + B_2I_2^L]x_2 \geq g^U, [A_1 + B_1I_1^U]x_1 + [A_2 + B_2I_2^U]x_2 \geq g^L, x_i \geq 0, i = 1, 2,$$

i.e.  $Z^L(x) \geq g^U, Z^U(x) \geq g^L, x \geq 0$ .

The minimization-type BLPP can be re-stated as follows:

UDM:  $\underset{x_1}{Min} f_1(x) = [Y_1^L(x), Y_1^U(x)],$

LDM:  $\underset{x_2}{Min} f_2(x) = [Y_2^L(x), Y_2^U(x)]$

Subject to

$$[Z^L(x), Z^U(x)] \geq [g^L, g^U], x \geq 0.$$

For obtaining the best optimal solution of  $f_i, (i = 1, 2)$ , we solve the following problem due to Ramadan [87] as follows:

$$\underset{x \in X}{Min} f_i(x) = Y_i^L(x), i = 1, 2$$

$$Z^U(x) \geq g^L, x \geq 0, i = 1, 2.$$

Suppose  $x_i^b = (x_{i1}^b, x_{i2}^b, \dots, x_{iN_1}^b, x_{iN_1+1}^b, \dots, x_{iN}^b), (i = 1, 2)$  be the individual best solution of i-th level DM subject to the given constraints and  $Y_i^L(x_i^b), (i = 1, 2)$  be the individual best objective value of i-th level DM.

Now for determining the worst optimal solution of  $f_i, (i = 1, 2)$ , we solve the following problem due to Ramadan [85] as given below.

$$\underset{x \in X}{Min} f_i(x) = Y_i^U(x), i = 1, 2$$

$$Z^L(x) \geq g^U, x \geq 0.$$

Let  $x_i^w = (x_{i1}^w, x_{i2}^w, \dots, x_{iN_1}^w, x_{iN_1+1}^w, \dots, x_{iN}^w)$ , ( $i = 1, 2$ ) be the individual worst solution of  $i$ -th level DM subject to the given constraints and  $Y_i^U(x_i^w)$ , ( $i = 1, 2$ ) be the individual worst objective value of  $i$ -th level DM.

Therefore,  $[Y_i^L(x_i^b), Y_i^U(x_i^w)]$  be the optimal value of  $i$ -th level DM in the interval form.

Suppose that  $[Y_i^*, Y_i^+]$  be the target interval of  $i$ -th objective functions set by level DMs.

Now the target level of  $i$ -th objective function can be written as follows:

$$Y_i^U(x) \geq Y_i^*, (i = 1, 2)$$

$$Y_i^L(x) \leq Y_i^+, (i = 1, 2).$$

Hence, the goal achievement functions are presented in the following form:

$$-Y_i^U(x) + D_i^U = -Y_i^*, (i = 1, 2)$$

$$Y_i^L(x) + D_i^L = Y_i^+, (i = 1, 2)$$

where  $D_i^U, D_i^L$ , ( $i = 1, 2$ ) are deviational variables.

However, since the individual best solutions of the level DMs are not same, cooperation between the two level DMs is necessary to arrive at a compromise optimal solution. For more details see [27, 30, 31, 36, 37, 42, 44, 45, 55, 88].

Let,  $x_i^b = (x_{i1}^b, x_{i2}^b, \dots, x_{iN_1}^b, x_{iN_1+1}^b, \dots, x_{iN}^b)$ , ( $i = 1, 2$ ) be the individual best solution of  $i$ -th level DM. Suppose  $(x_{i1}^b - l_{i1})$  and  $(x_{i1}^b + u_{i1})$ , ( $i = 1, 2, \dots, N_1$ ) be the lower and upper bounds of decision vector provided by UDM where  $l_{i1}$  and  $u_{i1}$ , ( $i = 1, 2, \dots, N_1$ ) are the negative and positive tolerance variables which are not essentially same. Also, suppose that  $(x_{2i}^b - l_{2i})$  and  $(x_{2i}^b + u_{2i})$ , ( $i = 1, 2, \dots, N_2$ ) be the lower and upper bounds of decision vector provided by LDM where  $l_{2i}$  and  $u_{2i}$ , ( $i = 1, 2, \dots, N_2$ ) are the negative and positive tolerance variables which are not same in general. Therefore, we can write

$$(x_{i1}^b - l_{i1}) \leq x_{i1} \leq (x_{i1}^b + u_{i1}), (i = 1, 2, \dots, N_1)$$

$$(x_{2i}^b - l_{2i}) \leq x_{2i} \leq (x_{2i}^b + u_{2i}), (i = 1, 2, \dots, N_2)$$

Finally, we develop three new GP models (see the flowchart of GP model in Fig.2) for solving BLPP with neutrosophic numbers as follows:

#### GP Model I.

$$\text{Min } \sum_{i=1}^2 (D_i^U + D_i^L)$$

Subject to

$$-Y_i^U(x) + D_i^U = -Y_i^*, (i = 1, 2)$$

$$Y_i^L(x) + D_i^L = Y_i^+, (i = 1, 2)$$

$$Z^L(x) \geq g^U, Z^U(x) \geq g^L,$$

$$(x_{i1}^b - l_{i1}) \leq x_{i1} \leq (x_{i1}^b + u_{i1}), (i = 1, 2, \dots, N_1)$$

$$(x_{2i}^b - l_{2i}) \leq x_{2i} \leq (x_{2i}^b + u_{2i}), (i = 1, 2, \dots, N_2)$$

$$D_i^L, D_i^U, x \geq 0, (i = 1, 2).$$

#### GP Model II.

$$\text{Min } \sum_{i=1}^2 (w_i^U D_i^U + w_i^L D_i^L)$$

Subject to

$$-Y_i^U(x) + D_i^U = -Y_i^*, (i = 1, 2)$$

$$Y_i^L(x) + D_i^L = Y_i^+, (i = 1, 2)$$

$$Z^L(x) \geq g^U, Z^U(x) \geq g^L,$$

$$(x_{i1}^b - l_{i1}) \leq x_{i1} \leq (x_{i1}^b + u_{i1}), (i = 1, 2, \dots, N_1)$$

$$(x_{2i}^b - l_{2i}) \leq x_{2i} \leq (x_{2i}^b + u_{2i}), (i = 1, 2, \dots, N_2)$$

$$w_i^U \geq 0, w_i^L \geq 0, (i = 1, 2), D_i^L, D_i^U, x \geq 0, (i = 1, 2).$$

Here,  $w_i^U$  and  $w_i^L$  are the negative deviational variables.

**GP Model III.**

Min  $\alpha$

Subject to

$$-Y_i^U(x) + D_i^U = -Y_i^*, (i = 1, 2)$$

$$Y_i^L(x) + D_i^L = Y_i^+, (i = 1, 2)$$

$$Z^L(x) \geq g^U, Z^U(x) \geq g^L,$$

$$(x_{1i}^b - l_{1i}) \leq x_{1i} \leq (x_{1i}^b + u_{1i}), (i = 1, 2, \dots, N_1)$$

$$(x_{2i}^b - l_{2i}) \leq x_{2i} \leq (x_{2i}^b + u_{2i}), (i = 1, 2, \dots, N_2)$$

$$\alpha \geq D_i^U, \alpha \geq D_i^L, (i = 1, 2), D_i^L, D_i^U, x \geq 0, (i = 1, 2).$$

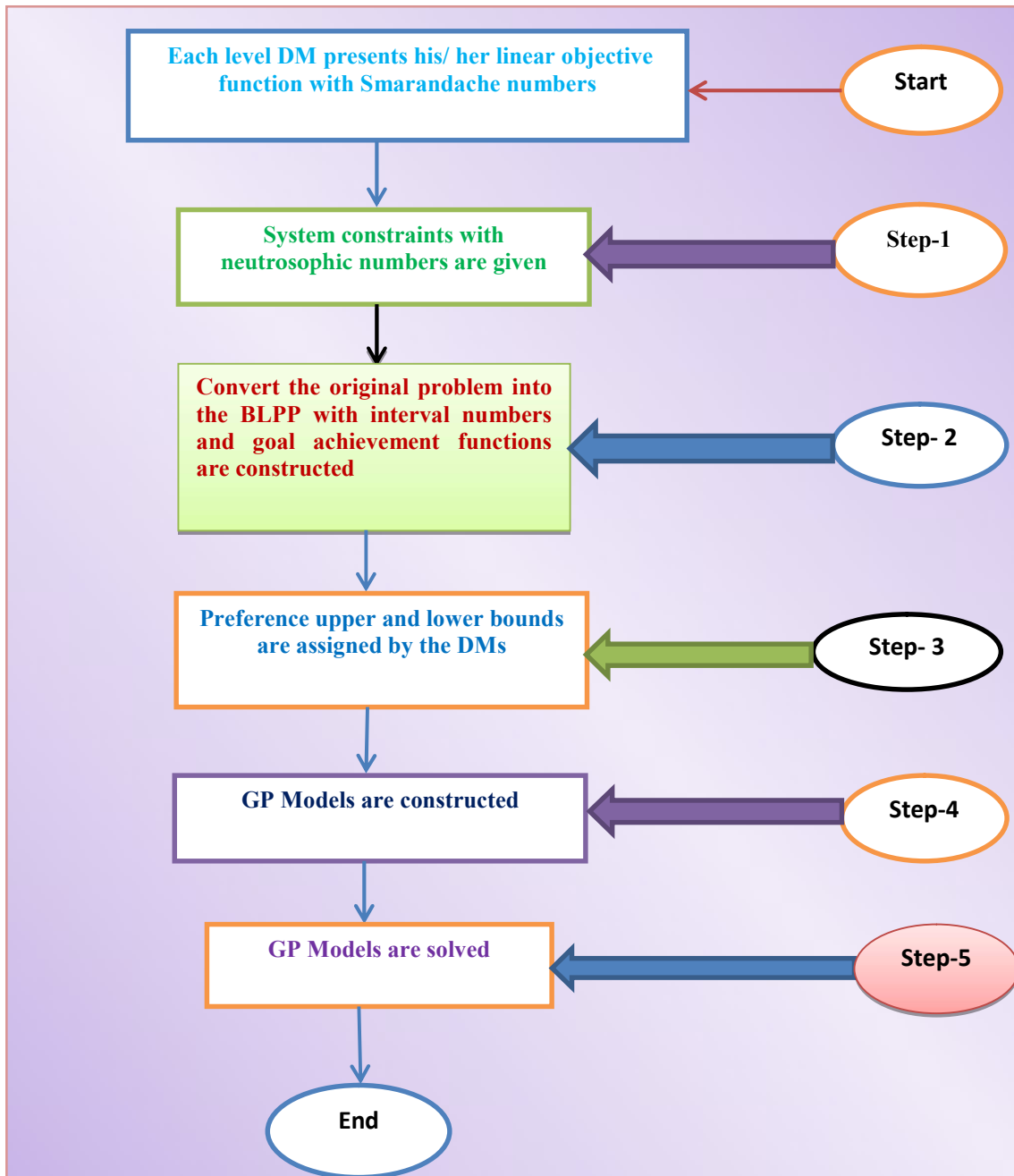

**Fig. 2.** Flowchart of the GP strategy for BLPP

**5 Numerical Example**

Consider the following BLPP with neutrosophic numbers to show the efficiency of the proposed strategy. We consider  $I \in [0, 1]$ .

UDM:  $Min_{x_1} f_1(x) = [1 + 2I] x_1 + [4 + 5I] x_2 + [1 + 2I]$ ,

LDM:  $Min_{x_1} f_1(x) = [3 + 4I] x_1 + [2 + 3I] x_2 + [3 + 2I]$ ,

Subject to

$[4 + 2I] x_1 + [3 + 7I] x_2 \geq [15 + 10I]$ ,

$[6 + I] x_1 + [-2 + 4I] x_2 \geq [5 + 3I]$ ,

$x_1, x_2 \geq 0$ .

The transformed problem of UDM is shown Table 1.

**Table 1.** UDM’s problem for best and worst solutions

UDM’s problem to find best solution	UDM’s problem to find worst solution
$Min Y_1^L(x) = x_1 + 4x_2 + 1$ Subject to $6 x_1 + 10 x_2 \geq 15,$ $7 x_1 + 2 x_2 \geq 5,$ $x_1, x_2 \geq 0.$	$Min Y_1^U(x) = 3x_1 + 9x_2 + 3$ Subject to $4 x_1 + 3x_2 \geq 25,$ $6 x_1 - 2 x_2 \geq 8,$ $x_1, x_2 \geq 0.$

The best and worst solutions of UDM are computed as given below (see Table 2)

**Table 2.** UDM’s best and worst solutions

The best solution of UDM	The worst solution of UDM
$Y_1^* = 3.5$ at $(2.5, 0)$	$Y_1^+ = 21.75$ at $(6.25, 0)$

The transformed problem of LDM can be presented as follows (see Table 3).

**Table 3.** LDM’s problem for best and worst solutions

LDM’s problem to find best solution	LDM’s problem to find worst solution
$Min Y_2^L(x) = 3x_1 + 2x_2 + 3$ Subject to $6 x_1 + 10 x_2 \geq 15,$ $7 x_1 + 2 x_2 \geq 5,$ $x_1, x_2 \geq 0.$	$Min Y_2^U(x) = 7x_1 + 5x_2 + 5$ Subject to $4 x_1 + 3x_2 \geq 25,$ $6 x_1 - 2 x_2 \geq 8,$ $x_1, x_2 \geq 0.$

The best and worst solutions of LDM are determined as given below (see Table 4)

**Table 4.** LDM’s best and worst solutions

The best solution of LDM	The worst solution of LDM
$Y_2^* = 6.621$ at $(0.345, 1.293)$	$Y_2^+ = 47.615$ at $(2.846, 4.538)$

The objective function of UDM with specified targets can be presented as given below.

$x_1 + 4x_2 + 1 \leq 21.5, 3x_1 + 9x_2 + 3 \geq 4,$

The goal achievement functions of UDM with specified targets can be presented as

$x_1 + 4x_2 + 1 + D_1^L = 21.5, -3x_1 - 9x_2 - 3 + D_1^U = -4,$

The objective function of LDM with specified targets can be presented as given below.

$3x_1 + 2x_2 + 3 \leq 47, 7x_1 + 5x_2 + 5 \geq 7,$

Also, the goal achievement functions of LDM with specified targets can be written as follows:

$3x_1 + 2x_2 + 3 + D_2^L = 47, -7x_1 - 5x_2 - 5 + D_2^U = -7.$

Suppose, the UDM provides preference bounds on the decision variable  $x_1$  as  $2.5 - 1.5 \leq x_1 \leq 2.5 + 2$  and the LDM offers preference bounds on the decision variable  $x_2$  as  $1.293 - 0.793 \leq x_2 \leq 1.293 + 1.207$  to reach optimal compromise solution.

Therefore, the GP models are developed as given below.

**GP Model I.**

$$\text{Min } (D_1^L + D_1^U + D_2^L + D_2^U)$$

Subject to

$$\begin{aligned} x_1 + 4x_2 + 1 + D_1^L &= 21.5, \\ -3x_1 - 9x_2 - 3 + D_1^U &= -4, \\ 3x_1 + 2x_2 + 3 + D_2^L &= 47, \\ -7x_1 - 5x_2 - 5 + D_2^U &= -7, \\ 6x_1 + 10x_2 &\geq 15, \\ 7x_1 + 2x_2 &\geq 5, \\ 4x_1 + 3x_2 &\geq 25, \\ 6x_1 - 2x_2 &\geq 8, \\ 2.5 - 1.5 &\leq x_1 \leq 2.5 + 2, \\ 1.293 - 0.793 &\leq x_2 \leq 1.293 + 1.207, \\ D_i^L, D_i^U &\geq 0, (i = 1, 2) \\ x_1, x_2 &\geq 0. \end{aligned}$$

**GP Model II.**

$$\text{Min } \frac{1}{4} (D_1^L + D_1^U + D_2^L + D_2^U)$$

Subject to

$$\begin{aligned} x_1 + 4x_2 + 1 + D_1^L &= 21.5, \\ -3x_1 - 9x_2 - 3 + D_1^U &= -4, \\ 3x_1 + 2x_2 + 3 + D_2^L &= 47, \\ -7x_1 - 5x_2 - 5 + D_2^U &= -7, \\ 6x_1 + 10x_2 &\geq 15, \\ 7x_1 + 2x_2 &\geq 5, \\ 4x_1 + 3x_2 &\geq 25, \\ 6x_1 - 2x_2 &\geq 8, \\ 2.5 - 1.5 &\leq x_1 \leq 2.5 + 2, \\ 1.293 - 0.793 &\leq x_2 \leq 1.293 + 1.207, \\ x_1, x_2 &\geq 0. \end{aligned}$$

**GP Model III.**

Min  $\alpha$

Subject to

$$\begin{aligned} x_1 + 4x_2 + 1 + D_1^L &= 21.5, \\ -3x_1 - 9x_2 - 3 + D_1^U &= -4, \\ 3x_1 + 2x_2 + 3 + D_2^L &= 47, \\ -7x_1 - 5x_2 - 5 + D_2^U &= -7, \\ 6x_1 + 10x_2 &\geq 15, \\ 7x_1 + 2x_2 &\geq 5, \\ 4x_1 + 3x_2 &\geq 25, \\ 6x_1 - 2x_2 &\geq 8, \\ 2.5 - 1.5 &\leq x_1 \leq 2.5 + 2, \\ 1.293 - 0.793 &\leq x_2 \leq 1.293 + 1.207, \\ \alpha &\geq D_i^L, \alpha \geq D_i^U, (i = 1, 2) \end{aligned}$$

$$D_i^L, D_i^U \geq 0, (i = 1, 2)$$

$$x_1, x_2 \geq 0.$$

The solutions of the proposed GP models are shown in the Table 5 as given below.

**Table 5.** The solutions of the BLPP

	Solution point	Objective values of UDM	Objective values of LDM
<b>GP Model I</b>	(4.5, 2.333)	[14.832, 37.497]	[21.166, 37.497]
<b>GP Model II</b>	(4.5, 2.333)	[14.832, 37.497]	[21.166, 37.497]
<b>GP Model III</b>	(4.375, 2.5)	[15.375, 38.625]	[21.125, 48.125]

## Conclusion

The paper presented three new goal programming models for bi-level linear programming problem where the objective functions of both level decision makers and the system constraints are linear functions with neutrosophic numbers. Using interval programming technique, we transform the bi-level linear programming problem into interval programming problem and calculated the best and the worst solutions for both level decision makers. Both decision makers assign preference upper and lower bounds on the decision variables under their control to obtain optimal compromise solution of the hierarchical organization. Finally, a new goal programming strategy has been developed to solve bi-level linear programming problem by minimizing deviational variables. We obtain the optimal compromise solution of the system in interval form which is more realistic. A numerical problem involving neutrosophic numbers is solved to demonstrate the applicability and efficiency of the proposed procedure.

We hope that the bi-level linear programming technique in neutrosophic number environment will open up a new avenue of research for future neutrosophic researchers. Furthermore, we believe that the proposed strategy can be effective for dealing with multi-objective bi-level linear programming, multi-objective decentralized bi-level linear programming, multi-objective decentralized multi-level linear programming, priority based multi-objective linear programming problems, real world decision making problems such as agriculture, bio-fuel production, portfolio selection, transportation, etc. with neutrosophic numbers information.

## References

- [1] J. F. Bard. Optimality conditions for the bi-level programming problem. *Naval Research Logistics Quarterly*, 31 (1984), 13-26.
- [2] W. F. Bialas, and M. H. Karwan. Two level linear programming. *Management Science*, 30 (1984), 1004-1020.
- [3] W. Candler, and R. Townsley. A linear bilevel programming problem. *Computers and Operations Research*, 9 (1982), 59 – 76.
- [4] J. Fortuni- Amat, and B. McCarl. A representation and economic interpretation of a two-level programming problem. *Journal of the Operational Research Society*, 32 (1981), 783-792.
- [5] G. Anandalingam. A mathematical programming model of decentralized multi-level systems. *Journal of the Operational Research Society*, 39 (11) (1988), 1021-1033.
- [6] L. A. Zadeh. Fuzzy sets. *Information and Control*, 8(3) (1965), 338-353.
- [7] Y. J. Lai. Hierarchical optimization: a satisfactory solution. *Fuzzy Sets and Systems*, 77 (3) (1996), 321–335.
- [8] H. S. Shih, Y. J. Lai, and E. S. Lee. Fuzzy approach for multi-level programming problems. *Computers and Operations Research*, 23(1) (1996), 73-91.
- [9] H. S. Shih, and E. S. Lee. Compensatory fuzzy multiple level decision making. *Fuzzy Sets and Systems*, 114(1) (2000), 71-87.
- [10] M. Sakawa, I. Nishizaki, and Y. Uemura. Interactive fuzzy programming for multilevel linear programming problems. *Computers and Mathematics with Applications*, 36 (2) (1998), 71-86.
- [11] M. Sakawa, and I. Nishizaki. Interactive fuzzy programming for decentralized two-level linear programming problems. *Fuzzy Sets and Systems*, 125 (3) (2002), 301-315.
- [12] S. Sinha. Fuzzy mathematical programming applied to multi-level programming problems. *Computers and Operations Research*, 30 (9) (2003), 1259 – 1268.
- [13] S. Sinha. Fuzzy programming approach to multi-level programming problems. *Fuzzy Sets and Systems*, 136 (2) (2003), 189 – 202.
- [14] S. Pramanik, and T. K. Roy. Fuzzy goal programming approach to multilevel programming problems. *European Journal of Operational Research*, 176 (2007), 1151-1166.
- [15] A. Charnes, W. W. Cooper. *Management models and industrial applications of linear programming*, Wiley, New York, 1961.

- [16] Y. Ijiri. Management goals and accounting for control, North-Holland Publication, Amsterdam, 1965.
- [17] S. M. Lee. Goal programming for decision analysis. Auerbach Publishers Inc., Philadelphia, 1972.
- [18] [18] J. P. Ignizio. Goal programming and extensions. Lexington Books, D. C. Heath and Company, London, 1976.
- [19] C. Romero. Handbook of critical issues in goal programming. Pergamon Press, Oxford, 1991.
- [20] M. J. Schrienderjans. Goal programming: Methodology and applications. Kluwer Academic Publishers, Boston, 1995.
- [21] C. T. Chang. Multi-choice goal programming. *Omega*, 35(4) (2007), 389-396.
- [22] M. Inuiguchi, and Y. Kume. Goal programming problems with interval coefficients and target intervals. *European Journal of Operational Research*, 52 (1991), 345-361.
- [23] R. Narasimhan. Goal programming in a fuzzy environment. *Decision Sciences*, 11 (2) (1980), 325-336.
- [24] R. H. Mohamed. The relationship between goal programming and fuzzy programming. *Fuzzy Sets and Systems*, 89 (2) (1997), 215 -222.
- [25] B. N. Moitra, and B. B. Pal. A fuzzy goal programming approach for solving bilevel programming problems, in: Pal, N. R. & Sugeno, M. (Eds.), AFSS 2002, INAI 2275, Springer-Verlag, Berlin, Heidelberg, pp.91-98 (2002).
- [26] S. R. Arora, and R. Gupta. Interactive fuzzy goal programming approach for bi-level programming problem. *European Journal of Operational Research*, 194 (2) (2009), 368-376.
- [27] S. Pramanik. Bilevel programming problem with fuzzy parameters: a fuzzy goal programming approach. *Journal of Applied Quantitative Methods*, 7(1) (2012), 9-24.
- [28] S. Pramanik, and P. P. Dey. Bi-level multi-objective programming problem with fuzzy parameters. *International Journal of Computer Applications*, 30(10) (2011), 13-20.
- [29] I. A. Baky. Fuzzy goal programming algorithm for solving decentralized bi-level multi-objective programming problems. *Fuzzy Sets and Systems*, 160(18) (2009), 2701-2713.
- [30] S. Pramanik, P. P. Dey, and B. C. Giri. Decentralized bilevel multiobjective programming problem with fuzzy parameters based on fuzzy goal programming. *Bulletin of Calcutta Mathematical Society*, 103(5) (2011), 381—390.
- [31] S. Pramanik. Multilevel programming problems with fuzzy parameters: a fuzzy goal programming approach. *International Journal of Computer Applications*, 122(21) (2015), 34-41.
- [32] I. A. Baky. Solving multi-level multi-objective linear programming problems through fuzzy goal programming approach. *Applied Mathematical Modelling*, 34 (9) (2010), 2377-2387.
- [33] N. Arbaiy, and J. Watada. Fuzzy goal programming for multi-level multi-objective problem: an additive model. *Software Engineering and Computer Systems Communication in Computer and Information Science*, 180 (2011), 81-95.
- [34] S. Pramanik, and P. P. Dey. Bi-level linear fractional programming problem based on fuzzy goal programming approach. *International Journal of Computer Applications*, 25 (11) (2011), 34-40.
- [35] M. A. Abo-Sinna, and I. A. Baky. Fuzzy goal programming procedure to bilevel multiobjective linear fraction programming problems. *International Journal of Mathematics and Mathematical Sciences*, (2010), 01-15, ID 148975 (2010) 01-15. doi: 10.1155/2010/148975.
- [36] P. P. Dey, S. Pramanik, and B. C. Giri. Fuzzy goal programming algorithm for solving bi-level multi-objective linear fractional programming problems. *International Journal of Mathematical Archive*, 4(8) (2013), 154-161.
- [37] P. P. Dey, S. Pramanik, and B.C. Giri. TOPSIS approach to linear fractional bi-level MODM problem based on fuzzy goal programming. *Journal of Industrial and Engineering International*, 10(4) (2014), 173-184.
- [38] K. C. Lachhwani. On fuzzy goal programming procedure to bi-level multiobjective linear fractional programming problems. *International Journal of Operational Research*, 28(3) (2017), 348-366.
- [39] S. Pramanik, I. Maiti, and T. Mandal. A Taylor series based fuzzy mathematical approach for multi objective linear fractional programming problem with fuzzy parameters. *International Journal of Computer Applications*, 180(45) (2018), 22-29.
- [40] S. Pramanik, P. P. Dey, and T. K. Roy. Fuzzy goal programming approach to linear fractional bilevel decentralized programming problem based on Taylor series approximation. *The Journal of Fuzzy Mathematics*, 20(1) (2012), 231- 238.
- [41] P. P. Dey, S. Pramanik, and B.C. Giri. Multilevel fractional programming problem based on fuzzy goal programming. *International Journal of Innovative Research in Technology & Science (IJIRTS)*, 2(4) (2014), 17-26.
- [42] B. B. Pal, and B. N. Moitra. A fuzzy goal programming procedure for solving quadratic bi-level programming problems. *International Journal of Intelligent Systems*, 18 (5) (2003), 529-540.
- [43] S. Pramanik, and P. P. Dey. Quadratic bi-level programming problem based on fuzzy goal programming approach. *International Journal of Software Engineering & Applications*, 2(4) (2011), 41-59.
- [44] S. Pramanik, P. P. Dey, and B. C. Giri. Fuzzy goal programming approach to quadratic bi-level multi-objective programming problem. *International Journal of Computer Applications*, 29(6) (2011), 09-14.
- [45] S. Pramanik, and D. Banerjee. Chance constrained quadratic bi-level programming problem. *International Journal of Modern Engineering Research*, 2(4) (2012), 2417-2424.
- [46] C. S. Lee, and C. G. Wen. Fuzzy goal programming approach for water quality management in a river basin. *Fuzzy Sets and Systems*, 89 (2) (1997), 181-192.
- [47] F. Arıkan, and Z. Güngör. An application of fuzzy goal programming to a multiobjective project network problem. *Fuzzy Sets and Systems*, 119 (1) (2001), 49-58.
- [48] S. Pramanik, and T. K. Roy. A fuzzy goal programming technique for solving multi-objective transportation problem. *Tamsui Oxford Journal of Management Sciences*, 22 (1) (2006), 67-77.
- [49] S. Pramanik, and D. Banerjee. Multi-objective chance constrained capacitated transportation problem based on fuzzy goal programming. *International Journal of Computer Applications*, 44(20) (2012), 42-46.
- [50] K. Atanassov. Intuitionistic fuzzy sets. *Fuzzy Sets and Systems*, 20 (1986), 87-96.



- [51] S. Pramanik, and T. K. Roy. An intuitionistic fuzzy goal programming approach to vector optimization problem. *Notes on Intuitionistic Fuzzy Sets*, 11(5) (2005), 01-14.
- [52] S. Pramanik, and T. K. Roy. Intuitionistic fuzzy goal programming and its application in solving multi-objective transportation problem. *Tamsui Oxford Journal of Management Sciences*, 23(1) (2007), 01-17.
- [53] S. Pramanik, and T. K. Roy. An intuitionistic fuzzy goal programming approach for a quality control problem: a case study. *Tamsui Oxford Journal of Management Sciences*, 23 (3) (2007), 01-18.
- [54] S. Pramanik, P. P. Dey, and T. K. Roy. Bilevel programming in an intuitionistic fuzzy environment. *Journal of Technology*, XXXXII (2011), 103-114.
- [55] S. Dey, and T. K. Roy. Intuitionistic fuzzy goal programming technique for solving non-linear multi-objective structural problem. *Journal of Fuzzy Set Valued Analysis*, 2015(3) (2015), 179-193.
- [56] J. Razmi, E. Jafarian, and S. H. Amin. An intuitionistic fuzzy goal programming approach for finding Pareto-optimal solutions to multi-objective programming problems. *Expert Systems with Applications*, 65 (2016), 181-193. DOI: 10.1016/j.eswa.2016.08.048.
- [57] S. Rukmani, and R. S. Porchelvi. Goal programming approach to solve multi-objective intuitionistic fuzzy non-linear programming models. *International Journal of Mathematics Trends and Technology*, 53(7) (2018), 505-514.
- [58] F. Smarandache. A unifying field of logics. *Neutrosophy: Neutrosophic probability, set and logic*. American Research Press, Rehoboth, 1998.
- [59] H. Wang, F. Smarandache, Y. Q. Zhang, and R. Sunderraman. Single valued neutrosophic sets. *Multispace & Multistructure*, 4 (2010), 410-413.
- [60] P. Biswas, S. Pramanik, and B. C. Giri. Entropy based grey relational analysis method for multi-attribute decision making under single valued neutrosophic assessments. *Neutrosophic Sets and Systems* 2(2014), 102-110.
- [61] P. Biswas, S. Pramanik, and B. C. Giri. A new methodology for neutrosophic multi-attribute decision making with unknown weight information. *Neutrosophic Sets and Systems* 3 (2014), 42-52.
- [62] K. Mondal, S. Pramanik. Multi-criteria group decision making approach for teacher recruitment in higher education under simplified neutrosophic environment. *Neutrosophic Sets and Systems*, 6 (2014), 28-34.
- [63] K. Mondal, and S. Pramanik. Neutrosophic decision making model of school choice. *Neutrosophic Sets and Systems*, 7(2015), 62-68.
- [64] P. Biswas, S. Pramanik, and B. C. Giri. Cosine similarity measure based multi-attribute decision-making with trapezoidal fuzzy neutrosophic numbers. *Neutrosophic Sets Systems*, 8 (2015), 47-57.
- [65] K. Mondal, S. Pramanik. Neutrosophic tangent similarity measure and its application to multiple attribute decision making. *Neutrosophic Sets Systems*, 9 (2015), 80-87.
- [66] P. Biswas, S. Pramanik, and B. C. Giri. Aggregation of triangular fuzzy neutrosophic set information and its application to multi-attribute decision making. *Neutrosophic Sets and Systems*, 12 (2016), 20-40.
- [67] P. Biswas, S. Pramanik, and B. C. Giri. Value and ambiguity index based ranking method of single-valued trapezoidal neutrosophic numbers and its application to multi-attribute decision making. *Neutrosophic Sets and Systems* 12 (2016), 127-138.
- [68] P. Biswas, S. Pramanik, and B. C. Giri. TOPSIS method for multi-attribute group decision-making under single-valued neutrosophic environment. *Neural Computing and Applications*, 27(3) (2016), 727-737.
- [69] S. Pramanik, S. Dalapati, and T. K. Roy. Logistics center location selection approach based on neutrosophic multi-criteria decision making. In F. Smarandache, & S. Pramanik (Eds), *New trends in neutrosophic theory and applications*. Pons Editions, Brussels, 2016, 161-174.
- [70] P. Biswas, S. Pramanik, and B. C. Giri. Multi-attribute group decision making based on expected value of neutrosophic trapezoidal numbers. *New Trends in Neutrosophic Theory and Applications-Vol-II*. Pons Editions, Brussels (2017). In Press.
- [71] P. Biswas, S. Pramanik, and B. C. Giri. Multi-attribute group decision making based on expected value of neutrosophic trapezoidal numbers. *New Trends in Neutrosophic Theory and Applications-Vol-II*. Pons Editions, Brussels (2017). In Press.
- [72] S. Pramanik, P. Biswas, and B. C. Giri. Hybrid vector similarity measures and their applications to multi-attribute decision making under neutrosophic environment. *Neural Computing and Applications*, 28 (2017), 1163-1176.
- [73] K. Mondal, S. Pramanik, and B. C. Giri. Single valued neutrosophic hyperbolic sine similarity measure based strategy for MADM problems. *Neutrosophic Sets and Systems*, 20 (2018), 3-11.
- [74] K. Mondal, S. Pramanik, and B. C. Giri. Hybrid binary logarithm similarity measure for MAGDM problems under SVNS assessments. *Neutrosophic Sets and Systems*, 20 (2018), 12-25.
- [75] S. Pramanik, S. Dalapati, S. Alam, F. Smarandache, T. K. Roy. NS-cross entropy-based MAGDM under single-valued neutrosophic set environment. *Information*, 9(2) (2018), 37; doi:10.3390/info9020037
- [76] F. Smarandache. *Introduction of neutrosophic statistics*. Sitech and Education Publisher, Craiova, 2013.
- [77] F. Smarandache. *Neutrosophic precalculus and neutrosophic calculus*. Europa-Nova, Brussels, 2015.
- [78] W. Jiang, and J. Ye. Optimal design of truss structures using a neutrosophic number optimization model under an indeterminate environment. *Neutrosophic Sets and Systems*, 15 (2017), 8-17.
- [79] K. Mondal, S. Pramanik, B. C. Giri, and F. Smarandache. NN-harmonic mean aggregation operators-based MCGDM strategy in a neutrosophic number environment. *Axioms* 7 (1), doi:10.3390/axioms7010012
- [80] S. Pramanik, R. Roy, and T.K. Roy. Teacher selection strategy based on bidirectional projection measure in neutrosophic number environment. In *Neutrosophic Operational Research*; Smarandache, F., Abdel-Basset, M., El-Henawy, I., Eds.; Pons Publishing House / Pons asbl: Bruxelles, Belgium, 2017; Volume 2, pp. 29-53. ISBN 978-1-59973-537-5.

- [81] J. Ye. Neutrosophic number linear programming method and its application under neutrosophic number environment. *Soft Computing*, (2017). doi: 10.1007/s00500-017-2646-z.
- [82] J. Ye, W. Cai, and Z. Lu, Neutrosophic number non-linear programming problems and their general solution methods under neutrosophic number environment. *Axioms*, 7(1) (2018). doi:10.3390/axioms7010013.
- [83] D. Banerjee, and S. Pramanik. Single-objective linear goal programming problem with neutrosophic numbers. *International Journal of Engineering Science & Research Technology*, 7(5) (2018), 454-469.
- [84] S. Pramanik, and D. Banerjee. Neutrosophic number goal programming for multi-objective linear programming problem in neutrosophic number environment. *MOJ Current Research & Review*, 1(3) (2018), 135-141.
- [85] R. E. Moore. *Interval analysis*, Prentice-Hall, New Jersey, 1998.
- [86] T. Shaocheng. Interval number and fuzzy number linear programming. *Fuzzy Sets and Systems*, 66(3) (1994), 301-306.
- [87] K. Ramadan. *Linear programming with interval coefficients* Doctoral dissertation, Carleton University, 1996.
- [88] P. P. Dey, and S. Pramanik. Goal programming approach to linear fractional bilevel programming problem based on Taylor series approximation. *International Journal of Pure and Applied Sciences and Technology*, 6(2) (2011), 115-123.

Received: July 30, 2018. Accepted: August 22, 2018.



# Single Valued Neutrosophic Numbers and Analytic Hierarchy Process for Project Selection

Milton Villegas Alava<sup>3</sup>, Stella Paola Delgado Figueroa<sup>2</sup>, Hilda Mercedes Blum Alcivar<sup>3</sup>, Maikel Leyva Vázquez<sup>4</sup>

<sup>1</sup>Universidad de Guayaquil, Facultad de Ciencias Administrativas, Guayaquil Ecuador. E-mail: milton.villegasa@ug.edu.ec

<sup>2</sup>Universidad de Politécnica Salesiana, Sede Guayaquil, Facultad de Administración de Empresas, Guayaquil Ecuador. E-mail: sdelgadof@ups.edu.ec

<sup>3</sup>Universidad de Guayaquil, Facultad de Ciencias Administrativas, Guayaquil Ecuador. E-mail: hilda.bluma@ug.edu.ec

<sup>4</sup>Universidad de Guayaquil, Facultad de Ciencias Matemáticas y Físicas, Guayaquil Ecuador. E-mail: mleyvaz@gmail.com

**Abstract.** Neutrosophic sets and its application to decision support have become a topic of great importance. In this paper, a new model for decision making in the selection of projects is presented based on single valued neutrosophic number (SVN-numbers) and the analytic hierarchy process (AHP). The proposed framework is composed of five activities, framework, criteria weighting, gathering information, rating alternatives and project selection. Project alternatives are rated based on aggregation operator and the ranking of alternatives is based on scoring and accuracy functions. The AHP method is included and allows a correct weighting of different criteria involved. Additionally the common decision resolution scheme for helping decision maker to reach a reliable decision is used giving methodological support t. A case study is developed showing the applicability of the proposal for information technologies project selection. Further works will concentrate in extending the proposal for group decision making and developing a software tool.

**Keywords:** Decision Analysis, SVN Numbers, analytic hierarchy process, project selection.

..

## 1 Introduction

Fuzzy logic or multi-valued logic is based on fuzzy set theory proposed by Zadeh [1], for helping in modeling knowledge in a more natural way. The basic idea is the notion of the membership relation which takes truth values in the closed interval of real numbers  $[0, 1]$  [2].

The intuitionistic fuzzy set (IFS) on a universe was introduced by K. Atanassov as a generalization of fuzzy sets [3]. In IFS besides the degree of membership ( $\mu_A(x) \in [0,1]$ ) of each element  $x \in X$  to a set A there was considered a degree of non-membership  $\nu_A(x) \in [0,1]$ , such that:

$$\forall x \in X \mu_A(x) + \nu_A(x) \leq 1 \quad (1)$$

Later the neutrosophic set (NS) was introduced by F. Smarandache who introduced the degree of indeterminacy (i) as independent component [4].

Decision analysis is a discipline with the goal of computing an overall assessment that summarizes the information gathered and providing useful information about each evaluated element [5]. In real world decision making problems uncertainty is presented and the use of linguistic information to model and manage such an uncertainty is recommended [6].

Experts feel more comfortable providing their knowledge by using terms close to the way human beings use [7] by means of linguistic variables. A linguistic variable is a variable whose values are words or sentences in a natural or artificial language [8].

Because of the imprecise nature of the linguistic assessments new techniques have been developed. Single valued neutrosophic sets (SVNS) [9] for handling indeterminate and inconsistent information is a relatively new approach. In this paper a new model of project selection is developed based on single valued neutrosophic number (SVN-number) allowing the use of linguistic variables [10, 11] and the analytical hierarchy process (AHP)

for weighting criteria according to its importance [12]. Weighting criteria is important in decision making problems. In some similar proposals weight are given but no method is explained [13] or [14]. Additionally the common decision resolution scheme for helping decision maker to reach a reliable decision is used giving solid methodological support.

This paper is structured as follows: Section 2 reviews some preliminaries concepts about decision analysis framework SVN numbers and AHP method to find the attributes weight. In Section 3, a decision analysis framework based on SVN numbers for project selection. Section 4 shows a case study of the proposed model. The paper ends with conclusions and further work recommendations.

## 2 Preliminaries

In this section, we first provide a brief revision of a general decision scheme, the use of linguistic information using SVN numbers project selection and the Analytic Hierarchy Process.

### 2.1 Decision Scheme

Decision analysis is a discipline with the purpose of helping decision maker to reach a reliable decision.

A common decision resolution scheme consists of following phases [6, 15]:

- Identify decision and objectives.
- Identify alternatives.
- Framework:
- Gathering information.
- Rating alternatives.
- Choosing the alternative/s:
- Sensitive analysis
- Make a decision

Inside the framework phase, the structures and elements of the decision problem are defined. Experts provides information, according to the defined framework.

The gathered information provided by experts is then aggregated in the rating phase to obtain a collective value of alternatives. In rating phase, it is necessary to carry out a solving process to compute the collective assessments for the set of alternatives, using aggregation operators [16].

Aggregation operator are important in decision making. Aggregation operator,  $\mathcal{C}$ [17], are function with the following form::

$$\mathcal{C}: \mathbb{N}^n \rightarrow \mathbb{N} \tag{2}$$

Some example of operators are the Bonferroni mean which is a very useful aggregation operator, and can consider the correlations between the aggregated arguments[18-20], the weighted geometric operator [21, 22], the Heronian means for considering the interrelationships between parameters [23, 24] and the power Heronian aggregation operator [25] among others

Project selection is a multicriteria decision problem [26] . This fact makes the process of selecting information systems projects suitable for decision analysis scheme model.

### 2.2 SVN-numbers

Neutrosophy is mathematical theory developed by Florentin Smarandache for dealing with indeterminacy. [27]. It has been the base for developing of new methods to handle indeterminate and inconsistent information like neutrosophic sets an neutrosophic logic and specially in in decision making problems [28, 29] .

The truth value in neutrosophic set is as follows [30]:

Let  $\mathcal{N}$  be a set defined as:  $\mathcal{N} = \{(T, I, F) : T, I, F \subseteq [0, 1]\}$ , a neutrosophic valuation  $n$  is a mapping from the set of propositional formulas to  $\mathcal{N}$ , that is for each sentence  $p$  we have  $v(p) = (T, I, F)$ .

Single valued neutrosophic set (SVNS) [9] was developed with the goal of facilitate real world applications of neutrosophic set and set-theoretic operators. A single-valued neutrosophic set is a special case of neutrosophic set .proposed as a generalization of crisp sets, fuzzy sets, and intuitionistic fuzzy sets in order to deal with incomplete information [10].

A single valued neutrosophic set (SVNS) is defined as follows (Definition 1) [9]:

**Definition 1:** Let  $X$  be a universe of discourse. A single valued neutrosophic set  $A$  over  $X$  is an object having the form of:

$$A = \{(x, (x), (x), (x)): x \in X\} \tag{3}$$

where  $u_A(x): X \rightarrow [0, 1]$ ,  $i_A(x): X \rightarrow [0, 1]$  and  $v_A(x): X \rightarrow [0, 1]$  with  $0 \leq u_A(x) + i_A(x) + v_A(x) \leq 3$  for all

$x \in X$ . The intervals  $u_A(x)$ ,  $v_A(x)$  y  $f_A(x)$  denote the truth- membership degree, the indeterminacy-membership degree and the falsity membership degree of  $x$  to  $A$  respectively.

Single valued neutrosophic numbers (SVN number) are denoted by  $A = (a,b,c)$ , where  $a,b,c \in [0,1]$  and  $a+b+c \leq 3$ .

Alternatives are frequently rated according Euclidean distance in SVN [31-33].

Definition 2: Let  $A^* = (A_1^*, A_2^*, \dots, A_n^*)$  be a vector of  $n$  SVN numbers such that  $A_j^* = (a_j^*, b_j^*, c_j^*)$   $j=(1,2, \dots, n)$  and  $B_i = (B_{i1}, B_{i2}, \dots, B_{in})$  ( $i = 1,2, \dots, m$ ) be  $m$  vectors of  $n$  SVN numbers such that  $B_{ij} = (a_{ij}, b_{ij}, c_{ij})$  ( $i = 1,2, \dots, m$ ), ( $j = 1,2, \dots, n$ ). Then the separation measure between  $B_i$ 's y  $A^*$  is defined as follows:

$$s_i = \left( \frac{1}{3} \sum_{j=1}^n \{ (|a_{ij} - a_j^*|)^2 + (|b_{ij} - b_j^*|)^2 + (|c_{ij} - c_j^*|)^2 \} \right)^{\frac{1}{2}}$$

(4)

( $i = 1,2, \dots, m$ )

Some hybrid vector similarity measures and weighted hybrid vector similarity measures for both single valued and interval neutrosophic sets can be found on [34].

In real world problems, sometimes we can use linguistic terms such as ‘good’, ‘bad’ to describe the state or performance of an alternative and cannot use some numbers to express some qualitative information [35].

The 2-tuple linguistic model could be used[36] for qualitative information but lack indeterminacy. In this paper the concept of linguistic variables [37] is used by mean of single valued neutrosophic numbers [32]for developing a framework to decision support due to the fact that provides adequate computational models to deal with linguistic information [37] in decision allowing to include handling of indeterminate and inconsistent in project selection.

**2.3 AHP Method**

The Analytic Hierarchy Process (AHP) is a technique created by Tom Saaty [38] for making complex decision based. The steps for implementing the AHP model are [39]:

1. Decompose the problem into a hierarchy of goal, criteria, sub-criteria and alternatives.
2. Collect data from experts or decision-makers corresponding to the hierarchic structure, in the pairwise comparison of alternatives on a qualitative scale.
3. Assign a weight to criteria and sub-criteria.
4. Calculate the score for each of the alternatives through pairwise comparison.

One of the great advantages of the analytic hierarchy process is simplicity. Regardless of how many criteria are involved in making the decision, the AHP method only requires comparing a pair of elements. Another important advantage is that it allows the inclusion of tangible variables such as , cost, time as well as intangible ones as criteria such as, comfort, beauty in the decision [40].

Weighting criteria is important in decision making problems in some example weight are given but no method is explained [13] or [14]. In this work the integration of AHP model with project selection allows to assign a weight to each of the criteria involved this more in line with reality and therefore more reliable.

**3 Proposed framework.**

Our aim is to develop a framework for project selection based on SVN numbers and AHP method. The model has been adapted from the common decision scheme that was showed in Fig. 1.

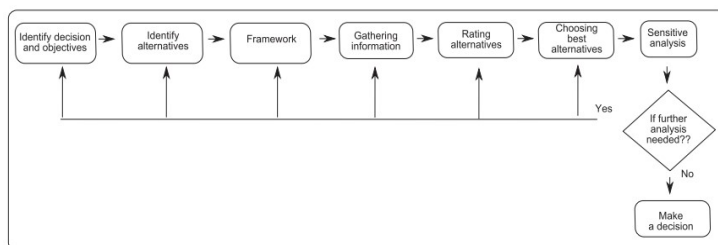

**Figure 1:** Decision resolution scheme.

The model consists of the following phases (fig. 2).

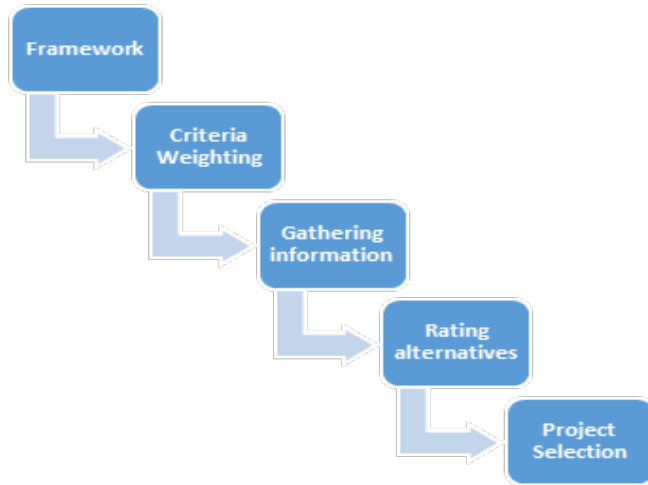

Figure 2: A framework for project selection.

The proposed framework is composed of five activities:

- Framework
- Criteria weighting
- Gathering information,
- Rating alternatives
- Project selection.

Following, the proposed decision method is described in further detail, showing the operation of each phase

**Framework**

In this phase, the evaluation framework, the decision problem of project selection is defined. The framework is established as follows:

- $C = \{c_1, c_2, \dots, c_n\}$  with  $n \geq 2$ , a set of criteria.
- $E = \{e_1, e_2, \dots, e_k\}$  with  $k \geq 1$ , a set of experts.
- $X = \{x_1, x_2, \dots, x_m\}$  with  $m \geq 2$ , a finite set of information technologies projects alternatives.

Criteria and experts might be grouped. The set of experts will provide the assessments of the decision problem.

**Criteria Weighting**

The first step in an AHP analysis is to build a hierarchy, also called decision modeling and it simply consists of building a hierarchy to analyze the decision.

Second step in the AHP process is to derive the relative weights for the criteria. It is called relative because the obtained criteria priorities are measured with respect to each other using Saaty’s pairwise comparison scale (Table I).

TABLE I. TABLE I. SAATY’S PAIRWISE COMPARISON SCALE

Verbal judgment	Numeric value
Extremely im- portant	9
	8
Very Strongly more important	7
	6
Strongly more	5

important	4
Moderately more important	3
Equally important	2
Equally important	1

Based on the responses of the experts, a preference matrix is derived for each respondent for each the criteria involved in the decision with the following format.

TABLE II. PAIRWISE COMPARISON MATRIX OF CRITERIA

Goal	Criteria 1	Criteria 2	...	Criteria n
Criteria 1				
Criteria 2				
...				
Criteria n				

Cells in comparison matrices will have a value from the numeric scale shown in Table I, to reflect relative preference also called intensity judgment or simply judgment in each of the compared pairs [40].

If  $a_{ij}$  is the element of row  $i$  column  $j$  of the matrix, then the lower diagonal is filled using the following formula:

$$a_{ji} = \frac{1}{a_{ij}} \tag{5}$$

Note that that all the element in the comparison matrix are positive,  $a_{ij} > 0$ .

For calculating criteria weights the approximate method is considered simplest. Approximate method for AHP requires the normalization of the comparison matrix adding the values in each column. Next, each cell is divided by the total of the column.

Another approach is proposed in [41]based on row geometrics means of the pairwise comparison matrix:

$$w_i = \frac{\sqrt[n]{\prod_{j=1}^n a_{ij}}}{\sum_{i=1}^n \sqrt[n]{\prod_{j=1}^n a_{ij}}} \tag{6}$$

Saaty [42] proposed the eigenvalue method by calculating the principal eigenvector  $w'$ . This vector corresponds to the largest eigenvalue,  $\lambda_{max}$  of matrix D, as follows:

$$Dw' = \lambda_{max}w' \tag{7}$$

Some discussions have been developed but there is no clear conclusion about the better method for weight determination.

Once judgments have been entered, it is necessary to check that they are consistent. AHP calculates a consistency ratio (CR) comparing the consistency index (CI) of the matrix with our judgments versus the consistency index of a random-like matrix (RI) [43]:

$$CR = \frac{CI}{RI} \tag{8}$$

A consistency ratio (CR) of 0.10 or less is acceptable to continue the AHP analysis. If the consistency ratio is greater than 0.10, it is necessary to revise the judgments to locate the cause of the inconsistency and then correct it [43].

**Gathering information**

In this phase, each expert,  $e_k$  provides the assessments by means of assessment vectors:

$$U^k = (v_{ij}^k, i = 1, \dots, n, j = 1, \dots, m) \tag{9}$$

The assessment  $v_{ij}^k$ , provided by each expert  $e_k$ , for each criterion  $c_i$  of each project alternative  $x_j$ , is expressed using SVN numbers.

Since humans might feel more comfortable using words by means of linguistic labels or terms to articulate their preferences, the ratings of each alternative with respect to each attribute are given as linguistic variables characterized by SVN-numbers in the evaluation process.

Granularity of the linguistic assessments could vary according to the uncertainty and the nature of criteria as well as the background of each expert.

**Rating alternatives**

The aim of this phase is to obtain a global assessment for each alternative. Taking into account the previous phase, an assessment for each alternative is computed, using the selected solving process that allows to manage the information expressed in the decision framework.

Information is aggregated selecting aggregation operators in order to obtain a global assessment for each alternative that summarizes its gathered information.

In this case alternatives are rated according to single valued neutrosophic weighted averaging (SVNWA) aggregation operator was proposed by Ye [44] for SVNSSs as follows[10]:

$$F_w(A_1, A_2, \dots, A_n) = \left( 1 - \prod_{j=1}^n (1 - T_{A_j}(x))^{w_j}, \prod_{j=1}^n (I_{A_j}(x))^{w_j}, \prod_{j=1}^n (F_{A_j}(x))^{w_j} \right) \tag{10}$$

where  $W = (w_1, w_2, \dots, w_n)$  is the waiting vector of  $A_j (j = 1, 2, \dots, n)$ ,  $w_n \in [0, 1]$  and  $\sum_{j=1}^n w_j = 1$ .

or the single valued neutrosophic weighted geometric averaging aggregation operator ( $G_w$ ) [44] :

$$G_w(A_1, A_2, \dots, A_n) = \left( 1 - \prod_{j=1}^n T_{A_j}(x)^{w_j}, \prod_{j=1}^n I_{A_j}(x)^{w_j}, \prod_{j=1}^n F_{A_j}(x)^{w_j} \right) \tag{11}$$

where  $W = (w_1, w_2, \dots, w_n)$  is the waiting vector of  $A_j (j = 1, 2, \dots, n)$ ,  $w_n \in [0, 1]$  and  $\sum_{j=1}^n w_j = 1$ .

Weights (w) in both cases are obtained by the AHP method in phase 2.

**Project Selection**

In this phase of the alternatives are ranked and the most desirable one is chosen by the score function [45, 46].According to the scoring and accuracy functions for SVN-sets, a ranking order of the set of the alternatives can be generated [47]. Selecting option(s) with higher scores.

For ordering alternatives a scoring function is used [48]:

$$s(V_i) = 2 + T_i - F_i - I_i \tag{12}$$

Additionally an accuracy function is defined 31]:

$$\alpha(V_i) = T_i - F_i \tag{13}$$

And then

1. If  $s(V_j) < s(V_i)$ , then  $V_j$  is smaller than  $V_i$ , denoted by  $V_j < V_i$
2. If  $s(V_j) = s(V_i)$ 
  - a. If  $\alpha(V_j) < \alpha(V_i)$ , then  $V_j$  is smaller than  $V_i$ , denoted by  $V_j < V_i$
  - b. If  $\alpha(V_j) = \alpha(V_i)$ , then  $V_j$  and  $V_i$  are the same, denoted by  $V_j = V_i$

Another option is to use the scoring function proposed in [32]:

$$s(V_i) = (1 + T_i - 2F_i - I_i)/2 \tag{14}$$

where  $s(V_i) \in [-1, 1]$ .

If  $s(V_j) < s(V_i)$ , then  $V_j$  is smaller than  $V_i$ , denoted by  $V_j < V_i$

According to the scoring function ranking method of SVN-sets, the ranking order of the set of project alternatives can be generated and the best alternative can be determined.

**4 Illustrative Example**

In this section, we present an illustrative example in order to show the applicability of the proposed framework for information technologies project selection.

An information technology project is a temporary effort undertaken by or on behalf of an organization that [49]:

- Establishes a new technology-based system or service
- Facilitates a significant business process transformation using technology



- Includes a major change in technology architecture or a system migration beyond that considered as general maintenance, enhancement, or refresh activity
- An information technology project typically performs one or more of these functions:
- Develop a new system or service
  - Improvements to a system or service
  - Improve business processes or introduce new ones
  - Build or enhance infrastructure
  - Apply new technologies
  - Upgrade enterprise applications

In this case study the evaluation framework is composed by an expert evaluate 3 alternatives (information technologies development projects).

- $x_1$ : CRM
- $x_2$ : ERP
- $x_3$ : BI

These projects are described in Table #1.

TABLE III. PROJECTS OPTIONS

<b>Id</b>	<b>Name</b>	<b>Description</b>
1	CRM.	Customer Relation Management Software
2	ERP	Enterprise Relationship Management Software
3	BI	Business intelligence System

3 criteria are involved, which are shown below:

- $c_1$ : Benefits
- $c_2$ : Feasibility
- $c_3$ : Cost

In Table 2, we give the set of linguistic terms used for experts to provide the assessments.

TABLE IV. LINGUISTIC TERMS USED TO PROVIDE THE ASSESSMENTS [32]

<b>Linguistic terms</b>	<b>SVNSs</b>
Extremely good (EG)	(1,0,0)
Very very good (VVG)	(0.9, 0.1, 0.1)
Very good (VG)	(0.8,0.15,0.20)
Good (G)	(0.70,0.25,0.30)
Medium good (MG)	(0.60,0.35,0.40)
Medium (M)	(0.50,0.50,0.50)
Medium bad (MB)	(0.40,0.65,0.60)
Bad (B)	(0.30,0.75,0.70)
Very bad (VB)	(0.20,0.85,0.80)
Very very bad (VVB)	(0.10,0.90,0.90)
Extremely bad (EB)	(0,1,1)

Once the evaluation framework has been determined the information about the projects is gathered (see Table 3).

TABLE V. RESULT OF GATHERING INFORMATION

	$x_1$	$x_2$	$x_3$
$c_1$	MG	EG	MB
$c_2$	G	MG	M
$c_3$	MG	MG	G

Using the AHP method the following weights structure (Table IV) was obtained. These are translated into weight vector associated with the criteria  $W = (0.55, 0.26, 0.19)$ .

TABLE VI. CRITERIA WEIGHTS CALCULATION

<b>Weights</b>				
<b>Criteria</b>	$c_1$	$c_2$	$c_3$	<b>Weights</b>

$c_1$	1	3	2	0.55
$c_2$	1/3	1	2	0.26
$c_3$	1/2	1/2	1	0.19

For rating alternatives an initial aggregation process is developed. Then the aggregated SVN decision matrix obtained by aggregating of opinions of decision makers is constructed by Eq. (10). The result is given in Table V.

TABLE VII. DISTANCE TO THE IDEAL SOLUTION

	Aggregation	Scoring function	Ranking
$x_1$	(0.53, 0.4, 0.56)	1.73	2
$x_2$	(0.43, 0.0, 0.0)	2.43	1
$x_3$	(0.66, 0.52, 0.63)	1.62	3

According to the scoring function, three alternatives are ranked as:  $x_2 \succ x_1 \succ x_3$ .

## 5 Conclusions.

Recently, neutrosophic sets and its application to multiple attribute decision making have become a topic of great importance for researchers and practitioners. In this paper a new model project selection based on SVN-number applied allowing the use of linguistic variables. The AHP method is included and allows a correct weighting of different criteria involved.

To demonstrate the applicability of the proposal an illustrative example is presented. Our approach has many application project selection that include indeterminacy and the weighting of criteria. Further works will concentrate extending the model for dealing with heterogeneous information. Another area of future work is the developing of new aggregation models based like the prioritized ordered weighted average operator [50] and the Choquet integral by considering the correlations between the attributes [51].

## References

- Lofti, Z., *Fuzzy sets*. Journal of Information and Control, 1965. **8**(3): p. 338-353.
- Klir, G. and B. Yuan, *Fuzzy sets and fuzzy logic*. Vol. 4. 1995: Prentice hall New Jersey.
- Atanassov, K.T., *Intuitionistic fuzzy sets*. Fuzzy sets and Systems, 1986. **20**(1): p. 87-96.
- Smarandache, F., *Neutrosophy: neutrosophic probability, set, and logic: analytic synthesis & synthetic analysis*. 1998.
- Espinilla, M., et al., *A comparative study of heterogeneous decision analysis approaches applied to sustainable energy evaluation*. International Journal of Uncertainty, Fuzziness and Knowledge-Based Systems, 2012. **20**(supp01): p. 159-174.
- Estrella, F.J., et al., *FLINTSTONES: A fuzzy linguistic decision tools enhancement suite based on the 2-tuple linguistic model and extensions*. Information Sciences, 2014. **280**: p. 152-170.
- Rodríguez, R.M. and L. Martínez, *An analysis of symbolic linguistic computing models in decision making*. International Journal of General Systems, 2013. **42**(1): p. 121-136.
- Zadeh, L.A., *The concept of a linguistic variable and its application to approximate reasoning—I*. Information sciences, 1975. **8**(3): p. 199-249.
- Wang, H., et al., *Single valued neutrosophic sets*. Review of the Air Force Academy, 2010(1): p. 10.
- Biswas, P., S. Pramanik, and B.C. Giri, *TOPSIS method for multi-attribute group decision-making under single-valued neutrosophic environment*. Neural computing and Applications, 2016. **27**(3): p. 727-737.
- Cabezas, R., J.G. Ruiz, and M. Leyva, *A Knowledge-based Recommendation Framework using SVN*. Neutrosophic Sets and Systems, vol. 16/2017: An International Book Series in Information Science and Engineering: p. 24.
- Vaidya, O.S. and S. Kumar, *Analytic hierarchy process: An overview of applications*. European Journal of operational research, 2006. **169**(1): p. 1-29.
- Dalapati, S., et al., *IN-cross Entropy Based MAGDM Strategy under Interval Neutrosophic Set Environment*. Neutrosophic Sets & Systems, 2017. **18**.
- Pramanik, S., et al., *NS-cross entropy-based MAGDM under single-valued neutrosophic set environment*. Information, 2018. **9**(2): p. 37.
- Clemen, R.T., *Making Hard Decisions: An Introduction to Decision Analysis*. 1996: Duxbury Press.
- Calvo, T., et al., *Aggregation operators: properties, classes and construction methods*, in *Aggregation Operators*. 2002, Springer. p. 3-104.
- Torra, V. and Y. Narukawa, *Modeling decisions: information fusion and aggregation operators*. 2007: Springer.
- Liu, P., et al., *Multi-valued neutrosophic number Bonferroni mean operators with their applications in multiple attribute group decision making*. International Journal of Information Technology & Decision Making, 2016. **15**(05): p. 1181-1210.
- Liu, P., J. Liu, and S.-M. Chen, *Some intuitionistic fuzzy Dombi Bonferroni mean operators and their application to multi-attribute group decision making*. Journal of the Operational Research Society, 2018. **69**(1): p. 1-24.

20. Liu, P., S. Chen, and J. Liu, *Some intuitionistic fuzzy interaction partitioned Bonferroni mean operators and their application to multi-attribute group decision making*. Inf. Sci, 2017. **411**: p. 98-121.
21. Liu, P. and P. Wang, *Some q-Rung Orthopair Fuzzy Aggregation Operators and their Applications to Multiple-Attribute Decision Making*. International Journal of Intelligent Systems, 2018. **33**(2): p. 259-280.
22. Biswas, P., S. Pramanik, and B.C. Giri, *Aggregation of triangular fuzzy neutrosophic set information and its application to multi-attribute decision making*. Neutrosophic sets and systems, 2016. **12**(unknown): p. 20-40.
23. Liu, P., J. Liu, and J.M. Merigó, *Partitioned Heronian means based on linguistic intuitionistic fuzzy numbers for dealing with multi-attribute group decision making*. Applied Soft Computing, 2018. **62**: p. 395-422.
24. Liu, P. and S.-M. Chen, *Group decision making based on Heronian aggregation operators of intuitionistic fuzzy numbers*. IEEE transactions on cybernetics, 2017. **47**(9): p. 2514-2530.
25. Liu, P., *Multiple attribute group decision making method based on interval-valued intuitionistic fuzzy power Heronian aggregation operators*. Computers & Industrial Engineering, 2017. **108**: p. 199-212.
26. Lee, J.W. and S.H. Kim, *An integrated approach for interdependent information system project selection*. International Journal of Project Management, 2001. **19**(2): p. 111-118.
27. Smarandache, F., *A Unifying Field in Logics: Neutrosophic Logic*. Philosophy, 1999: p. 1-141.
28. Smarandache, F., *A Unifying Field in Logics: Neutrosophic Logic. Neutrosophy, Neutrosophic Set, Neutrosophic Probability: Neutrosophic Logic. Neutrosophy, Neutrosophic Set, Neutrosophic Probability*. 2005: Infinite Study.
29. Vera, M., et al., *Las habilidades del marketing como determinantes que sustentaran la competitividad de la Industria del arroz en el cantón Yaguachi. Aplicación de los números SVN a la priorización de estrategias*. Neutrosophic Sets & Systems, 2016. **13**.
30. Riviuccio, U., *Neutrosophic logics: Prospects and problems*. Fuzzy sets and systems, 2008. **159**(14): p. 1860-1868.
31. Ye, J., *Single-valued neutrosophic minimum spanning tree and its clustering method*. Journal of intelligent Systems, 2014. **23**(3): p. 311-324.
32. Şahin, R. and M. Yiğider, *A Multi-criteria neutrosophic group decision making method based TOPSIS for supplier selection*. arXiv preprint arXiv:1412.5077, 2014.
33. Henriquez Antepara, E.J., et al., *Competencies evaluation based on single valued neutrosophic numbers and decision analysis schema*. Neutrosophic Sets & Systems, 2017.
34. Pramanik, S., P. Biswas, and B.C. Giri, *Hybrid vector similarity measures and their applications to multi-attribute decision making under neutrosophic environment*. Neural computing and Applications, 2017. **28**(5): p. 1163-1176.
35. Liu, P. and L. Shi, *Some neutrosophic uncertain linguistic number Heronian mean operators and their application to multi-attribute group decision making*. Neural Computing and Applications, 2017. **28**(5): p. 1079-1093.
36. Liu, P. and S.-M. Chen, *Multiattribute group decision making based on intuitionistic 2-tuple linguistic information*. Information Sciences, 2018. **430**: p. 599-619.
37. Leyva-Vázquez, M., et al. *The Extended Hierarchical Linguistic Model in Fuzzy Cognitive Maps*. in *Technologies and Innovation: Second International Conference, CITI 2016, Guayaquil, Ecuador, November 23-25, 2016, Proceedings 2*. 2016. Springer.
38. Saaty, T.L., *What is the analytic hierarchy process?*, in *Mathematical models for decision support*. 1988, Springer. p. 109-121.
39. Al-Harbi, K.M.A.-S., *Application of the AHP in project management*. International journal of project management, 2001. **19**(1): p. 19-27.
40. Mu, E. and M. Pereyra-Rojas, *Understanding the Analytic Hierarchy Process*, in *Practical Decision Making using Super Decisions v3*. 2018, Springer. p. 7-22.
41. Crawford, G. and C. Williams, *A note on the analysis of subjective judgment matrices*. Journal of mathematical psychology, 1985. **29**(4): p. 387-405.
42. Saaty, T.L., *The analytical hierarchical process*. J Wiley, New York, 1980.
43. Saaty, T.L., *Decision making for leaders: the analytic hierarchy process for decisions in a complex world*. 1990: RWS publications.
44. Ye, J., *A multicriteria decision-making method using aggregation operators for simplified neutrosophic sets*. Journal of Intelligent & Fuzzy Systems, 2014. **26**(5): p. 2459-2466.
45. Liu, P. and H. Li, *Multiple attribute decision-making method based on some normal neutrosophic Bonferroni mean operators*. Neural Computing and Applications, 2017. **28**(1): p. 179-194.
46. Biswas, P., S. Pramanik, and B.C. Giri, *Value and ambiguity index based ranking method of single-valued trapezoidal neutrosophic numbers and its application to multi-attribute decision making*. Neutrosophic Sets and Systems, 2016. **12**(unknown): p. 127-137.
47. Liu, P. and F. Teng, *Multiple attribute decision making method based on normal neutrosophic generalized weighted power averaging operator*. International Journal of Machine Learning and Cybernetics, 2018. **9**(2): p. 281-293.
48. Deli, I., *Linear weighted averaging method on SVN-sets and its sensitivity analysis based on multi-attribute decision making problems*. 2015.
49. Sandoval-Almazán, R., et al., *Managing Information Technology Development Projects*, in *Building Digital Government Strategies*. 2017, Springer. p. 65-77.
50. Liu, P. and Y. Wang, *Interval neutrosophic prioritized OWA operator and its application to multiple attribute decision making*. Journal of Systems Science and Complexity, 2016. **29**(3): p. 681-697.
51. Liu, P. and G. Tang, *Multi-criteria group decision-making based on interval neutrosophic uncertain linguistic variables and Choquet integral*. Cognitive Computation, 2016. **8**(6): p. 1036-1056.

Received: August 1, 2018. Accepted: August 24, 2018.



# A Revisit to NC-VIKOR Based MAGDM Strategy in Neutrosophic Cubic Set Environment

Shyamal Dalapati<sup>1</sup>, Surapati Pramanik<sup>2</sup>,

<sup>1</sup> Department of Mathematics, Indian Institute of Engineering Science and Technology, Shibpur, P.O.-Botanic Garden, Howrah-711103, West Bengal, India. E-mail: dalapatishyamal30@gmail.com

<sup>2</sup> Department of Mathematics, Nandalal Ghosh B.T. College, Panpur, P.O.-Narayanpur, District –North 24 Parganas, Pin code-743126, West Bengal, India. E-mail: sura\_pati@yahoo.co.in

**Abstract.** Multi attribute group decision making with VIKOR (VlseKriterijuska Optimizacija I Komoromisno Resenje) strategy has been widely applied to solving real-world problems. Recently, Pramanik et al. [S. Pramanik, S. Dalapati, S. Alam, and T. K. Roy. NC-VIKOR based MAGDM strategy under neutrosophic cubic set environment, *Neutrosophic Sets and Systems*, 20 (2018), 95-108] proposed VIKOR strategy for solving MAGDM, where compromise solutions are not identified in neutrosophic cubic environment. To overcome the shortcomings of the paper, we further modify the VIKOR strategy by incorporating compromise solution in neutrosophic cubic set environment. Finally, we solve an MAGDM problem using the modified NC-VIKOR strategy to show the feasibility, applicability and effectiveness of the proposed strategy. Further, we present sensitivity analysis to show the impact of different values of the decision making mechanism coefficient on ranking order of the alternatives.

**Keywords:** MAGDM, NCS, NC-VIKOR strategy.

## 1. Introduction

Neutrosophic set [1] is derived from Neutrosophy [1], a new branch of philosophy. It is characterized by the three independent functions, namely, truth membership function, indeterminacy function and falsity membership function as independent components. Each of three independent components of NS belongs to  $[0, 1]^+$ . Wang et al. [4] introduced single valued neutrosophic set (SVNS) where each of truth, indeterminacy and falsity membership function belongs to  $[0, 1]$ . Applications of NSs and SVNSs are found in various areas of research such as conflict resolution [5], clustering analysis [6-9], decision making [10-39], educational problem [40, 41], image processing [42-45], medical diagnosis [46, 47], social problem [48, 49], etc. Wang et al. [50] proposed interval neutrosophic set (INS). Mondal et al. [51] defined tangent function of interval neutrosophic set and develop a strategy for multi attribute decision making (MADM) problems. Dalapati et al. [52] defined a new cross entropy measure for interval neutrosophic set and developed a multi attribute group decision making (MAGDM) strategy.

By combining SVNS and INS, Ali et al. [53] proposed neutrosophic cubic set (NCS). Zhan et al. [54] presented two weighted average operators on NCSs and employed the operators for MADM problems. Banerjee et al. [55] introduced the grey relational analysis based MADM strategy in NCS environment. Lu and Ye [56] proposed three cosine measures between NCSs and presented MADM strategy in NCS environment. Pramanik et al. [57] defined similarity measure for NCSs and proved its basic properties. In the same study, Pramanik et al. [57] presented a new MAGDM strategy with linguistic variables in NCS environment. Pramanik et al. [58] proposed the score and accuracy functions for NCSs and prove their basic properties. In the same study, Pramanik et al. [58] developed a strategy for ranking of neutrosophic cubic numbers (NCNs) based on the score and accuracy functions. In the same study, Pramanik et al. [58] first developed a TODIM (Tomada de decisao interativa e multicritério), called the NC-TODIM and presented new NC-TODIM [58] strategy for solving MAGDM in NCS environment. Shi and Ye [59] introduced Dombi aggregation operators of NCSs and applied them for MADM problem. Pramanik et al. [60] proposed an extended technique for order preference by similarity to ideal solution (TOPSIS) strategy in NCS environment for solving MADM problem. Ye [61] present operations and aggregation method of neutrosophic cubic numbers for MADM. Pramanik et al. [62] presented some operations and properties of neutrosophic cubic soft set.

Opricovic [63] proposed the VIKOR strategy for a multi criteria decision making (MCDM) problem with conflicting criteria [64-65]. In 2015, Bausys and Zavadskas [66] extended the VIKOR strategy to INS environment and applied it to solve MCDM problem. Further, Hung et al. [67] proposed VIKOR strategy for interval neutrosophic MAGDM. Poursmaeil et al. [68] proposed an MAGDM strategy based on TOPSIS and VIKOR in SVNS environment. Liu and Zhang [69] extended VIKOR strategy in neutrosophic hesitant fuzzy set environment. Hu et al. [70] proposed interval neutrosophic projection based VIKOR strategy and employed it for doctor selection. Selvakumari et al. [71] proposed VIKOR strategy for decision making problem using octagonal neutrosophic soft matrix. Pramanik et al. [72] proposed VIKOR based MAGDM strategy under bipolar neutrosophic set environment.

The remainder of the paper is organized as follows: In the section 2, we review some basic concepts and operations related to NS, SVNS, NCS. In Section 3, we present a modified NC-VIKOR strategy to solve the MAGDM problems in NCS environment. In Section 4, we solve an illustrative example using the modified NC-VIKOR in NCS environment. Then, in Section 5, we present the sensitivity analysis. In Section 6, we present conclusion and future scope research.

## 2. Preliminaries

### Definition 1. Single valued neutrosophic set

Let  $X$  be a space of points (objects) with a generic element in  $X$  denoted by  $x$ . A single valued neutrosophic set [4]  $B$  in  $X$  is expressed as:

$$B = \{ \langle x : (T_B(x), I_B(x), F_B(x)) \rangle : x \in X \}, \text{ where } T_B(x), I_B(x), F_B(x) \in [0, 1].$$

For each  $x \in X$ ,  $T_B(x), I_B(x), F_B(x) \in [0, 1]$  and  $0 \leq T_B(x) + I_B(x) + F_B(x) \leq 3$ .

### Definition 2. Interval neutrosophic set

An interval neutrosophic set [50]  $\tilde{A}(x)$  of a nonempty set  $X$  is expressed by truth-membership function  $T_{\tilde{A}}(x)$ , the indeterminacy membership function  $I_{\tilde{A}}(x)$  and falsity membership function  $F_{\tilde{A}}(x)$ . For each  $x \in X$ ,  $T_{\tilde{A}}(x)$ ,  $I_{\tilde{A}}(x)$ ,  $F_{\tilde{A}}(x) \subseteq [0, 1]$  and  $\tilde{A}$  defined as follows:

$$\tilde{A}(x) = \{ \langle x, [T_{\tilde{A}}^-(x), T_{\tilde{A}}^+(x)], [I_{\tilde{A}}^-(x), I_{\tilde{A}}^+(x)], [F_{\tilde{A}}^-(x), F_{\tilde{A}}^+(x)] \mid \forall x \in X \}. \text{ Here, } T_{\tilde{A}}^-(x), T_{\tilde{A}}^+(x), I_{\tilde{A}}^-(x), I_{\tilde{A}}^+(x), F_{\tilde{A}}^-(x), F_{\tilde{A}}^+(x) : X \rightarrow ]^{-}0, 1^{+}[ \text{ and } ^{-}0 \leq \sup T_{\tilde{A}}^+(x) + \sup I_{\tilde{A}}^+(x) + \sup F_{\tilde{A}}^+(x) \leq 3^{+}.$$

Here, we consider  $T_{\tilde{A}}^-(x), T_{\tilde{A}}^+(x), I_{\tilde{A}}^-(x), I_{\tilde{A}}^+(x), F_{\tilde{A}}^-(x), F_{\tilde{A}}^+(x) : X \rightarrow [0, 1]$  for real applications.

### Definition 3. Neutrosophic cubic set

A neutrosophic cubic set [53] in a non-empty set  $X$  is defined as  $N = \{ \langle x, \tilde{A}(x), A(x) \rangle : \forall x \in X \}$ , where  $\tilde{A}$  and  $A$  are the interval neutrosophic set and neutrosophic set in  $X$  respectively. For convenience, we can simply use  $N = \langle \tilde{A}, A \rangle$  to represent an element  $N$  in neutrosophic cubic set and the element  $N$  can be called a neutrosophic cubic number (NCN).

#### Some operations of neutrosophic cubic sets: [53]

##### i. Union of any two neutrosophic cubic sets

Let  $N_1 = \langle \tilde{A}_1(x), A_1(x) \rangle$  and  $N_2 = \langle \tilde{A}_2(x), A_2(x) \rangle$  be any two neutrosophic cubic sets in a non-empty set  $H$ . Then the union of  $N_1$  and  $N_2$  denoted by  $N_1 \cup N_2$  is defined as follows:

$$N_1 \cup N_2 = \left\langle \tilde{A}_1(x) \cup \tilde{A}_2(x), A_1(x) \cup A_2(x), \forall x \in X \right\rangle, \text{ where,}$$

$$\tilde{A}_1(x) \cup \tilde{A}_2(x) = \{ \langle x, [\max\{T_{\tilde{A}_1}^-(x), T_{\tilde{A}_2}^-(x)\}, \max\{T_{\tilde{A}_1}^+(x), T_{\tilde{A}_2}^+(x)\}], [\min\{I_{\tilde{A}_1}^-(x), I_{\tilde{A}_2}^-(x)\}, \min\{I_{\tilde{A}_1}^+(x), I_{\tilde{A}_2}^+(x)\}], [\min\{F_{\tilde{A}_1}^-(x), F_{\tilde{A}_2}^-(x)\}, \min\{F_{\tilde{A}_1}^+(x), F_{\tilde{A}_2}^+(x)\}] \rangle: x \in X\} \text{ and } A_1(x) \cup A_2(x) = \{ \langle x, \max\{T_{A_1}(x), T_{A_2}(x)\}, \min\{I_{A_1}(x), I_{A_2}(x)\}, \min\{F_{A_1}(x), F_{A_2}(x)\} \rangle: \forall x \in X\}.$$

**ii. Intersection of any two neutrosophic cubic sets**

Intersection of  $N_1$  and  $N_2$  denoted by  $N_1 \cap N_2$  is defined as follows:

$$N_1 \cap N_2 = \left\langle \tilde{A}_1(x) \cap \tilde{A}_2(x), A_1(x) \cap A_2(x) \forall x \in X \right\rangle, \text{ where } \tilde{A}_1(x) \cap \tilde{A}_2(x) = \{ \langle x, [\min\{T_{\tilde{A}_1}^-(x), T_{\tilde{A}_2}^-(x)\}, \min\{T_{\tilde{A}_1}^+(x), T_{\tilde{A}_2}^+(x)\}], [\max\{I_{\tilde{A}_1}^-(x), I_{\tilde{A}_2}^-(x)\}, \max\{I_{\tilde{A}_1}^+(x), I_{\tilde{A}_2}^+(x)\}], [\max\{F_{\tilde{A}_1}^-(x), F_{\tilde{A}_2}^-(x)\}, \max\{F_{\tilde{A}_1}^+(x), F_{\tilde{A}_2}^+(x)\}] \rangle: x \in X\} \text{ and } A_1(x) \cap A_2(x) = \{ \langle x, \min\{T_{A_1}(x), T_{A_2}(x)\}, \max\{I_{A_1}(x), I_{A_2}(x)\}, \max\{F_{A_1}(x), F_{A_2}(x)\} \rangle: \forall x \in X\}.$$

**iii. Complement of a neutrosophic cubic set**

Let  $N_1 = \langle \tilde{A}_1(x), A_1(x) \rangle$  be an NCS in  $X$ . Then compliment of  $N_1 = \langle \tilde{A}_1(x), A_1(x) \rangle$  is denoted by  $N_1^c = \{ \langle x, \tilde{A}_1^c(x), A_1^c(x) \rangle: \forall x \in X\}$ .

$$\text{Here, } \tilde{A}_1^c = \{ \langle x, [T_{\tilde{A}_1^c}^+(x), T_{\tilde{A}_1^c}^-(x)], [I_{\tilde{A}_1^c}^+(x), I_{\tilde{A}_1^c}^-(x)], [F_{\tilde{A}_1^c}^+(x), F_{\tilde{A}_1^c}^-(x)] \rangle: \forall x \in X\},$$

$$\text{where, } T_{\tilde{A}_1^c}^-(x) = \{1\} - T_{\tilde{A}_1}^-(x), T_{\tilde{A}_1^c}^+(x) = \{1\} - T_{\tilde{A}_1}^+(x), I_{\tilde{A}_1^c}^-(x) = \{1\} - I_{\tilde{A}_1}^-(x), I_{\tilde{A}_1^c}^+(x) = \{1\} - I_{\tilde{A}_1}^+(x),$$

$$F_{\tilde{A}_1^c}^-(x) = \{1\} - F_{\tilde{A}_1}^-(x), F_{\tilde{A}_1^c}^+(x) = \{1\} - F_{\tilde{A}_1}^+(x), \text{ and } T_{A_1^c}(x) = \{1\} - T_{A_1}(x), I_{A_1^c}(x) = \{1\} - I_{A_1}(x),$$

$$F_{A_1^c}(x) = \{1\} - F_{A_1}(x).$$

**iv. Containment**

$$\text{Let } N_1 = \langle \tilde{A}_1, A_1 \rangle = \{ \langle x, [T_{\tilde{A}_1}^-(x), T_{\tilde{A}_1}^+(x)], [I_{\tilde{A}_1}^-(x), I_{\tilde{A}_1}^+(x)], (T_{A_1}(x), I_{A_1}(x), F_{A_1}(x)) \rangle: x \in X\} \text{ and}$$

$$N_2 = \langle \tilde{A}_2, A_2 \rangle = \{ \langle x, [T_{\tilde{A}_2}^-(x), T_{\tilde{A}_2}^+(x)], [I_{\tilde{A}_2}^-(x), I_{\tilde{A}_2}^+(x)], (T_{A_2}(x), I_{A_2}(x), F_{A_2}(x)) \rangle: x \in X\} \text{ be}$$

any two neutrosophic cubic sets in a non-empty set  $X$ ,

$$\text{then, (i) } N_1 \subseteq N_2 \text{ if and only if } T_{\tilde{A}_1}^-(x) \leq T_{\tilde{A}_2}^-(x), T_{\tilde{A}_1}^+(x) \leq T_{\tilde{A}_2}^+(x), I_{\tilde{A}_1}^-(x) \geq I_{\tilde{A}_2}^-(x), I_{\tilde{A}_1}^+(x) \geq I_{\tilde{A}_2}^+(x),$$

$$F_{\tilde{A}_1}^-(x) \geq F_{\tilde{A}_2}^-(x), F_{\tilde{A}_1}^+(x) \geq F_{\tilde{A}_2}^+(x), \text{ and } T_{A_1}(x) \leq T_{A_2}(x), I_{A_1}(x) \geq I_{A_2}(x), F_{A_1}(x) \geq F_{A_2}(x) \text{ for all } x \in X.$$

**Definition 4. Distance between two NCNs**

Let  $N_1 = \langle [a_1, a_2], [b_1, b_2], [c_1, c_2], (a, b, c) \rangle$  and  $N_2 = \langle [d_1, d_2], [e_1, e_2], [f_1, f_2], (d, e, f) \rangle$  be any two NC-numbers, then distance [58] between them is defined by

$$H(N_1, N_2) = \frac{1}{9} [|a_1 - d_1| + |a_2 - d_2| + |b_1 - e_1| + |b_2 - e_2| + |c_1 - f_1| + |c_2 - f_2| + |a - d| + |b - e| + |c - f|] \tag{1}$$

**Definition 5. Procedure of normalization**

In general, benefit type attributes and cost type attributes can exist simultaneously in MAGDM problem. Therefore the decision matrix must be normalized. Let  $a_{ij}$  be an NC-number to express the rating value of  $i$ -th alternative with respect to  $j$ -th attribute ( $\Psi_j$ ). When attribute  $\Psi_j \in C$  or  $\Psi_j \in G$  (where  $C$  and  $G$  be the set of

cost type attributes and set of benefit type attributes respectively), the normalized values for cost type attribute and benefit type attribute are calculated by using the following expression (2).

$$a_{ij}^* = \begin{cases} a_{ij} & \text{if } \Psi_j \in G \\ 1 - a_{ij} & \text{if } \Psi_j \in C \end{cases} \quad (2)$$

where  $a_{ij}$  is the performance rating of  $i$ th alternative for attribute  $\Psi_j$ .

### 3. VIKOR strategy for solving MAGDM problem in NCS environment

In this section, we propose modified NC-VIKOR strategy from an MAGDM strategy in NCS environment. Assume that  $\Phi = \{\Phi_1, \Phi_2, \Phi_3, \dots, \Phi_r\}$  be a set of  $r$  alternatives and  $\Psi = \{\Psi_1, \Psi_2, \Psi_3, \dots, \Psi_s\}$  be a set of  $s$  attributes. Assume that  $W = \{w_1, w_2, w_3, \dots, w_s\}$  be the weight vector of the attributes, where  $w_k \geq 0$  and  $\sum_{k=1}^s w_k = 1$ . Assume that  $E = \{E_1, E_2, E_3, \dots, E_M\}$  be the set of  $M$  decision makers and

$\zeta = \{\zeta_1, \zeta_2, \zeta_3, \dots, \zeta_M\}$  be the set of weight vector of decision makers, where  $\zeta_p \geq 0$  and  $\sum_{p=1}^M \zeta_p = 1$ .

The proposed MAGDM strategy consists of the following steps:

#### Step: 1. Construction of the decision matrix

Let  $DM^p = (a_{ij}^p)_{r \times s}$  ( $p = 1, 2, 3, \dots, t$ ) be the  $p$ -th decision matrix, where information about the alternative  $\Phi_i$  provided by the decision maker or expert  $E_p$  with respect to attribute  $\Psi_j$  ( $j = 1, 2, 3, \dots, s$ ). The  $p$ -th decision matrix denoted by  $DM^p$  (See Equation (3)) is constructed as follows:

$$DM^p = \begin{pmatrix} & \Psi_1 & \Psi_2 & \dots & \Psi_s \\ \Phi_1 & a_{11}^p & a_{12}^p & \dots & a_{1s}^p \\ \Phi_2 & a_{21}^p & a_{22}^p & & a_{2s}^p \\ \cdot & \cdot & \cdot & \cdot & \cdot \\ \Phi_r & a_{r1}^p & a_{r2}^p & \dots & a_{rs}^p \end{pmatrix} \quad (3)$$

Here  $p = 1, 2, 3, \dots, M$ ;  $i = 1, 2, 3, \dots, r$ ;  $j = 1, 2, 3, \dots, s$ .

#### Step: 2. Normalization of the decision matrix

We use Equation (2) for normalizing the cost type attributes and benefit type attributes. After normalization, the normalized decision matrix (Equation (3)) is represented as follows (see Equation 4):

$$DM^p = \begin{pmatrix} & \Psi_1 & \Psi_2 & \dots & \Psi_s \\ \Phi_1 & a_{11}^{*p} & a_{12}^{*p} & \dots & a_{1s}^{*p} \\ \Phi_2 & a_{21}^{*p} & a_{22}^{*p} & & a_{2s}^{*p} \\ \cdot & \cdot & \cdot & \cdot & \cdot \\ \Phi_r & a_{r1}^{*p} & a_{r2}^{*p} & \dots & a_{rs}^{*p} \end{pmatrix} \quad (4)$$

Here,  $p = 1, 2, 3, \dots, M$ ;  $i = 1, 2, 3, \dots, r$ ;  $j = 1, 2, 3, \dots, s$ .

#### Step: 3. Aggregated decision matrix

For group decision, we aggregate all the individual decision matrices ( $DM^p$ ,  $p = 1, 2, \dots, M$ ) to an aggregated decision matrix (DM) using the neutrosophic cubic numbers weighted aggregation (NCNWA) [73] operator as follows:

$$\begin{aligned}
 a_{ij} = \text{NCNWA}_{\zeta}(a_{ij}^1, a_{ij}^2, \dots, a_{ij}^M) &= (\zeta_1 a_{ij}^1 \oplus \zeta_2 a_{ij}^2 \oplus \zeta_3 a_{ij}^3 \oplus \dots \oplus \zeta_M a_{ij}^M) = \\
 &< \left( \left[ \sum_{p=1}^M \zeta_p T_{ij}^{-(p)}, \sum_{p=1}^M \zeta_p T_{ij}^{+(p)} \right], \left[ \sum_{p=1}^M \zeta_p I_{ij}^{-(p)}, \sum_{p=1}^M \zeta_p I_{ij}^{+(p)} \right], \right. \\
 &\left. \left[ \sum_{p=1}^M \zeta_p F_{ij}^{-(p)}, \sum_{p=1}^M \zeta_p F_{ij}^{+(p)} \right], \left( \sum_{p=1}^M \zeta_p T_{ij}^{(p)}, \sum_{p=1}^M \zeta_p I_{ij}^{(p)}, \sum_{p=1}^M \zeta_p F_{ij}^{(p)} \right) \right] > \tag{5}
 \end{aligned}$$

Therefore, the aggregated decision matrix is defined as follows:

$$\text{DM} = \begin{pmatrix} \Psi_1 & \Psi_2 & \dots & \Psi_s \\ \Phi_1 & a_{11} & a_{12} \dots & a_{1s} \\ \Phi_2 & a_{21} & a_{22} & a_{2s} \\ \dots & \dots & \dots & \dots \\ \Phi_r & a_{r1} & a_{r2} \dots & a_{rs} \end{pmatrix} \tag{6}$$

Here,  $i = 1, 2, 3, \dots, r; j = 1, 2, 3, \dots, s; p = 1, 2, \dots, M$ .

**Step: 4. Define the positive ideal solution and negative ideal solution**

$$a_{ij}^+ = \langle [\max_i t_{ij}^-, \max_i t_{ij}^+], [\min_i i_{ij}^-, \min_i i_{ij}^+], [\min_i f_{ij}^-, \min_i f_{ij}^+], (\max_i t_{ij}, \min_i f_{ij}, \min_i f_{ij}) \rangle \tag{7}$$

$$a_{ij}^- = \langle [\min_i t_{ij}^-, \min_i t_{ij}^+], [\max_i i_{ij}^-, \max_i i_{ij}^+], [\max_i f_{ij}^-, \max_i f_{ij}^+], (\min_i t_{ij}, \max_i f_{ij}, \max_i f_{ij}) \rangle \tag{8}$$

**Step: 5. Compute  $\Gamma_i$  and  $Z_i$**

$\Gamma_i$  and  $Z_i$  represent the average and worst group scores for the alternative  $A_i$  respectively with the relations

$$\Gamma_i = \sum_{j=1}^s \frac{w_j \times D(a_{ij}^+, a_{ij}^*)}{D(a_{ij}^+, a_{ij}^-)} \tag{9}$$

$$Z_i = \max_j \left\{ \frac{w_j \times D(a_{ij}^+, a_{ij}^*)}{D(a_{ij}^+, a_{ij}^-)} \right\} \tag{10}$$

Here,  $w_j$  is the weight of  $\Psi_j$ .

The smaller values of  $\Gamma_i$  and  $Z_i$  correspond to the better average and worse group scores for alternative  $A_i$ , respectively.

**Step: 6. Calculate the values of  $\phi_i$  ( $i = 1, 2, 3, \dots, r$ )**

$$\phi_i = \gamma \frac{(\Gamma_i - \Gamma^-)}{(\Gamma^+ - \Gamma^-)} + (1 - \gamma) \frac{(Z_i - Z^-)}{(Z^+ - Z^-)} \tag{11}$$

$$\text{Here, } \Gamma_i^- = \min_i \Gamma_i, \Gamma_i^+ = \max_i \Gamma_i, Z_i^- = \min_i Z_i, Z_i^+ = \max_i Z_i \tag{12}$$

and  $\gamma$  depicts the decision making mechanism coefficient. If  $\gamma > 0.5$ , it is for “the maximum group utility”; If  $\gamma < 0.5$ , it is “the minimum regret”, and it is both if  $\gamma = 0.5$ .

**Step: 7. Rank the priority of alternatives**

Rank the alternatives by  $\phi_i, \Gamma_i$  and  $Z_i$  according to the rule of traditional VIKOR strategy. The smaller value reflects the better alternative.



### Step: 8. Determine the compromise solution

Obtain alternative  $\Phi^1$  as a compromise solution, which is ranked as the best by the measure  $\varphi$  (Minimum) if the following two conditions are satisfied:

**Condition 1.** Acceptable stability:  $\varphi(\Phi^2) - \varphi(\Phi^1) \geq \frac{1}{(r-1)}$ , where  $\Phi^1, \Phi^2$  are the alternatives with first and second position in the ranking list by  $\varphi$ ;  $r$  is the number of alternatives.

**Condition 2.** Acceptable stability in decision making: Alternative  $\Phi^1$  must also be the best ranked by  $\Gamma$  or/and  $Z$ . This compromise solution is stable within whole decision making process.

If one of the conditions is not satisfied, then a set of compromise solutions is proposed as follows:

- ◇ Alternatives  $\Phi^1$  and  $\Phi^2$  are compromise solutions if only condition 2 is not satisfied, or
- ◇  $\Phi^1, \Phi^2, \Phi^3, \dots, \Phi^r$  are compromise solutions if condition 1 is not satisfied and  $\Phi^r$  is decided by constraint  $\varphi(\Phi^r) - \varphi(\Phi^1) \leq \frac{1}{(r-1)}$  for maximum  $r$ .

### 4. Illustrative example

To demonstrate the feasibility, applicability and effectiveness of the proposed strategy, we solve an MAGDM problem adapted from [74]. We assume that an investment company wants to invest a sum of money in the best option. The investment company forms a decision making board comprising of three members ( $E_1, E_2, E_3$ ) who evaluate the four alternatives to invest money. The alternatives are Car company ( $\Phi_1$ ), Food company ( $\Phi_2$ ), Computer company ( $\Phi_3$ ) and Arms company ( $\Phi_4$ ). Decision makers take decision to evaluate alternatives based on the attributes namely, risk factor ( $\Psi_1$ ), growth factor ( $\Psi_2$ ), environment impact ( $\Psi_3$ ). We consider three criteria as benefit type based on Pramanik et al. [58]. Assume that the weight vector of attributes is  $W = (0.36, 0.37, 0.27)^T$  and weight vector of decision makers or experts is  $\zeta = (0.26, 0.40, 0.34)^T$ . Now, we apply the modified NC-VIKOR strategy using the following steps.

#### Step: 1. Construction of the decision matrix

We construct the decision matrices as follows:

$$\begin{array}{c} \text{Decision matrix for DM}^1 \text{ in NCN form} \\ \left( \begin{array}{ccc} \Psi_1 & \Psi_2 & \Psi_3 \\ \Phi_1 < [7, 9], [1, 2], [1, 2], (9, 2, 2) > < [7, 9], [1, 2], [1, 2], (9, 2, 2) > < [4, 5], [4, 5], [4, 5], (5, 5, 5) > \\ \Phi_2 < [6, 8], [2, 3], [2, 4], (8, 3, 4) > < [4, 5], [4, 5], [4, 5], (5, 5, 5) > < [7, 9], [1, 2], [1, 2], (9, 2, 2) > \\ \Phi_3 < [4, 5], [4, 5], [4, 5], (5, 5, 5) > < [6, 8], [2, 3], [2, 4], (8, 3, 4) > < [4, 5], [4, 5], [4, 5], (5, 5, 5) > \\ \Phi_4 < [3, 4], [5, 6], [5, 7], (4, 6, 7) > < [4, 5], [4, 5], [4, 5], (5, 5, 5) > < [7, 9], [1, 2], [1, 2], (9, 2, 2) > \end{array} \right) \end{array} \quad (13)$$

$$\begin{array}{c} \text{Decision matrix for DM}^2 \text{ in NCN form} \\ \left( \begin{array}{ccc} \Psi_1 & \Psi_2 & \Psi_3 \\ \Phi_1 < [3, 4], [5, 6], [5, 7], (4, 6, 7) > < [4, 5], [4, 5], [4, 5], (5, 5, 5) > < [7, 9], [1, 2], [1, 2], (9, 2, 2) > \\ \Phi_2 < [4, 5], [4, 5], [4, 5], (5, 5, 5) > < [4, 5], [4, 5], [4, 5], (5, 5, 5) > < [7, 9], [1, 2], [1, 2], (9, 2, 2) > \\ \Phi_3 < [7, 9], [1, 2], [1, 2], (9, 2, 2) > < [7, 9], [1, 2], [1, 2], (9, 2, 2) > < [4, 5], [4, 5], [4, 5], (5, 5, 5) > \\ \Phi_4 < [6, 8], [2, 3], [2, 4], (8, 3, 4) > < [4, 5], [4, 5], [4, 5], (5, 5, 5) > < [7, 9], [1, 2], [1, 2], (9, 2, 2) > \end{array} \right) \end{array} \quad (14)$$

$$\begin{array}{c} \text{Decision matrix for DM}^3 \text{ in NC-number form} \\ \left( \begin{array}{ccc} \Psi_1 & \Psi_2 & \Psi_3 \\ \Phi_1 < [4, 5], [4, 5], [4, 5], (5, 5, 5) > < [4, 5], [4, 5], [4, 5], (5, 5, 5) > < [7, 9], [1, 2], [1, 2], (9, 2, 2) > \\ \Phi_2 < [4, 5], [4, 5], [4, 5], (5, 5, 5) > < [7, 9], [1, 2], [1, 2], (9, 2, 2) > < [4, 5], [4, 5], [4, 5], (5, 5, 5) > \\ \Phi_3 < [7, 9], [1, 2], [1, 2], (9, 2, 2) > < [6, 8], [2, 3], [2, 4], (8, 3, 4) > < [6, 8], [2, 3], [2, 4], (8, 3, 4) > \\ \Phi_4 < [7, 9], [1, 2], [1, 2], (9, 2, 2) > < [4, 5], [4, 5], [4, 5], (5, 5, 5) > < [3, 4], [5, 6], [5, 7], (4, 6, 7) > \end{array} \right) \end{array} \quad (15)$$

#### Step: 2. Normalization of the decision matrix

Since all the criteria are considered as benefit type, we do not need to normalize the decision matrices ( $DM^1, DM^2, DM^3$ ).

**Step: 3. Aggregated decision matrix**

Using equation eq. (5), the aggregated decision matrix of (13, 14, 15) is presented below:

$$\left( \begin{array}{ccc} & \Psi_1 & \Psi_2 & \Psi_3 \\ \Phi_1 & \langle [0.44, .56], [0.36, .46], [0.36, .51], (.56, .46, .50) \rangle & \langle [0.48, .60], [0.32, .42], [0.32, .42], (.60, .42, .42) \rangle & \langle [0.62, .80], [0.18, .28], [0.18, .28], (.80, .28, .28) \rangle \\ \Phi_2 & \langle [0.45, .58], [0.35, .45], [0.35, .47], (.58, .45, .47) \rangle & \langle [0.50, .64], [0.30, .40], [0.30, .40], (.64, .40, .40) \rangle & \langle [0.60, .76], [0.20, .30], [0.20, .30], (.76, .30, .30) \rangle \\ \Phi_3 & \langle [0.62, .80], [0.18, .28], [0.18, .28], (.80, .28, .28) \rangle & \langle [0.64, .84], [0.16, .26], [0.16, .32], (.84, .26, .32) \rangle & \langle [0.47, .60], [0.33, .43], [0.33, .47], (.60, .43, .47) \rangle \\ \Phi_4 & \langle [0.56, .73], [0.24, .34], [0.24, .41], (.73, .34, .41) \rangle & \langle [0.40, .50], [0.40, .50], [0.40, .50], (.50, .50, .50) \rangle & \langle [0.56, .73], [0.24, .34], [0.24, .37], (.73, .34, .37) \rangle \end{array} \right) \tag{16}$$

**Step: 4. Define the positive ideal solution and negative ideal solution**

The positive ideal solution  $a_{ij}^+ =$

$$\langle [0.62, .80], [0.18, .28], [0.18, .28], (.80, .28, .28) \rangle \langle [0.64, .84], [0.16, .26], [0.16, .32], (.84, .26, .32) \rangle \langle [0.62, .80], [0.18, .28], [0.18, .28], (.80, .28, .28) \rangle$$

and the negative ideal solution

$$a_{ij}^- =$$

$$\langle [0.44, .56], [0.36, .46], [0.36, .51], (.56, .46, .50) \rangle \langle [0.40, .50], [0.40, .50], [0.40, .50], (.50, .50, .50) \rangle \langle [0.47, .60], [0.33, .43], [0.33, .43], (.60, .43, .47) \rangle$$

**Step: 5. Compute  $\Gamma_i$  and  $Z_i$**

Using Equation (9) and Equation (10), we obtain

$$\Gamma_1 = \left( \frac{0.36 \times 0.2}{0.37} \right) + \left( \frac{0.37 \times 0.16}{0.25} \right) + \left( \frac{0.27 \times 0}{0.16} \right) = 0.43, \quad \Gamma_2 = \left( \frac{0.36 \times 0.18}{0.37} \right) + \left( \frac{0.37 \times 0.14}{0.25} \right) + \left( \frac{0.27 \times 0.02}{0.16} \right) = 0.42,$$

$$\Gamma_3 = \left( \frac{0.36 \times 0}{0.37} \right) + \left( \frac{0.37 \times 0}{0.25} \right) + \left( \frac{0.27 \times 0.19}{0.16} \right) = 0.32, \quad \Gamma_4 = \left( \frac{0.36 \times 0.08}{0.37} \right) + \left( \frac{0.37 \times 0.25}{0.25} \right) + \left( \frac{0.27 \times 0.07}{0.16} \right) = 0.57.$$

$$\text{And } Z_1 = \max \left\{ \left( \frac{0.36 \times 0.2}{0.37} \right), \left( \frac{0.37 \times 0.16}{0.25} \right), \left( \frac{0.27 \times 0}{0.16} \right) \right\} = 0.24, \quad Z_2 = \max \left\{ \left( \frac{0.36 \times 0.18}{0.37} \right), \left( \frac{0.37 \times 0.14}{0.25} \right), \left( \frac{0.27 \times 0.02}{0.16} \right) \right\} = 0.21,$$

$$Z_3 = \max \left\{ \left( \frac{0.36 \times 0}{0.37} \right), \left( \frac{0.37 \times 0}{0.25} \right), \left( \frac{0.27 \times 0.19}{0.16} \right) \right\} = 0.32, \quad Z_4 = \max \left\{ \left( \frac{0.36 \times 0.08}{0.37} \right), \left( \frac{0.37 \times 0.25}{0.25} \right), \left( \frac{0.27 \times 0.07}{0.16} \right) \right\} = 0.37.$$

**Step: 6. Calculate the values of  $\phi_i$**

Using Equations (11), (12) and  $\gamma = 0.5$ , we obtain

$$\phi_1 = 0.5 \times \frac{(0.43 - 0.32)}{0.25} + 0.5 \times \frac{(0.24 - 0.21)}{0.16} = 0.31, \quad \phi_2 = 0.5 \times \frac{(0.42 - 0.32)}{0.25} + 0.5 \times \frac{(0.21 - 0.21)}{0.16} = 0.2,$$

$$\phi_3 = 0.5 \times \frac{(0.32 - 0.32)}{0.25} + 0.5 \times \frac{(0.32 - 0.21)}{0.16} = 0.34, \quad \phi_4 = 0.5 \times \frac{(0.57 - 0.32)}{0.25} + 0.5 \times \frac{(0.37 - 0.21)}{0.16} = 1.$$

**Step 7. Rank the priority of alternatives**

The preference ranking order of the alternatives is presented in Table 1

	$\Phi_1$	$\Phi_2$	$\Phi_3$	$\Phi_4$	Ranking order	Best alternative
$\Gamma$	0.43	0.42	0.32	0.57	$\Phi_3 \succ \Phi_2 \succ \Phi_1 \succ \Phi_4$	$\Phi_3$
$Z$	0.24	0.21	0.32	0.37	$\Phi_2 \succ \Phi_1 \succ \Phi_3 \succ \Phi_4$	$\Phi_2$
$\phi(\gamma=0.5)$	0.31	0.20	0.34	1	$\Phi_2 \succ \Phi_1 \succ \Phi_3 \succ \Phi_4$	$\Phi_2$

**Table 1** Preference ranking order and compromise solution based on  $\Gamma$ ,  $Z$  and  $\phi$

### Step 8. Determine the compromise solution

The preference ranking order based on  $\varphi$  in decreasing order and alternative with best position is  $\Phi_2$  with  $\varphi(\Phi_2) = 0.20$ , and second best position  $\Phi_1$  with  $\varphi(\Phi_1) = 0.31$ . Therefore,  $\varphi(\Phi_1) - \varphi(\Phi_2) = 0.11 < 0.333$  (since,  $r = 4$ ;  $1/(r-1) = 0.333$ ), which does not satisfy the condition 1

( $\varphi(\Phi_2) - \varphi(\Phi_1) \geq \frac{1}{(r-1)}$ ), but alternative  $\Phi_2$  is the best ranked by  $\Gamma, Z$ , which satisfies the condition 2.

Therefore, we obtain the compromise solution as follows:

$\varphi(\Phi_1) - \varphi(\Phi_2) = 0.11 < 0.333$ ,  $\varphi(\Phi_3) - \varphi(\Phi_2) = 0.14 < 0.333$ ,  $\varphi(\Phi_4) - \varphi(\Phi_2) = 0.80 > 0.333$ .

So  $\Phi_1, \Phi_2, \Phi_3$  are compromise solutions.

### 5. The influence of parameter $\gamma$

Table 2 shows how the ranking order of alternatives ( $\Phi_i$ ) changes with the change of the value of  $\gamma$

**Table 2.** Values of  $\phi_i$  ( $i = 1, 2, 3, 4$ ) and ranking of alternatives for different values of  $\gamma$ .

Values of $\gamma$	Values of $\phi_i$	Preference order of alternatives
$\gamma = 0.1$	$\phi_1 = 0.22, \phi_2 = \mathbf{0.04}, \phi_3 = 0.62, \phi_4 = 1$	$\Phi_2 \succ \Phi_1 \succ \Phi_3 \succ \Phi_4$
$\gamma = 0.2$	$\phi_1 = 0.24, \phi_2 = \mathbf{0.08}, \phi_3 = 0.55, \phi_4 = 1$	$\Phi_2 \succ \Phi_1 \succ \Phi_3 \succ \Phi_4$
$\gamma = 0.3$	$\phi_1 = 0.26, \phi_2 = \mathbf{0.12}, \phi_3 = 0.48, \phi_4 = 1$	$\Phi_2 \succ \Phi_1 \succ \Phi_3 \succ \Phi_4$
$\gamma = 0.4$	$\phi_1 = 0.29, \phi_2 = \mathbf{0.16}, \phi_3 = 0.41, \phi_4 = 1$	$\Phi_2 \succ \Phi_1 \succ \Phi_3 \succ \Phi_4$
$\gamma = 0.5$	$\phi_1 = 0.31, \phi_2 = \mathbf{0.2}, \phi_3 = 0.34, \phi_4 = 1$	$\Phi_2 \succ \Phi_1 \succ \Phi_3 \succ \Phi_4$
$\gamma = 0.6$	$\phi_1 = 0.34, \phi_2 = \mathbf{0.24}, \phi_3 = 0.28, \phi_4 = 1$	$\Phi_2 \succ \Phi_3 \succ \Phi_1 \succ \Phi_4$
$\gamma = 0.7$	$\phi_1 = 0.36, \phi_2 = 0.28, \phi_3 = \mathbf{0.21}, \phi_4 = 1$	$\Phi_3 \succ \Phi_2 \succ \Phi_1 \succ \Phi_4$
$\gamma = 0.8$	$\phi_1 = 0.39, \phi_2 = 0.32, \phi_3 = \mathbf{0.14}, \phi_4 = 1$	$\Phi_3 \succ \Phi_2 \succ \Phi_1 \succ \Phi_4$
$\gamma = 0.9$	$\phi_1 = 0.42, \phi_2 = 0.36, \phi_3 = \mathbf{0.07}, \phi_4 = 1$	$\Phi_3 \succ \Phi_2 \succ \Phi_1 \succ \Phi_4$

### 6. Conclusion

In this article, we have presented a modified NC-VIKOR strategy to overcome the shortcomings of obtaining compromise solution [73]. In the modified NC-VIKOR strategy, we have incorporated the technique of determining compromise solution. Finally, we solve an MAGDM problem to show the feasibility, applicability and efficiency. We present a sensitivity analysis to show the impact of different values of the decision making mechanism coefficient on ranking order of the alternatives.

## References

- [1] F. Smarandache. A unifying field of logics. *Neutrosophy: neutrosophic probability, set and logic*, American Research Press, Rehoboth, (1998).
- [2] L. A. Zadeh. Fuzzy sets. *Information and Control*, 8 (3) (1965), 338-353.
- [3] K. T. Atanassov. Intuitionistic fuzzy sets. *Fuzzy Sets and Systems*, 20 (1986), 87-96.
- [4] H. Wang, F. Smarandache, Y. Zhang, and R. Sunderraman. Single valued neutrosophic sets. *Multi-space and Multi-structure*, 4 (2010), 410-413.
- [5] S. Pramanik, and T. K. Roy. Neutrosophic game theoretic approach to Indo-Pak conflict over Jammu-Kashmir. *Neutrosophic Sets and Systems*, 2 (2014), 82-101.
- [6] J. Ye. Single valued neutrosophic minimum spanning tree and its clustering method. *Journal of Intelligent Systems*, 23 (2014), 311–324.
- [7] J. Ye. Clustering methods using distance-based similarity measures of single-valued neutrosophic sets. *Journal of Intelligent Systems*, 23(2014), 379–389.
- [8] Y. Guo, and A. Sengur. NCM: Neutrosophic c-means clustering algorithm. *Pattern Recognition*, 48 (8) (2015), 2710-2724.
- [9] R. Şahin, Neutrosophic hierarchical clustering algoritms. *Neutrosophic Sets and Systems*, 2 (2014), 18-24.
- [10] P. Biswas, S. Pramanik, and B. C. Giri. Entropy based grey relational analysis method for multi-attribute decision making under single valued neutrosophic assessments. *Neutrosophic Sets and Systems*, 2 (2014), 102–110.
- [11] P. Biswas, S. Pramanik, and B. C. Giri. A new methodology for neutrosophic multi-attribute decision making with unknown weight information. *Neutrosophic Sets and Systems*, 3 (2014), 42–52.
- [12] P. Biswas, S. Pramanik, and B. C. Giri. TOPSIS method for multi-attribute group decision-making under single valued neutrosophic environment. *Neural Computing and Applications*, (2015). doi: 10.1007/s00521-015-1891-2.
- [13] P. Biswas, S. Pramanik, and B. C. Giri. Aggregation of triangular fuzzy neutrosophic set information and its application to multi-attribute decision making. *Neutrosophic Sets and Systems*, 12 (2016), 20-40.
- [14] P. Biswas, S. Pramanik, and B. C. Giri. Value and ambiguity index based ranking method of single-valued trapezoidal neutrosophic numbers and its application to multi-attribute decision making. *Neutrosophic Sets and Systems* 12 (2016), 127-138.
- [15] P. Biswas, S. Pramanik, and B. C. Giri. Multi-attribute group decision making based on expected value of neutrosophic trapezoidal numbers. *New Trends in Neutrosophic Theory and Applications-Vol-II*. Pons Editions, Brussels (2017). In Press.
- [16] P. Biswas, S. Pramanik, and B. C. Giri. Non-linear programming approach for single-valued neutrosophic TOPSIS method. *New Mathematics and Natural Computation*, (2017). In Press.
- [17] K. Mondal, S. Pramanik, B. C. Giri. Single valued neutrosophic hyperbolic sine similarity measure based strategy for MADM problems. *Neutrosophic Sets and Systems*, 20 (2018), 03-11.
- [18] S. Pramanik, S. Dalapati, and T. K. Roy. Neutrosophic multi-attribute group decision making strategy for logistic center location selection. In F. Smarandache, M. A. Basset & V. Chang (Eds.), *Neutrosophic Operational Research*, Vol. III. Pons Asbl, Brussels, 2018, 13-32.
- [19] A. Kharal. A neutrosophic multi-criteria decision making method. *New Mathematics and Natural Computation*, 10 (2014), 143–162.
- [20] R. X. Liang, J. Q. Wang, and L. Li. Multi-criteria group decision making method based on interdependent inputs of single valued trapezoidal neutrosophic information. *Neural Computing and Applications*, (2016). doi:10.1007/s00521-016-2672-2.
- [21] K. Mondal, and S. Pramanik. Neutrosophic decision making model for clay-brick selection in construction field based on grey relational analysis. *Neutrosophic Sets and Systems*, 9 (2015), 64-71.
- [22] K. Mondal, S. Pramanik, and B. C. Giri. Hybrid binary logarithm similarity measure for MAGDM problems under SVN assessments. *Neutrosophic Sets and Systems*, 20 (2018), 12-25.
- [23] P. D. Liu, and H. G. Li. Multiple attribute decision-making method based on some normal neutrosophic Bonferroni mean operators. *Neural Computing and Applications*, 28 (2017), 179–194.
- [24] P. Liu, and Y. Wang. Multiple attribute decision-making method based on single-valued neutrosophic normalized weighted Bonferroni mean. *Neural Computing and Applications*, 25(7) (2014), 2001–2010.
- [25] J. J. Peng, J. Q. Wang, J. Wang, H. Y. Zhang, and X. H. Chen. Simplified neutrosophic sets and their applications in multi-criteria group decision-making problems. *International Journal of Systems Science*, 47 (10) (2016), 2342-2358.
- [26] J. Peng, J. Wang, H. Zhang, and X. Chen. An outranking approach for multi-criteria decision-making problems with simplified neutrosophic sets. *Applied Soft Computing*, 25, 336–346.
- [27] S. Pramanik, D. Banerjee, and B. C. Giri. Multi –criteria group decision making model in neutrosophic refined set and its application. *Global Journal of Engineering Science and Research Management*, 3 (6) (2016), 12-18.
- [28] S. Pramanik, S. Dalapati, and T. K. Roy. Logistics center location selection approach based on neutrosophic multi-criteria decision making. In F. Smarandache, & S. Pramanik (Eds), In F. Smarandache, & S. Pramanik (Eds), *New trends in neutrosophic theory and applications* (pp. 161-174). Brussels: Pons Editions, 2016.
- [29] R. Sahin, and M. Karabacak. A multi attribute decision making method based on inclusion measure for interval neutrosophic sets. *International Journal of Engineering and Applied Sciences*, 2 (2) (2014), 13–15.

- [30] R. Sahin, and A. Kucuk. Subsethood measure for single valued neutrosophic sets. *Journal of Intelligent and Fuzzy System*, (2014). doi:10.3233/IFS-141304.
- [31] R. Sahin, and P. Liu. Maximizing deviation method for neutrosophic multiple attribute decision making with incomplete weight information. *Neural Computing and Applications*, (2015), doi: 10.1007/s00521-015-1995-8.
- [32] P. Biswas. Multi-attribute decision making in neutrosophic environment. Ph. D. Thesis. Jadavpur University (2017), India.
- [33] J. Ye. Multicriteria decision-making method using the correlation coefficient under single-valued neutrosophic environment. *International Journal of General Systems*, 42 (2013), 386–394.
- [34] J. Ye. Single valued neutrosophic cross-entropy for multi criteria decision making problems. *Applied Mathematical Modelling*, 38 (3) (2013), 1170–1175.
- [35] J. Ye. A multi criteria decision-making method using aggregation operators for simplified neutrosophic sets. *Journal of Intelligent and Fuzzy Systems*, 26 (2014), 2459–2466.
- [36] F. Smarandache, and S. Pramanik, (Eds). *New trends in neutrosophic theory and applications*. Brussels: Pons Editions, 2016.
- [37] F. Smarandache, and S. Pramanik, (Eds). *New trends in neutrosophic theory and applications. Vol. II*. Brussels: Pons Editions, 2018.
- [38] J. Ye. Projection and bidirectional projection measures of single valued neutrosophic sets and their decision – making method for mechanical design scheme. *Journal of Experimental and Theoretical Artificial Intelligence*, (2016). doi:10.1080/0952813X.2016.1259263.
- [39] S. Pramanik, S. Dalapati, S. Alam, F. Smarandache, and T. K. Roy. NS-cross entropy-based MAGDM under single-valued neutrosophic set environment. *Information*, 9(2) (2018), 37.
- [40] K. Mondal, and S. Pramanik. Multi-criteria group decision making approach for teacher recruitment in higher education under simplified Neutrosophic environment. *Neutrosophic Sets and Systems*, 6 (2014), 28-34.
- [41] K. Mondal, and S. Pramanik. Neutrosophic decision making model of school choice. *Neutrosophic Sets and Systems*, 7 (2015), 62-68.
- [42] H. D. Cheng, and Y. Guo. A new neutrosophic approach to image thresholding. *New Mathematics and Natural Computation*, 4 (2008), 291–308.
- [43] Y. Guo, and H. D. Cheng. New neutrosophic approach to image segmentation. *Pattern Recognition*, 42 (2009), 587–595.
- [44] Y. Guo, A. Sengur, and J. Ye. A novel image thresholding algorithm based on neutrosophic similarity score. *Measurement*, 58 (2014), 175–186.
- [45] M. Zhang, L. Zhang, and H. D. Cheng. A neutrosophic approach to image segmentation based on watershed method. *Signal Processing*, 90 (5) (2010), 1510-1517.
- [46] J. Ye. Improved cosine similarity measures of simplified neutrosophic sets for medical diagnoses. *Artificial Intelligence in Medicine*, 63 (2015), 171–179.
- [47] S. Ye, and J. Ye. Dice similarity measure between single valued neutrosophic multi sets and its application in medical diagnosis. *Neutrosophic Sets and System*, 6 (2014), 49-54.
- [48] K. Mondal, and S. Pramanik. A study on problems of Hijras in West Bengal based on neutrosophic cognitive maps. *Neutrosophic Sets and Systems*, 5(2014), 21-26.
- [49] S. Pramanik, and S. Chakrabarti. A study on problems of construction workers in West Bengal based on neutrosophic cognitive maps. *International Journal of Innovative Research in Science. Engineering and Technology*, 2(11) (2013), 6387-6394.
- [50] H. Wang, F. Smarandache, Y. Q. Zhang, and R. Sunderraman. *Interval Neutrosophic Sets and Logic: Theory and Applications in Computing*; Hexis: Phoenix, AZ, USA, 2005.
- [51] K. Mondal, S. Pramanik, and B. C. Giri. Interval neutrosophic tangent similarity measure based MADM strategy and its application to MADM problems. *Neutrosophic Sets and Systems*, 19 (2018), 47-56.
- [52] S. Dalapati, S. Pramanik, S. Alam, F. Smarandache, and T. K. Roy. IN-cross entropy based MAGDM strategy under interval neutrosophic set environment. *Neutrosophic Sets and Systems*, 18 (2017), 43-57.
- [53] M. Ali, I. Deli, and F. Smarandache. The theory of neutrosophic cubic sets and their applications in pattern recognition. *Journal of Intelligent & Fuzzy Systems*, 30 (4) (2016), 1957-1963.
- [54] J. Zhan, M. Khan, M. Gulistan, and A. Ali. Applications of neutrosophic cubic sets in multi-criteria decision making. *International Journal for Uncertainty Quantification*, 7(5) (2017), 377–394.
- [55] D. Banerjee, B. C. Giri, S. Pramanik, and F. Smarandache. GRA for multi attribute decision making in neutrosophic cubic set environment. *Neutrosophic Sets and Systems*, 15 (2017), 60-69.
- [56] Z. Lu, and J. Ye. Cosine measures of neutrosophic cubic sets for multiple attribute decision-making. *Symmetry* 9 (7) (2017), 121.
- [57] S. Pramanik, S. Dalapati, S. Alam, and T. K. Roy, and F. Smarandache. Neutrosophic cubic MCGDM method based on similarity measure. *Neutrosophic Sets and Systems*, 16, (2017), 44-56.
- [58] S. Pramanik, S. Dalapati, S. Alam, and T. K. Roy. NC-TODIM-Based MAGDM under a Neutrosophic Cubic Set Environment. *Information* 8 (4) (2017), 149.
- [59] L. Shi, and J. Ye. Dombi aggregation operators of neutrosophic cubic sets for multiple attribute decision-making. *Algorithms*, 11 (3), 29, (2018). doi:10.3390/a11030029

- [60] S. Pramanik, P. P. Dey, B. C. Giri, and F. Smarandache. An extended TOPSIS for multi-attribute decision making problems with neutrosophic cubic information. *Neutrosophic Sets and Systems*, 17 (2017), 20-28.
- [61] J. Ye. Operations and aggregation method of neutrosophic cubic numbers for multiple attribute decision-making. <https://books.google.co.in/books?id=GhRPDwAAQBAJ>.
- [62] S. Pramanik, S. Dalapati, S. Alam, and T. K. Roy. Some operations and properties of neutrosophic cubic soft set. *Global Journal of Research and Review*, 4 (2) (2017).
- [63] S. Opricovic. *Multicriteria Optimization of Civil Engineering Systems*; Faculty of Civil Engineering: Belgrade, Serbia, 1998.
- [64] S. Opricovic, G. H. Tzeng. Compromise solution by MCDM methods: A comparative analysis of VIKOR and TOPSIS. *European journal of operational research*, 156 (2004), 445–455.
- [65] S. Opricovic, G. H. Tzeng. Extended VIKOR method in comparison with outranking methods. *European journal of operational research*, 178 (2) (2007), 514-529.
- [66] R. Bausys, and E. K. Zavadskas. Multicriteria decision making approach by VIKOR under interval neutrosophic set environment. *Economic Computation and Economic Cybernetics Studies and Research*, 4 (2015), 33-48.
- [67] Y. Huang, G. Wei, and C. Wei. VIKOR method for interval neutrosophic multiple attribute group decision-making. *Information*, 8 (2017), 144. doi:10.3390/info8040144.
- [68] H. Poursmaeil, E. Shivanian, E. Khorram, and H. S. Fathabadi. An extended method using TOPSIS and VIKOR for multiple attribute decision making with multiple decision makers and single valued neutrosophic numbers. *Advances and Applications in Statistics*, 50 (4) (2017), 261.
- [69] P. Liu, L. Zhang. The extended VIKOR method for multiple criteria decision making problem based on neutrosophic hesitant fuzzy set, (2014).
- [70] J. Hu, L. Pan, and X. Chen. An interval neutrosophic projection-based VIKOR method for selecting doctors. *Cognitive Computation*, 9(6) (2017), 801-816.
- [71] K. Selvakumari, and M. A. Priyadharshini. VIKOR method for decision making problem using octagonal neutrosophic soft matrix. *International Journal of Latest Engineering Research and Applications*, 2(7) (2017), 41-45.
- [72] S. Pramanik, S. Dalapati, S. Alam, and T. K. Roy. VIKOR based MAGDM strategy under bipolar neutrosophic set environment. *Neutrosophic Sets and Systems*, 19 (2018), 57-69.
- [73] S. Pramanik, S. Dalapati, S. Alam, and T. K. Roy. NC-VIKOR based MAGDM under Neutrosophic Cubic Set Environment. *Neutrosophic Sets and Systems*, 20 (2018), 95-108.
- [74] J. Ye. Similarity measures between interval neutrosophic sets and their applications in multi criteria decision-making. *Journal of Intelligent and Fuzzy Systems*, 26 (2014), 165–172.

Received: August 6, 2018. Accepted: August 29, 2018.



# Divergence Measure of Neutrosophic Sets and Applications

Nguyen Xuan Thao<sup>1</sup>, Florentin Smarandache<sup>2</sup>

<sup>1</sup>Faculty of Information Technology, Vietnam National University of Agriculture. Ha Noi, Viet Nam.  
Email: nxthao@vnua.edu.vn

<sup>2</sup>Mathematics & Science Department, University of New Mexico. 705 Gurley Ave., Gallup, NM 87301, USA.  
Email: smarand@unm.edu

**Abstract:** In this paper, we first propose the concept of divergence measure on neutrosophic sets. We also provide some formulas for the divergence measure for neutrosophic sets. After that, we investigate the properties of proposed neutrosophic divergence measure. Finally, we also apply these formulas in medical problem and the classification problem.

**Keywords:** neutrosophic set, divergence measure, classification problem.

## 1 Introduction

The neutrosophic set [25] was first introduced by Smarandache as an extension of intuitionistic fuzzy set [1] and fuzzy set [36]. It is a useful mathematical tool for dealing with ambiguous and inaccurate problems [4-6, 10, 24, 26-35, 37]. So far, many theoretical and applied results have been exploited on neutrosophic sets as the similarity/distance measures of neutrosophic sets [7-9, 11, 17-19, 22]. Neutrosophic set is applied in the multi-criteria decision making (MCDM) problem [4-6, 10-16, 23]. A special case of neutrosophic set is Single valued neutrosophic set (SVNS) which introduced by Wang et al [29]. In 2014, Ye proposed distance-based similarity measures of single valued neutrosophic sets and their multiple attribute group decision making method [32]. In 2017, Ye studied cotangent similarity measures for single-valued neutrosophic sets and applied it in the MCDM problem and in the fault diagnosis of steam turbine [34].

In the study of the applications of fuzzy set theory, the measurements are focused heavily on research. Measurements are often used to measure the degree of similarity or dissimilarity between objects. One of the dissimilarity measures of fuzzy sets/intuitionistic fuzzy sets was recently investigated by investigators as a measure of the divergence of fuzzy sets [3, 12, 20, 21]. Divergence measures also have many applications in practical problem classes and give us interesting results [3, 12, 20, 21]. Some authors have applied divergence measure to determine the relationship between the patient and the treatment regimen based on symptoms, thereby selecting the most appropriate treatment regimen for each patient [3]. Divergence measure is also used in multi-criterion decision problems [3, 12, 20, 21].

In this paper, we introduce the concept of divergence measure of neutrosophic sets, called neutrosophic divergence measure. We also give some expressions that define the neutrosophic divergence measures. After that, we investigate the properties of them. Finally, we use these neutrosophic divergence measure to identify appropriate treatment regimens for each patient and use them in the sample recognition problem.

The article is organized as follows: In section 2, we recall the knowledge related to neutrosophic sets. In section 3, we introduce the concept of neutrosophic divergence measure and investigate their properties. We show some applications of neutrosophic divergence measures in section 4. In section 5, we give conclusion on neutrosophic divergence measure and its some development direction.

## 2 Preliminary

**Definition 1.** Neutrosophic set (NS) [28]:

$$A = \{(x, T_A(x), I_A(x), F_A(x)) \mid x \in U\} \tag{1}$$

where  $T_A(x) \in [0,1]$  is a trust membership function,  $I_A(x) \in [0,1]$  is indeterminacy membership function,  $F_A(x) \in [0,1]$  is falsity-membership function of  $A$ .

We denote  $NS(U)$  is a collection of neutrosophic set on  $U$ . In which

$$U = \{(u, 1, 1, 0) \mid u \in U\}$$

and

$$\emptyset = \{(u, 0, 0, 1) \mid u \in U\}$$

For two set  $A, B \in NS(U)$  we have:

- Union of  $A$  and  $B$ :

$$A \cup B = \{(x, T_{A \cup B}(x), I_{A \cup B}(x), F_{A \cup B}(x))\}$$

where

$$T_{A \cup B}(x) = \max(T_A(x), T_B(x)),$$

$$I_{A \cup B}(x) = \min(I_A(x), I_B(x))$$

and

$$F_{A \cup B}(x) = \min(F_A(x), F_B(x))$$

for all  $x \in X$ .

- Intersection of  $A$  and  $B$ :

$$A \cap B = \{(x, T_{A \cap B}(x), I_{A \cap B}(x), F_{A \cap B}(x))\}$$

where

$$T_{A \cap B}(x) = \min(T_A(x), T_B(x)),$$

$$I_{A \cap B}(x) = \max(I_A(x), I_B(x))$$

and

$$F_{A \cap B}(x) = \max(F_A(x), F_B(x))$$

for all  $x \in X$ .

- Subset:  $A \subseteq B$  if only if

$$T_A(x) \leq T_B(x), I_A(x) \geq I_B(x), F_A(x) \geq F_B(x)$$

for all  $x \in X$ .

- Equal set:  $A = B$  if only if  $A \subseteq B$  and  $B \subseteq A$ .

- Complement of  $A$ :

$$A^C = \{(x, F_A(x), 1 - I_A(x), T_A(x)) \mid x \in U\}$$

### 3 Divergence measures of neutrosophic sets

**Definition 2.** Let  $A$  and  $B$  be two neutrosophic sets on  $U$ . A function  $D : NS(U) \times NS(U) \rightarrow R$  is a divergence measure of neutrosophic sets if it satisfies the following conditions:

Div1.  $D(A, B) = D(B, A)$ ,

Div2.  $D(A, B) = 0$  iff  $A = B$



Div3.  $D(A \cap C, B \cap C) \leq D(A, B)$  for all  $C \in NS(U)$ ,

Div4.  $D(A \cup C, B \cup C) \leq D(A, B)$  for all  $C \in NS(U)$ .

We can easily verify that the divergence measures of neutrosophic sets are non-negative. Because, if we choose  $C = \emptyset$  then conditions Div2 and Div3 in definition 2, then we have

$$D(A, B) \geq D(A \cap C, B \cap C) = D(\emptyset, \emptyset) = 0.$$

Now we give some divergence measures of Neutrosophic sets and their properties.

**Definition 3.** Let  $A$  and  $B$  be two neutrosophic sets on  $U = \{u_1, u_2, \dots, u_n\}$ . A function  $D : NS(U) \times NS(U) \rightarrow R$  is defined as follows

$$D(A, B) = \frac{1}{n} \sum_{i=1}^n [D_T^i(A, B) + D_I^i(A, B) + D_F^i(A, B)] \quad (2)$$

where

$$D_T^i(A, B) = T_A(u_i) \ln \frac{2T_A(u_i)}{T_A(u_i) + T_B(u_i)} + T_B(u_i) \ln \frac{2T_B(u_i)}{T_A(u_i) + T_B(u_i)} \quad (3)$$

$$D_I^i(A, B) = I_A(u_i) \ln \frac{2I_A(u_i)}{I_A(u_i) + I_B(u_i)} + I_B(u_i) \ln \frac{2I_B(u_i)}{I_A(u_i) + I_B(u_i)} \quad (4)$$

and

$$D_F^i(A, B) = F_A(u_i) \ln \frac{2F_A(u_i)}{F_A(u_i) + F_B(u_i)} + F_B(u_i) \ln \frac{2F_B(u_i)}{F_A(u_i) + F_B(u_i)}. \quad (5)$$

To proof that  $D(A, B)$  is a divergence measure of neutrosophic sets we need some following lemma.

**Lemma 1.** Given  $a \in (0, 1]$ . For all  $z \in [0, 1 - a]$  then

$$f(z) = a \ln 2a + (a + z) \ln(2a + 2z) - (2a + z) \ln(2a + z) \quad (6)$$

is a non-decreasing function and  $f(z) \geq 0$ .

*Proof.*

We obtain  $\frac{\partial f(z)}{\partial z} = \ln(2a + 2z) - \ln(2a + z) \geq 0$  for all  $z \in [0, 1 - a]$ .  $\square$

**Lemma 2.** Given  $b \in (0, 1]$ . For all  $z \in (0, b]$  then

$$f(z) = b \ln 2b + z \ln 2z - (b + z) \ln(b + z) \quad (7)$$

is a non-increasing function and  $f(z) \geq 0$ .

*Proof.*

We have  $\frac{\partial f(z)}{\partial z} = \ln 2z - \ln(b + z) \leq 0$  for all  $z \in (0, b]$ .  $\square$

**Lemma 3.** Given  $a \in (0, 1]$ . For all  $z \in [a, 1]$  then

$$f(z) = a \ln 2a - (a + z) \ln(a + z) + z \ln 2z \quad (8)$$

is a non-decreasing function and  $f(z) \geq 0$ .

*Proof.*

We have  $\frac{\partial f(z)}{\partial z} = \ln 2z - \ln(a + z) \geq 0$  for all  $z \in [a, 1]$ .  $\square$

**Theorem 1.** The function  $D(A, B)$  defined by eq (2, 3, 4, 5) (in definition 3) is a divergence measure of two Neutrosophic sets.

*Proof.*

We check the conditions of the definition. For two Neutrosophic sets  $A$  and  $B$  on  $U$ , we have:

- Div1:  $D(A, B) = D(B, A)$ ,
- Div2:

+ If  $A = B$  we have  $D_T^i(A, B) = D_I^i(A, B) = D_F^i(A, B) = 0$ . So that  $D(A, B) = 0$ .

+ Assume that

$$D(A, B) = \frac{1}{n} \sum_{i=1}^n [D_T^i(A, B) + D_I^i(A, B) + D_F^i(A, B)] = 0$$

For each  $u_i \in U$  we have  $T_A(u_i) \leq T_B(u_i)$  (or  $T_A(u_i) \leq T_B(u_i)$ ). So that, using Lemma 1 with  $a = T_A(u_i), z = T_B(u_i) - T_A(u_i)$  (if  $T_A(u_i) \leq T_B(u_i)$ ) we have

$$\begin{aligned} f(z) &= a \ln 2a + (a+z) \ln(2a+2z) - (2a+z) \ln(2a+z) \\ &= a \ln \frac{2a}{2a+z} + (a+z) \ln \frac{2(a+z)}{2a+z} \geq 0 \end{aligned}$$

We obtain

$$D_T^i(A, B) = T_A(u_i) \ln \frac{2T_A(u_i)}{T_A(u_i) + T_B(u_i)} + T_B(u_i) \ln \frac{2T_B(u_i)}{T_A(u_i) + T_B(u_i)} \geq 0$$

and  $D_T^i(A, B) = 0$  if only if  $z = T_B(u_i) - T_A(u_i) = 0$  i.e.  $T_B(u_i) = T_A(u_i)$ .

By same way, we also obtain  $D_I^i(A, B) \geq 0$  and  $D_I^i(A, B) = 0$  if only if  $I_B(u_i) = I_A(u_i)$ ;  $D_F^i(A, B) \geq 0$  and  $D_F^i(A, B) = 0$  if only if  $F_B(u_i) = F_A(u_i)$ . Those imply that  $D(A, B) = 0$  if only if  $A = B$ .

- Div3. For all  $C \in NS(U)$  and for all  $u_i \in U, (i = 1, 2, \dots, n)$ . Because of the symmetry of divergence measures, we can consider the following cases:

- With falsity-membership function we have:

+ If  $T_A(u_i) \leq T_B(u_i) \leq T_C(u_i)$  then  $T_{A \cap C}(u_i) = T_A(u_i)$  and  $T_{B \cap C}(u_i) = T_B(u_i)$  so that

$$\begin{aligned} &D_T^i(A \cap C, B \cap C) \\ &= T_{A \cap C}(u_i) \ln \frac{2T_{A \cap C}(u_i)}{T_{A \cap C}(u_i) + T_{B \cap C}(u_i)} + T_{B \cap C}(u_i) \ln \frac{2T_{B \cap C}(u_i)}{T_{A \cap C}(u_i) + T_{B \cap C}(u_i)} \\ &= T_A(u_i) \ln \frac{2T_A(u_i)}{T_A(u_i) + T_B(u_i)} + T_B(u_i) \ln \frac{2T_B(u_i)}{T_A(u_i) + T_B(u_i)} \\ &= D_T^i(A, B) \end{aligned}$$

+ If  $T_A(u_i) \leq T_C(u_i) \leq T_B(u_i)$  then  $T_{A \cup C}(u_i) = T_C(u_i)$  and  $T_{B \cup C}(u_i) = T_B(u_i)$ . So that, according the lemma 3 with  $a = T_A(u_i)$ , we have

$$\begin{aligned} &D_T^i(A \cap C, B \cap C) \\ &= T_A(u_i) \ln \frac{2T_A(u_i)}{T_A(u_i) + T_C(u_i)} + T_C(u_i) \ln \frac{2T_C(u_i)}{T_A(u_i) + T_C(u_i)} \end{aligned}$$

$$\leq T_A(u_i) \ln \frac{2T_A(u_i)}{T_A(u_i) + T_B(u_i)} + T_C(u_i) \ln \frac{2T_B(u_i)}{T_A(u_i) + T_B(u_i)}$$

$$= D_T^i(A, B)$$

+ If  $T_C(u_i) \leq T_A(u_i) \leq T_B(u_i)$  then  $T_{A \cap C}(u_i) = T_{B \cap C}(u_i) = T_C(u_i)$  and  $T_B(u_i) = T_C(u_i) + z$  with  $z \in [0, 1 - T_A(u_i)]$  so that according the lemma 1 we have

$$D_T^i(A \cap C, B \cap C)$$

$$= T_C(u_i) \ln \frac{2T_C(u_i)}{T_C(u_i) + T_C(u_i)} + T_C(u_i) \ln \frac{2T_C(u_i)}{T_C(u_i) + T_C(u_i)} = 0$$

$$\leq T_A(u_i) \ln \frac{2T_A(u_i)}{2T_A(u_i) + z} + T_B(u_i) \ln \frac{2T_A(u_i) + 2z}{2T_A(u_i) + z}$$

$$= T_A(u_i) \ln \frac{2T_A(u_i)}{T_A(u_i) + T_B(u_i)} + T_B(u_i) \ln \frac{2T_B(u_i)}{T_A(u_i) + T_B(u_i)}$$

$$= D_T^i(A, B).$$

- With indeterminacy membership function: we prove similarly to the case of falsity-membership function.

- With falsity membership function, we have:

+ If  $F_A(u_i) \leq F_B(u_i) \leq F_C(u_i)$  then  $F_{A \cap C}(u_i) = F_C(u_i)$  and  $F_{B \cap C}(u_i) = F_C(u_i)$  so that according lemma 1 we have

$$D_F^i(A \cap C, B \cap C)$$

$$= F_{A \cap C}(u_i) \ln \frac{2F_{A \cap C}(u_i)}{F_{A \cap C}(u_i) + F_{B \cap C}(u_i)} + F_{B \cap C}(u_i) \ln \frac{2F_{B \cap C}(u_i)}{F_{A \cap C}(u_i) + F_{B \cap C}(u_i)}$$

$$= F_C(u_i) \ln \frac{2F_C(u_i)}{F_C(u_i) + F_C(u_i)} + F_C(u_i) \ln \frac{2F_C(u_i)}{F_C(u_i) + F_C(u_i)} = 0$$

$$\leq F_A(u_i) \ln \frac{2F_B(u_i)}{F_A(u_i) + F_B(u_i)} + F_B(u_i) \ln \frac{2F_B(u_i)}{F_A(u_i) + F_B(u_i)}$$

$$= D_F^i(A, B)$$

+ If  $F_A(u_i) \leq F_C(u_i) \leq F_B(u_i)$  then  $F_{A \cup C}(u_i) = F_C(u_i)$  and  $F_{B \cup C}(u_i) = F_B(u_i)$ . So that, according the lemma 2 with  $b = F_B(u_i)$  we have

$$D_F^i(A \cap C, B \cap C)$$

$$= F_C(u_i) \ln \frac{2F_C(u_i)}{F_C(u_i) + F_B(u_i)} + F_B(u_i) \ln \frac{2F_B(u_i)}{F_C(u_i) + F_B(u_i)}$$

$$\leq F_A(u_i) \ln \frac{2F_A(u_i)}{F_A(u_i) + F_B(u_i)} + F_B(u_i) \ln \frac{2F_B(u_i)}{F_A(u_i) + F_B(u_i)}$$

$$= D_F^i(A, B).$$

+ If  $F_C(u_i) \leq F_A(u_i) \leq F_B(u_i)$  then according the lemma 1 we have

$$D_F^i(A \cap C, B \cap C)$$

$$= F_A(u_i) \ln \frac{2F_A(u_i)}{F_A(u_i) + F_B(u_i)} + F_B(u_i) \ln \frac{2F_B(u_i)}{F_A(u_i) + F_B(u_i)}$$

$$= D_F^i(A, B).$$

Now, we add that with respect to the respective components we have

$$\begin{aligned} & D(A \cap C, B \cap C) \\ &= \frac{1}{n} \sum_{i=1}^n [D_T^i(A \cap C, B \cap C) + D_I^i(A \cap C, B \cap C) + D_F^i(A \cap C, B \cap C)] \\ &\leq \frac{1}{n} \sum_{i=1}^n [D_T^i(A, B) + D_I^i(A, B) + D_F^i(A, B)] \\ &= D(A, B) \end{aligned}$$

- Div4. We perform as Div 3.  $\square$

Now we consider some properties of the divergence measures defined in definition 3.

**Theorem 2.** For all Neutrosophic set  $A, B \in PFS(U)$ . We have

(D1) For all  $A \subseteq B$ , or  $B \subseteq A$  we have

$$D(A \cap B, B) = D(A, A \cup B) \leq D(A, B),$$

(D2)  $D(A \cap B, A \cup B) = D(A, B)$ ,

(D3) For all  $A \subseteq B \subseteq C$  we have

$$D(A, B) \leq D(A, C),$$

(D4) For all  $A \subseteq B \subseteq C$  we have

$$D(B, C) \leq D(A, C).$$

Proof.

(D1). If  $A \subseteq B$  then  $D(A \cap B, B) = D(A, B)$  so that, we have

$$D(A, A \cup B) = D(A, B).$$

If  $B \subseteq A$  then  $D(A \cap B, B) = D(B, B) = 0$  so that, we have

$$D(A, A \cup B) = D(A, A) = 0.$$

It means that if  $A \subseteq B$ , or  $B \subseteq A$  we have

$$D(A \cap B, B) = D(A, A \cup B) \leq D(A, B).$$

(D2). Because of the symmetry of the divergence measure. We consider the cases:

+ If  $T_A(u_i) \leq T_B(u_i)$  then we have

$$\begin{aligned} & D_T^i(A \cup B, A \cap B) \\ &= T_B(u_i) \ln \frac{2T_B(u_i)}{T_A(u_i) + T_B(u_i)} + T_A(u_i) \ln \frac{2T_A(u_i)}{T_A(u_i) + T_B(u_i)} \\ &= D(A, B), \end{aligned}$$

+ if  $T_B(u_i) \leq T_A(u_i)$  then we have

$$\begin{aligned} & D_T^i(A \cup B, A \cap B) \\ &= T_A(u_i) \ln \frac{2T_A(u_i)}{T_A(u_i) + T_B(u_i)} + T_B(u_i) \ln \frac{2T_B(u_i)}{T_A(u_i) + T_B(u_i)} \\ &= D(A, B). \end{aligned}$$

By the same consideration for indeterminacy membership function and falsity membership function, we obtain

$$D(A \cap B, A \cup B) = D(A, B),$$

(D3). For all  $A \subseteq B \subseteq C$  and for all  $u_i \in U$  we have:

- With the falsity-membership function:

From condition  $T_A(u_i) \leq T_B(u_i) \leq T_C(u_i)$  and lemma 2 we have:

$$\begin{aligned} D_T^i(A, B) &= T_A(u_i) \ln \frac{2T_A(u_i)}{T_A(u_i) + T_B(u_i)} + T_B(u_i) \ln \frac{2T_B(u_i)}{T_A(u_i) + T_B(u_i)} \\ &= T_A(u_i) \ln \frac{2T_A(u_i)}{T_A(u_i) + T_C(u_i)} + T_C(u_i) \ln \frac{2T_C(u_i)}{T_C(u_i) + T_A(u_i)} \\ &= D_T^i(A, C), \end{aligned}$$

- With the indeterminacy membership function:

By the same way as falsity- membership function we have  $D_I^i(A, B) \leq D_I^i(A, C)$ ,

- With the falsity- membership function:

From condition  $F_A(u_i) \geq F_B(u_i) \geq F_C(u_i)$  and lemma 3 we have:

$$\begin{aligned} D_F^i(A, B) &= F_A(u_i) \ln \frac{2F_A(u_i)}{F_A(u_i) + F_B(u_i)} + F_B(u_i) \ln \frac{2F_B(u_i)}{F_A(u_i) + F_B(u_i)} \\ &\leq F_A(u_i) \ln \frac{2F_A(u_i)}{F_A(u_i) + F_C(u_i)} + F_C(u_i) \ln \frac{2F_C(u_i)}{F_A(u_i) + F_C(u_i)} \\ &= D_F^i(A, C). \end{aligned}$$

So that, we obtain the result  $D(A, B) \leq D(A, C)$ .

(D4). By the same way as (D4) using lemma 1, lemma 2 and lemma 3, it is easy to derive these results when considering specific cases.  $\square$

#### 4 Applications of divergence measure of Neutrosophic set

In this section we apply the Neutrosophic divergence measures in the medical diagnosis and classification problems.

##### 4.1 In the medical diagnosis

Now, we applied the Neutrosophic divergence measure for obtaining a proper diagnosis for the data given in Table 1 and Table 2. This data was modified from the data that introduced in [2]. Usage of diagnostic methods  $D = \{\text{Viral fever } (A_1), \text{ Malaria } (A_2), \text{ Typhoid } (A_3), \text{ Stomach problem } (A_4), \text{ Chest problem } (A_5)\}$  for patients with given values of symptoms  $S = \{\text{temperature } (s_1), \text{ headache } (s_2), \text{ stomach pain } (s_3), \text{ cough } (s_4), \text{ chest pain } (s_5)\}$ . In this case, the neutrosophic set is useful to handle them. Here, for each  $A_k \in D, (k = 1, 2, \dots, 5)$ , is expressed in form that is a neutrosophic set on the universal set  $S = \{s_1, s_2, s_3, s_4, s_5\}$ , see Table 1. The information of symptoms characteristic for the considered patients is given in Table 2. In which, for each patient  $B_j (j = 1, 2, 3, 4)$  is a neutrosophic set in the universal set  $S = \{s_1, s_2, s_3, s_4, s_5\}$ .

To select the appropriate diagnostic method we calculate the divergence measure between each patient and each diagnosis. After that, we chose the smallest value of them. This will be to give us the best diagnosis for each patient (Table 3).

The divergence measure of a diagnosis  $A_k \in D (k = 1, 2, \dots, 5)$  for each patient  $B_j (j = 1, 2, 3, 4)$  is computed by using the Eq.(2), Eq.(3), Eq.(4), Eq.(5) as follows:

$$D(A_k, B_j) = \frac{1}{n} \sum_{i=1}^n [D_T^i(A_k, B_j) + D_I^i(A_k, B_j) + D_F^i(A_k, B_j)]$$

where

$$D_T^i(A_k, B_j) = T_{A_k}(u_i) \ln \frac{2T_{A_k}(u_i)}{T_{A_k}(u_i) + T_{B_j}(u_i)} + T_{B_j}(u_i) \ln \frac{2T_{B_j}(u_i)}{T_{A_k}(u_i) + T_{B_j}(u_i)}$$

$$D_I^i(A_k, B_j) = I_{A_k}(u_i) \ln \frac{2I_{A_k}(u_i)}{I_{A_k}(u_i) + I_{B_j}(u_i)} + I_{B_j}(u_i) \ln \frac{2I_{B_j}(u_i)}{I_{A_k}(u_i) + I_{B_j}(u_i)}$$

and

$$D_F^i(A_k, B_j) = F_{A_k}(u_i) \ln \frac{2F_{A_k}(u_i)}{F_{A_k}(u_i) + F_{B_j}(u_i)} + F_{B_j}(u_i) \ln \frac{2F_{B_j}(u_i)}{F_{A_k}(u_i) + F_{B_j}(u_i)}$$

**Table 1.** Symptoms Characteristics for the Diagnosis

	Viral fever	Malaria	Typhoid	Stomach Problem	Chest Problem
Temperature	(0.7,0.5,0.6)	(0.7,0.9,0.1)	(0.3,0.7,0.2)	(0.1,0.6,0.7)	(0.1,0.9,0.8)
Headache	(0.8,0.2,0.9)	(0.4,0.5, 0.5)	(0.6,0.9,0.2)	(0.7,0.4,0.3)	(0.1,0.6,0.7)
Somach pain	(0.8,1,0.1)	(0.5,0.9,0.2)	(0.2,0.5,0.5)	(0.7,0.7,0.8)	(0.5,0.7,0.6)
Cough	(0.45,0.8,0.7)	(0.7,0.8,0.6)	(0.2,0.5,0.5)	(0.2,0.8,0.65)	(0.2,0.8,0.6)
Chest pain	(0.2,0.6,0.5)	(0.1,0.6,0.8)	(0.1,0.8,0.8)	(0.5,0.8,0.6)	(0.8,0.8,0.2)

**Table 2.** Symptoms Characteristics for the Patients

	Temperature	Headache	Stomach pain	Cough	Chest pain
Al ( $B_1$ )	(0.7,0.6,0.5)	(0.6,0.3,0.5)	(0.5,0.5,0.75)	(0.8,0.75,0.5)	(0.7,0.2,0.6)
Bob ( $B_2$ )	(0.7,0.3,0.5)	(0.5,0.5,0.8)	(0.6,0.5,0.5)	(0.65,0.4,0.75)	(0.2,0.85,0.65)
Joe ( $B_3$ )	(0.75,0.5,0.5)	(0.2,0.85,0.7)	(0.7,0.6,0.4)	(0.7,0.55,0.5)	(0.5,0.9,0.64)
Ted ( $B_4$ )	(0.4,0.7,0.6)	(0.7,0.5,0.7)	(0.6,0.7,0.5)	(0.5,0.9,0.65)	(0.6,0.5,0.85)

The computed results of the divergence measures are listed in Table 3. From the results, we see that Al and Ted should use diagnostic methods corresponding to Stomach Problem, Bob use a Viral fever, Joe use a Malaria.

**Table 3.** Diagnosis results for the divergence measure using eq. (2)

	Viral fever	Malaria	Typhoid	Stomach Problem	Chest Problem
Al	0.81614	0.82946	1.14558	<b>0.75326</b>	1.10798
Bob	<b>0.49750</b>	0.59104	0.73430	0.79456	1.14038
Joe	0.75011	<b>0.60603</b>	0.89659	0.88206	0.79920
Ted	0.48722	0.61785	0.81009	<b>0.36199</b>	0.72614

### 4.2 In the classification problem

Assume that, we have  $m$  pattern  $\{A_1, A_2, \dots, A_m\}$ , in which each pattern is a Neutrosophic set on universal set  $U = \{u_1, u_2, \dots, u_n\}$ . Suppose that, we have a sample  $B$  with the given feature information. Our goal is to classify sample B into which sample. To solve this, we calculate the divergence measure of  $B$  with each pattern  $A_i (i = 1, 2, \dots, m)$ . Then we choose the smallest value. It gives us the class that  $B$  belongs to.

**Example 1.** Assume that three are three Neutrosophic patterns in  $U = \{u_1, u_2, u_3\}$  as following

$$A_1 = \{(u_1, 0.7, 0.7, 0.2), (u_2, 0.7, 0.8, 0.4), (u_3, 0.6, 0.8, 0.2)\}$$

$$A_2 = \{(u_1, 0.5, 0.7, 0.3), (u_2, 0.7, 0.7, 0.5), (u_3, 0.8, 0.6, 0.1)\}$$

$$A_3 = \{(u_1, 0.9, 0.5, 0.1), (u_2, 0.7, 0.6, 0.4), (u_3, 0.8, 0.5, 0.2)\}$$

Assume that a sample

$$B = \{(u_1, 0.7, 0.8, 0.4), (u_2, 0.8, 0.5, 0.3), (u_3, 0.5, 0.8, 0.5)\}$$

Using the divergence measure in Eq.(2) we have  $D(A_1, B) = 0.15372$ ,  $D(A_2, B) = 0.26741$ ,  $D(A_3, B) = 0.29516$ .

So that we can classify that  $B$  belongs to class  $A_1$ .

## 5 Conclusion

Neutrosophic set theory is more and more interested by researchers. There are many theoretical and applied results on Neutrosophic sets that are built and developed. In this paper, we study the divergence measure of Neutrosophic sets. Along with that, we offer some divergence formulas on Neutrosophic sets and give some properties of these measurements. Finally we apply the proposed measures in some cases.

In the future, we will continue to study this measure and offer some of their applications in other areas such as image segmentation or multi-criteria decision making.

## References

- [1]. K. Atanassov. Intuitionistic Fuzzy Sets. Fuzzy set and systems. 20, 1986, 87-96.
- [2]. A. Aydođdu. On similarity and entropy of single valued neutrosophic sets. *Gen. Math. Notes*, 29(1), 2015, 67-74.
- [3]. S.K De, R. Biswas, A.R. Roy. An application of intuitionistic fuzzy sets in medical diagnosis. *Fuzzy sets and Systems*, 117(2), 209-213.
- [4]. P. Biswas, S. Pramanik, B.C. Giri. Entropy Based Grey Relational Analysis Method for Multi-Attribute Decision Making under Single Valued Neutrosophic Assessments, *Neutrosophic Sets and Systems*, vol. 2, 2014, pp. 102-110. doi.org/10.5281/zenodo.571363.
- [5]. P. Biswas, S. Pramanik, Bibhas C. Giri. A New Methodology for Neutrosophic Multi-Attribute Decision making with Unknown Weight Information, *Neutrosophic Sets and Systems*, vol. 3, 2014, pp. 42-50. doi.org/10.5281/zenodo.571212.
- [6]. P. Biswas, S. Pramanik, BC. Giri, (2016). TOPSIS method for multi-attribute group decision making under single-valued neutrosophic environment. *Neural computing and Applications*, 27 (3), 2016, 727-737.
- [7]. S. Broumi, F. Smarandache: Several Similarity Measures of Neutrosophic Sets, *Neutrosophic Sets and Systems*, vol. 1, 2013, pp. 54-62. doi.org/10.5281/zenodo.571755
- [8]. S. Broumi, F Smarandache. New distance and similarity measures of interval neutrosophic sets. (2014). *Infinite Study*.
- [9]. S. Broumi, F Smarandache. Extended hausdorff distance and similarity measures for neutrosophic refined sets and their application in medical diagnosis. *Journal of New Theory*, 7, 2015, 64-78.
- [10]. S. Dalapati, S. Pramanik, S. Alam, F. Smarandache, T. Roy. IN-cross Entropy Based MAGDM Strategy under Interval Neutrosophic Set Environment, *Neutrosophic Sets and Systems*, vol. 18, 2017, pp. 43-57. http://doi.org/10.5281/zenodo.1175162.
- [11]. H.L. Huang. New Distance Measure of Single-Valued Neutrosophic Sets and Its Application. *International Journal of Intelligent Systems*, 31(10), 2016, 1021-1032.
- [12]. A.R. Mishra, R. Kumari, D.K Sharma. Intuitionistic fuzzy divergence measure-based multi-criteria decision-making Method. *Neural Computing and Application*, 2017, 1-16.
- [13]. K. Mondal, S. Pramanik. Multi-criteria Group Decision Making Approach for Teacher Recruitment in Higher Education under Simplified Neutrosophic Environment, *Neutrosophic Sets and Systems*, vol. 6, 2014, pp. 28-34. doi.org/10.5281/zenodo.571479.
- [14]. K. Mondal, S. Pramanik. Neutrosophic Decision Making Model of School Choice, *Neutrosophic Sets and Systems*, vol. 7, 2015, pp. 62-68. doi.org/10.5281/zenodo.571507.
- [15]. K. Mondal, S. Pramanik. Neutrosophic Tangent Similarity Measure and Its Application to Multiple Attribute Decision Making, *Neutrosophic Sets and Systems*, vol. 9, 2015, pp. 80-87. doi.org/10.5281/zenodo.571578.
- [16]. K. Mondal, S. Pramanik. Neutrosophic Decision Making Model for Clay-Brick Selection in Construction Field Based on Grey Relational Analysis, *Neutrosophic Sets and Systems*, vol. 9, 2015, pp. 64-71. doi.org/10.5281/zenodo.34864.
- [17]. K. Mondal, S. Pramanik, B.C. Giri. Interval Neutrosophic Tangent Similarity Measure Based MADM strategy and its Application to MADM Problems, *Neutrosophic Sets and Systems*, vol. 19, 2018, pp. 46-56. http://doi.org/10.5281/zenodo.1235201.
- [18]. K. Mondal, S. Pramanik, B.C. Giri: Single Valued Neutrosophic Hyperbolic Sine Similarity Measure Based MADM Strategy, *Neutrosophic Sets and Systems*, vol. 20, 2018, pp. 3-11. http://doi.org/10.5281/zenodo.1235383.

- [19]. K. Mondal, S. Pramanik, B.C. Giri: Hybrid Binary Logarithm Similarity Measure for MAGDM Problems under SVNS Assessments, *Neutrosophic Sets and Systems*, vol. 20, 2018, pp. 12-25. <http://doi.org/10.5281/zenodo.1235365>
- [20]. I. Montes, N.R. Pal, V. Jani, S. Montes. Divergence measures for intuitionistic fuzzy sets. *IEEE Transactions on Fuzzy Systems* 23(2), 2015, 444-456.
- [21]. A. Ohlan. A new generalized fuzzy divergence measure and applications. *Fuzzy Information and Engineering* 7(4), 2015, 507-523.
- [22]. S. Pramanik, P. Biswas, B.C. Giri. Hybrid Vector Similarity Measures and Their Applications to Multi-attribute Decision Making under Neutrosophic Environment. *Neural Computing and Applications* 28 (5), 2017, 1163-1176. DOI 10.1007/s00521-015-2125-3
- [23]. S. Pramanik, S. Dalapati, S. Alam, F. Smarandache, and T.K. Roy. NS-cross entropy based MAGDM under single valued neutrosophic set environment. *Information*, 9(2), 2018, 37. doi:10.3390/info9020037.
- [24]. G. Shahzadi, M. Akram, A. B. Saeid. An Application of Single-Valued Neutrosophic Sets in Medical Diagnosis, *Neutrosophic Sets and Systems*, vol. 18, 2017, pp. 80-88. <http://doi.org/10.5281/zenodo.1175158>
- [25]. F. Smarandache. *Neutrosophy. Neutrosophic Probability, Set, and Logic*, ProQuest Information & Learning, Ann Arbor, Michigan, USA, 105 p., 1998; <http://fs.gallup.unm.edu/eBook-neutrosophics6.pdf> (last edition online);
- [26]. F. Smarandache, S. Pramanik, (Eds). *New trends in neutrosophic theory and applications*. Brussels: Pons Editions, 2016.
- [27]. F. Smarandache, S. Pramanik, (Eds). *New trends in neutrosophic theory and applications. Vol. II*. Brussels: Pons Editions, 2018.
- [28]. H. Wang, F. Smarandache, Y.Q. Zhang, R. Sunderraman. Single valued neutrosophic sets. *Multispace and Multistructure*, 4, 2014, 410-413.
- [29]. J. Ye: Another Form of Correlation Coefficient between Single Valued Neutrosophic Sets and Its Multiple Attribute Decision Making Method, *Neutrosophic Sets and Systems*, Vol. 1, 2013, pp. 8-12. doi.org/10.5281/zenodo.571265
- [30]. J. Ye and Q. Zhang: Single Valued Neutrosophic Similarity Measures for Multiple Attribute Decision-Making, *Neutrosophic Sets and Systems*, vol. 2, 2014, pp. 48-54. doi.org/10.5281/zenodo.571756.
- [31]. J. Ye Clustering methods using distance-based similarity measures of single-valued neutrosophic sets. *Journal of Intelligent Systems*, 23(4), 2014, 379-389.
- [32]. J. Ye. Multiple attribute group decision-making method with completely unknown weights based on similarity measures under single valued neutrosophic environment. *Journal of Intelligent & Fuzzy Systems*, 27(6), 2014, 2927-2935.
- [33]. S. Ye, J. Fu, and J. Ye. Medical diagnosis using distance-based similarity measures of single valued neutrosophic multisets. *Neutrosophic Sets and Systems*, 7, 2015, 47-52.
- [34]. J. Ye. Single-valued neutrosophic similarity measures based on cotangent function and their application in the fault diagnosis of steam turbine. *Soft Computing*, 21(3), 2017, 817-825.
- [35]. J. Ye. Single-valued neutrosophic clustering algorithms based on similarity measures. *Journal of Classification*, 34(1), 2017, 148-162.
- [36]. L.A. Zadeh. Fuzzy sets, *Information and control* 8(3), 1965, 338-353.
- [37]. Z. Zhang, Chong Wu: A novel method for single-valued neutrosophic multi-criteria decision making with incomplete weight information, *Neutrosophic Sets and Systems*, vol. 4, 2014, pp. 35-49. doi.org/10.5281/zenodo.571269
- [38] Arindam Dey, Said Broumi, Le Hoang Son, Assia Bakali, Mohamed Talea, Florentin Smarandache, "A new algorithm for finding minimum spanning trees with undirected neutrosophic graphs", *Granular Computing* (Springer), pp.1-7, 2018.
- [39] S Broumi, A Dey, A Bakali, M Talea, F Smarandache, LH Son, D Koley, "Uniform Single Valued Neutrosophic Graphs", *Neutrosophic sets and systems*, 2017.
- [40] S Broumi, A Bakali, M Talea, F Smarandache, A. Dey, LH Son, "Spanning tree problem with Neutrosophic edge weights", in *Proceedings of the 3rd International Conference on intelligence computing in data science*, Elsevier, science direct, *Procedia computer science*, 2018.
- [41] Said Broumi; Arindam Dey; Assia Bakali; Mohamed Talea; Florentin Smarandache; Dipak Koley, "An algorithmic approach for computing the complement of intuitionistic fuzzy graphs" 2017 13th International Conference on Natural Computation, Fuzzy Systems and Knowledge Discovery (ICNC-FSKD)
- [42] Abdel-Basset, M., Mohamed, M., Smarandache, F., & Chang, V. (2018). Neutrosophic Association Rule Mining Algorithm for Big Data Analysis. *Symmetry*, 10(4), 106.
- [43] Abdel-Basset, M., & Mohamed, M. (2018). The Role of Single Valued Neutrosophic Sets and Rough Sets in Smart City: Imperfect and Incomplete Information Systems. Measurement. [Volume 124](#), August 2018, Pages 47-55
- [44] Abdel-Basset, M., Gunasekaran, M., Mohamed, M., & Smarandache, F. A novel method for solving the fully neutrosophic linear programming problems. *Neural Computing and Applications*, 1-11.
- [45] Abdel-Basset, M., Manogaran, G., Gamal, A., & Smarandache, F. (2018). A hybrid approach of neutrosophic sets and DEMATEL method for developing supplier selection criteria. *Design Automation for Embedded Systems*, 1- 22.



- [46] Abdel-Basset, M., Mohamed, M., & Chang, V. (2018). NMCDA: A framework for evaluating cloud computing services. *Future Generation Computer Systems*, 86, 12-29.
- [47] Abdel-Basset, M., Mohamed, M., Zhou, Y., & Hezam, I. (2017). Multi-criteria group decision making based on neutrosophic analytic hierarchy process. *Journal of Intelligent & Fuzzy Systems*, 33(6), 4055-4066.
- [48] Abdel-Basset, M.; Mohamed, M.; Smarandache, F. An Extension of Neutrosophic AHP–SWOT Analysis for Strategic Planning and Decision-Making. *Symmetry* 2018, 10, 116.
- [49] Abdel-Basset, Mohamed, et al. "A novel group decision-making model based on triangular neutrosophic numbers." *Soft Computing* (2017): 1-15. DOI: <https://doi.org/10.1007/s00500-017-2758-5>
- [50] Abdel-Baset, Mohamed, Ibrahim M. Hezam, and Florentin Smarandache. "Neutrosophic goal programming." *Neutrosophic Sets Syst* 11 (2016): 112-118.
- [51] El-Hefenawy, Nancy, et al. "A review on the applications of neutrosophic sets." *Journal of Computational and Theoretical Nanoscience* 13.1 (2016): 936-944.

Received: August 15, 2018. Accepted: August 31, 2018.



# Plithogenic Set, an Extension of Crisp, Fuzzy, Intuitionistic Fuzzy, and Neutrosophic Sets - Revisited

Florentin Smarandache<sup>1</sup>

<sup>1</sup> Department of Mathematics, University of New Mexico, Gallup, NM 87301, USA. E-mail: smarand@unm.edu

**Abstract.** In this paper, we introduce the plithogenic set (as generalization of crisp, fuzzy, intuitionistic fuzzy, and neutrosophic sets), which is a set whose elements are characterized by many attributes' values. An attribute value  $v$  has a corresponding (fuzzy, intuitionistic fuzzy, or neutrosophic) degree of appurtenance  $d(x, v)$  of the element  $x$ , to the set  $P$ , with respect to some given criteria. In order to obtain a better accuracy for the plithogenic aggregation operators in the plithogenic set, and for a more exact inclusion (partial order), a (fuzzy, intuitionistic fuzzy, or neutrosophic) contradiction (dissimilarity) degree is defined between each attribute value and the dominant (most important) attribute value. The plithogenic intersection and union are linear combinations of the fuzzy operators  $t_{\text{norm}}$  and  $t_{\text{conorm}}$ , while the plithogenic complement, inclusion (inequality), equality are influenced by the attribute values contradiction (dissimilarity) degrees. This article offers some examples and applications of these new concepts in our everyday life.

**Keywords:** Plithogeny; Plithogenic Set; Neutrosophic Set; Plithogenic Operators.

## 1 Informal Definition of Plithogenic Set

Plithogeny is the genesis or origination, creation, formation, development, and evolution of *new entities* from dynamics and organic fusions of contradictory and/or neutrals and/or non-contradictory *multiple old entities*.

While plithogenic means what is pertaining to plithogeny.

A plithogenic set  $P$  is a set whose elements are characterized by one or more attributes, and each attribute may have many values. Each attribute's value  $v$  has a corresponding degree of appurtenance  $d(x, v)$  of the element  $x$ , to the set  $P$ , with respect to some given criteria.

In order to obtain a better accuracy for the plithogenic aggregation operators, a contradiction (dissimilarity) degree is defined between each attribute value and the dominant (most important) attribute value.

{However, there are cases when such dominant attribute value may not be taking into consideration or may not exist [therefore it is considered zero by default], or there may be many dominant attribute values. In such cases, either the contradiction degree function is suppressed, or another relationship function between attribute values should be established.}

The plithogenic aggregation operators (intersection, union, complement, inclusion, equality) are based on contradiction degrees between attributes' values, and the first two are linear combinations of the fuzzy operators'  $t_{\text{norm}}$  and  $t_{\text{conorm}}$ .

Plithogenic set is a generalization of the crisp set, fuzzy set, intuitionistic fuzzy set, and neutrosophic set, since these four types of sets are characterized by a single attribute value (appurtenance): which has one value (membership) – for the crisp set and fuzzy set, two values (membership, and nonmembership) – for intuitionistic fuzzy set, or three values (membership, nonmembership, and indeterminacy) – for neutrosophic set.

## 2 Formal Definition of Single (Uni-Dimensional) Attribute Plithogenic Set

Let  $U$  be a universe of discourse, and  $P$  a non-empty set of elements,  $P \subseteq U$ .

### 2.1 Attribute Value Spectrum

Let  $\mathcal{A}$  be a non-empty set of uni-dimensional attributes  $\mathcal{A} = \{\alpha_1, \alpha_2, \dots, \alpha_m\}$ ,  $m \geq 1$ ; and  $\alpha \in \mathcal{A}$  be a given attribute whose spectrum of all possible values (or states) is the non-empty set  $S$ , where  $S$  can be a finite discrete set,  $S = \{s_1, s_2, \dots, s_l\}$ ,  $1 \leq l < \infty$ , or infinitely countable set  $S = \{s_1, s_2, \dots, s_\infty\}$ , or infinitely uncountable (continuum) set  $S = ]a, b[$ ,  $a < b$ , where  $]... [$  is any open, semi-open, or closed interval from the set of real numbers or from other general set.

## 2.2 Attribute Value Range

Let  $V$  be a non-empty subset of  $S$ , where  $V$  is the *range of all attribute's values* needed by the experts for their application. Each element  $x \in P$  is characterized by all attribute's values in  $V = \{v_1, v_2, \dots, v_n\}$ , for  $n \geq 1$ .

## 2.3 Dominant Attribute Value

Into the attribute's value set  $V$ , in general, there is a dominant attribute value, which is determined by the experts upon their application. Dominant attribute value means the most important attribute value that the experts are interested in.

{However, there are cases when such dominant attribute value may not be taking into consideration or not exist, or there may be many dominant (important) attribute values - when different approach should be employed.}

## 2.4 Attribute Value Appurtenance Degree Function

Each attributes value  $v \in V$  has a corresponding degree of appurtenance  $d(x, v)$  of the element  $x$ , to the set  $P$ , with respect to some given criteria.

The degree of appurtenance may be: a fuzzy degree of appurtenance, or intuitionistic fuzzy degree of appurtenance, or neutrosophic degree of appurtenance to the plithogenic set.

Therefore, the attribute value appurtenance degree function is:

$$\forall x \in P, d: P \times V \rightarrow \mathcal{P}([0, 1]^z), \quad (1)$$

so  $d(x, v)$  is a subset of  $[0, 1]^z$ , and  $\mathcal{A}[0, 1]^z$  is the power set of the  $[0, 1]^z$ , where  $z = 1$  (for fuzzy degree of appurtenance),  $z = 2$  (for intuitionistic fuzzy degree of appurtenance), or  $z = 3$  (for neutrosophic degree de appurtenance).

## 2.5 Attribute Value Contradiction (Dissimilarity) Degree Function

Let the cardinal  $|V| \geq 1$ .

Let  $c: V \times V \rightarrow [0, 1]$  be the attribute value contradiction (dissimilarity) degree function (that we introduce now for the first time) between any two attribute values  $v_1$  and  $v_2$ , denoted by

$c(v_1, v_2)$ , and satisfying the following axioms:

$c(v_1, v_1) = 0$ , the contradiction degree between the same attribute values is zero;

$c(v_1, v_2) = c(v_2, v_1)$ , commutativity.

For simplicity, we use a fuzzy attribute value contradiction degree function ( $c$  as above, that we may denote by  $c_F$  in order to distinguish it from the next two), but an intuitionistic attribute value contradiction function ( $c_{IF}: V \times V \rightarrow [0, 1]^2$ ), or more general a neutrosophic attribute value contradiction function ( $c_N: V \times V \rightarrow [0, 1]^3$ ) may be utilized increasing the complexity of calculation but the accuracy as well.

We mostly compute the contradiction degree between *uni-dimensional attribute values*. For *multi-dimensional attribute values* we split them into corresponding uni-dimensional attribute values.

The attribute value contradiction degree function helps the plithogenic aggregation operators, and the plithogenic inclusion (partial order) relationship to obtain a more accurate result.

The attribute value contradiction degree function is designed in each field where plithogenic set is used in accordance with the application to solve. If it is ignored, the aggregations still work, but the result may lose accuracy.

Several examples will be provided into this paper.

Then  $(P, a, V, d, c)$  is called a plithogenic set:

- where " $P$ " is a set, " $a$ " is a (multi-dimensional in general) attribute, " $V$ " is the range of the attribute's values, " $d$ " is the degree of appurtenance of each element  $x$ 's attribute value to the set  $P$  with respect to some given criteria ( $x \in P$ ), and " $d$ " stands for " $d_F$ " or " $d_{IF}$ " or " $d_N$ ", when dealing with fuzzy degree of appurtenance, intuitionistic fuzzy degree of appurtenance, or neutrosophic degree of appurtenance respectively of an element  $x$  to the plithogenic set  $P$ ;

- and " $c$ " stands for " $c_F$ " or " $c_{IF}$ " or " $c_N$ ", when dealing with fuzzy degree of contradiction, intuitionistic fuzzy degree of contradiction, or neutrosophic degree of contradiction between attribute values respectively.

The functions  $d(\cdot, \cdot)$  and  $c(\cdot, \cdot)$  are defined in accordance with the applications the experts need to solve.

One uses the notation:  $x(d(x, V))$ , where  $d(x, V) = \{d(x, v), \text{ for all } v \in V\}, \forall x \in P$ .

## 2.6 About the Plithogenic Aggregation Set Operators

The attribute value contradiction degree is calculated between each attribute value with respect to the dominant attribute value (denoted  $v_D$ ) in special, and with respect to other attribute values as well.

The attribute value contradiction degree function  $c$  between the attribute's values is used into the definition of plithogenic aggregation operators {*Intersection (AND)*, *Union (OR)*, *Implication ( $\Rightarrow$ )*, *Equivalence ( $\Leftrightarrow$ )*, *Inclusion Relationship (Partial Order, or Partial Inequality)*, and other plithogenic aggregation operators that combine two or more attribute value degrees - that  $t_{norm}$  and  $t_{conorm}$  act upon}.

Most of the plithogenic aggregation operators are linear combinations of the fuzzy  $t_{norm}$  (denoted  $\Lambda_F$ ), and fuzzy  $t_{conorm}$  (denoted  $\vee_F$ ), but non-linear combinations may as well be constructed.

If one applies the  $t_{norm}$  on dominant attribute value denoted by  $v_D$ , and the contradiction between  $v_D$  and  $v_2$  is  $c(v_D, v_2)$ , then onto attribute value  $v_2$  one applies:

$$[1 - c(v_D, v_2)] \cdot t_{norm}(v_D, v_2) + c(v_D, v_2) \cdot t_{conorm}(v_D, v_2), \quad (2)$$

Or, by using symbols:

$$[1 - c(v_D, v_2)] \cdot (v_D \Lambda_F v_2) + c(v_D, v_2) \cdot (v_D \vee_F v_2). \quad (3)$$

Similarly, if one applies the  $t_{conorm}$  on dominant attribute value denoted by  $v_D$ , and the contradiction between  $v_D$  and  $v_2$  is  $c(v_D, v_2)$ , then onto attribute value  $v_2$  one applies:

$$[1 - c(v_D, v_2)] \cdot t_{conorm}(v_D, v_2) + c(v_D, v_2) \cdot t_{norm}(v_D, v_2), \quad (4)$$

Or, by using symbols:

$$[1 - c(v_D, v_2)] \cdot (v_D \vee_F v_2) + c(v_D, v_2) \cdot (v_D \Lambda_F v_2). \quad (5)$$

## 3 Plithogenic Set as Generalization of other Sets

Plithogenic set is a generalization of the crisp set, fuzzy set, intuitionistic fuzzy set, and neutrosophic set, since these four types of sets are characterized by a single attribute (*appurtenance*): which has one value (membership) – for the crisp set and for fuzzy set, two values (membership, and nonmembership) – for intuitionistic fuzzy set, or three values (membership, nonmembership, and indeterminacy) – for neutrosophic set.

For examples:

Let  $U$  be a universe of discourse, and a non-empty set  $P \subseteq U$ . Let  $x \in P$  be a generic element.

### 3.1 Crisp (Classical) Set (CCS)

The attribute is  $\alpha = \text{"appurtenance"}$ ;

the set of attribute values  $V = \{\text{membership, nonmembership}\}$ , with cardinal  $|V| = 2$ ;

the dominant attribute value = membership;

the attribute value appurtenance degree function:

$$d: P \times V \rightarrow \{0, 1\}, \quad (6)$$

$$d(x, \text{membership}) = 1, \quad d(x, \text{nonmembership}) = 0,$$

and the attribute value contradiction degree function:

$$c: V \times V \rightarrow \{0, 1\}, \quad (7)$$

$$c(\text{membership, membership}) = c(\text{nonmembership, nonmembership}) = 0,$$

$$c(\text{membership, nonmembership}) = 1.$$

#### 3.1.1 Crisp (Classical) Intersection

$$a \wedge b \in \{0, 1\} \quad (8)$$

#### 3.1.2 Crisp (Classical) Union

$$a \vee b \in \{0, 1\} \quad (9)$$

#### 3.1.3 Crisp (Classical) Complement (Negation)

$$\neg a \in \{0, 1\}. \quad (10)$$

### 3.2 Single-Valued Fuzzy Set (SVFS)

The attribute is  $\alpha = \text{"appurtenance"}$ ;  
 the set of attribute values  $V = \{\text{membership}\}$ , whose cardinal  $|V| = 1$ ;  
 the dominant attribute value = membership;  
 the appurtenance attribute value degree function:

$$d: P \times V \rightarrow [0, 1], \quad (11)$$

with  $d(x, \text{membership}) \in [0, 1]$ ;  
 and the attribute value contradiction degree function:

$$c: V \times V \rightarrow [0, 1], \quad (12)$$

$$c(\text{membership}, \text{membership}) = 0.$$

#### 3.2.1 Fuzzy Intersection

$$a \wedge_F b \in [0, 1] \quad (13)$$

#### 3.2.2 Fuzzy Union

$$a \vee_F b \in [0, 1] \quad (14)$$

#### 3.2.3 Fuzzy Complement (Negation)

$$\neg_F a = 1 - a \in [0, 1]. \quad (15)$$

### 3.3 Single-Valued Intuitionistic Fuzzy Set (SVIFS)

The attribute is  $\alpha = \text{"appurtenance"}$ ;  
 the set of attribute values  $V = \{\text{membership}, \text{nonmembership}\}$ , whose cardinal  $|V| = 2$ ;  
 the dominant attribute value = membership;  
 the appurtenance attribute value degree function:

$$d: P \times V \rightarrow [0, 1], \quad (16)$$

$d(x, \text{membership}) \in [0, 1]$ ,  $d(x, \text{nonmembership}) \in [0, 1]$ ,  
 with  $d(x, \text{membership}) + d(x, \text{nonmembership}) \leq 1$ ,  
 and the attribute value contradiction degree function:

$$c: V \times V \rightarrow [0, 1], \quad (17)$$

$$c(\text{membership}, \text{membership}) = c(\text{nonmembership}, \text{nonmembership}) = 0,$$

$$c(\text{membership}, \text{nonmembership}) = 1,$$

which means that for SVIFS aggregation operators' intersection (AND) and union (OR), if one applies the  $t_{norm}$  on membership degree, then one has to apply the  $t_{conorm}$  on nonmembership degree – and reciprocally.

Therefore:

#### 3.3.1 Intuitionistic Fuzzy Intersection

$$(a_1, a_2) \wedge_{IFS} (b_1, b_2) = (a_1 \wedge_F b_1, a_2 \vee_F b_2) \quad (18)$$

#### 3.3.2 Intuitionistic Fuzzy Union

$$(a_1, a_2) \vee_{IFS} (b_1, b_2) = (a_1 \vee_F b_1, a_2 \wedge_F b_2), \quad (19)$$

and

#### 3.3.3 Intuitionistic Fuzzy Complement (Negation)

$$\neg_{IFS} (a_1, a_2) = (a_2, a_1). \quad (20)$$

where  $\wedge_F$  and  $\vee_F$  are the fuzzy  $t_{norm}$  and fuzzy  $t_{conorm}$  respectively.

#### 3.3.4 Intuitionistic Fuzzy Inclusions (Partial Orders)

*Simple Intuitionistic Fuzzy Inclusion (the most used by the intuitionistic fuzzy community):*

$$(a_1, a_2) \leq_{IFS} (b_1, b_2) \quad (21)$$

iff  $a_1 \leq b_1$  and  $a_2 \geq b_2$ .

*Plithogenic (Complete) Intuitionistic Fuzzy Inclusion (that we now introduce for the first time):*

$$(a_1, a_2) \leq_P (b_1, b_2) \quad (22)$$

iff  $a_1 \leq (1 - c_v) \cdot b_1, a_2 \geq (1 - c_v) \cdot b_2$ ,

where  $c_v \in [0, 0.5]$  is the contradiction degree between the attribute dominant value and the attribute value  $v$  { the last one whose degree of appurtenance with respect to Expert A is  $(a_1, a_2)$ , while with respect to Expert B is  $(b_1, b_2)$  }. If  $c_v$  does not exist, we take it by default as equal to zero.

### 3.4 Single-Valued Neutrosophic Set (SVNS)

The attribute is  $\alpha = \text{"appurtenance"}$ ;

the set of attribute values  $V = \{\text{membership, indeterminacy, nonmembership}\}$ , whose cardinal  $|V| = 3$ ;

the dominant attribute value = membership;

the attribute value appurtenance degree function:

$$d: P \times V \rightarrow [0, 1], \quad (23)$$

$$d(x, \text{membership}) \in [0, 1], d(x, \text{indeterminacy}) \in [0, 1],$$

$$d(x, \text{nonmembership}) \in [0, 1],$$

$$\text{with } 0 \leq d(x, \text{membership}) + d(x, \text{indeterminacy}) + d(x, \text{nonmembership}) \leq 3;$$

and the attribute value contradiction degree function:

$$c: V \times V \rightarrow [0, 1], \quad (24)$$

$$c(\text{membership, membership}) = c(\text{indeterminacy, indeterminacy}) =$$

$$c(\text{nonmembership, nonmembership}) = 0,$$

$$c(\text{membership, nonmembership}) = 1,$$

$$c(\text{membership, indeterminacy}) = c(\text{nonmembership, indeterminacy}) = 0.5,$$

which means that for the SVNS aggregation operators (Intersection, Union, Complement etc.), if one applies the  $t_{norm}$  on membership, then one has to apply the  $t_{conorm}$  on nonmembership {and reciprocally}, while on indeterminacy one applies the average of  $t_{norm}$  and  $t_{conorm}$ , as follows:

#### 3.4.1 Neutrosophic Intersection

*Simple Neutrosophic Intersection (the most used by the neutrosophic community):*

$$(a_1, a_2, a_3) \wedge_{NS} (b_1, b_2, b_3) = (a_1 \wedge_F b_1, a_2 \vee_F b_2, a_3 \vee_F b_3) \quad (25)$$

*Plithogenic Neutrosophic Intersection:*

$$(a_1, a_2, a_3) \wedge_P (b_1, b_2, b_3) = \left( a_1 \wedge_F b_1, \frac{1}{2} [(a_2 \wedge_F b_2) + (a_2 \vee_F b_2)], a_3 \vee_F b_3 \right) \quad (26)$$

#### 3.4.2 Neutrosophic Union

*Simple Neutrosophic Union (the most used by the neutrosophic community):*

$$(a_1, a_2, a_3) \vee_{NS} (b_1, b_2, b_3) = (a_1 \vee_F b_1, a_2 \wedge_F b_2, a_3 \wedge_F b_3) \quad (27)$$

*Plithogenic Neutrosophic Union:*

$$(a_1, a_2, a_3) \vee_P (b_1, b_2, b_3) = \left( a_1 \vee_F b_1, \frac{1}{2} [(a_2 \wedge_F b_2) + (a_2 \vee_F b_2)], a_3 \wedge_F b_3 \right). \quad (28)$$

In other way, with respect to what one applies on the membership, one applies the opposite on non-membership, while on indeterminacy one applies the average between them.

#### 3.4.3 Neutrosophic Complement (Negation)

$$\neg_{NS} (a_1, a_2, a_3) = (a_3, a_2, a_1). \quad (29)$$

### 3.4.4 Neutrosophic Inclusions (Partial-Orders)

*Simple Neutrosophic Inclusion (the most used by the neutrosophic community):*

$$(a_1, a_2, a_3) \leq_{NS} (b_1, b_2, b_3) \quad (30)$$

iff  $a_1 \leq b_1$  and  $a_2 \geq b_2, a_3 \geq b_3$ .

*Plithogenic Neutrosophic Inclusion (defined now for the first time):*

Since the degrees of contradiction are

$$c(a_1, a_2) = c(a_2, a_3) = c(b_1, b_2) = c(b_2, b_3) = 0.5, \quad (31)$$

one applies:  $a_2 \geq [1 - c(a_1, a_2)]b_2$  or  $a_2 \geq (1 - 0.5)b_2$  or  $a_2 \geq 0.5 \cdot b_2$   
while

$$c(a_1, a_3) = c(b_1, b_3) = 1 \quad (32)$$

{having  $a_1 \leq b_1$  one does the opposite for  $a_3 \geq b_3$ },  
whence

$$(a_1, a_2, a_3) \leq_P (b_1, b_2, b_3) \quad (33)$$

iff  $a_1 \leq b_1$  and  $a_2 \geq 0.5 \cdot b_2, a_3 \geq b_3$ .

## 4 Classifications of the Plithogenic Set

### 4.1 First Classification

#### 4.1.1 Refined Plithogenic Set

If at least one of the attribute's values  $v_k \in V$  is split (refined) into two or more attribute sub-values:  $v_{k1}, v_{k2}, \dots \in V$ , with the attribute sub-value appurtenance degree function:  $d(x, v_{ki}) \in P([0, 1])$ , for  $i = 1, 2, \dots$ , then  $(P_r, \alpha, V, d, c)$  is called a *Refined Plithogenic Set*, where "r" stands for "refined".

#### 4.1.2 Plithogenic Overset / Underset / Offset

If for at least one of the attribute's values  $v_k \in V$ , of at least one element  $x \in P$ , has the attribute value appurtenance degree function  $d(x, v_k)$  exceeding 1, then  $(P_o, \alpha, V, d, c)$  is called a *Plithogenic Overset*, where "o" stands for "overset"; but if  $d(x, v_k)$  is below 0, then  $(P_u, \alpha, V, d, c)$  is called a *Plithogenic Underset*, where "u" stands for "underset"; while if  $d(x, v_k)$  exceeds 1, and  $d(y, s_j)$  is below 0 for the attribute values  $v_k, v_j \in V$  that may be the same or different attribute values corresponding to the same element or to two different elements  $x, y \in P$ , then  $(P_{off}, \alpha, V, d, c)$  is called a *Plithogenic Offset*, where "off" stands for "offset" (or plithogenic set that is both overset and underset).

#### 4.1.3 Plithogenic Multiset

A plithogenic set  $P$  that has at least an element  $x \in P$ , which repeats into the set  $P$  with the same plithogenic components

$$x(a_1, a_2, \dots, a_m), x(a_1, a_2, \dots, a_m) \quad (34)$$

or with different plithogenic components

$$x(a_1, a_2, \dots, a_m), x(b_1, b_2, \dots, b_m), \quad (35)$$

then  $(P_m, \alpha, V, d, c)$  is called a *Plithogenic Multiset*, where "m" stands for "multiset".

#### 4.1.4 Plithogenic Bipolar Set

If  $\forall x \in P, d: P \times V \rightarrow \mathcal{F}([-1, 0]) \times \mathcal{F}([0, 1])$ , then  $(P_b, \alpha, V, d, c)$  is called a *Plithogenic Bipolar Set*, since  $d(x, v)$ , for  $v \in V$ , associates an appurtenance negative degree (as a subset of  $[-1, 0]$ ) and a positive degree (as a subset of  $[0, 1]$ ) to the value  $v$ ; where  $z = 1$  for fuzzy degree,  $z = 2$  for intuitionistic fuzzy degree, and  $z = 3$  for neutrosophic fuzzy degree.

#### 4.1.5-6 Plithogenic Tripolar Set & Plithogenic Multipolar Set

Similar definitions for *Plithogenic Tripolar Set* and *Plithogenic Multipolar Set* (extension from *Neutrosophic Tripolar Set* and respectively *Neutrosophic Multipolar Set* {[4], 123-125}).

#### 4.1.7 Plithogenic Complex Set

If, for any  $x \in P$ ,  $d: P \times V \rightarrow (\mathcal{A}[0, 1]) \times \mathcal{A}[0, 1]^2$ , and for any  $v \in V$ ,  $d(x, v)$  is a complex value, i.e.  $d(x, v) = M_1 \cdot e^{jM_2}$ , where  $M_1 \subseteq [0, 1]$  is called *amplitude*, and  $M_2 \subseteq [0, 1]$  is called *phase*, and the *appurtenance degree* may be fuzzy ( $z = 1$ ), intuitionistic fuzzy ( $z = 2$ ), or neutrosophic ( $z = 3$ ), then  $(P_{\text{com}}, \alpha, V, d, c)$  is called a *Plithogenic Complex Set*.

### 4.2 Second Classification

Upon the values of the appurtenance degree function, one has:

#### 4.2.1 Single-Valued Plithogenic Fuzzy Set

If

$$\forall x \in P, d: P \times V \rightarrow [0, 1], \quad (36)$$

and  $\forall v \in V$ ,  $d(x, v)$  is a single number in  $[0, 1]$ .

#### 4.2.2 Hesitant Plithogenic Fuzzy Set

If

$$\forall x \in P, d: P \times V \rightarrow \mathcal{F}([0, 1]), \quad (37)$$

and  $\forall v \in V$ ,  $d(x, v)$  is a discrete finite set of the form  $\{n_1, n_2, \dots, n_p\}$ , where  $1 \leq p < \infty$ , included in  $[0, 1]$ .

#### 4.2.3 Interval-Valued Plithogenic Fuzzy Set

If

$$\forall x \in P, d: P \times V \rightarrow \mathcal{I}([0, 1]), \quad (38)$$

and  $\forall v \in V$ ,  $d(x, v)$  is an (open, semi-open, closed) interval included in  $[0, 1]$ .

## 5 Applications and Examples

### 5.1 Applications of Uni-Dimensional Attribute Plithogenic Single-Valued Fuzzy Set

Let  $U$  be a universe of discourse, and a non-empty plithogenic set  $P \subseteq U$ . Let  $x \in P$  be a generic element. For simplicity, we consider the uni-dimensional attribute and the single-valued fuzzy degree function.

#### 5.1.1 Small Discrete-Set of Attribute-Values

If the *attribute* is “color”, and we consider only a discrete *set of attribute values*  $V$ , formed by the following six pure colors:

$$V = \{\text{violet, blue, green, yellow, orange, red}\},$$

the *attribute value appurtenance degree function*:

$$d: P \times V \rightarrow [0, 1], \quad (39)$$

$$\begin{aligned} d(x, \text{violet}) &= v \in [0, 1], d(x, \text{blue}) = b \in [0, 1], d(x, \text{green}) = g \in [0, 1], \\ d(x, \text{yellow}) &= y \in [0, 1], d(x, \text{orange}) = o \in [0, 1], d(x, \text{red}) = r \in [0, 1], \end{aligned}$$

then one has:  $x(v, b, g, y, o, r)$ , where  $v, b, g, y, o, r$  are fuzzy degrees of violet, blue, green, yellow, orange, and red, respectively, of the object  $x$  with respect to the set of objects  $P$ , where  $v, b, g, y, o, r \in [0, 1]$ .

The cardinal of the set of attribute values  $V$  is 6.

The other colors are blends of these pure colors.

#### 5.1.2 Large Discrete-Set of Attribute-Values

If the *attribute* is still “color” and we choose a more refined representation of the color values as:

$$x\{d_{390}, d_{391}, \dots, d_{699}, d_{700}\},$$

measured in nanometers, then we have a discrete finite set of attribute values, whose cardinal is:  $700 - 390 + 1 = 311$ , where for each  $j \in V = \{390, 391, \dots, 699, 700\}$ ,  $d_j$  represents the degree to which the object  $x$ 's color, with respect to the set of objects  $P$ , is of “ $j$ ” nanometers per wavelength, with  $d_i \in [0, 1]$ . A nanometer (nm) is a billionth part of a meter.



5.1.3 Infinitely-Uncountable-Set of Attribute-Values

But if the *attribute* is again “color”, then one may choose a continuous representation:

$$x(d([390, 700])),$$

having  $V = [390, 700]$  a closed real interval, hence an infinitely uncountable (continuum) set of attribute values. The cardinal of the  $V$  is  $\infty$ .

For each  $j \in [390, 700]$ ,  $d_j$  represents the degree to which the object  $x$ 's color, with respect to the set of objects  $P$ , is of “ $j$ ” nanometers per wavelength, with  $d_i \in [0, 1]$ . And  $d([390, 700]) = \{d_j, j \in [390, 700]\}$ .

The light, ranging from 390 (violet color) to 700 (red color) nanometers per wavelengths is visible to the eye of the human. The cardinal of the set of attribute values  $V$  is continuum infinity.

5.2 Example of Uni-Attribute (of 4-Attribute-Values) Plithogenic Single-Valued Fuzzy Set Complement (Negation)

Let’s consider that the attribute “size” that has the following values: *small* (the dominant one), *medium*, *big*, *very big*.

Degrees of contradiction	0	0.50	0.75	1
Attribute values	small	medium	big	very big
Degrees of appurtenance	0.8	0.1	0.3	0.2

Table 1.

5.3 Example of Refinement and Negation of a Uni-Attribute (of 4-Attribute-Values) Plithogenic Single-Valued Fuzzy Set

As a refinement of the above table, let’s add the attribute “bigger” as in the below table.

The opposite (negation) of the attribute value “big”, which is 75% in contradiction with “small”, will be an attribute value which is  $1 - 0.75 = 0.25 = 25\%$  in contradiction with “small”, so it will be equal to  $\frac{1}{2}$  [“small” + “medium”]. Let’s call it “less medium”, whose degree of appurtenance is  $1 - 0.3 = 0.7$ .

If the attribute “size” has other values, small being dominant value:

Degrees of contradiction	0	0.14	0.25	0.50	0.75	0.86	1
Attribute values	small	above small (anti-bigger)	less medium (anti-big)	medium	big	bigger	very big
Degrees of appurtenance	0.8	0.6	0.7	0.1	0.3	0.4	0.2

Table 2.

The opposite (negation) of “bigger” is  $1 - 0.86 = 0.14 = 14\%$  in contradiction degree with the dominant attribute value (“small”), so it is in between “small” and “medium”, we may say it is included into the attribute-value interval [small, medium], much closer to “small” than to “medium”. Let’s call it “above small”, whose degree of appurtenance is  $1 - 0.4 = 0.6$ .

5.4 Example of Multi-Attribute (of 24 Attribute-Values) Plithogenic Fuzzy Set Intersection, Union, and Complement

Let  $P$  be a plithogenic set, representing the students from a college. Let  $x \in P$  be a generic student that is characterized by three attributes:

- altitude, whose values are {tall, short}  $\stackrel{\text{def}}{=} \{a_1, a_2\}$ ;
- weight, whose values are {obese, fat, medium, thin}  $\stackrel{\text{def}}{=} \{w_1, w_2, w_3, w_4\}$ ;
- hair color, whose values are {blond, reddish, brown}  $\stackrel{\text{def}}{=} \{h_1, h_2, h_3\}$ .

The multi-attribute of dimension 3 is

$$V_3 = \{(a_i, w_j, h_k), \text{ for all } 1 \leq i \leq 2, 1 \leq j \leq 4, 1 \leq k \leq 3\}.$$

The cardinal of  $V_3$  is  $|V_3| = 2 \times 4 \times 3 = 24$ .

The uni-dimensional attribute contradiction degrees are:

$$\begin{aligned} c(a_1, a_2) &= 1; \\ c(w_1, w_2) &= \frac{1}{3}, c(w_1, w_3) = \frac{2}{3}, c(w_1, w_4) = 1; \\ c(h_1, h_2) &= 0.5, c(h_1, h_3) = 1. \end{aligned}$$

Dominant attribute values are:  $a_1, w_1$ , and  $h_1$  respectively for each corresponding uni-dimensional attribute. Let's use the fuzzy  $t_{norm} = a \wedge_F b = ab$ , and fuzzy  $t_{conorm} = a \vee_F b = a + b - ab$ .

### 5.4.1 Tri-Dimensional Plithogenic Single-Valued Fuzzy Set Intersection and Union

Let

$$x_A = \left\{ \begin{array}{l} d_A(x, a_i, w_j, h_k), \\ \text{for all } 1 \leq i \leq 2, 1 \leq j \leq 4, 1 \leq k \leq 3 \end{array} \right\} \tag{40}$$

and

$$x_B = \left\{ \begin{array}{l} d_B(x, a_i, w_j, h_k), \\ \text{for all } 1 \leq i \leq 2, 1 \leq j \leq 4, 1 \leq k \leq 3 \end{array} \right\}. \tag{41}$$

Then:

$$x_A(a_i, w_j, h_k) \wedge_P x_B(a_i, w_j, h_k) = \left\{ \begin{array}{l} (1 - c(a_D, a_i)) \cdot [d_A(x, a_D) \wedge_F d_B(x, a_i)] \\ + c(a_D, a_i) \cdot [d_A(x, a_D) \vee_F d_B(x, a_i)], 1 \leq i \leq 2; \\ (1 - c(w_D, w_j)) \cdot [d_A(x, w_D) \wedge_F d_B(x, w_j)] \\ + c(w_D, w_j) \cdot [d_A(x, w_D) \vee_F d_B(x, w_j)], 1 \leq j \leq 4; \\ (1 - c(h_D, h_k)) \cdot [d_A(x, h_D) \wedge_F d_B(x, h_k)] \\ + c(h_D, h_k) \cdot [d_A(x, h_D) \vee_F d_B(x, h_k)], 1 \leq k \leq 3. \end{array} \right\} \tag{42}$$

and

$$x_A(a_i, w_j, h_k) \vee_P x_B(a_i, w_j, h_k) = \left\{ \begin{array}{l} (1 - c(a_D, a_i)) \cdot [d_A(x, a_D) \vee_F d_B(x, a_i)] \\ + c(a_D, a_i) \cdot [d_A(x, a_D) \wedge_F d_B(x, a_i)], 1 \leq i \leq 2; \\ (1 - c(w_D, w_j)) \cdot [d_A(x, w_D) \vee_F d_B(x, w_j)] \\ + c(w_D, w_j) \cdot [d_A(x, w_D) \wedge_F d_B(x, w_j)], 1 \leq j \leq 4; \\ (1 - c(h_D, h_k)) \cdot [d_A(x, h_D) \vee_F d_B(x, h_k)] \\ + c(h_D, h_k) \cdot [d_A(x, h_D) \wedge_F d_B(x, h_k)], 1 \leq k \leq 3. \end{array} \right\} \tag{43}$$

Let's have

$$x_A(d_A(a_1) = 0.8, d_A(w_2) = 0.6, d_A(h_3) = 0.5)$$

and

$$x_B(d_B(a_1) = 0.4, d_B(w_2) = 0.1, d_B(h_3) = 0.7).$$

We take only one 3-attribute value:  $(a_1, w_2, h_3)$ , for the other 23 3-attribute values it will be analogously.

For  $x_A \wedge_P x_B$  we calculate for each uni-dimensional attribute separately:

$$\begin{aligned} [1 - c(a_D, a_1)] \cdot [0.8 \wedge_F 0.4] + c(a_D, a_1) \cdot [0.8 \vee_F 0.4] &= (1 - 0) \cdot [0.8(0.4)] + 0 \cdot [0.8 \vee_F 0.4] = 0.32; \\ \left[ 1 - c(w_D, w_2) \cdot [0.6 \wedge_F 0.1] + c(w_D, w_2) \cdot [0.6 \vee_F 0.1] \right] &= \left( 1 - \frac{1}{3} \right) [0.6(0.1)] + \frac{1}{3} [0.6 + 0.1 - 0.6(0.1)] \\ &= \frac{2}{3} [0.06] + \frac{1}{3} [0.64] = \frac{0.76}{3} \approx 0.25; \end{aligned}$$

$$[1 - c(h_D, h_3)] \cdot [0.5 \wedge_F 0.7] + c(h_D, h_3) \cdot [0.5 \vee_F 0.7] = [1 - 1] \cdot [0.5(0.7)] + 1 \cdot [0.5 + 0.7 - 0.5(0.7)] = 0 \cdot [0.35] + 0.85 = 0.85.$$

Whence  $x_A \wedge_p x_B(a_1, w_2, h_3) \approx (0.32, 0.25, 0.85)$ .

For  $x_A \vee_p x_B$  we do similarly:

$$[1 - c(a_D, a_1)] \cdot [0.8 \vee_F 0.4] + c(a_D, a_1) \cdot [0.8 \wedge_F 0.4] = (1 - 0) \cdot [0.8 + 0.4 - 0.8(0.4)] + 0 \cdot [0.8(0.4)] = 1 \cdot [0.88] + 0 = 0.88;$$

$$\left[ 1 - c(w_D, w_2) \cdot [0.6 \vee_F 0.1] + c(w_D, w_2) \cdot [0.6 \wedge_F 0.1] \right] = \left( 1 - \frac{1}{3} \right) [0.6 + 0.1 - 0.6(0.1)] + \frac{1}{3} [0.6(0.1)] = \frac{2}{3} [0.64] + \frac{1}{3} [0.06] = \frac{1.34}{3} \approx 0.44;$$

$$[1 - c(h_D, h_3)] \cdot [0.5 \vee_F 0.7] + c(h_D, h_3) \cdot [0.5 \wedge_F 0.7] = [1 - 1] \cdot [0.5 + 0.7 - 0.5(0.7)] + 1 \cdot [0.5(0.7)] = 0 + 0.35 = 0.35.$$

Whence  $x_A \vee_p x_B(a_1, w_2, h_3) \approx (0.88, 0.44, 0.35)$ .

For  $\neg_p x_A(a_1, w_2, h_3) = (d_A(a_2) = 0.8, d_A(w_3) = 0.6, d_A(h_1) = 0.5)$ , since the opposite of  $a_1$  is  $a_2$ , the opposite of  $w_2$  is  $w_3$ , and the opposite of  $h_3$  is  $h_1$ .

### 5.5 Another Example of Multi-Attribute (of 5 Attribute-Values) Plithogenic Fuzzy Set Complement and Refined Attribute-Value Set

The 5-attribute values plithogenic fuzzy complement (negation) of

$$x \begin{pmatrix} 0 & 0.50 & 0.75 & 0.86 & 1 \\ \text{small, medium, big, bigger, very big} \\ 0.8 & 0.1 & 0.3 & 0.4 & 0.2 \end{pmatrix}$$

Is:

$$\begin{aligned} \neg_p x & \begin{pmatrix} 1 - 1 & 1 - 0.86 & 1 - 0.75 & 1 - 0.50 & 1 - 0 \\ \text{anti - very big, anti - bigger, anti - big, anti - medium, anti - small} \\ 0.2 & 0.4 & 0.3 & 0.1 & 0.8 \end{pmatrix} \\ &= \neg_p x \begin{pmatrix} 0 & 0.14 & 0.25 & 0.50 & 1 \\ \text{small, anti - bigger, anti - big, medium, very big} \\ 0.2 & 0.4 & 0.3 & 0.1 & 0.8 \end{pmatrix} \\ &= \neg_p x \begin{pmatrix} 0 & 0.14 & 0.25 & 0.50 & 1 \\ \text{small, above small, below medium, medium, very big} \\ 0.2 & 0.4 & 0.3 & 0.1 & 0.8 \end{pmatrix}. \end{aligned}$$

Therefore, the original attribute-value set

$$V = \{small, medium, big, bigger, very big\}$$

has been partially refined into:

$$RefinedV = \{small, \text{above small}, \text{below medium}, medium, very big\},$$

where  $above\ small, below\ medium \in \{small, medium\}$ .

### 5.6 Application of Bi-Attribute Plithogenic Single-Valued Set

Let  $\mathcal{U}$  be a universe of discourse, and  $P \subset \mathcal{U}$  a plithogenic set.

In a plithogenic set  $P$ , each element (object)  $x \in P$  is characterized by  $m \geq 1$  attributes  $\alpha_1, \alpha_2, \dots, \alpha_m$ , and each attribute  $\alpha_i, 1 \leq i \leq m$ , has  $r_i \geq 1$  values:

$$V_i = \{v_{i1}, v_{i2}, \dots, v_{ir_i}\}.$$

Therefore, the element  $x$  is characterized by  $r = r_1 \times r_2 \times \dots \times r_m$  attributes' values.

For example, if the attributes are "color" and "height", and their values (required by the application the experts want to do) are:

$$Color = \{green, yellow, red\}$$

and

$$Height = \{tall, medium\},$$

then the object  $x \in P$  is characterized by the Cartesian product

$$Color \times Height = \{(green, tall), (green, medium), (yellow, tall), (yellow, medium), (red, tall), (red, medium)\}$$

Let's consider the dominant (i.e. the most important, or reference) value of attribute "color" be "green", and of attribute "height" be "tall".

The attribute value contradiction fuzzy degrees are:

$$c(green, green) = 0,$$

$$c(green, yellow) = \frac{1}{3},$$

$$c(green, red) = \frac{2}{3},$$

$$c(tall, tall) = 0,$$

$$c(tall, medium) = \frac{1}{2}.$$

Suppose we have two experts  $A$  and  $B$ . Further on, we consider (fuzzy, intuitionistic fuzzy, or neutrosophic) degrees of appurtenance of each attribute value to the set  $P$  with respect to experts' criteria.

We consider the single value number fuzzy degrees, for simplicity of the example.

Let  $v_i$  be a uni-attribute value and its degree of contradiction with respect to the dominant uni-attribute value  $v_D$  be  $c(v_D, v_i) \stackrel{\text{def}}{=} c_i$ .

Let  $d_A(x, v_i)$  be the appurtenance degree of the attribute value  $v_i$  of the element  $x$  with respect to the set  $A$ . And similarly for  $d_B(x, v_i)$ . Then, we recall the plithogenic aggregation operators with respect to this attribute value  $v_i$  that will be employed:

### 5.6.1 One-Attribute Value Plithogenic Single-Valued Fuzzy Set Intersection

$$d_A(x, v_i) \wedge_p d_B(x, v_i) = (1 - c_i) \cdot [d_A(x, v_i) \wedge_F d_B(x, v_i)] + c_i \cdot [d_A(x, v_i) \vee_F d_B(x, v_i)] \tag{44}$$

### 5.6.2 One-Attribute Value Plithogenic Single-Valued Fuzzy Set Union

$$d_A(x, v_i) \vee_p d_B(x, v_i) = (1 - c_i) \cdot [d_A(x, v_i) \vee_F d_B(x, v_i)] + c_i \cdot [d_A(x, v_i) \wedge_F d_B(x, v_i)] \tag{45}$$

### 5.6.3 One Attribute Value Plithogenic Single-Valued Fuzzy Set Complement (Negation)

$$\neg_p v_i = anti(v_i) = (1 - c_i) \cdot v_i \tag{46}$$

$$\neg_p d_A(x, (1 - c_i)v_i) = d_A(x, v_i) \tag{47}$$

## 5.7 Single-Valued Fuzzy Set Degrees of Appurtenance

According to Expert A:  $d_A: \{green, yellow, red; tall, medium\} \rightarrow [0, 1]$ .

One has:

$$d_A(green) = 0.6,$$

$$d_A(yellow) = 0.2,$$

$$d_A(red) = 0.7;$$

$$d_A(tall) = 0.8,$$

$$d_A(medium) = 0.5.$$

We summarize as follows:

According to Expert A:

Contradiction Degrees	0	$\frac{1}{3}$	$\frac{2}{3}$	0	$\frac{1}{2}$
Attributes' Values	green	yellow	red	tall	medium
Fuzzy Degrees	0.6	0.2	0.7	0.8	0.5

Table 3.

According to Expert B:

Contradiction Degrees	0	$\frac{1}{3}$	$\frac{2}{3}$	0	$\frac{1}{2}$
Attributes' Values	green	yellow	red	tall	medium
Fuzzy Degrees	0.7	0.4	0.6	0.6	0.4

Table 4.

The element

$$x\{ (green, tall), (green, medium), (yellow, tall), (yellow, medium), (red, tall), (red, medium) \} \in P$$

with respect to the two experts as above is represented as:

$$x_A\{(0.6, 0.8), (0.6, 0.5), (0.2, 0.8), (0.2, 0.5), (0.7, 0.8), (0.7, 0.5)\}$$

and

$$x_B\{(0.7, 0.6), (0.7, 0.4), (0.4, 0.6), (0.4, 0.4), (0.6, 0.6), (0.6, 0.4)\}.$$

In order to find the optimal representation of  $x$ , we need to intersect  $x_A$  and  $x_B$ , each having six duplets. Actually, we separately intersect the corresponding duplets.

In this example, we take the fuzzy  $t_{norm}: a \wedge_F b = ab$  and the fuzzy  $t_{conorm}: a \vee_F b = a + b - ab$ .

### 5.7.1 Application of Uni-Attribute Value Plithogenic Single-Valued Fuzzy Set Intersection

Let's compute  $x_A \wedge_p x_B$ .

$$\begin{matrix} 0 & 0 & 0 & 0 & \{degrees\ of\ contradictions\} \\ (0.6, 0.8) \end{matrix} \wedge_p (0.7, 0.6) = (0.6 \wedge_p 0.7, 0.8 \wedge_p 0.6) = (0.6 \cdot 0.7, 0.8 \cdot 0.6) = (0.42, 0.48),$$

where above each duplet we wrote the degrees of contradictions of each attribute value with respect to their correspondent dominant attribute value. Since they were zero,  $\wedge_p$  coincided with  $\wedge_F$ .

{the first row below  $0 \frac{1}{2}$  and again  $0 \frac{1}{2}$  represents the contradiction degrees}

$$\begin{pmatrix} 0 & \frac{1}{2} \\ 0.6 & 0.5 \end{pmatrix} \wedge_p \begin{pmatrix} 0 & \frac{1}{2} \\ 0.7 & 0.4 \end{pmatrix} = (0.6 \wedge_p 0.7, 0.5 \wedge_p 0.4) = (0.6 \cdot 0.7, (1 - 0.5) \cdot [0.5 \wedge_F 0.4] + 0.5 \cdot [0.5 \vee_F 0.4])$$

$$= (0.42, 0.5[0.2] + 0.5[0.5 + 0.4 - 0.5 \cdot 0.4]) = (0.42, 0.45).$$

$$\begin{pmatrix} \frac{1}{3} & 0 \\ 0.2 & 0.8 \end{pmatrix} \wedge_p \begin{pmatrix} \frac{1}{3} & 0 \\ 0.4 & 0.6 \end{pmatrix} = (0.2 \wedge_p 0.4, 0.8 \wedge_p 0.6) = \left( \left\{ 1 - \frac{1}{3} \right\} \cdot [0.2 \wedge_F 0.4] + \left\{ \frac{1}{3} \right\} \cdot [0.2 \vee_F 0.4], 0.8 \cdot 0.6 \right)$$

$$\approx (0.23, 0.48).$$

$$\begin{pmatrix} \frac{1}{3} & \frac{1}{2} \\ 0.2 & 0.5 \end{pmatrix} \wedge_p \begin{pmatrix} \frac{1}{3} & \frac{1}{2} \\ 0.4 & 0.4 \end{pmatrix} = (0.2 \wedge_p 0.4, 0.5 \wedge_p 0.4)$$

(they were computed above)

$$\approx (0.23, 0.45).$$

$$\begin{pmatrix} \frac{2}{3} & 0 \\ 0.7 & 0.8 \end{pmatrix} \wedge_p \begin{pmatrix} \frac{2}{3} & 0 \\ 0.6 & 0.6 \end{pmatrix} = (0.7 \wedge_p 0.8, 0.8 \wedge_p 0.6) = \left( \left\{ 1 - \frac{2}{3} \right\} \cdot [0.7 \wedge_F 0.6] + \left\{ \frac{2}{3} \right\} \cdot [0.7 \vee_F 0.6], 0.8 \cdot 0.6 \right)$$

(the second component was computed above)

$$= \left( \frac{1}{3}[0.7 \cdot 0.6] + \frac{2}{3}[0.7 + 0.6 - 0.7 \cdot 0.6], 0.48 \right) \approx (0.73, 0.48).$$

And the last duplet:

$$\begin{pmatrix} \frac{2}{3} & \frac{1}{2} \\ 0.7 & 0.5 \end{pmatrix} \wedge_p \begin{pmatrix} \frac{2}{3} & \frac{1}{2} \\ 0.6 & 0.4 \end{pmatrix} = (0.7 \wedge_p 0.6, 0.5 \wedge_p 0.4)$$

$$\approx (0.73, 0.45)$$

(they were computed above).

Finally:

$$x_A \wedge_p x_B \approx \left\{ (0.42, 0.48), (0.42, 0.45), (0.23, 0.48), (0.23, 0.45), (0.73, 0.48), (0.73, 0.45) \right\}$$

or, after the intersection of the experts' opinions  $A \wedge_p B$ , we summarize the result as:

Contradiction Degrees	0	$\frac{1}{3}$	$\frac{2}{3}$	0	$\frac{1}{2}$
Attributes' Values	green	yellow	red	tall	medium
Fuzzy Degrees of Expert A for x	0.6	0.2	0.7	0.8	0.5
Fuzzy Degrees of Expert B for x	0.7	0.4	0.6	0.6	0.4
Fuzzy Degrees of $x_A \wedge_p x_B$	0.42	0.23	0.73	0.48	0.45
Fuzzy Degrees of $x_A \vee_p x_B$	0.88	0.37	0.57	0.92	0.45

Table 5.

### 5.7.2 Application of Uni-Attribute Value Plithogenic Single-Valued Fuzzy Set Union

We separately compute for each single attribute value:

$$d_A^F(x, green) \vee_p d_B^F(x, green) = 0.6 \vee_p 0.7 = (1 - 0) \cdot [0.6 \vee_F 0.7] + 0 \cdot [0.6 \wedge_F 0.7] = 1 \cdot [0.6 + 0.7 - 0.6 \cdot 0.7] + 0 = 0.88.$$

$$d_A^F(x, yellow) \vee_p d_B^F(x, yellow) = 0.2 \vee_p 0.4 = \left(1 - \frac{1}{3}\right) \cdot [0.2 \vee_F 0.4] + \frac{1}{3} \cdot [0.2 \wedge_F 0.4] = \frac{2}{3} \cdot (0.2 + 0.4 - 0.2 \cdot 0.4) + \frac{1}{3} (0.2 \cdot 0.4) \approx 0.37.$$

$$d_A^F(x, red) \vee_p d_B^F(x, red) = 0.7 \vee_p 0.6 = \left\{1 - \frac{2}{3}\right\} \cdot [0.7 \vee_F 0.6] + \frac{2}{3} \cdot [0.7 \wedge_F 0.6] = \frac{1}{3} \cdot (0.7 + 0.6 - 0.7 \cdot 0.6) + \frac{2}{3} (0.7 \cdot 0.6) \approx 0.57.$$

$$d_A^F(x, tall) \vee_p d_B^F(x, tall) = 0.8 \vee_p 0.6 = (1 - 0) \cdot (0.8 + 0.6 - 0.8 \cdot 0.6) + 0 \cdot (0.8 \cdot 0.6) = 0.92.$$

$$d_A^F(x, medium) \vee_p d_B^F(x, medium) = 0.5 \vee_p 0.4 = \frac{1}{2} (0.5 + 0.4 - 0.5 \cdot 0.4) + \frac{1}{2} \cdot (0.5 \cdot 0.4) = 0.45.$$

### 5.7.3 Properties of Plithogenic Single-Valued Set Operators in Applications

1) When the attribute value contradiction degree with respect to the corresponding dominant attribute value is 0 (zero), one simply use the fuzzy intersection:

$$d_{A \wedge_p B}(x, green) = d_A(x, green) \wedge_F d_B(x, green) = 0.6 \cdot 0.7 = 0.42,$$

and

$$d_{A \wedge_p B}(x, tall) = d_A(x, tall) \wedge_F d_B(x, tall) = 0.8 \cdot 0.6 = 0.48.$$

2) But, if the attribute value contradiction degree with respect to the corresponding dominant attribute value is different from 0 and from 1, the result of the plithogenic intersection is between the results of fuzzy  $t_{norm}$  and fuzzy  $t_{conorm}$ .

Examples:

$$d_A(x, yellow) \wedge_F d_B(x, yellow) = 0.2 \wedge_F 0.4 = 0.2 \cdot 0.4 = 0.08 (t_{norm}),$$

$$d_A(x, yellow) \vee_F d_B(x, yellow) = 0.2 \vee_F 0.4 = 0.2 + 0.4 - 0.2 \cdot 0.4 = 0.52 (t_{conorm});$$

while

$$d_A(x, yellow) \wedge_p d_B(x, yellow) = 0.23 \in [0.08, 0.52]$$

{or  $0.23 \approx 0.2266\dots = (2/3) \times 0.08 + (1/3) \times 0.52$ , i.e. a linear combination of  $t_{norm}$  and  $t_{conorm}$ }.

Similarly:

$$d_A(x, red) \wedge_p d_B(x, red) = 0.7 \wedge_F 0.6 = 0.7 \cdot 0.6 = 0.42 (t_{norm}),$$

$$d_A(x, red) \vee_p d_B(x, red) = 0.7 \vee_F 0.6 = 0.7 + 0.6 - 0.7 \cdot 0.6 = 0.88 (t_{conorm});$$

while

$$d_A(x, red) \wedge_p d_B(x, red) = 0.57 \in [0.42, 0.88]$$

{linear combination of  $t_{norm}$  and  $t_{conorm}$ }.

And

$$d_A(x, medium) \wedge_F d_B(x, medium) = 0.5 \wedge_F 0.4 = 0.5 \cdot 0.4 = 0.20,$$

$$d_A(x, medium) \vee_F d_B(x, medium) = 0.5 \vee_F 0.4 = 0.5 + 0.4 - 0.5 \cdot 0.4 = 0.70,$$

while

$$d_A(x, medium) \wedge_p d_B(x, medium) = 0.45,$$

which is just in the middle (because “medium” contradiction degree is  $\frac{1}{2}$ ) of the interval  $[0.20, 0.70]$ .

## Conclusion & Future Research

As generalization of dialectics and neutrosophy, plithogeny will find more use in blending diverse philosophical, ideological, religious, political and social ideas. After the extension of fuzzy set, intuitionistic fuzzy set, and neutrosophic set to the plithogenic set; the extension of classical logic, fuzzy logic, intuitionistic fuzzy logic and neutrosophic logic to plithogenic logic; and the extension of classical probability, imprecise probability, and neutrosophic probability to plithogenic probability [12] – more applications of the plithogenic set/logic/probability/statistics in various fields should follow. The classes of plithogenic implication operators and their corresponding sets of plithogenic rules are to be constructed in this direction. Also, exploration of non-linear combinations of  $t_{norm}$  and  $t_{conorm}$ , or of other norms and conorms, in constructing of more sophisticated plithogenic set, logic and probabilistic aggregation operators, for a better modeling of real life applications.

## References

- [1] L.A. Zadeh, "Fuzzy sets", Inform. and Control 8 (1965), 338-353.
- [2] K. Atanassov, "Intuitionistic fuzzy sets", Fuzzy Sets and Systems 20 (1986), 87-96.
- [3] K. Atanassov, "Two variants of intuitionistic fuzzy propositional calculus", Preprint IM-MFAIS-5-88, 1988.
- [4] Florentin Smarandache, "Neutrosophic Overset, Neutrosophic Underset, and Neutrosophic Offset. Similarly for Neutrosophic Over-/Under-/Off- Logic, Probability, and Statistics", 168 p., Pons Editions, Brussels, Belgium, 2016;
- [5] Florentin Smarandache, "n-Valued Refined Neutrosophic Logic and Its Applications in Physics", Progress in Physics, 143-146, Vol. 4, 2013; <https://arxiv.org/ftp/arxiv/papers/1407/1407.1041.pdf>
- [6] Florentin Smarandache, "Subtraction and Division of Neutrosophic Numbers", Critical Review, Creighton University, The Society for Mathematics of Uncertainty (SMU), Vol. XIII, 2016, pp. 103-110.
- [7] S. Broumi, S. & F. Smarandache, "Cosine similarity measure of interval neutrosophic sets". Neutrosophic Sets and Systems, 5, 15-20, 2014.
- [8] J. Ye, (2014). "Improved correlation coefficients of single valued neutrosophic sets and interval neutrosophic sets for multiple attribute decision making". Journal of Intelligent & Fuzzy Systems, 27, 2453-2462, 2014.
- [9] F. Smarandache, "Neutrosophy, A New Branch of Philosophy", <Multiple Valued Logic / An International Journal>, USA, ISSN 1023-6627, Vol. 8, No. 3, pp. 297-384, 2002.
- [10] F. Smarandache, "A Unifying Field in Logics: Neutrosophic Logic", <Multiple Valued Logic / An International Journal>, USA, ISSN 1023-6627, Vol. 8, No. 3, pp. 385-438, 2002. The whole issue of this journal is dedicated to Neutrosophy and Neutrosophic Logic.
- [11] F. Smarandache, "Definitions Derived from Neutrosophics", <Multiple Valued Logic / An International Journal>, USA, ISSN 1023-6627, Vol. 8, No. 5-6, pp. 591-604, 2002.
- [12] F. Smarandache, "Plithogeny, Plithogenic Set, Logic, Probability, and Statistics", 141 pages, Pons Editions, Brussels, Belgium, 2017. arXiv.org (Cornell University), Computer Science - Artificial Intelligence, 03Bxx: abstract: <https://arxiv.org/abs/1808.03948>, book: <https://arxiv.org/ftp/arxiv/papers/1808/1808.03948.pdf>, Harvard SAO/NASA ADS: [http://adsabs.harvard.edu/cgi-bin/bib\\_query?arXiv:1808.03948](http://adsabs.harvard.edu/cgi-bin/bib_query?arXiv:1808.03948)
- [13] Florentin Smarandache, "Physical Plithogenic Set", 71st Annual Gaseous Electronics Conference, Session LW1, Oregon Convention Center Room, Portland, Oregon, USA, November 5–9, 2018; <http://meetings.aps.org/Meeting/GEC18/Session/LW1.110>

Received: August 17, 2018. Accepted: September 3, 2018.

Neutrosophic Sets and Systems (NSS) is an academic journal, published quarterly online and on paper, that has been created for publications of advanced studies in neutrosophy, neutrosophic set, neutrosophic logic, neutrosophic probability, neutrosophic statistics etc. and their applications in any field.

All submitted papers should be professional, in good English, containing a brief review of a problem and obtained results.

It is an open access journal distributed under the Creative Commons Attribution License that permits unrestricted use, distribution, and reproduction in any medium, provided the original work is properly cited.

ISSN (print): 2331-6055, ISSN (online): 2331-608X  
Impact Factor: 1.739

NSS has been accepted by SCOPUS. Starting with Vol. 19, 2018, all NSS articles are indexed in Scopus.

NSS is also indexed by Google Scholar, Google Plus, Google Books, EBSCO, Cengage Thompson Gale (USA), Cengage Learning, ProQuest, Amazon Kindle, DOAJ (Sweden), University Grants Commission (UGC) - India, International Society for Research Activity (ISRA), Scientific Index Services (SIS), Academic Research Index (ResearchBib), Index Copernicus (European Union), CNKI (Tongfang Knowledge Network Technology Co., Beijing, China), etc.

Google Dictionary has translated the neologisms "neutrosophy" (1) and "neutrosophic" (2), coined in 1995 for the first time, into about 100 languages.

FOLDOC Dictionary of Computing (1, 2), Webster Dictionary (1, 2), Wordnik (1), Dictionary.com, The Free Dictionary (1), Wiktionary (2), YourDictionary (1, 2), OneLook Dictionary (1, 2), Dictionary / Thesaurus (1), Online Medical Dictionary (1, 2), and Encyclopedia (1, 2) have included these scientific neologisms.

DOI numbers are assigned to all published articles.

Registered by the Library of Congress, Washington DC, United States,  
<https://lccn.loc.gov/2013203857>.

### Editors-in-Chief:

Prof. Florentin Smarandache  
Department of Mathematics and Science  
University of New Mexico  
705 Gurley Avenue  
Gallup, NM 87301, USA  
E -mail: smarand@unm.edu

Dr. Surapati Pramanik, Assistant  
Professor, Department of Mathematics,  
Nandalal Ghosh B.T. College, Panpur,  
Narayanpur, Dist-North 24 Parganas,  
West Bengal, India-743126  
E -mail: sura\_pati@yahoo.co.in

