

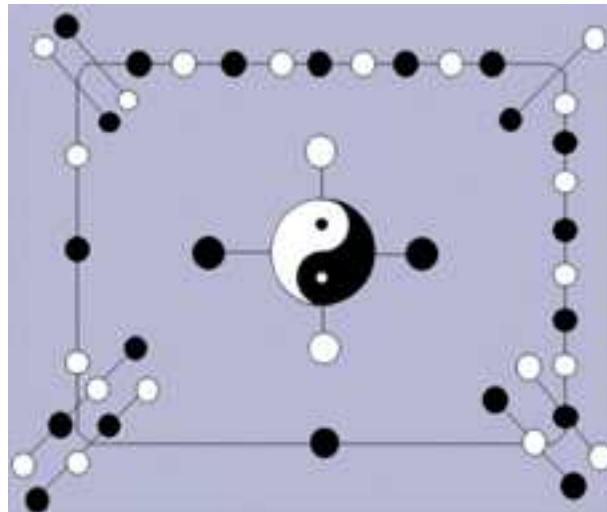

ISSN 1937 - 1055

VOLUME 2, 2008

INTERNATIONAL JOURNAL OF
MATHEMATICAL COMBINATORICS



EDITED BY

THE MADIS OF CHINESE ACADEMY OF SCIENCES

April, 2008

Vol.2, 2008

ISSN 1937-1055

International Journal of
Mathematical Combinatorics

Edited By

The Madis of Chinese Academy of Sciences

April, 2008

Aims and Scope: The **International J.Mathematical Combinatorics** (*ISSN 1937-1055*) is a fully refereed international journal, sponsored by the *MADIS of Chinese Academy of Sciences* and published in USA quarterly comprising 100-150 pages approx. per volume, which publishes original research papers and survey articles in all aspects of Smarandache multi-spaces, Smarandache geometries, mathematical combinatorics, non-euclidean geometry and topology and their applications to other sciences. Topics in detail to be covered are:

Smarandache multi-spaces with applications to other sciences, such as those of algebraic multi-systems, multi-metric spaces, ···, etc.. Smarandache geometries;

Differential Geometry; Geometry on manifolds;

Topological graphs; Algebraic graphs; Random graphs; Combinatorial maps; Graph and map enumeration; Combinatorial designs; Combinatorial enumeration;

Low Dimensional Topology; Differential Topology; Topology of Manifolds;

Geometrical aspects of Mathematical Physics and Relations with Manifold Topology;

Applications of Smarandache multi-spaces to theoretical physics; Applications of Combinatorics to mathematics and theoretical physics;

Mathematical theory on gravitational fields; Mathematical theory on parallel universes;

Other applications of Smarandache multi-space and combinatorics.

Generally, papers on mathematics with its applications not including in above topics are also welcome.

It is also available in **microfilm format** and can be ordered online from:

Books on Demand

ProQuest Information & Learning

300 North Zeeb Road

P.O.Box 1346, Ann Arbor

MI 48106-1346, USA

Tel:1-800-521-0600(Customer Service)

URL: <http://madisl.iss.ac.cn/IJMC.htm/>

Indexing and Reviews: Mathematical Reviews(USA), Zentralblatt fur Mathematik(Germany), Referativnyi Zhurnal (Russia), Mathematika (Russia), Computing Review (USA), Institute for Scientific Information (PA, USA), Library of Congress Subject Headings (USA).

Subscription A subscription can be ordered by a mail or an email directly to the Editor-in-Chief.

Linfan Mao

The Editor-in-Chief of *International Journal of Mathematical Combinatorics*

Chinese Academy of Mathematics and System Science

Beijing, 100080, P.R.China

Email: maolinfan@163.com

Printed in the United States of America

Price: US\$48.00

Editorial Board

Editor-in-Chief

Linfan MAO

Chinese Academy of Mathematics and System
Science, P.R.China
Email: maolinfan@163.com

Editors

S.Bhattacharya

Alaska Pacific University, USA
Email: sbhattacharya@alaskapacific.edu

An Chang

Fuzhou University, P.R.China
Email: anchang@fzh.edu.cn

Junliang Cai

Beijing Normal University, P.R.China
Email: caijunliang@bnu.edu.cn

Yanxun Chang

Beijing Jiaotong University, P.R.China
Email: yxchang@center.njtu.edu.cn

Shaofei Du

Capital Normal University, P.R.China
Email: dushf@mail.cnu.edu.cn

Florentin Popescu

University of Craiova
Craiova, Romania

Xiaodong Hu

Chinese Academy of Mathematics and System
Science, P.R.China
Email: xdhu@amss.ac.cn

Yuanqiu Huang

Hunan Normal University, P.R.China
Email: hyqq@public.cs.hn.cn

H.Iseri

Mansfield University, USA
Email: hiseri@mnsfld.edu

M.Khoshnevisan

School of Accounting and Finance,
Griffith University, Australia

Xueliang Li

Nankai University, P.R.China
Email: lxl@nankai.edu.cn

Han Ren

East China Normal University, P.R.China
Email: hren@math.ecnu.edu.cn

W.B.Vasantha Kandasamy

Indian Institute of Technology, India
Email: vasantha@iitm.ac.in

Mingyao Xu

Peking University, P.R.China
Email: xumy@math.pku.edu.cn

Guiying Yan

Chinese Academy of Mathematics and System
Science, P.R.China
Email: yanguiying@yahoo.com

Y. Zhang

Department of Computer Science
Georgia State University, Atlanta, USA

Nature never deceives us; it is we who deceive ourselves.

Rousseau, a French thinker.

The Characterization of Symmetric Primitive Matrices with Exponent $n - 2$

Junliang Cai

School of Mathematical Sciences and Laboratory of Mathematics and Complex Systems

Beijing Normal University, Beijing, 100875, P.R.China.

Email: caijunliang@bnu.edu.cn

Abstract: In this paper the symmetric primitive matrices of order n with exponent $n - 2$ are completely characterized by applying a combinatorial approach, i.e., mathematical combinatorics ([7]).

Key words: primitive matrix, primitive exponent, graph.

AMS(2000): 05C50.

§1. Introduction

An $n \times n$ nonnegative matrix $\mathbf{A} = (a_{ij})$ is said to be *primitive* if $\mathbf{A}^k > 0$ for some positive integer k . The least such k is called the *exponent* of the matrix \mathbf{A} and is denoted by $\gamma(\mathbf{A})$.

Suppose that $SE_n = \{\gamma(\mathbf{A}) : \mathbf{A} \text{ is a symmetric and primitive } n \times n \text{ matrix}\}$ be the exponent set of $n \times n$ symmetric primitive matrices. In 1986, J.Y.Shao^[1] proved $SE_n = \{1, 2, \dots, 2n - 2\} \setminus S$, where S is the set of all odd numbers among $\{n, n + 1, \dots, 2n - 2\}$ and gave the characterization of the matrix with exponent $2n - 2$. In 1990, B.L.Liu et al^[2] gave the characterization of the matrix with exponent $2n - 4$. In 1991, G.R.Li et al^[3] obtained the characterization with exponent $2n - 6$. In 1995, J.L.Cai et al^[4] derived the complete characterization of symmetric primitive matrices with exponent $2n - 2r (\geq n)$ which is a generalization of the results in [1, 2, 3], where $r = 1, 2, 3$, respectively. In 2003, J.L.Cai et al^[5] derived the complete characterization of symmetric primitive matrices with exponent $n - 1$. However, there are no results regarding the characterization of symmetric primitive matrices of exponent $n - 1$. The purpose of this paper is to go further into the problem and give the complete characterization of symmetric primitive matrices with exponent $n - 2$ by applying a combinatorial approach, i.e., mathematical combinatorics ([7]).

The associated graph of *symmetric matrix* \mathbf{A} , denoted by $G(\mathbf{A})$, is a graph with a vertex set $V(G(\mathbf{A})) = \{1, 2, \dots, n\}$ such that there is an edge from i to j in graph $G(\mathbf{A})$ if and only if $a_{ij} > 0$. Hence $G(\mathbf{A})$ may contain loops if $a_{ii} > 0$ for some i . A graph G is called to be

¹Received February 26, 2008. Accepted March 18, 2008.

²Foundation item: Project 10271017 (2002) supported by NNSFC.

primitive if there exists an integer $k > 0$ such that for all ordered pairs of vertices $i, j \in V(G)$ (not necessarily distinct), there is a walk from i to j with length k . The least such k is called the *exponent* of G , denoted by $\gamma(G)$. Clearly, a symmetric matrix \mathbf{A} is primitive if and only if its associated graph $G(\mathbf{A})$ is primitive. And in this case, we have $\gamma(\mathbf{A}) = \gamma(G(\mathbf{A}))$. By this reason as above, we shall employ graph theory as a major tool and consider $\gamma(G(\mathbf{A}))$ to prove our results.

Terminologies and notations not explained in this paper are referred to the reference [6].

§2. Some Lemmas

In the following, we need the conception of the local exponent, i.e., the exponent from vertex u to vertex v , denoted by $\gamma(u, v)$, is the least integer k such that there exists a walk of length m from u to v for all $m \geq k$. We denote $\gamma(u, u)$ by $\gamma(u)$ for convenience.

Lemma 2.1([1]) *A undirected graph G is primitive if and only if G is connected and has odd cycles.*

Lemma 2.2([1]) *If G is a primitive graph, then*

$$\gamma(G) = \max_{u, v \in V(G)} \gamma(u, v).$$

Lemma 2.3([2]) *Let G be a primitive graph, and let $u, v \in V(G)$. If there are two walks from u to v with lengths k_1 and k_2 , respectively, where $k_1 + k_2 \equiv 1 \pmod{2}$, then*

$$\gamma(u, v) \leq \max\{k_1, k_2\} - 1.$$

Suppose that $P_{\min}(u, v)$ is a shortest path between u and v in G with the length $d_G(u, v) = |P_{\min}(u, v)|$, called the distance between u and v in G . The *diameter* of G is defined as

$$\text{diam}(G) = \max_{u, v \in V(G)} d_G(u, v).$$

Suppose that $P_{\min}(G_1, G_2)$ is a shortest path between subgraphs G_1 and G_2 of G with the length $d_G(G_1, G_2) = |P_{\min}(G_1, G_2)|$, called the distance between G_1 and G_2 in G . It is obvious that

$$d_G(G_1, G_2) = |P_{\min}(G_1, G_2)| = \min\{|P_{\min}(u, v)| \mid u \in V(G_1), v \in V(G_2)\}.$$

Let u and v be two vertices in G , an (u, v) -walk is said to be a *different walk* if the length of the walk and the distance between u and v have different parity. A shortest different walk is said to be a *primitive walk*, denoted by $W_{\text{rim}}(u, v)$ and its length by $b_G(u, v)$ or simply by $b(u, v)$.

Clearly, for any two vertices u and v in G , we have

$$d_G(u, v) < b_G(u, v), \quad d_G(u, v) + b_G(u, v) \equiv 1 \pmod{2}.$$

Lemma 2.4([5]) *Suppose that G is a primitive graph and $u, v \in V(G)$, then we have*

- (a) $\gamma(u, v) \geq d_G(u, v)$;
- (b) $\gamma(u, v) \equiv d_G(u, v) \pmod{2}$;
- (c) $\gamma(G) \geq \text{diam}(G)$, $\gamma(G) \equiv \text{diam}(G) \pmod{2}$.

Lemma 2.5([5]) *Suppose that G is a primitive graph with order n . If there are $u, v \in V(G)$ such that $\gamma(u, v) = \gamma(G) \leq n$, then for any odd cycle C in G we have*

$$|V(P_{\min}(u, v)) \cap V(C)| \leq n - \gamma(G),$$

where $P_{\min}(u, v)$ is the shortest path from u to v in G .

Lemma 2.6 *Suppose that G is a primitive graph, $u, v \in V(G)$, then*

$$\gamma(u, v) = b_G(u, v) - 1.$$

Thus

$$\gamma(G) = \max_{u, v \in V(G)} b_G(u, v) - 1.$$

Proof Considering the definitions of $\gamma(u, v)$ and $b_G(u, v)$, there is no any (u, v) -walk with the length of $b_G(u, v) - 2$. So $\gamma(u, v) \geq b_G(u, v) - 1$.

On the other hand, for any natural number $k \geq b_G(u, v) - 1$, from the shortest path $P_{\min}(u, v)$ we can make a walk of the length k between u and v when $d_G(u, v) - k \equiv 0 \pmod{2}$; from the primitive walk $W_{\text{rim}}(u, v)$ we can make a walk of the length k between u and v when $d_G(u, v) - k \equiv 1 \pmod{2}$. So $\gamma(u, v) \leq b_G(u, v) - 1$.

Thus, we have $\gamma(u, v) = b_G(u, v) - 1$. The last result is true by Lemma 2.2. \square

According to what is mentioned as above, for arbitrary $u, v \in V(G)$, a different walk of two vertices u and v , denoted by $W(u, v)$, must relate to a cycle C of G . In fact, the symmetric difference $P_{\min}(u, v) \Delta W(u, v)$ of $P_{\min}(u, v)$ and $W(u, v)$ must contain an odd cycle. Conversely, any odd cycle C in G can make a different walk $W(u, v)$ between u and v because of the connectivity of G . So we often write $W(u, v) = W(u, v, C)$. It is clear that for any $u, v \in V(G)$ there must be an odd cycle C' in G such that

$$b_G(u, v) = b_G(u, v, C') = |W_{\text{rim}}(u, v, C')|,$$

then from Lemma 2.6 we have $\gamma(u, v) = \gamma(u, v, C') = b_G(u, v, C') - 1$. The primitive walk can be write as

$$W_{\text{rim}}(u, v) = W_{\text{rim}}(u, v, C') = P_{\min}(u, C') \cup P(C') \cup P_{\min}(C', v),$$

where $P(C')$ is a corresponding segment of the odd cycle C' and

$$\gamma(u, v) = \gamma(u, v, C') = d_G(u, C') + |P(C')| + d_G(C', v) - 1.$$

Moreover, for any odd cycle C in G we have $b_G(u, v) = b_G(u, v, C') \leq b_G(u, v, C)$ and $\gamma(u, v) = \gamma(u, v, C') \leq \gamma(u, v, C)$. And if there is a vertex $w \in V(C')$ such that $P_{\min}(u, C') =$

$P_{\min}(u, w)$ and $P_{\min}(C', v) = P_{\min}(w, v)$ (i.e., $|P_{\min}(u, C') \cap P_{\min}(C', v) \cap V(C')| = 1$), then the odd C' is called a *primitive cycle* between u and v . In this time we have

$$\gamma(u, v) = \gamma(u, v, C') = d_G(u, w) + d_G(w, v) + |C'| - 1.$$

Particularly, we put $b(u, C) = b(u, u, C)$, $b(u) = b(u, u)$; $\gamma(u, C) = \gamma(u, u, C)$, $\gamma(u) = \gamma(u, u)$ for convenience.

§3. Constructions of Graphs

Firstly, we define two classes of graphs \mathcal{M}_{n-2} and \mathcal{N}_{n-2} as follows.

(3.1) The set of graphs(*these dashed lines denote possible edges in a graph*)

$$\mathcal{M}_{n-2} = \mathcal{M}_{n-2}^{(1)} \cup \mathcal{M}_{n-2}^{(2)} \cup \mathcal{M}_{n-2}^{(3)} \cup \mathcal{M}_{n-2}^{(4)},$$

where

$\mathcal{M}_{n-2}^{(1)}$: $n = m + 2t + 2$, ($t \geq 1$), $0 \leq i < \frac{m}{2} < j \leq m$.

If $\{x_a y_a \mid 1 \leq a \leq t-1\} \cap E(G) \neq \emptyset$, then $j = i+1$ and $m \equiv 1 \pmod{2}$. Otherwise, $j-i < m$

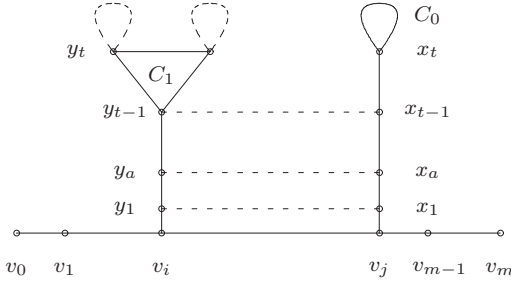

Fig.(1) $\mathcal{M}_{n-2}^{(1)}$

and $m \equiv 0 \pmod{2}$. See Fig.(1).

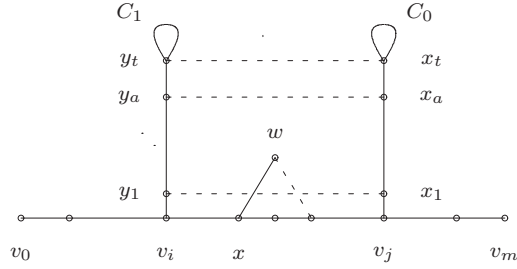

Fig.(2) $\mathcal{M}_{n-2}^{(2)}$

$\mathcal{M}_{n-2}^{(2)}$: $n = m + 2t + 2$, ($t \geq 0$), $0 \leq i < \frac{m}{2} < j \leq m$.

Let $t \geq 1$: If $\{x_k y_k \mid 1 \leq k \leq t\} \cap E(G) \neq \emptyset$, then $j = i + 1$; $|a - b| = 1$ when $\{w x_a, w y_b\} \subseteq E(G)$ ($0 \leq a, b \leq t$), there may be a loop at w when $a = t$ or $b = t$. If $N_G(w) = \{x, y\}$ but not the case as above, $d(x, y) = 2$. If $N_G(w) = \{x\}$ and $d_G(w, P_{uv}) \geq t$, there may be a loop at w ; Otherwise, if $\{w x_a, w y_b\} \subseteq E(G)$ ($0 \leq a, b \leq t$), then $j = i + 1$, $|a - b| = 1$ or $j = i + 2$, $a = b$ ($m \neq 2$) and there may be a loop at w when $a = t$ or $b = t$. If $N_G(w) = \{x, y\}$ but not the case as above, $d(x, y) = 2$. If $N_G(w) = \{x\}$ and $d_G(w, P_{uv}) \geq t$, there may be a loop at w . If there is not any loop at w and $x = v_s$, then $i > 1$ or $j < m$ when $s = \frac{m}{2}$.

Let $t = 0$: There are loops at v_i and v_j ($0 \leq i < \frac{m}{2} < j \leq m$), respectively, and no loop at w but there is a loop C such that $d_G(w, C) < \frac{m}{2}$. There may be loops at the other vertices. See Fig.(2).

$\mathcal{M}_{n-2}^{(3)}$: $n = m + 2t + 2$, ($t \geq 1$), $1 \leq i + 1 < \frac{m}{2} < j \leq m$.

$j - i < m$ when m is an odd number; $j - i < m - 1$ when m is an even number; $j = i + 2$ when $\{x_a y_{a+1} \mid 1 \leq a \leq t\} \cap E(G) \neq \emptyset$. See Fig.(3).

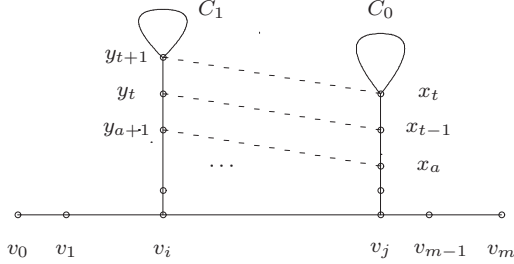
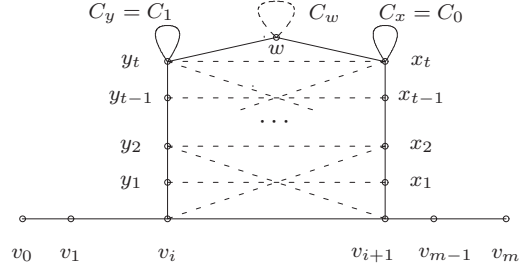
 Fig.(3) $\mathcal{M}_{n-2}^{(3)}$

 Fig.(4) $\mathcal{M}_{n-2}^{(4)}$

$\mathcal{M}_{n-2}^{(4)}$: $n = m + 2t + 2$, ($t \geq 0$).

$t \geq 1$: $i = \frac{1}{2}(m - 1)$. The set of possible chord edges in $C_{ab} = y_b y_{b+1} \cdots y_t w x_t \cdots x_{a+1} x_a y_b$ is $\{x_a y_b \mid 0 \leq a, b \leq t, a = b (\neq 0) \text{ or } |a - b| = 2\}$. There may be a loop at w and $\{C_{ab} \mid a = b + 2\} \cup \{C_y\} \neq \emptyset$, $\{C_{ab} \mid a = b - 2\} \cup \{C_x\} \neq \emptyset$.

$t = 0$: If $i < \frac{1}{2}(m - 1)$, then there are loops at v_y ($\frac{1}{2}(m - 1) < y \leq m$). If $i = \frac{1}{2}(m - 1)$, then there are loops at v_x and v_y ($0 \leq x \leq i < y \leq m$). If $i > \frac{1}{2}(m - 1)$, then there are loops at v_x ($0 \leq x \leq \frac{1}{2}(m - 1)$), there are loops at the other vertices. Fig.(4).

(3.2) The set of graphs

$$\mathcal{N}_{n-2} = \mathcal{N}_{n-2}^{(1)} \cup \mathcal{N}_{n-2}^{(3)} \cup \cdots \cup \mathcal{N}_{n-2}^{(n-1)}, \quad n \equiv 0 \pmod{2},$$

where the set of subgraphs

$$\mathcal{N}_{n-2}^{(d)}, \quad 1 \leq d \leq n - 1, \quad d \equiv 1 \pmod{2}, \quad n \equiv 0 \pmod{2}$$

is constructed in the following.

(1) Let $n = 2r + 2$, take the copies $K_{r+2}^{c(0)}, K_{r+2}^{c(1)}, \dots, K_{r+2}^{c(r-1)}$ of r graphs K_{r+2}^c of order $r + 2$ (The complement of complete graph K_{r+2}) and a complete graph $K_{r+2}^{*(r)}$ with loop at each vertex. Make the *join graph* (the definition of join graph and the complement of graph are referred to [6]): $K_{r+2}^{c(i)} \vee K_{r+2}^{c(i+1)}$, $i = 0, 1, \dots, r - 2$ and $K_{r+2}^{c(r-1)} \vee K_{r+2}^{*(r)}$. Constructing a new graph K as follows:

$$\begin{aligned} K &= \bigcup_{i=0}^{r-2} (K_{r+2}^{c(i)} \vee K_{r+2}^{c(i+1)}) \cup (K_{r+2}^{c(r-1)} \vee K_{r+2}^{*(r)}) \\ &= \underbrace{K_{r+2}^{c(0)} \vee K_{r+2}^{c(1)} \vee \cdots \vee K_{r+2}^{c(r-1)}}_{r \text{ } K_{r+2}^c \text{'s}} \vee K_{r+2}^{*(r)}. \end{aligned}$$

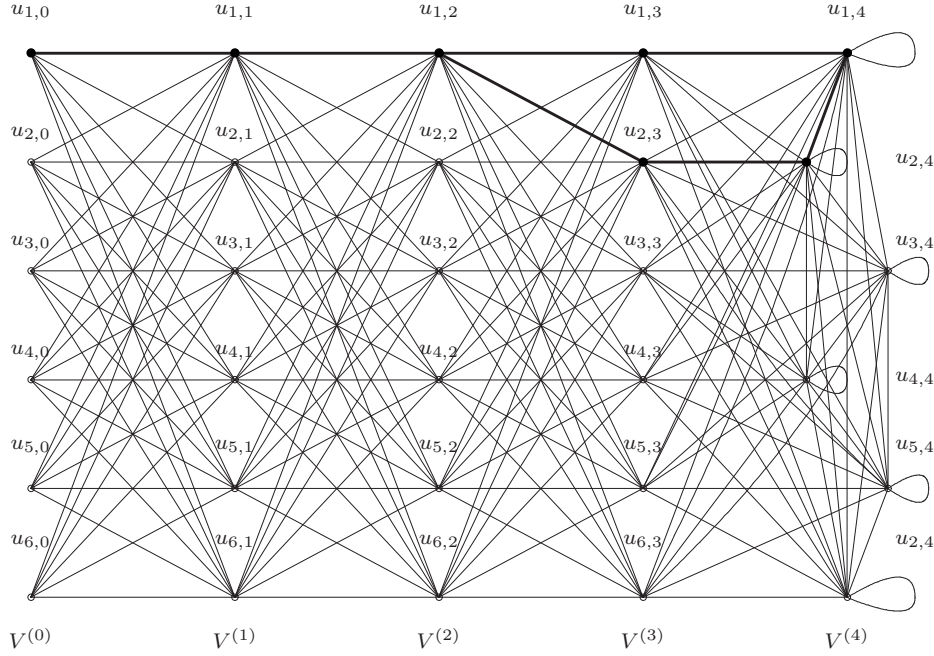
Fig.(5) The graph K with $r = 4$

Suppose that the vertex sets of the graphs $K_{r+2}^{c(0)}, K_{r+2}^{c(1)}, \dots, K_{r+2}^{c(r-1)}$ and $K_{r+2}^{*(r)}$ in order are

$$V^{(j)} = \{u_{i,j} \mid i = 1, 2, \dots, r+2\}, \quad j = 0, 1, \dots, r,$$

then

$$V(K) = V^{(0)} \cup V^{(1)} \cup \dots \cup V^{(r-1)} \cup V^{(r)}.$$

Fig.(5) shows a graph K with $r = 4$.

For $d: 1 \leq d \leq 2r+1, d \equiv 1 \pmod{2}$ given, take a path $P_t = u_{1,0}u_{1,1} \cdots u_{1,t}$ of length $t = r - \frac{1}{2}(d-1)$ in K and an odd cycle $C_d = u_{1,t}u_{1,t+1} \cdots u_{1,r-1}u_{1,r}u_{2,r}u_{2,r-1} \cdots u_{2,t+1}u_{1,t}$ of length d . Constructing a subgraph $K_{(d)}$ of K as follows

$$K_{(d)} = P_t \cup C_d, \quad 1 \leq d \leq 2r+1, \quad d \equiv 1 \pmod{2},$$

which is called a *structure subgraph*. The subgraph in black lines in Fig.(5) shows $K_{(5)}$ ($r = 4$).

(2) Let the set of vertex-induced subgraph of order n containing $K_{(d)}$ of K be $\mathcal{K}^{(d)}$ where $1 \leq d \leq 2r+1, d \equiv 1 \pmod{2}$, and for any graph $N \in \mathcal{K}^{(d)}$ let the spanning subgraph containing $K_{(d)}$ of N be $N_{(d)}$, now we construct the set of graphs $\mathcal{N}^{(d)}$ as follows:

$$\mathcal{N}^{(d)} = \{N_{(d)} \mid N \in \mathcal{K}^{(d)}\}, \quad 1 \leq d \leq 2r+1, \quad d \equiv 1 \pmod{2}.$$

(3) Let the set of the graph $N_{(d)} \in \mathcal{N}^{(d)}$ satisfying the following conditions be

$$\mathcal{N}_{n-2}^{(d)}, \quad 1 \leq d \leq n-1, \quad d \equiv 1 \pmod{2}, \quad n = 2r+2:$$

- (i) $\text{diam}(N_{(d)}) \leq n - 2$;
- (ii) For $d' > d$, $N_{(d)}$ has no the subgraph $K_{(d')}$ to be the structure subgraph of $N_{(d)}$;
- (iii) For the vertex $x \in N = N_{(d)}$ with $d_N(x, C_d) > t$, there must be odd cycle C such that $2d_N(x, C) + |C| \leq n - 1$.

§4. Main Results

Theorem 4.1 G is a primitive graph with order n and for any vertex $w \in V(G)$, $\gamma(w) < \gamma(G) = n - 2$ if and only if $G \in \mathcal{M}_{n-2}$.

Proof We prove the Sufficiency first. Suppose that $G \in \mathcal{M}_{n-2}$, then G is a primitive graph with order n by the construction of \mathcal{M}_{n-2} . For any vertex $w \in V(G)$ we have

$$\begin{aligned} \gamma(w) &\leq \max\{\gamma(v_0), \gamma(v_m)\} = \max\{\gamma(v_0, C_1), \gamma(v_m, C_0)\} \\ &< 2t + m = n - 2 = \gamma(G), \end{aligned}$$

and for any vertices $u, v \in V(G)$ we have

$$\gamma(u, v) \leq \gamma(v_0, v_m) = \gamma(v_0, v_m, C_0) = n - 2.$$

That is $\gamma(G) = \max_{u, v \in V(G)} \gamma(u, v) = \gamma(v_0, v_m) = n - 2$. See Fig.(3-1)~ (3-4).

For the necessity, suppose that G is a primitive graph with order n and

$$\gamma(w) < \gamma(G) = n - 2 \tag{4.1}$$

for any vertex $w \in V(G)$. Without loss of generality, let $u, v \in V(G)$ such that

$$\gamma(u, v) = \max_{x, y \in V(G)} \gamma(x, y) = \gamma(G) = n - 2.$$

According to the discussion in § 2, there must be an odd cycle C_0 such that

$$\gamma(u, v) = \gamma(u, v, C_0) = \gamma(G) = n - 2. \text{ Let}$$

$$P_{uv} = P_{\min}(u, v) = v_0 v_1 \cdots v_i \cdots v_j \cdots v_m,$$

where $v_0 = u$, $v_m = v$, then we know that $n \equiv m \pmod{2}$ by Lemma 2.4.

Suppose that C is an odd cycle in G , then by Lemma 2.4 we have

$$|V(P_{uv}) \cap V(C)| \leq n - \gamma(G) = n - (n - 2) = 2. \tag{4.2}$$

According to (4.2) the following discussion can be partitioned into three cases:

4.1. Suppose that for any odd cycle C in G ,

$$V(P_{uv}) \cap V(C) = \emptyset, \tag{4.3}$$

then $t_0 = d_G(P_{uv}, C_0) \geq 1, d_0 = |C_0| \equiv 1 \pmod{2}$. Now chose such odd cycle C_0 and the shortest (u, v) -path P_{uv} in G such that $2t_0 + d_0$ is as small as possible.

Let

$$\begin{cases} P_0 = P_{\min}(P_{uv}, C_0) = x_0 x_1 \cdots x_{t_0}; \\ V_1 = V(P_{uv} \cup P_0 \cup C_0), \quad V_2 = V(G) \setminus V_1. \end{cases}$$

where $x_0 = v_j$, $x_{t_0} \in V(C_0)$, then $n_1 = |V_1| = m + t_0 + d_0$. Since $n - 2 = \gamma(u, v) = \gamma(u, v, C_0) \leq m + 2t_0 + d_0 - 1$,

$$n_2 = |V_2| = n - (m + t_0 + d_0) \leq n - (n - 1 - t_0) = t_0 + 1. \quad (4.4)$$

4.1.1. Suppose that the odd cycle C' satisfies $\gamma(v) = \gamma(v, C')$ and $P_{\min}(v, C') \cap P_0 \neq \emptyset$, then, by the choice of P_{uv} , C_0 , P_0 and the definition of $\gamma(v)$, we know that $\gamma(v, C') = \gamma(v, C_0)$. By (4.1) we have

$$\gamma(v) = \gamma(v, C_0) = 2d(v, C_0) + d_0 - 1 = 2d(v, x_{t_0}) + d_0 - 1 < n - 2.$$

In this time, if there is an odd cycle C_1 such that $\gamma(u) = \gamma(u, C_1)$ and $P_{\min}(u, C_1) \cap P_0 \neq \emptyset$, we can obtain in the same way that

$$\gamma(u) = \gamma(u, C_0) = 2d(u, C_0) + d_0 - 1 = 2d(u, x_{t_0}) + d_0 - 1 < n - 2.$$

Thus, we have

$$\gamma(G) = \gamma(u, v) = \gamma(u, v, C_0) = d(u, x_{t_0}) + d(v, x_{t_0}) + d_0 - 1 < n - 2 = \gamma(G),$$

a contradiction. So we must have

$$P_{\min}(u, C_1) \cap P_0 = \emptyset. \quad (4.5)$$

Let v_i be the vertex with the maximum suffix in $P_{\min}(u, C_1) \cap P_{uv}$ and

$$d_1 = |C_1|, \quad t_1 = d(v_i, C_1), \quad P_1 = P_{\min}(v_i, C_1) = y_0 y_1 \cdots y_{t_1},$$

where $y_0 = v_i$, $y_{t_1} \in V(C_1)$. By (4.4) and (4.5), we have $P_0 \cap P_1 = \emptyset, i < j$ and

$$1 \leq t_1 \leq t_1 + d_1 - 1 \leq |V_2| \leq t_0 + 1. \quad (4.6)$$

By the choice of P_{uv}, C_0 and P_0 we also have

$$2t_0 + d_0 \leq 2t_1 + d_1. \quad (4.7)$$

From (4.6) and (4.7) we get

$$2t_1 + 2d_1 - 4 + d_0 \leq 2t_0 + d_0 \leq 2t_1 + d_1 \leq 2t_0 + 3,$$

thus $d_0 \leq 3, d_0 + d_1 \leq 4, |t_1 - t_0| \leq 1$.

In all as above we have the following four cases

$$(d_0, d_1) = \begin{cases} (1, 3), & t_1 = t_0 - 1; \\ (3, 1), & t_0 = t_1 - 1; \\ (1, 1), & t_1 = t_0; \\ (1, 1), & t_1 = t_0 + 1, \end{cases} \quad (4.8)$$

and

$$|V(P_{uv} \cup P_0 \cup C_0 \cup P_1 \cup C_1)| = m + t_0 + d_0 + t_1 + d_1 - 1 \leq n. \quad (4.9)$$

Thus

$$\begin{cases} n - 2 = \gamma(u, v) = \gamma(u, v, C_0) \leq m + 2t_0 + d_0 - 1; \\ n - 2 = \gamma(u, v) \leq \gamma(u, v, C_1) \leq m + 2t_1 + d_1 - 1. \end{cases} \quad (4.10)$$

So it follows from (4.9) and (4.10) we have

$$n - 2 \leq m + t_0 + t_1 + \frac{1}{2}(d_0 + d_1) - 1 \leq n - \frac{1}{2}(d_0 + d_1). \quad (4.11)$$

By (4.8) we have four subcases for discussions:

(i) $(d_0, d_1) = (1, 3), t_1 = t_0 - 1$, thus $t_1 \geq 1, t_0 \geq 2$. By (4.10) and (4.11) we have

$$n - 2 = \gamma(u, v, C_0) = m + 2t_0 + d_0 - 1 = m + 2t_1 + d_1 - 1 = \gamma(u, v, C_1) = m + 2t_0,$$

i.e., $n = m + 2t_0 + 2$, therefore by (4.9)

$$|V(P_{uv} \cup P_0 \cup C_0 \cup P_1 \cup C_1)| = n.$$

Suppose that $V(C_1) = \{y_{t_0-1}, y_{t_0}, z\}$, by (4.1) and (4.2) we get

$$v_\lambda x_\alpha \notin E(G), \quad v_\lambda y_\beta \notin E(G), \quad \lambda \neq i, j, \quad 0 < \alpha \leq t_0, \quad 0 < \beta \leq t_0.$$

Note that $\gamma(u) = \gamma(u, C_1) < \gamma(G)$ and $\gamma(v) = \gamma(v, C_0) < \gamma(G)$ we have

$$0 \leq i < \frac{m}{2} < j \leq m. \quad (4.12)$$

If $x_a y_b \in E(G)$, $0 \leq a \leq t_0$, $0 \leq b \leq t_1$, then $a + b + 1 > j - i, i + j + a + b \equiv 1 \pmod{2}$

and

$$\begin{cases} n - 2 = \gamma(u, v, C_0) \leq i + b + 1 + a + m - j + 2(t_0 - a) + d_0 - 1, \\ n - 2 = \gamma(u, v, C_1) \leq i + a + 1 + b + m - j + 2(t_1 - b) + d_1 - 1. \end{cases} \quad (4.13)$$

So $j - i \leq b - a + 1$ and $j - i \leq a - b + 1$. From this we have $j = i + 1$ and $1 \leq a = b \leq t_0 - 1$.

By (4.12) m is an odd. Otherwise, since m being an even, $\gamma(v_{\frac{m}{2}}) < \gamma(G), j - i < m$.

Additionally, it is clever that there may be loops at the vertices y_{t_0} and z , otherwise no any loop except for at x_{t_0} . So $G \in \mathcal{M}_{n-2}^{(1)}(t \geq 2)$. See Fig.(3-1).

(ii) $(d_0, d_1) = (3, 1), t_0 = t_1 - 1$, thus $t_0 \geq 1, t_1 \geq 2$. The discussions of these graphs, which we omit, is analogous to that in (i), and we know that it is must be in $\mathcal{M}_{n-2}^{(1)}(t \geq 2)$.

(iii) $(d_0, d_1) = (1, 1), t_0 = t_1 \geq 1$. It is analogous to (i) that

$$n - 2 = \gamma(u, v, C_0) = \gamma(u, v, C_1) = m + 2t_0,$$

i.e., $n = m + 2t_0 + 2$,

$$v_\lambda x_\alpha \notin E(G), \quad v_\lambda y_\beta \notin E(G), \quad \lambda \neq i, j, \quad 0 < \alpha \leq t_0, \quad 0 < \beta \leq t_0,$$

and

$$0 \leq i < \frac{m}{2} < j \leq m.$$

Thus, by (4.9) we have

$$|V(P_{uv} \cup P_0 \cup P_1)| = n - 1.$$

It is easy to see that the graph G has also another vertex, denoted by w and $1 \leq N_G(w) \leq 2$.

If $x_k y_l \in E(G)$, $0 \leq k, l \leq t_0$, then $j = i + 1, 1 \leq k = l \leq t_0$ and

(a) When $\{w x_a, w y_b\} \subseteq E(G)$, ($0 \leq a, b \leq t_0$), similar to (4.13) we have

$$a + b \equiv 1 \pmod{2}, \quad 1 = j - i \leq \min\{b - a + 2, a - b + 2\}.$$

That is $|a - b| = 1$. It is clear that as $a = t_0$ or $b = t_0$, there may add a loop at vertex w ;

(b) When $N_G(w) = \{x, y\}$ but not the case (a), $d(x, y) = 2$;

(c) When $N_G(w) = \{x\}$ and $d_G(w, P_{uv}) \geq t_0$, there may add a loop at vertex w .

If there is not $x_k y_l \in E(G)$, $0 \leq k, l \leq t_0$, then we have by similar discussions:

(a') When $\{w x_a, w y_b\} \subseteq E(G)$, ($0 \leq a, b \leq t_0$), we have $j = i + 1$, $|a - b| = 1$ or $j = i + 2$, $a = b$, but $m \neq 2$ and as $a = t_0$ or $b = t_0$, there may add a loop at vertex w ;

(b') When $N_G(w) = \{x, y\}$ but not the case (a'), $d(x, y) = 2$;

(c') When $N_G(w) = \{x\}$ and $d_G(w, P_{uv}) \geq t_0$, there may add a loop at vertex w . If there is not any loop at vertex w and $x = v_s$, then by $\gamma(w) < \gamma(G)$, $i > 1$ or $j < m$ as $s = \frac{m}{2}$.

To sum up we have $G \in \mathcal{M}_{n-2}^{(2)}(t \geq 1)$ (See Fig.(3-2)).

(iv) $(d_0, d_1) = (1, 1)$, $t_1 = t_0 + 1 \geq 2$. From (4.9) we get

$$|V(P_{uv} \cup P_0 \cup P_1)| = n.$$

And from (4.10) we have

$$n - 2 = \gamma(G) = \gamma(u, v, C_0) = m + 2t_0, \quad \gamma(u, v, C_1) \leq m + 2t_1 = m + 2t_0 + 2.$$

i.e., $n = m + 2t_0 + 2$, and from (4.1) and (4.2), we have

$$v_\lambda x_\alpha \notin E(G), \quad \lambda \neq j, \quad 0 < \alpha \leq t_0; \quad v_\mu y_\beta \notin E(G), \quad 0 \leq \mu < i, \quad 0 < \beta \leq t_1.$$

Sine $\gamma(u) = \gamma(u, C_1) = 2i + 2t_0 + 2 < m + 2t_0$, $i + 1 < \frac{m}{2}$, thus

$$1 \leq i + 1 < \frac{m}{2} < j \leq m. \quad (4.14)$$

Now, if $v_\mu y_\beta \notin E(G)$, $\mu > i$, $1 \leq \beta \leq t_0 + 1$, then by (4.1) we have $j - i < m$ as m is odd and $j - i < m - 1$ as m is even.

If $x_a y_b \in E(G)$, $0 \leq a \leq t_0, 0 \leq b \leq t_1$, then $a + b + i + j \equiv 1 \pmod{2}$,

$$\begin{cases} n - 2 = \gamma(u, v, C_0) \leq i + b + 1 + a + m - j + 2(t_0 - a), \\ n - 2 = \gamma(u, v, C_1) \leq i + b + 1 + a + m - j + 2(t_1 - b). \end{cases}$$

Thus $1 < j - i \leq b - a + 1$ and $1 < j - i \leq a - b + 3$. this means that $j = i + 2$ and $b = a + 1$. So $G \in \mathcal{M}_{n-2}^{(3)}$ (See Fig.(3-3)).

If $v_\mu y_\beta \in E(G)$, ($\mu > i$), then it is must be that $y_1 v_{i+2}$ and $i + 2 \leq j$ by (4.14). The case similar to (b) in (iii).

4.1.2. Suppose that the odd cycle C' satisfies $\gamma(v) = \gamma(v, C')$ and $P_{\min}(v, C') \cap P_0 = \emptyset$, then there is also an odd cycle C'' such that $\gamma(u) = \gamma(u, C'')$ and $P_{\min}(u, C'') \cap P_0 = \emptyset$. Otherwise, similar to 4.1.1. Let

$$P' = P_{\min}(P_{uv}, C'), \quad P'' = P_{\min}(P_{uv}, C'')$$

and writing $t' = d_G(P_{uv}, C')$, $d' = |C'|$; $t'' = d_G(P_{uv}, C'')$, $d'' = |C''|$, therefore

$$|V(P_{uv} \cup P_0 \cup P' \cup P'' \cup C_0 \cup C' \cup C'')| = m + t_0 + t' + t'' + d_0 + d' + d'' - 2 \leq n.$$

Since

$$\begin{cases} n - 2 = \gamma(u, v, C_0) \leq m + 2t_0 + d_0 - 1, \\ n - 2 \leq \gamma(u, v, C') \leq m + 2t' + d' - 1, \\ n - 2 \leq \gamma(u, v, C'') \leq m + 2t'' + d'' - 1. \end{cases}$$

Thus, we have

$$\begin{aligned} n - 2 &\leq m + \frac{2}{3}(t_0 + t' + t'') + \frac{1}{3}(d_0 + d' + d'') - 1 \\ &\leq n + 1 - \frac{1}{3}(t_0 + t' + t'') - \frac{2}{3}(d_0 + d' + d'') \\ &\leq n - 2. \end{aligned}$$

i.e.,

$$t_0 = t' = t'' = 1, \quad d_0 = d' = d'' = 1.$$

So $G \in \mathcal{M}_{n-2}^{(2)}(t = 1)$ (See Fig.(3-2)).

4.2. Suppose that there is an odd cycle C in G such that

$$V(P_{uv}) \cap V(C) = \{v_i, v_\lambda\}, \quad (i < \lambda). \quad (4.15)$$

Then from (4.2) we see that $\lambda = i + 1$, thus

$$n - 2 = \gamma(u, v) \leq i + (m - \lambda) + |C| - 2 = m + |C| - 3 = |V(P_{uv} \cup C)| - 2 \leq n - 2,$$

i.e.,

$$V(P_{uv} \cup C) = V(G), \quad n - 2 = \gamma(u, v) = \gamma(G) = m + |C| - 3,$$

or

$$G = P_{uv} \cup C, \quad n = m + |C| - 1. \quad (4.16)$$

In the same time from (4.2), also we see that

$$N[C_0 - \{v_i, v_{i+1}\}] \cap V(P_{uv}) = \{v_i, v_{i+1}\}.$$

By (4.2) we have $v_i v_{i+1} \in C$, and $\gamma(u, v) = \gamma(u, v, C)$, i.e., putting $C = C_0$. Let $C_0 = y_0 y_1 \cdots y_{t_0} w x_{t_0} \cdots x_1 x_0 y_0$ where $y_0 = v_i, x_0 = v_{i+1}, t_0 \geq 0$, then $|C_0| = 2t_0 + 3$, that is $n = m + 2t_0 + 2$.

If there is $x_a y_b \in E(G)$, $0 \leq a, b \leq t_0$, then by $\gamma(u, v) = \gamma(u, v, C_0)$ we have $|a - b| \equiv 0 \pmod{2}$. In this time we have the odd cycle $C_{ab} = y_b y_{b+1} \cdots y_{t_0} w x_{t_0} \cdots x_{a+1} x_a y_b$, and so

$$\begin{cases} n - 2 \leq \gamma(u, v, C_{ab}) \leq m + 2a + 2t_0 - a - b + 2, \\ n - 2 \leq \gamma(u, v, C_{ab}) \leq m + 2b + 2t_0 - a - b + 2. \end{cases}$$

That is $|a - b| \leq 2$, or $a = b \neq 0$ ($t_0 \geq 1$) or $|a - b| = 2$ ($t_0 \geq 2$).

It is easily seen that the all of odd cycles in G is included in $\mathcal{Z} = \{C_{ab} \mid 0 \leq a, b \leq t_0, a = b \neq 0 \text{ or } |a - b| = 2\}$ where $C_0 = C_{00}$ except for possible loops C_y at y_{t_0} , C_x at x_{t_0} and C_w at w .

If there exists $C_{ab}, C_{a'b'} \in \mathcal{Z}$ in G such that $\gamma(u) = \gamma(u, C_{ab}) < n - 2$, $\gamma(v) = \gamma(v, C_{a'b'}) < n - 2$, then from (4.1) we get

$$\begin{cases} 2i + 2b + 2t_0 + 2 - a - b \leq n - 3, \\ 2(m - i - 1) + 2a' + 2t_0 + 2 - a' - b' \leq n - 3, \end{cases}$$

note that $n = m + 2t_0 + 2$, the formula as above equivalent to

$$\begin{cases} 2i \leq m - 3 + a - b, \\ 2(m - i - 1) \leq m - 3 + b' - a' \end{cases}$$

i.e.,

$$a = b + 2, \quad a' = b' - 2, \quad i = \frac{1}{2}(m - 1).$$

Otherwise, we must have $\gamma(u) = \gamma(u, C_y) < n - 2$ and $\gamma(v) = \gamma(v, C_x) < n - 2$, i.e.,

$$\begin{cases} 2i + 2t_0 \leq n - 3, \\ 2(m - i - 1) + 2t_0 \leq n - 3, \end{cases}$$

From this we can get $i = \frac{1}{2}(m - 1)$, and there are loops C_y at y_{t_0} and C_x at x_{t_0} .

To sum up, we obtain that

$$\begin{cases} \{C_{ab} \mid 0 \leq a, b \leq t_0, a = b + 2\} \cup \{C_y\} \neq \emptyset; \\ \{C_{ab} \mid 0 \leq a, b \leq t_0, a = b - 2\} \cup \{C_x\} \neq \emptyset. \end{cases}$$

Evidently, this result is the same as the case of no any $x_a y_b \in E(G)$, $0 \leq a, b \leq t_0$ but $t_0 \geq 1$.

When $t_0 = 0$, i.e., $|C_0| = 3$, $n - 2 = \gamma(u, v) = \gamma(u, v, C_0) = \gamma(G) = m$. Set $C_0 = v_i v_{i+1} w v_i$, then there are loops at vertex v_x and v_y as $i = \frac{1}{2}(m - 1)$ where $0 \leq x \leq i = \frac{1}{2}(m - 1) < y \leq m$, and there may be loops at the rest vertices; There must be a loop at v_y as $i < \frac{1}{2}(m - 1)$ where $\frac{1}{2}(m - 1) < y \leq m$, and there may be loops at the rest vertices; there must be a loop at v_x as $i > \frac{1}{2}(m - 1)$ where $0 \leq x \leq \frac{1}{2}(m - 1)$, and there may be loops at the rest vertices. So $G \in \mathcal{M}_{n-2}^{(4)}$ (See Fig.(3-4)).

4.3. There is an odd cycle C such that

$$V(P_{uv}) \cap V(C) = \{v_i\}, \quad (4.17)$$

but there is not odd cycle C' such that $|V(P_{uv}) \cap V(C')| \geq 2$. Thus, we have

$$n - 2 = \gamma(u, v) \leq \gamma(u, v, C) = m + |C| - 1 = |V(P_{uv} \cup C)| - 1 \leq n - 1.$$

Since $n \equiv m \pmod{2}$,

$$n - 2 = \gamma(u, v) = \gamma(u, v, C) = m + |C| - 1, \quad |V(P_{uv} \cup C)| = n - 1,$$

i.e., $n = m + |C| + 1$. Evidently, there is only one vertex w in G except for the vertices of $V(P_{uv} \cup C)$ and $N(C - \{v_i\}) \cap V(P_{uv}) = \{v_i\}$. This indicates that $C = C_0$ and $|C_0| \leq 3$, otherwise, there must have $\gamma(u) \geq \gamma(G)$ or $\gamma(v) \geq \gamma(G)$, contradicts to (4.1).

When $|C_0| = 3$ we have $\gamma(G) = m + 2$ and $n = m + 4$. There is no any loop at the vertices on P_{uv} . By (4.1) we have $G \in \mathcal{M}_{n-2}^{(1)}(t = 1)$ (See Fig.(3-1)).

When $|C_0| = 1$ we have $\gamma(G) = m$ and $n = m + 2$. By (4.1) the set of graphs have the characteristic: there are loops at v_i and v_j as $0 \leq i < \frac{m}{2} < j \leq m$, there is no any loop at w , and there may be loops at the rest vertices. There exists a loop C such that $d_G(w, C) < \frac{m}{2}$. So $G \in \mathcal{M}_{n-2}^{(2)}(t = 0)$ (See Fig.(3-2)).

The proof is complete. \square

Theorem 4.2 *Suppose that G is a primitive graph with order n , then there exists a vertex $w \in V(G)$ such that $\gamma(w) = \gamma(G) = n - 2$ if and only if $G \in \mathcal{N}_{n-2}$.*

Proof For the sufficiency, suppose that $G \in \mathcal{N}_{n-2}$, without loss of generality suppose that $G \in \mathcal{N}_{n-2}^{(d)}, 1 \leq d \leq 2r + 1, d \equiv 1 \pmod{2}$. Since $\text{diam}(G) \leq n - 2$, G is connected and it is clear that there is at least an odd cycle C_d in G . By Lemma 2.1 we know that G is a primitive graph and $|V(G)| = n_1 + n_2 = 2t + d + 1 = n$.

In the following, we need only to prove two results:

$$(1) \gamma(u_0) = n - 2.$$

$$\text{Evidently, } \gamma(u_0, C_d) = 2d_G(u_0, C_d) + |C_d| - 1 = 2t + d - 1 = n - 2.$$

Suppose that there is any odd cycle C in G such that $\gamma(u_0, C) < n - 2 = 2r$, then $2d_G(u_0, C) + |C| - 1 < 2r$, i.e.,

$$d_G(u_0, C) + \frac{1}{2}(|C| - 1) < r.$$

This means that there is an odd cycle C in the vertex-induced subgraph $G[U']$ in G where

$$U' = \{u \mid d_G(u_0, u) < r, \quad u \in V(G)\}.$$

This is impossible, since $G[U']$ is the subgraph of the vertex-induced subgraph $K[V']$ in K where

$$V' = \{u \mid d_K(u_0, u) < r, \quad u \in V(K)\},$$

and $K[V']$ is a bipartite graph. So $\gamma(u_0) = \gamma(u_0, C_d) = n - 2$.

$$(2) \forall u, v \in V(G), \quad \gamma(u, v) \leq n - 2.$$

When $u = v$, If $d_G(u, C_d) \leq t$, then

$$\gamma(u) \leq \gamma(u, C_d) = 2t + d - 1 = 2r = n - 2;$$

If $d_G(u, C_d) > t$, then by the constructed condition (iii) of G we see that there exists an odd cycle C in G such that $2d_G(u, C) + |C| \leq n - 1$, that is

$$\gamma(u) \leq \gamma(u, C) = 2d_G(u, C) + |C| - 1 \leq n - 2.$$

Thus, we get $\gamma(u, v) \leq n - 2$.

When $u \neq v$, if $d_G(u, C_d) + d_G(v, C_d) \leq 2t$, then

$$\gamma(u, v) \leq \gamma(u, v, C_d) \leq 2t + d - 1 = n - 2;$$

If $d_G(u, C_d) + d_G(v, C_d) > 2t$, it might just as well suppose that $d_G(u, C_d) > t$, then by the constructed condition (iii) of G we also see that there exists an odd cycle C in G such that

$$2d_G(u, C) + |C| \leq n - 1.$$

By considering the shortest path $P_{\min}(u, C)$ from u to C and $P_{\min}(u_0, C_d)$ from u_0 to C_d , if they intersect each other, let w be the first intersect vertex of $P_{\min}(u, C)$ from u to C and $P_{\min}(u_0, C_d)$, then $d_G(u, w) > d_G(u_0, w)$. Thus

$$\begin{aligned} \gamma(u_0) &\leq \gamma(u_0, C) \leq 2(d_G(u_0, w) + d_G(w, C)) + |C| - 1 \\ &< 2(d_G(u, w) + d_G(w, C)) + |C| - 1 \\ &= 2d_G(u, C) + |C| - 1 \\ &\leq n - 2 = \gamma(u_0), \end{aligned}$$

a contradiction. Therefore, there are no any intersect vertex between $P_{\min}(u, C)$ and $P_{\min}(u_0, C_d)$. Thus, by the connectivity of G and the condition $n_2 = t + 1$, we have $d_G(u, C_d) = t + 1$ and $d_G(v, C_d) = t$. This means that $uv \in E(G)$ or $v = u_0$.

If $uv \in E(G)$, then

$$\begin{aligned} \gamma(u, v) &\leq \gamma(u, v, C) = d_G(u, C) + d_G(v, C) + |C| - 1 \\ &< 2d_G(u, C) + |C| - 1 \leq n - 2; \end{aligned}$$

If $v = u_0$, then

$$\begin{aligned} \gamma(u, v) &\leq \gamma(u, u_0, C_d) \leq d_G(u, C_d) + d_G(u_0, C_d) + |C_d| - 2 \\ &= 2t + d - 1 = n - 2. \end{aligned}$$

To sum up, we get $\forall u, v \in V(G)$, $\gamma(u, v) \leq n - 2$.

For the necessity, suppose that G is a primitive graph with order n , then there must be a vertex u_0 and an odd cycle C in G such that $\gamma(u_0) = \gamma(u_0, C) = \gamma(G) = n - 2$, choosing such vertex u_0 and odd cycle C that the length $d = |C|$ as large as possible and writing $C = C_d$. By the Lemma 2.4, we have $\gamma(G) = \gamma(u_0) \equiv d_G(u_0, u_0) = 0 \pmod{2}$. So, let $\gamma(G) = 2r$, thus $n = 2r + 2$.

It is clear that C_d is a primitive cycle at vertex u_0 , let $t = d_G(u_0, C_d)$, then $\gamma(u_0) = 2t + d - 1 = 2r$. So $t = r - \frac{1}{2}(d - 1), 1 \leq d \leq 2r + 1$. Suppose that

$$P_t = P_{\min}(u_0, C_d) = u_0 u_1 \cdots u_t, \quad C_d = u_t u_{t+1} \cdots u_{t+d-1} u_t,$$

and write

$$\begin{cases} V_1(t, d) = V(P_t \cup C_d), & V_2(t, d) = V(G) - V_1(t, d); \\ E_1(t, d) = E(P_t \cup C_d), & E_2(t, d) = E(G) - E_1(t, d). \end{cases}$$

Then, we calculate

$$n_1 = |V_1(t, d)| = t + d, \quad n_2 = |V_2(t, d)| = t + 1, \quad n = 2t + d + 1.$$

What is mentioned as above indicates that there must be the structure subgraph $K_{(d)} = P_t \cup C_d$ in G . In order to prove $G \in \mathcal{N}_{n-2}^{(d)} \subseteq \mathcal{N}_{n-2}$, it is suffice to prove that (a) The graph G satisfies the constructed conditions (i), (ii) and (iii) of the set of $\mathcal{N}_{n-2}^{(d)}$; (b) The graph G is a subgraph of K .

(a) By Lemma 2.4 we get $\text{diam}(G) \leq \gamma(G) = 2r = n - 2$, so the condition (i) holds. By the choice of C_d we know that for $d' > d$ there is not the structure subgraph $K(d')$ in G , so the condition (ii) holds. Suppose that there exists a vertex x in G such that $d_G(x, C_d) > t$, then $\gamma(x, C_d) = 2d_G(x, C_d) + d - 1 > 2t + d - 1 = 2r$. If $2d_G(x, C') + |C'| > n - 1$ for all odd cycle C' different from odd C_d in G , then also $\gamma(x, C') = 2d_G(x, C') + |C'| - 1 > n - 2 = 2r$. So $\gamma(G) \geq \gamma(x) > 2r = \gamma(G)$, a contradiction. Therefore the condition (iii) holds too.

(b) Suppose that the vertex set $V(G)$ of G is divided into as follows:

$$V(G) = U_0 \cup U_1 \cup \cdots \cup U_{r-1} \cup U_r,$$

in which $U_i = \{u \mid d_G(u_0, u) = i, u \in V(G)\}, i = 0, 1, 2, \dots, r-1, U_r = \{u \mid d_G(u_0, u) \geq r, u \in V(G)\}$.

Firstly, we prove that the induced vertex subgraphs $G[U_i]$ all are zero graphs, $i = 0, 1, 2, \dots, r-1$. Otherwise, there must be odd cycle in the vertex-induced subgraph $G' = G[U_0 \cup U_1 \cup \cdots \cup U_{r-1}]$. Let C be an odd cycle in G' , then $d_{G'}(u_0, C) + \frac{1}{2}(|C| - 1) < r$. Thus, $\gamma(u_0) \leq \gamma(u_0, C) = 2d_{G'}(u_0, C) + |C| - 1 < 2r = \gamma(u_0)$, a contradiction.

Secondly, we prove that $G[U_r]$ is a subgraph of $K_{r+2}^{(r)}$. By the definition of $K_{r+2}^{(r)}$, it is suffice to prove that $|U_r| \leq |K_{r+2}^{(r)}| = r + 2$. In fact, when $d = 1$ since $|U_i| \geq 1, i = 0, 1, \dots, r-1$, we have $2r + 2 = |V(G)| \geq r + |U_r|$, i.e., $|U_r| \leq r + 2$. When $d \geq 3$ since $|U_i| \geq 1, i = 0, 1, \dots, t, |U_j| \geq 2, j = t + 1, \dots, r-1$, we have $2r + 2 = |V(G)| \geq t + 1 + 2(r - t - 1) + |U_r|$, i.e., $|U_r| \leq t + 3 = r - \frac{1}{2}(d - 1) + 3 \leq r + 2$.

To sum up, we obtain $G \in \mathcal{N}_{n-2}^{(d)} \subseteq \mathcal{N}_{n-2}$. The theorem is proved completely. \square

Theorem 4.3 Suppose that \mathbf{A} is a symmetric primitive matrix with order n , then $\gamma(\mathbf{A}) = n - 2$ if and only if $G(\mathbf{A}) \in \mathcal{M}_{n-2} \cup \mathcal{N}_{n-2}$.

Proof According to Theorem 4.1 and Theorem 4.2 the theory holds. \square

Acknowledgement

The author appreciates Professors Kemin Zhang and Boying Wang for their valuable suggestions on this paper.

References

- [1] Shao J. Y., The Exponent Set of Symmetric Primitive Matrices, *Scientia Sinica(A)*, 1986, 9: 931-939.
- [2] Liu B. L., McKay B. D., Wormald, N. C., Zhang K. M., The Exponent Set of Symmetric Primitive $(0,1)$ Matrices with Zero Trace, *Linear Algebra and its Applications*, 1990, 133: 121-131.
- [3] Li G. R., Song W. J., Jin Z., The Characterization of Symmetric Primitive Matrices with Exponent $2n - 6$ (in Chinese), *Journal of Nanjing University*, 1991, 27: 87-92.
- [4] Cai J. L., Zhang K. M., The Characterization of Symmetric Primitive Matrices with Exponent $2n - 2r (\geq n)$, *Linear and Multilinear Algebra*, 1995, 39: 391-396.
- [5] Cai J. L., Wang B. Y., The Characterization of Symmetric Primitive Matrices with Exponent $n - 1$, *Linear Algebra and its Applications*, 2003, 364: 135-145.
- [6] Bondy J. A., Murty U. S. R., *Graph theory with applications*, London: Macmillan Press, 1976.
- [7] L.F.Mao, Combinatorial speculation and the combinatorial conjecture for mathematics, *Selected Papers on Mathematical Combinatorics(I)*, 1-22, World Academic Union, 2006.

Characterizations of Some Special Space-like Curves in Minkowski Space-time

Melih Turgut and Suha Yilmaz

(Department of Mathematics of Dokuz Eylul University, 35160 Buca, Izmir, Turkey)

Email: melih.turgut@gmail.com

Abstract: In this work, a system of differential equation on Minkowski space-time E_1^4 , a special case of Smarandache geometries ([4]), whose solution gives the components of a space-like curve on Frenet axis is constructed by means of Frenet equations. In view of some special solutions of this system, characterizations of some special space-like curves are presented.

Key words: Minkowski space-time, Frenet frame, Space-like curve.

AMS(2000): 53C50, 51B20.

§1. Introduction

It is safe to report that the many important results in the theory of the curves in E^3 were initiated by G. Monge; and G. Darboux pioneered the moving frame idea. Thereafter, F. Frenet defined his moving frame and his special equations which play important role in mechanics and kinematics as well as in differential geometry (for more details see [2]). At the beginning of the twentieth century, A.Einstein's theory opened a door of use of new geometries. One of them, Minkowski space-time, which is simultaneously the geometry of special relativity and the geometry induced on each fixed tangent space of an arbitrary Lorentzian manifold - a special case of Smarandache geometries ([4]), was introduced and some of classical differential geometry topics have been treated by the researchers.

In the case of a differentiable curve, at each point a tetrad of mutually orthogonal unit vectors (called tangent, normal, first binormal and second binormal) was defined and constructed, and the rates of change of these vectors along the curve define the curvatures of the curve in four dimensional space [1].

In the present paper, we write some characterizations of space-like curves by the components of the position vector according to Frenet frame. Moreover, we obtain important relations among curvatures of space-like curves.

§2. Preliminaries

¹Received February 12, 2008. Accepted March 20, 2008.

To meet the requirements in the next sections, here, the basic elements of the theory of curves in the space E_1^4 are briefly presented (a more complete elementary treatment can be found in [1]).

Minkowski space-time E_1^4 is an Euclidean space E^4 provided with the standard flat metric given by

$$g = -dx_1^2 + dx_2^2 + dx_3^2 + dx_4^2,$$

where (x_1, x_2, x_3, x_4) is a rectangular coordinate system in E_1^4 .

Since g is an indefinite metric, recall that a vector $v \in E_1^4$ can have one of the three causal characters; it can be space-like if $g(v, v) > 0$ or $v = 0$, time-like if $g(v, v) < 0$ and null (light-like) if $g(v, v) = 0$ and $v \neq 0$. Similarly, an arbitrary curve $\alpha = \alpha(s)$ in E_1^4 can be locally be space-like, time-like or null (light-like), if all of its velocity vectors $\alpha'(s)$ are respectively space-like, time-like or null. Also, recall the norm of a vector v is given by $\|v\| = \sqrt{|g(v, v)|}$. Therefore, v is a unit vector if $g(v, v) = \pm 1$. Next, vectors v, w in E_1^4 are said to be orthogonal if $g(v, w) = 0$. The velocity of the curve $\alpha(s)$ is given by $\|\alpha'(s)\|$. The hypersphere of center $m = (m_1, m_2, m_3, m_4)$ and radius $r \in R^+$ in the space E_1^4 defined by

$$H_0^3(m, r) = \{\alpha = (\alpha_1, \alpha_2, \alpha_3, \alpha_4) \in E_1^4 : g(\alpha - m, \alpha - m) = -r^2\}. \quad (1)$$

Denote by $\{T(s), N(s), B_1(s), B_2(s)\}$ the moving Frenet frame along the curve $\alpha(s)$ in the space E_1^4 . Then T, N, B_1, B_2 are, respectively, the tangent, the principal normal, the first binormal and the second binormal vector fields. Space-like or time-like curve $\alpha(s)$ is said to be parameterized by arclength function s , if $g(\alpha'(s), \alpha'(s)) = \pm 1$. Let $\vartheta = \vartheta(s)$ be a curve in E_1^4 . If tangent vector field of this curve is forming a constant angle with a constant vector field U , then this curve is called an inclined curve.

Let $\alpha(s)$ be a curve in the space-time E_1^4 , parameterized by arclength function s . Then for the unit speed curve α with non-null frame vectors the following Frenet equations are given in [5] :

$$\begin{bmatrix} T' \\ N' \\ B_1' \\ B_2' \end{bmatrix} = \begin{bmatrix} 0 & \kappa & 0 & 0 \\ \mu_1 \kappa & 0 & \mu_2 \tau & 0 \\ 0 & \mu_3 \tau & 0 & \mu_4 \sigma \\ 0 & 0 & \mu_5 \sigma & 0 \end{bmatrix} \begin{bmatrix} T \\ N \\ B_1 \\ B_2 \end{bmatrix}. \quad (2)$$

Due to character of α , we write following subcases.

Case 1 α is a space-like vector. Thus T is a space-like vector. Now, we distinguish according to N .

Case 1.1 If N is space-like vector, then B_1 can have two causal characters.

Case 1.1.1 B_1 is space-like vector, then μ_i ($1 \leq i \leq 5$) read

$$\mu_1 = \mu_3 = -1, \quad \mu_2 = \mu_4 = \mu_5 = 1,$$

and T, N, B_1 and B_2 are mutually orthogonal vectors satisfying equations

$$g(T, T) = g(N, N) = g(B_1, B_1) = 1, g(B_2, B_2) = -1.$$

Case 1.1.2 B_1 is time-like vector, then μ_i ($1 \leq i \leq 5$) read

$$\mu_1 = -1, \mu_2 = \mu_3 = \mu_4 = \mu_5 = 1,$$

and T, N, B_1 and B_2 are mutually orthogonal vectors satisfying equations

$$g(T, T) = g(N, N) = g(B_2, B_2) = 1, g(B_1, B_1) = -1.$$

Case 1.2 N is time-like vector. Then μ_i ($1 \leq i \leq 5$) read

$$\mu_1 = \mu_2 = \mu_3 = \mu_4 = 1, \mu_5 = -1,$$

and T, N, B_1 and B_2 are mutually orthogonal vectors satisfying equations

$$g(T, T) = g(B_1, B_1) = g(B_2, B_2) = 1, g(N, N) = -1.$$

Case 2 α is a time-like vector. Thus T is a time-like vector. Then μ_i ($1 \leq i \leq 5$) read

$$\mu_1 = \mu_2 = \mu_4 = 1, \mu_3 = \mu_5 = -1,$$

and T, N, B_1 and B_2 are mutually orthogonal vectors satisfying equations

$$g(T, T) = -1, g(N, N) = g(B_1, B_1) = g(B_2, B_2) = 1.$$

Here κ, τ and σ are, respectively, first, second and third curvature of the curve α .

In another work [3], authors wrote a characterization of space-like curves whose image lies on H_0^3 with following statement.

Theorem 2.1 *Let $\alpha = \alpha(s)$ be an unit speed space-like curve with curvatures $\kappa \neq 0, \tau \neq 0$ and $\sigma \neq 0$ in E_1^4 . Then α lies on H_0^3 if and only if*

$$\frac{\sigma}{\tau} \frac{d}{ds} \left(\frac{1}{\kappa} \right) - \frac{d}{ds} \left\{ \frac{1}{\sigma} \left[\frac{\tau}{\kappa} + \frac{d}{ds} \left(\frac{1}{\tau} \frac{d}{ds} \left(\frac{1}{\kappa} \right) \right) \right] \right\} = 0. \quad (3)$$

In the same space, Yilmaz (see [6]) gave a formulation about inclined curves with the following theorem.

Theorem 2.2 *Let $\alpha = \alpha(s)$ be a space-like curve in E_1^4 parameterized by arclength. The curve α is an inclined curve if and only if*

$$\frac{\kappa}{\tau} = A \cosh \left(\int_0^s \sigma ds \right) + B \sinh \left(\int_0^s \sigma ds \right), \quad (4)$$

where $\tau \neq 0$ and $\sigma \neq 0, A, B \in R$.

In this paper, we shall study these equations in Case 1.1.1.

§3. Characterizations of Some Special Space-Like Curves in E_1^4

Let us consider an unit speed space-like curve $\xi = \xi(s)$ with Frenet equations in case 1.1.1 in Minkowski space-time. We can write this curve respect to Frenet frame $\{T, N, B_1, B_2\}$ as

$$\xi = \xi(s) = m_1T + m_2N + m_3B_1 + m_4B_2, \quad (5)$$

where m_i are arbitrary functions of s . Differentiating both sides of (5), and considering Frenet equations, we easily have a system of differential equation as follow:

$$\left\{ \begin{array}{l} \frac{dm_1}{ds} - m_2\kappa - 1 = 0 \\ \frac{dm_2}{ds} + m_1\kappa - m_3\tau = 0 \\ \frac{dm_3}{ds} + m_2\tau + m_4\sigma = 0 \\ \frac{dm_4}{ds} + m_3\sigma = 0 \end{array} \right\}. \quad (6)$$

This system's general solution have not been found. Owing to this, we give some special values to the components and curvatures. By this way, we write some characterizations.

Case 1 Let us suppose the curve $\xi = \xi(s)$ lies fully NB_1B_2 subspace. Thus, $m_1 = 0$. Using (6)₁, (6)₂ and (6)₃ we have other components, respectively,

$$\left\{ \begin{array}{l} m_2 = -\frac{1}{\kappa} \\ m_3 = -\frac{1}{\tau} \frac{d}{ds} \left(\frac{1}{\kappa} \right) \\ m_4 = \frac{1}{\sigma} \left[\tau + \frac{d}{ds} \left(\frac{1}{\tau} \frac{d}{ds} \left(\frac{1}{\kappa} \right) \right) \right] \end{array} \right\}. \quad (7)$$

These obtained components shall satisfy (6)₄. And therefore, we get following differential equation:

$$\frac{d}{ds} \left\{ \frac{1}{\sigma} \left[\tau + \frac{d}{ds} \left(\frac{1}{\tau} \frac{d}{ds} \left(\frac{1}{\kappa} \right) \right) \right] \right\} - \frac{\sigma}{\tau} \frac{d}{ds} \left(\frac{1}{\kappa} \right) = 0. \quad (8)$$

By the theorem (2.1), (8) follows that $\xi = \xi(s)$ lies on $H_0^3(r)$. Via this case, we write following results.

Corollary 3.1 *Let $\xi = \xi(s)$ be an unit speed space-like curve with curvatures $\kappa \neq 0, \tau \neq 0$ and $\sigma \neq 0$ in E_1^4 .*

(i) *If the first component of position vector of ξ on Frenet axis is zero, then ξ lies on H_0^3 .*

(ii) *All space-like curves which lies fully NB_1B_2 subspace are spherical curves. And position vector of such curves can be written as*

$$\xi = -\frac{1}{\kappa}N - \frac{1}{\tau} \frac{d}{ds} \left(\frac{1}{\kappa} \right) B_1 + \frac{1}{\sigma} \left[\tau + \frac{d}{ds} \left(\frac{1}{\tau} \frac{d}{ds} \left(\frac{1}{\kappa} \right) \right) \right] B_2. \quad (9)$$

Case 2 Let us suppose the curve $\xi = \xi(s)$ lies fully TB_1B_2 subspace. In this case $m_2 = 0$. Solution of (6) yields that

$$\left\{ \begin{array}{l} m_1 = s + c \\ m_3 = -\frac{\kappa}{\tau}(s + c) \\ m_4 = \frac{1}{\sigma} \frac{d}{ds} \left(\frac{\kappa}{\tau}(s + c) \right) \end{array} \right\}, \quad (10)$$

where c is a real number. Using (6)₄, we form a differential equation respect to $\frac{\kappa}{\tau}(s + c)$ as

$$\frac{d}{ds} \left\{ \frac{1}{\sigma} \frac{d}{ds} \left(\frac{\kappa}{\tau}(s + c) \right) \right\} - \frac{\sigma\kappa}{\tau}(s + c) = 0. \quad (11)$$

Using an exchange variable $t = \int_0^s \sigma ds$ in (11), we easily have

$$\frac{d^2}{dt^2} \left(\frac{\kappa}{\tau}(u(t) + c) \right) - \frac{\kappa}{\tau}(u(t) + c) = 0, \quad (12)$$

where $u(t)$ is a real valued function. (12) has an elementary solution. It follows that

$$\frac{\kappa}{\tau}(u(t) + c) = k_1 e^t + k_2 e^{-t}, \quad (13)$$

where k_1, k_2 are real numbers. Using hyperbolic functions \cosh and \sinh , finally we write that

$$\frac{\kappa}{\tau}(s + c) = A_1 \cosh \int_0^s \sigma ds + A_2 \sinh \int_0^s \sigma ds, \quad (14)$$

where A_1 and A_2 real numbers. Moreover, integrating both sides of (11), we have

$$\left[\frac{\kappa}{\tau}(s + c) \right]^2 - \frac{1}{\sigma^2} \left[\frac{d}{ds} \left(\frac{\kappa}{\tau}(s + c) \right) \right]^2 = \text{constant}. \quad (15)$$

Now, we write following results by means of theorem (2.2) and above equations.

Corollary 3.2 *Let $\xi = \xi(s)$ be an unit speed space-like curve with curvatures $\kappa \neq 0, \tau \neq 0$ and $\sigma \neq 0$ in E_1^4 and second component of position vector of ξ on Frenet axis be zero. Then*

- (i) *there are relations among curvatures of ξ as (11), (14) and (15);*
- (ii) *there are no inclined curves in E_1^4 whose position vector lies fully in TB_1B_2 subspace;*
- (iii) *position vector of ξ can be written as*

$$\xi(s) = (s + c)T - \frac{\kappa}{\tau}(s + c)B_1 + \frac{1}{\sigma} \frac{d}{ds} \left(\frac{\kappa}{\tau}(s + c) \right) B_2. \quad (16)$$

Case 3 Let us suppose $m_3 = 0$ and $\kappa = \text{constant}$. Then, we arrive

$$\left\{ \begin{array}{l} m_1 = \frac{c_4}{\kappa} \frac{d}{ds} \left(\frac{\sigma}{\tau} \right) \\ m_2 = -c_4 \frac{\sigma}{\tau} \\ m_4 = c_4 \end{array} \right\}. \quad (17)$$

Substituting (17)₁ and (17)₂ to (6)₁, we obtain following differential equation respect to $\frac{\sigma}{\tau}$

$$\frac{d^2}{ds^2} \left(\frac{\sigma}{\tau} \right) + \kappa^2 \frac{\sigma}{\tau} = \frac{\kappa}{c_4}. \quad (18)$$

(18) yields that

$$\frac{\sigma}{\tau} = l_1 \cos \kappa s + l_2 \sin \kappa s + \frac{1}{\kappa c_4}. \quad (19)$$

And therefore, we write following results.

Corollary 3.3 *Let $\xi = \xi(s)$ be an unit speed space-like curve with constant first curvature and $\tau \neq 0, \sigma \neq 0$ in E_1^4 and third component of position vector of ξ on Frenet axis be zero. Then*

- (i) *there is a relation among curvatures of ξ as (19);*
- (ii) *position vector of ξ can be written as*

$$\xi(s) = \frac{c_4}{\kappa} \frac{d}{ds} \left(\frac{\sigma}{\tau} \right) T - c_4 \frac{\sigma}{\tau} N + c_4 B_2. \quad (20)$$

Remark 3.4 Due to σ , m_4 can not be zero. Thus, the case $m_4 = \text{constant}$ is similar to case 3.

And finally, considering system of equation (6), we write following characterizations.

Corollary 3.5 *Let $\xi = \xi(s)$ be an unit speed space-like curve with curvatures $\kappa \neq 0, \tau \neq 0$ and $\sigma \neq 0$ in E_1^4 .*

(i) *The components m_1 and m_2 can not be zero, together. This result implies that $\xi = \xi(s)$ never lies fully $B_1 B_2$ hyperplane. Similarly, the components m_2 and m_3 can not be zero, together. This result follows that $\xi = \xi(s)$ never lies fully in $T B_2$ hyperplane.*

(ii) *If the components $m_1 = m_2 = 0$, then, for the space-like curve $\xi = \xi(s)$, there holds $\kappa = \text{constant}$ and $\frac{\sigma}{\tau} = \text{constant}$.*

(iii) *The components m_i , for $1 \leq i \leq 4$, can not be nonzero constants, together.*

Remark 3.6 In the case when $\xi = \xi(s)$ is a space-like curve within other cases or when is a time-like curve, there holds corollaries which are analogous with corollary 3.1, 3.2, 3.3 and 3.5.

References

- [1] B.O'Neill, *Semi-Riemannian Geometry*, Academic Press, New York,1983.
- [2] C.Boyer, *A History of Mathematics*, New York, Wiley,1968.
- [3] C.Camci, K. Ilarslan and E. Sucurovic, On pseudohyperbolic curves in Minkowski space-time. *Turk J.Math.* **27** (2003) 315-328.
- [4] L.F.Mao, Pseudo-manifold geometries with applications, *International J.Math. Combin.*, Vol.1(2007), No.1, 45-58.
- [5] J.Walrave, Curves and surfaces in Minkowski space. Dissertation, K. U. Leuven, Fac. of Science, Leuven,1995.
- [6] S. Yilmaz, Spherical Indicators of Curves and Characterizations of Some Special Curves in four dimensional Lorentzian Space L^4 , Dissertation, Dokuz Eylul University, (2001).

Combinatorially Riemannian Submanifolds

Linfan MAO

(Chinese Academy of Mathematics and System Science, Beijing 100080, P.R.China)

E-mail: maolinfan@163.com

Abstract: Submanifolds are important objectives in classical Riemannian geometry, particularly their embedding or immersion in Euclidean spaces. These similar problems can be also considered for combinatorial manifolds. Several criterions and fundamental equations for characterizing combinatorially Riemannian submanifolds of a combinatorially Riemannian manifold are found, and the isometry embedding of a combinatorially Riemannian manifold in an Euclidean space is considered by a combinatorial manner in this paper.

Key Words: combinatorially Riemannian manifold, combinatorially Riemannian submanifold, criterion, fundamental equation of combinatorially Riemannian submanifolds, embedding in an Euclidean space.

AMS(2000): 51M15, 53B15, 53B40, 57N16, 83C05, 83F05.

§1. Introduction

Combinatorial manifolds were introduced in [9] by a combinatorial speculation on classical *Riemannian* manifolds, also an application of Smarandache multi-spaces in mathematics (see [12] – [13] for details), which can be used both in theoretical physics for generalizing classical spacetimes to multiple one, also enables one to realize those of non-uniform spaces and multilateral properties of objectives.

For a given integer sequence $n_1, n_2, \dots, n_m, m \geq 1$ with $0 < n_1 < n_2 < \dots < n_m$, a *combinatorial manifold* \widetilde{M} is defined to be a *Hausdorff* space such that for any point $p \in \widetilde{M}$, there is a local chart (U_p, φ_p) of p , i.e., an open neighborhood U_p of p in \widetilde{M} and a homoeomorphism

$$\varphi_p : U_p \rightarrow \bigcup_{i=1}^s B_i^{n_i},$$

where $B_1^{n_1}, B_2^{n_2}, \dots, B_s^{n_s}$ are unit balls with $\bigcap_{i=1}^s B_i^{n_i} \neq \emptyset$ and $\{n_1(p), n_2(p), \dots, n_{s(p)}(p)\} \subseteq \{n_1, n_2, \dots, n_m\}$ and $\bigcup_{p \in \widetilde{M}} \{n_1(p), n_2(p), \dots, n_{s(p)}(p)\} = \{n_1, n_2, \dots, n_m\}$. Denoted by $\widetilde{M}(n_1, n_2, \dots, n_m)$ or \widetilde{M} on the context.

Let $\widetilde{\mathcal{A}} = \{(U_p, \varphi_p) | p \in \widetilde{M}(n_1, n_2, \dots, n_m)\}$ be an atlas on $\widetilde{M}(n_1, n_2, \dots, n_m)$. The maximum value of $s(p)$ and the dimension of $\bigcap_{i=1}^{s(p)} B_i^{n_i}$ are called the dimension and the intersec-

¹Received January 6, 2008. Accepted March 25, 2008.

tional dimensional of $\widetilde{M}(n_1, n_2, \dots, n_m)$ at the point p , denoted by $d_{\widetilde{M}}(p)$ and $\widehat{d}_{\widetilde{M}}(p)$, respectively. A combinatorial manifold \widetilde{M} is called *finite* if it is just combined by finite manifolds without one manifold contained in the union of others, called *smooth* if it is finite endowed with a C^∞ differential structure. For a smoothly combinatorial manifold \widetilde{M} and a point $p \in \widetilde{M}$, it has been shown in [7] that $\dim T_p \widetilde{M}(n_1, n_2, \dots, n_m) = \widehat{s}(p) + \sum_{i=1}^{s(p)} (n_i - \widehat{s}(p))$ and $\dim T_p^* \widetilde{M}(n_1, n_2, \dots, n_m) = \widehat{s}(p) + \sum_{i=1}^{s(p)} (n_i - \widehat{s}(p))$ with a basis

$$\left\{ \frac{\partial}{\partial x^{i_0 j}} \Big|_p \mid 1 \leq j \leq \widehat{s}(p) \right\} \cup \left(\bigcup_{i=1}^{s(p)} \left\{ \frac{\partial}{\partial x^{ij}} \Big|_p \mid \widehat{s}(p) + 1 \leq j \leq n_i \right\} \right)$$

or

$$\left\{ dx^{i_0 j} \Big|_p \mid 1 \leq j \leq \widehat{s}(p) \right\} \cup \left(\bigcup_{i=1}^{s(p)} \left\{ dx^{ij} \Big|_p \mid \widehat{s}(p) + 1 \leq j \leq n_i \right\} \right)$$

for any integer $i_0, 1 \leq i_0 \leq s(p)$. Let \widetilde{M} be a smoothly combinatorial manifold and

$$g \in A^2(\widetilde{M}) = \bigcup_{p \in \widetilde{M}} T_2^0(p, \widetilde{M}).$$

If g is symmetrical and positive, then \widetilde{M} is called a combinatorially Riemannian manifold, denoted by (\widetilde{M}, g) . In this case, if there is a connection \widetilde{D} on (\widetilde{M}, g) with equality following hold

$$Z(g(X, Y)) = g(\widetilde{D}_Z, Y) + g(X, \widetilde{D}_Z Y)$$

then \widetilde{M} is called a combinatorially Riemannian geometry, denoted by $(\widetilde{M}, g, \widetilde{D})$. It has been showed that there exists a unique connection \widetilde{D} on (\widetilde{M}, g) such that $(\widetilde{M}, g, \widetilde{D})$ is a combinatorially Riemannian geometry ([7] – [8]).

A subset \widetilde{S} of a combinatorial manifold or a combinatorially Riemannian manifold \widetilde{M} is called a *combinatorial submanifold* or *combinatorially Riemannian submanifold* if it is a combinatorial manifold or a combinatorially Riemannian manifold itself. In classical Riemannian geometry, submanifolds are very important objectives in research, particularly their embedding or immersion in Euclidean spaces. These similar problems should be also considered on combinatorial submanifolds for characterizing combinatorial manifolds, such as those of *what condition ensures a subset of a combinatorial manifold or a combinatorially Riemannian manifold to be a combinatorial submanifold or a combinatorially Riemannian submanifold in topology or in geometry?* Notice that there are no doubts for the existence of submanifolds of a given manifold in classical Riemannian geometry. Thereby one can got various fundamental equations, such as those of the *Gauss's*, the *Codazzi's* and the *Ricci's* for handling the behavior of submanifolds of a Riemannian manifold. But for a combinatorially Riemannian manifold the situation is more complex for it being provided with a combinatorial structure. Therefore, problems without consideration in classical Riemannian geometry should be researched thoroughly in this time. For example, for a given subgraph Γ of $G[\widetilde{M}]$ underlying \widetilde{M} , *whether is*

there a combinatorial submanifold or a combinatorially Riemannian submanifold underlying Γ ? Are those of fundamental equations, i.e., the Gauss's, the Codazzi's or the Ricci's still true for combinatorially Riemannian submanifolds? If not, what are their right forms? All these problems should be answered in this paper.

Now let \widetilde{M} , \widetilde{N} be two combinatorial manifolds, $F : \widetilde{M} \rightarrow \widetilde{N}$ a smooth mapping and $p \in \widetilde{M}$. For $\forall v \in T_p\widetilde{M}$, define a tangent vector $F_*(v) \in T_{F(p)}\widetilde{N}$ by

$$F_*(v) = v(f \circ F), \quad \forall f \in C_{F(p)}^\infty,$$

called the differentiation of F at the point p . Its dual $F^* : T_{F(p)}^*\widetilde{N} \rightarrow T_p^*\widetilde{M}$ determined by

$$(F^*\omega)(v) = \omega(F_*(v)) \text{ for } \forall \omega \in T_{F(p)}^*\widetilde{N} \text{ and } \forall v \in T_p\widetilde{M}$$

is called a *pull-back* mapping. We know that mappings F_* and F^* are linear.

For a smooth mapping $F : \widetilde{M} \rightarrow \widetilde{N}$ and $p \in \widetilde{M}$, if $F_{*p} : T_p\widetilde{M} \rightarrow T_{F(p)}\widetilde{N}$ is one-to-one, we call it an *immersion mapping*. Besides, if F_{*p} is onto and $F : \widetilde{M} \rightarrow F(\widetilde{M})$ is a homoeomorphism with the relative topology of \widetilde{N} , then we call it an *embedding mapping* and (F, \widetilde{M}) a *combinatorially embedded submanifold*. Usually, we replace the mapping F by an inclusion mapping $\tilde{i} : \widetilde{M} \rightarrow \widetilde{N}$ and denoted by $(\tilde{i}, \widetilde{M})$ a combinatorial submanifold of \widetilde{N} .

Terminology and notations used in this paper are standard and can be found in [1] – [2], [14] for manifolds and submanifolds, [3] – [5] for Smarandache multi-spaces and graphs, [7] – [10] for combinatorial manifolds and [11] for topology, respectively.

§2. Topological Criteria

Let $\widetilde{M} = \widetilde{M}(n_1, n_2, \dots, n_m)$, $\widetilde{N} = \widetilde{N}(k_1, k_2, \dots, k_l)$ be two finitely combinatorial manifolds and $F : \widetilde{M} \rightarrow \widetilde{N}$ a smooth mapping. For $\forall p \in \widetilde{M}$, let (U_p, φ_p) and $(V_{F(p)}, \psi_{F(p)})$ be local charts of p in \widetilde{M} and $F(p)$ in \widetilde{N} , respectively. Denoted by

$$J_{X;Y}(F)(p) = \left[\frac{\partial F^{\kappa\lambda}}{\partial x^{\mu\nu}} \right]$$

the *Jacobi matrix* of F at p . Then we find that

Theorem 2.1 *Let $F : \widetilde{M} \rightarrow \widetilde{N}$ be a smooth mapping from \widetilde{M} to \widetilde{N} . Then F is an immersion mapping if and only if*

$$\text{rank}(J_{X;Y}(F)(p)) = d_{\widetilde{M}}(p)$$

for $\forall p \in \widetilde{M}$.

Proof Assume the coordinate matrixes of points $p \in \widetilde{M}$ and $F(p) \in \widetilde{N}$ are $[x^{ij}]_{s(p) \times n_s(p)}$ and $[y^{ij}]_{s(F(p)) \times n_s(F(p))}$, respectively. Notice that

$$T_p\widetilde{M} = \left\langle \frac{\partial}{\partial x^{i_0 j_1}} \Big|_p, \frac{\partial}{\partial x^{i j_2}} \Big|_p \mid 1 \leq i \leq s(p), 1 \leq j_1 \leq \widehat{s}(p), \widehat{s}(p) + 1 \leq j_2 \leq n_i \right\rangle$$

and

$$T_{F(p)}\tilde{N} = \left\langle \left\{ \frac{\partial}{\partial y^{i_0 j_1}} \Big|_{F(p)}, 1 \leq j_1 \leq \widehat{s}(F(p)) \right\} \bigcup_{i=1}^{s(F(p))} \left\{ \frac{\partial}{\partial y^{i j_2}} \Big|_{F(p)}, \widehat{s}(F(p)) + 1 \leq j_2 \leq k_i \right\} \right\rangle$$

for any integer $i_0, 1 \leq i_0 \leq \min\{s(p), s(F(p))\}$. By definition, F_{*p} is a linear mapping. We only need to prove that $F_{*p} : T_p\tilde{M} \rightarrow T_p\tilde{N}$ is an injection for $\forall p \in \tilde{M}$. For $\forall f \in \mathcal{X}_p$, calculation shows that

$$\begin{aligned} F_{*p}\left(\frac{\partial}{\partial x^{ij}}\right)(f) &= \frac{\partial(f \circ F)}{\partial x^{ij}} \\ &= \sum_{\mu, \nu} \frac{\partial F^{\mu\nu}}{\partial x^{ij}} \frac{\partial f}{\partial y^{\mu\nu}}. \end{aligned}$$

Whence, we find that

$$F_{*p}\left(\frac{\partial}{\partial x^{ij}}\right) = \sum_{\mu, \nu} \frac{\partial F^{\mu\nu}}{\partial x^{ij}} \frac{\partial}{\partial y^{\mu\nu}}. \quad (2.1)$$

According to a fundamental result on linear equation systems, these exist solutions in the equation system (2.1) if and only if

$$\text{rank}(J_{X;Y}(F)(p)) = \text{rank}(J_{X;Y}^*(F)(p)),$$

where

$$J_{X;Y}^*(F)(p) = \begin{bmatrix} \cdots & F_{*p}\left(\frac{\partial}{\partial x^{11}}\right) \\ \cdots & \cdots \\ \cdots & F_{*p}\left(\frac{\partial}{\partial x^{1n_1}}\right) \\ J_{X;Y}(F)(p) & \cdots \\ \cdots & F_{*p}\left(\frac{\partial}{\partial x^{s(p)1}}\right) \\ \cdots & \cdots \\ \cdots & F_{*p}\left(\frac{\partial}{\partial x^{s(p)n_{s(p)}}}\right) \end{bmatrix}.$$

We have known that

$$\text{rank}(J_{X;Y}^*(F)(p)) = d_{\tilde{M}}(p).$$

Therefore, F is an immersion mapping if and only if

$$\text{rank}(J_{X;Y}(F)(p)) = d_{\tilde{M}}(p)$$

for $\forall p \in \tilde{M}$. □

For finding some simple criterions for combinatorial submanifolds, we consider the case that $F : \tilde{M} \rightarrow \tilde{N}$ maps each manifold of \tilde{M} to a manifold of \tilde{N} , denoted by $F : \tilde{M} \rightarrow_1 \tilde{N}$, which can be characterized by a purely combinatorial manner. In this case, \tilde{M} is called a *combinatorial in-submanifold of \tilde{N}* .

Let G be a connected graph. A *vertex-edge labeled graph* G^L defined on G is a triple $(G; \tau_1, \tau_2)$, where $\tau_1 : V(G) \rightarrow \{1, 2, \dots, k\}$ and $\tau_2 : E(G) \rightarrow \{1, 2, \dots, l\}$ for positive integers k and l .

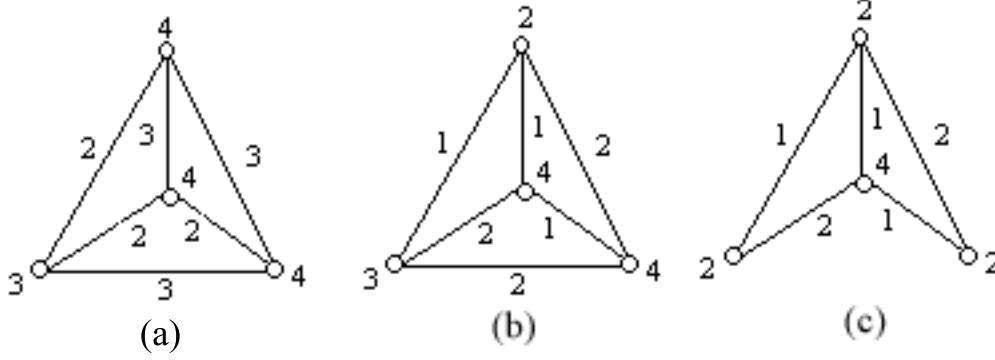

Fig.2.1

For a given vertex-edge labeled graph $G^L = (V^L, E^L)$ on a graph $G = (V, E)$, its a subgraph is defined to be a connected subgraph $\Gamma \prec G$ with labels $\tau_1|_{\Gamma}(u) \leq \tau_1|_G(u)$ for $\forall u \in V(\Gamma)$ and $\tau_2|_{\Gamma}(u, v) \leq \tau_2|_G(u, v)$ for $\forall (u, v) \in E(\Gamma)$, denoted by $\Gamma^L \prec G^L$. For example, two vertex-edge labeled graphs with an underlying graph K_4 are shown in Fig.2.1, in which the vertex-edge labeled graphs (b) and (c) are subgraphs of that (a).

For a finitely combinatorial manifold $\widetilde{M}(n_1, n_2, \dots, n_m)$ with $1 \leq n_1 < n_2 < \dots < n_m, m \geq 1$, we can naturally construct a vertex-edge labeled graph $G^L[\widetilde{M}(n_1, n_2, \dots, n_m)] = (V^L, E^L)$ by defining

$$V^L = \{n_i - \text{manifolds } M^{n_i} \text{ in } \widetilde{M}(n_1, n_2, \dots, n_m) | 1 \leq i \leq m\}$$

with a label $\tau_1(M^{n_i}) = n_i$ for each vertex $M^{n_i}, 1 \leq i \leq m$ and

$$E^L = \{(M^{n_i}, M^{n_j}) | M^{n_i} \cap M^{n_j} \neq \emptyset, 1 \leq i, j \leq m\}$$

with a label $\tau_2(M^{n_i}, M^{n_j}) = \dim(M^{n_i} \cap M^{n_j})$ for each edge $(M^{n_i}, M^{n_j}), 1 \leq i, j \leq m$. This construction then enables us to get a topological criterion for combinatorial submanifolds of a finitely combinatorial manifold by subgraphs in a vertex-edge labeled graph. For this objective, we introduce the *feasibly vertex-edge labeled subgraphs* of $G^L[\widetilde{M}]$ on a finitely combinatorial manifold \widetilde{M} following.

Applying these vertex-edge labeled graphs correspondent to finitely combinatorial manifolds, we get some criterions for combinatorial submanifolds. Firstly, we establish a decomposition result on unit for smoothly combinatorial manifolds.

Lemma 2.1 *Let \widetilde{M} be a smoothly combinatorial manifolds with the second axiom of countability hold. For $\forall p \in \widetilde{M}$, let U_p be the intersection of $\widehat{s}(p)$ manifolds $M_1, M_2, \dots, M_{\widehat{s}(p)}$. Then there are functions $f_{M_i}, 1 \leq i \leq \widehat{s}(p)$ in a local chart $(V_p, [\varphi_p]), V_p \subset U_p$ in \widetilde{M} such that*

$$f_{M_i} = \begin{cases} 1 & \text{on } V_p \cap M_i, \\ 0 & \text{otherwise.} \end{cases}$$

Proof By definition, each manifold M_i is also smooth with the second axiom of countability hold since

$$\mathcal{A}_i = \{(U_p, [\varphi_p])|_{V_p \cap M_i} | p \in M_i\}$$

is a C^∞ differential structure on M_i for any integer $i, 1 \leq i \leq \widehat{s}(p)$. According to the decomposition theorem of unit on manifolds with the second axiom of countability hold, there is a finite cover

$$\Sigma_{M_i} = \{W_\alpha^i, \alpha \in \mathbb{N}\}$$

on each M_i , where \mathbb{N} is a natural number set such that there exists a family function $f_\alpha \in C^\infty(M_i)$ with $f_\alpha|_{W_\alpha^i} \equiv 1$ but $f_\alpha|_{N_i \setminus W_\alpha^i} \equiv 0$.

Not loss of generality, we assume that $p \in W_{\alpha_0}^i$ for any integer i . Let

$$V_p = \bigcap_{i=1}^{\widehat{s}(p)} W_{\alpha_0}^i$$

and define

$$f_{M_i}(q) = \begin{cases} f_{\alpha_0}|_{W_{\alpha_0}^i} & \text{if } q \in W_{\alpha_0}^i, \\ 0 & \text{otherwise.} \end{cases}$$

Then we get these functions $f_{M_i}, 1 \leq i \leq \widehat{s}(p)$ satisfied with our desired. \square

Theorem 2.2 *Let \widetilde{M} be a smoothly combinatorial manifold and N a manifold. If for $\forall M \in V(G[\widetilde{M}])$, there exists an embedding $F_M : M \rightarrow N$, then \widetilde{M} can be embedded into N .*

Proof By assumption, there exists an embedding $F_M : M \rightarrow N$ for $\forall M \in V(G[\widetilde{M}])$. For $p \in \widetilde{M}$, let V_p be the intersection of $\widehat{s}(p)$ manifolds $M_1, M_2, \dots, M_{\widehat{s}(p)}$ with functions $f_{M_i}, 1 \leq i \leq \widehat{s}(p)$ in Lemma 2.1 existed. Define a mapping $\widetilde{F} : \widetilde{M} \rightarrow N$ at p by

$$\widetilde{F}(p) = \sum_{i=1}^{\widehat{s}(p)} f_{M_i} F_{M_i}.$$

Then \widetilde{F} is smooth at each point in \widetilde{M} for the smooth of each F_{M_i} and $\widetilde{F}_{*p} : T_p \widetilde{M} \rightarrow T_p N$ is one-to-one since each $(F_{M_i})_{*p}$ is one-to-one at the point p . Whence, \widetilde{M} can be embedded into the manifold N . \square

Theorem 2.3 *Let \widetilde{M} and \widetilde{N} be smoothly combinatorial manifolds. If for $\forall M \in V(G[\widetilde{M}])$, there exists an embedding $F_M : M \rightarrow \widetilde{N}$, then \widetilde{M} can be embedded into \widetilde{N} .*

Proof Applying Lemma 2.1, we can get a mapping $\widetilde{F} : \widetilde{M} \rightarrow \widetilde{N}$ defined by

$$\tilde{F}(p) = \sum_{i=1}^{\hat{s}(p)} f_{M_i} F_{M_i}$$

at $\forall p \in \tilde{M}$. Similar to the proof of Theorem 2.2, we know that \tilde{F} is smooth and $\tilde{F}_{*p} : T_p \tilde{M} \rightarrow T_p \tilde{N}$ is one-to-one. Whence, \tilde{M} can be embedded into \tilde{N} . \square

Now we introduce conceptions of feasibly vertex-edge labeled subgraphs and labeled quotient graphs in the following.

Definition 2.1 Let \tilde{M} be a finitely combinatorial manifold with an underlying graph $G^L[\tilde{M}]$. For $\forall M \in V(G^L[\tilde{M}])$ and $U^L \subset N_{G^L[\tilde{M}]}(M)$ with new labels $\tau_2(M, M_i) \leq \tau_2|_{G^L[\tilde{M}]}(M, M_i)$ for $\forall M_i \in U^L$, let $J(M_i) = \{M'_i | \dim(M \cap M'_i) = \tau_2(M, M_i), M'_i \subset M_i\}$ and denotes all these distinct representatives of $J(M_i)$, $M_i \in U^L$ by \mathcal{J} . Define the index $o_{\tilde{M}}(M : U^L)$ of M relative to U^L by

$$o_{\tilde{M}}(M : U^L) = \min_{J \in \mathcal{J}} \{ \dim \left(\bigcup_{M' \in J} (M \cap M') \right) \}.$$

A vertex-edge labeled subgraph Γ^L of $G^L[\tilde{M}]$ is feasible if for $\forall u \in V(\Gamma^L)$,

$$\tau_1|_{\Gamma}(u) \geq o_{\tilde{M}}(u : N_{\Gamma^L}(u)).$$

Denoted by $\Gamma^L \prec_o G^L[\tilde{M}]$ a feasibly vertex-edge labeled subgraph Γ^L of $G^L[\tilde{M}]$.

Definition 2.2 Let \tilde{M} be a finitely combinatorial manifold, \mathcal{L} a finite set of manifolds and $F_1^1 : \tilde{M} \rightarrow \mathcal{L}$ an injection such that for $\forall M \in V(G[\tilde{M}])$, there are no two different $N_1, N_2 \in \mathcal{L}$ with $F_1^1(M) \cap N_1 \neq \emptyset$, $F_1^1(M) \cap N_2 \neq \emptyset$ and for different $M_1, M_2 \in V(G[\tilde{M}])$ with $F_1^1(M_1) \subset N_1, F_1^1(M_2) \subset N_2$, there exist $N'_1, N'_2 \in \mathcal{L}$ enabling that $N_1 \cap N'_1 \neq \emptyset$ and $N_2 \cap N'_2 \neq \emptyset$. A vertex-edge labeled quotient graph $G^L[\tilde{M}]/F_1^1$ is defined by

$$V(G^L[\tilde{M}]/F_1^1) = \{N \in \mathcal{L} | \exists M \in V(G[\tilde{M}]) \text{ such that } F_1^1(M) \subset N\},$$

$$E(G^L[\tilde{M}]/F_1^1) = \{(N_1, N_2) | \exists (M_1, M_2) \in E(G[\tilde{M}]), N_1, N_2 \in \mathcal{L} \text{ such that}$$

$$F_1^1(M_1) \subset N_1, F_1^1(M_2) \subset N_2 \text{ and } F_1^1(M_1) \cap F_1^1(M_2) \neq \emptyset\}$$

and labeling each vertex N with $\dim M$ if $F_1^1(M) \subset N$ and each edge (N_1, N_2) with $\dim(M_1 \cap M_2)$ if $F_1^1(M_1) \subset N_1, F_1^1(M_2) \subset N_2$ and $F_1^1(M_1) \cap F_1^1(M_2) \neq \emptyset$.

According to Theorems 2.2 and 2.3, we find criterion for combinatorial submanifolds in the following.

Theorem 2.4 Let \tilde{M} and \tilde{N} be finitely combinatorial manifolds. Then \tilde{M} is a combinatorial in-submanifold of \tilde{N} if and only if there exists an injection F_1^1 on \tilde{M} such that

$$G^L[\tilde{M}]/F_1^1 \prec_o \tilde{N}.$$

Proof If \widetilde{M} is a combinatorial in-submanifold of \widetilde{N} , by definition, we know that there is an injection $F : \widetilde{M} \rightarrow \widetilde{N}$ such that $F(\widetilde{M}) \in V(G[\widetilde{N}])$ for $\forall M \in V(G[\widetilde{M}])$ and there are no two different $N_1, N_2 \in \mathcal{L}$ with $F_1^1(M) \cap N_1 \neq \emptyset$, $F_1^1(M) \cap N_2 \neq \emptyset$. Choose $F_1^1 = F$. Since F is locally 1 – 1 we get that $F(M_1 \cap M_2) = F(M_1) \cap F(M_2)$, i.e., $F(M_1, M_2) \in E(G[\widetilde{N}])$ or $V(G[\widetilde{N}])$ for $\forall (M_1, M_2) \in E(G[\widetilde{M}])$. Whence, $G^L[\widetilde{M}]/F_1^1 \prec G^L[\widetilde{N}]$. Notice that $G^L[\widetilde{M}]$ is correspondent with \widetilde{M} . Whence, it is a feasible vertex-edge labeled subgraph of $G^L[\widetilde{N}]$ by definition. Therefore, $G^L[\widetilde{M}]/F_1^1 \prec_o G^L[\widetilde{N}]$.

Now if there exists an injection F_1^1 on \widetilde{M} , let $\Gamma^L \prec_o G^L[\widetilde{N}]$. Denote by $\overline{\Gamma}$ the graph $G^L[\widetilde{N}] \setminus \Gamma^L$, where $G^L[\widetilde{N}] \setminus \Gamma^L$ denotes the vertex-edge labeled subgraph induced by edges in $G^L[\widetilde{N}] \setminus \Gamma^L$ with non-zero labels in $G[\widetilde{N}]$. We construct a subset \widetilde{M}^* of \widetilde{N} by

$$\widetilde{M}^* = \widetilde{N} \setminus \left(\left(\bigcup_{M' \in V(\overline{\Gamma})} M' \right) \cup \left(\bigcup_{(M', M'') \in E(\overline{\Gamma})} (M' \cap M'') \right) \right)$$

and define $\widetilde{M} = F_1^{1-1}(\widetilde{M}^*)$. Notice that any open subset of an n -manifold is also a manifold and $F_1^{1-1}(\Gamma^L)$ is connected by definition. It can be shown that \widetilde{M} is a finitely combinatorial submanifold of \widetilde{N} with $G^L[\widetilde{M}]/F_1^1 \cong \Gamma^L$. \square

An injection $F_1^1 : \widetilde{M} \rightarrow \mathcal{L}$ is *monotonic* if $N_1 \neq N_2$ if $F_1^1(M_1) \subset N_1$ and $F_1^1(M_2) \subset N_2$ for $\forall M_1, M_2 \in V(G[\widetilde{M}])$, $M_1 \neq M_2$. In this case, we get a criterion for combinatorial submanifolds of a finite combinatorial manifold.

Corollary 2.1 *For two finitely combinatorial manifolds $\widetilde{M}, \widetilde{N}$, \widetilde{M} is a combinatorially monotonic submanifold of \widetilde{N} if and only if $G^L[\widetilde{M}] \prec_o G^L[\widetilde{N}]$.*

Proof Notice that $F_1^1 \equiv \mathbf{1}_1^1$ in the monotonic case. Whence, $G^L[\widetilde{M}]/F_1^1 = G^L[\widetilde{M}]/\mathbf{1}_1^1 = G^L[\widetilde{M}]$. Thereafter, by Theorem 2.4, we know that \widetilde{M} is a combinatorially monotonic submanifold of \widetilde{N} if and only if $G^L[\widetilde{M}] \prec_o G^L[\widetilde{N}]$. \square

§3. Fundamental Formulae

Let $(\widetilde{i}, \widetilde{M})$ be a smoothly combinatorial submanifold of a Riemannian manifold $(\widetilde{N}, g_{\widetilde{N}}, \widetilde{D})$. For $\forall p \in \widetilde{M}$, we can directly decompose the tangent vector space $T_p \widetilde{N}$ into

$$T_p \widetilde{N} = T_p \widetilde{M} \oplus T_p^\perp \widetilde{M}$$

on the Riemannian metric $g_{\widetilde{N}}$ at the point p , i.e., choice the metric of $T_p \widetilde{M}$ and $T_p^\perp \widetilde{M}$ to be $g_{\widetilde{N}}|_{T_p \widetilde{M}}$ or $g_{\widetilde{N}}|_{T_p^\perp \widetilde{M}}$, respectively. Then we get a tangent vector space $T_p \widetilde{M}$ and a orthogonal complement $T_p^\perp \widetilde{M}$ of $T_p \widetilde{M}$ in $T_p \widetilde{N}$, i.e.,

$$T_p^\perp \widetilde{M} = \{v \in T_p \widetilde{N} \mid \langle v, u \rangle = 0 \text{ for } \forall u \in T_p \widetilde{M}\}.$$

We call $T_p \widetilde{M}$, $T_p^\perp \widetilde{M}$ the *tangent space* and *normal space* of $(\widetilde{i}, \widetilde{M})$ at the point p in $(\widetilde{N}, g_{\widetilde{N}}, \widetilde{D})$, respectively. They both have the Riemannian structure, particularly, \widetilde{M} is a combinatorially Riemannian manifold under the induced metric $g = \widetilde{i}^* g_{\widetilde{N}}$.

Therefore, a vector $v \in T_p \widetilde{N}$ can be directly decomposed into

$$v = v^\top + v^\perp,$$

where $v^\top \in T_p \widetilde{M}$, $v^\perp \in T_p^\perp \widetilde{M}$ are the tangent component and the normal component of v at the point p in $(\widetilde{N}, g_{\widetilde{N}}, \widetilde{D})$. All such vectors v^\perp in $T\widetilde{N}$ are denoted by $T^\perp \widetilde{M}$, i.e.,

$$T^\perp \widetilde{M} = \bigcup_{p \in \widetilde{M}} T_p^\perp \widetilde{M}.$$

Whence, for $\forall X, Y \in \mathcal{X}(\widetilde{M})$, we know that

$$\widetilde{D}_X Y = \widetilde{D}_X^\top Y + \widetilde{D}_X^\perp Y,$$

called the *Gauss formula on the combinatorially Riemannian submanifold* (\widetilde{M}, g) , where $\widetilde{D}_X^\top Y = (\widetilde{D}_X Y)^\top$ and $\widetilde{D}_X^\perp Y = (\widetilde{D}_X Y)^\perp$.

Theorem 3.1 *Let $(\widetilde{i}, \widetilde{M})$ be a combinatorially Riemannian submanifold of $(\widetilde{N}, g_{\widetilde{N}}, \widetilde{D})$ with an induced metric $g = \widetilde{i}^* g_{\widetilde{N}}$. Then for $\forall X, Y, Z, \widetilde{D}^\top : \mathcal{X}(\widetilde{M}) \times \mathcal{X}(\widetilde{M}) \rightarrow \mathcal{X}(\widetilde{M})$ determined by $\widetilde{D}^\top(Y, X) = \widetilde{D}_X^\top Y$ is a combinatorially Riemannian connection on (\widetilde{M}, g) and $\widetilde{D}^\perp : \mathcal{X}(\widetilde{M}) \times \mathcal{X}(\widetilde{M}) \rightarrow T^\perp(\widetilde{M})$ is a symmetrically coinvariant tensor field of order 2, i.e.,*

- (1) $\widetilde{D}_{X+Y}^\perp Z = \widetilde{D}_X^\perp Z + \widetilde{D}_Y^\perp Z$;
- (2) $\widetilde{D}_{\lambda X}^\perp Y = \lambda \widetilde{D}_X^\perp Y$ for $\forall \lambda \in C^\infty(\widetilde{M})$;
- (3) $\widetilde{D}_X^\perp Y = \widetilde{D}_Y^\perp X$.

Proof By definition, there exists an inclusion mapping $\widetilde{i} : \widetilde{M} \rightarrow \widetilde{N}$ such that $(\widetilde{i}, \widetilde{M})$ is a combinatorially Riemannian submanifold of $(\widetilde{N}, g_{\widetilde{N}}, \widetilde{D})$ with a metric $g = \widetilde{i}^* g_{\widetilde{N}}$.

For $\forall X, Y, Z \in \mathcal{X}(\widetilde{M})$, we know that

$$\begin{aligned} \widetilde{D}_{X+Y} Z &= \widetilde{D}_X Z + \widetilde{D}_Y Z \\ &= (\widetilde{D}_X^\top Z + \widetilde{D}_X^\perp Z) + (\widetilde{D}_Y^\top Z + \widetilde{D}_Y^\perp Z) \end{aligned}$$

by properties of the combinatorially Riemannian connection \widetilde{D} . Thereby, we find that

$$\widetilde{D}_{X+Y}^\top Z = \widetilde{D}_X^\top Z + \widetilde{D}_Y^\top Z, \quad \widetilde{D}_{X+Y}^\perp Z = \widetilde{D}_X^\perp Z + \widetilde{D}_Y^\perp Z.$$

Similarly, we also find that

$$\widetilde{D}_X^\top(Y+Z) = \widetilde{D}_X^\top Y + \widetilde{D}_X^\top Z, \quad \widetilde{D}_X^\perp(Y+Z) = \widetilde{D}_X^\perp Y + \widetilde{D}_X^\perp Z.$$

Now for $\forall \lambda \in C^\infty(\widetilde{M})$, since

$$\widetilde{D}_{\lambda X} Y = \lambda \widetilde{D}_X Y, \quad \widetilde{D}_X(\lambda Y) = X(\lambda) + \lambda \widetilde{D}_X Y,$$

we find that

$$\widetilde{D}_{\lambda X}^\top Y = \lambda \widetilde{D}_X^\top Y, \quad \widetilde{D}_X^\top(\lambda Y) = X(\lambda) + \lambda \widetilde{D}_X^\top Y$$

and

$$\tilde{D}_X^\perp(\lambda Y) = \lambda \tilde{D}_X^\perp Y.$$

Thereafter, the mapping $\tilde{D}^\top : \mathcal{X}(\tilde{M}) \times \mathcal{X}(\tilde{M}) \rightarrow \mathcal{X}(\tilde{M})$ is a combinatorially connection on (\tilde{M}, g) and $\tilde{D}^\perp : \mathcal{X}(\tilde{M}) \times \mathcal{X}(\tilde{M}) \rightarrow T^\perp(\tilde{M})$ have properties (1) and (2).

By the torsion-free of the Riemannian connection \tilde{D} , i.e.,

$$\tilde{D}_X Y - \tilde{D}_Y X = [X, Y] \in \mathcal{X}(\tilde{M})$$

for $\forall X, Y \in \mathcal{X}(\tilde{M})$, we get that

$$\tilde{D}_X^\top Y - \tilde{D}_Y^\top X = (\tilde{D}_X Y - \tilde{D}_Y X)^\top = [X, Y]$$

and

$$\tilde{D}_X^\perp Y - \tilde{D}_Y^\perp X = (\tilde{D}_X Y - \tilde{D}_Y X)^\perp = 0,$$

i.e., $\tilde{D}_X^\perp Y = \tilde{D}_Y^\perp X$. Whence, \tilde{D}^\top is also torsion-free on (\tilde{M}, g) and the property (3) on \tilde{D}^\perp holds. Applying the compatibility of \tilde{D} with $g_{\tilde{N}}$ in $(\tilde{N}, g_{\tilde{N}}, \tilde{D})$, we finally get that

$$\begin{aligned} Z \langle X, Y \rangle &= \langle \tilde{D}_Z X, Y \rangle + \langle X, \tilde{D}_Z Y \rangle \\ &= \langle \tilde{D}_Z^\top X, Y \rangle + \langle X, \tilde{D}_Z^\top Y \rangle, \end{aligned}$$

which implies that \tilde{D}^\top is also compatible with (\tilde{M}, g) , namely $\tilde{D}^\top : \mathcal{X}(\tilde{M}) \times \mathcal{X}(\tilde{M}) \rightarrow \mathcal{X}(\tilde{M})$ is a combinatorially Riemannian connection on (\tilde{M}, g) . \square

Now for $\forall X \in \mathcal{X}(\tilde{M})$ and $Y^\perp \in T^\perp \tilde{M}$, we know that $\tilde{D}_X Y^\perp \in T\tilde{N}$. Whence, we can directly decompose it into

$$\tilde{D}_X Y^\perp = \tilde{D}_X^\top Y^\perp + \tilde{D}_X^\perp Y^\perp,$$

called the *Weingarten formula on the combinatorially Riemannian submanifold* (\tilde{M}, g) , where $\tilde{D}_X^\top Y^\perp = (\tilde{D}_X Y^\perp)^\top$ and $\tilde{D}_X^\perp Y^\perp = (\tilde{D}_X Y^\perp)^\perp$.

Theorem 3.2 *Let (\tilde{i}, \tilde{M}) be a combinatorially Riemannian submanifold of $(\tilde{N}, g_{\tilde{N}}, \tilde{D})$ with an induced metric $g = \tilde{i}^* g_{\tilde{N}}$. Then the mapping $\tilde{D}^\perp : T^\perp \tilde{M} \times \mathcal{X}(\tilde{M}) \rightarrow T^\perp \tilde{M}$ determined by $\tilde{D}(Y^\perp, X) = \tilde{D}_X^\perp Y^\perp$ is a combinatorially Riemannian connection on $T^\perp \tilde{M}$.*

Proof By definition, we have known that there is an inclusion mapping $\tilde{i} : \tilde{M} \rightarrow \tilde{N}$ such that (\tilde{i}, \tilde{M}) is a combinatorially Riemannian submanifold of $(\tilde{N}, g_{\tilde{N}}, \tilde{D})$ with a metric $g = \tilde{i}^* g_{\tilde{N}}$. For $\forall X, Y \in \mathcal{X}(\tilde{M})$ and $\forall Z^\perp, Z_1^\perp, Z_2^\perp \in T^\perp \tilde{M}$, we know that

$$\tilde{D}_{X+Y}^\perp Z^\perp = \tilde{D}_X^\perp Z^\perp + \tilde{D}_Y^\perp Z^\perp, \quad \tilde{D}_X^\perp (Z_1^\perp + Z_2^\perp) = \tilde{D}_X^\perp Z_1^\perp + \tilde{D}_X^\perp Z_2^\perp$$

similar to the proof of Theorem 3.1. For $\forall \lambda \in C^\infty(\tilde{M})$, we know that

$$\tilde{D}_{\lambda X} Z^\perp = \lambda \tilde{D}_X Z^\perp, \quad \tilde{D}_X(\lambda Z^\perp) = X(\lambda)Z^\perp + \lambda \tilde{D}_X Z^\perp.$$

Whence, we find that

$$\tilde{D}_{\lambda X}^\perp Z^\perp = (\lambda \tilde{D}_X Z^\perp)^\perp = \lambda (\tilde{D}_X Z^\perp)^\perp = \lambda \tilde{D}_X^\perp Z^\perp,$$

$$\tilde{D}_X^\perp(\lambda Z^\perp) = X(\lambda)Z^\perp + \lambda (\tilde{D}_X Z^\perp)^\perp = X(\lambda)Z^\perp + \lambda \tilde{D}_X^\perp Z^\perp.$$

Therefore, the mapping $\tilde{D}^\perp : T^\perp \tilde{M} \times \mathcal{X}(\tilde{M}) \rightarrow T^\perp \tilde{M}$ is a combinatorially connection on $T^\perp \tilde{M}$. Applying the compatibility of \tilde{D} with $g_{\tilde{N}}$ in $(\tilde{N}, g_{\tilde{N}}, \tilde{D})$, we finally get that

$$X \langle Z_1^\perp, Z_2^\perp \rangle = \langle \tilde{D}_X Z_1^\perp, Z_2^\perp \rangle + \langle Z_1^\perp, \tilde{D}_X Z_2^\perp \rangle = \langle \tilde{D}_X^\perp Z_1^\perp, Z_2^\perp \rangle + \langle Z_1^\perp, \tilde{D}_X^\perp Z_2^\perp \rangle,$$

which implies that $\tilde{D}^\perp : \mathcal{X}(\tilde{M}) \times \mathcal{X}(\tilde{M}) \rightarrow \mathcal{X}(\tilde{M})$ is a combinatorially Riemannian connection on $T^\perp \tilde{M}$. \square

Definition 3.1 Let (\tilde{i}, \tilde{M}) be a smoothly combinatorial submanifold of a Riemannian manifold $(\tilde{N}, g_{\tilde{N}}, \tilde{D})$. The two mappings $\tilde{D}^\top, \tilde{D}^\perp$ are called the induced Riemannian connection on \tilde{M} and the normal Riemannian connection on $T^\perp \tilde{M}$, respectively.

Theorem 3.3 Let (\tilde{i}, \tilde{M}) be a combinatorially Riemannian submanifold of $(\tilde{N}, g_{\tilde{N}}, \tilde{D})$ with an induced metric $g = \tilde{i}^* g_{\tilde{N}}$. Then for any chosen $Z^\perp \in T^\perp \tilde{M}$, the mapping $\tilde{D}_{Z^\perp}^\top : \mathcal{X}(\tilde{M}) \rightarrow \mathcal{X}(\tilde{M})$ determined by $\tilde{D}_{Z^\perp}^\top(X) = \tilde{D}_X^\top Z^\perp$ for $\forall X \in \mathcal{X}(\tilde{M})$ is a tensor field of type $(1, 1)$. Besides, if $\tilde{D}_{Z^\perp}^\top$ is treated as a smoothly linear transformation on \tilde{M} , then $\tilde{D}_{Z^\perp}^\top : T_p \tilde{M} \rightarrow T_p \tilde{M}$ at any point $p \in \tilde{M}$ is a self-conjugate transformation on g with the equality following hold

$$\langle \tilde{D}_{Z^\perp}^\top(X), Y \rangle = \langle \tilde{D}_X^\perp(Y), Z^\perp \rangle, \quad \forall X, Y \in T_p \tilde{M}. \quad (*)$$

Proof First, we establish the equality (*). By applying equalities $X \langle Z^\perp, Y \rangle = \langle \tilde{D}_X Z^\perp, Y \rangle + \langle Z^\perp, \tilde{D}_X Y \rangle$ and $\langle Z^\perp, Y \rangle = 0$ for $\forall X, Y \in \mathcal{X}(\tilde{M})$ and $\forall Z^\perp \in T^\perp \tilde{M}$, we find that

$$\begin{aligned} \langle \tilde{D}_{Z^\perp}^\top(X), Y \rangle &= \langle \tilde{D}_X Z^\perp, Y \rangle \\ &= X \langle Z^\perp, Y \rangle - \langle Z^\perp, \tilde{D}_X Y \rangle = \langle \tilde{D}_X^\perp Y, Z^\perp \rangle. \end{aligned}$$

Thereafter, the equality (*) holds.

Now according to Theorem 3.1, $\tilde{D}_X^\perp Y$ possesses tensor properties for $X, Y \in T_p \tilde{M}$. Combining this fact with the equality (*), $\tilde{D}_{Z^\perp}^\top(X)$ is a tensor field of type $(1, 1)$. Whence, $\tilde{D}_{Z^\perp}^\top$ determines a linear transformation $\tilde{D}_{Z^\perp}^\top : T_p \tilde{M} \rightarrow T_p \tilde{M}$ at any point $p \in \tilde{M}$. Besides, we can also show that $\tilde{D}_{Z^\perp}^\top(X)$ possesses the tensor properties for $\forall Z^\perp \in T^\perp \tilde{M}$. For example, for any $\lambda \in C^\infty(\tilde{M})$ we know that

$$\begin{aligned}\langle \tilde{D}_{\lambda Z^\perp}^\top(X), Y \rangle &= \langle \tilde{D}_X^\perp Y, \lambda Z^\perp \rangle = \lambda \langle \tilde{D}_X^\perp Y, Z^\perp \rangle \\ &= \langle \lambda \tilde{D}_{Z^\perp}^\top(X), Y \rangle, \quad \forall X, Y \in \mathcal{X}(\tilde{M})\end{aligned}$$

by applying the equality (*) again. Therefore, we finally get that $\tilde{D}_{\lambda Z^\perp}(X) = \lambda \tilde{D}_{Z^\perp}(X)$.

Combining the symmetry of $\tilde{D}_X^\perp Y$ with the equality (*) enables us to know that the linear transformation $\tilde{D}_{Z^\perp}^\top : T_p \tilde{M} \rightarrow T_p \tilde{M}$ at a point $p \in \tilde{M}$ is self-conjugate. In fact, for $\forall X, Y \in T_p \tilde{M}$, we get that

$$\begin{aligned}\langle \tilde{D}_{Z^\perp}^\top(X), Y \rangle &= \langle \tilde{D}_X^\perp Y, Z^\perp \rangle = \langle \tilde{D}_Y^\perp X, Z^\perp \rangle \\ &= \langle \tilde{D}_{Z^\perp}^\top(Y), X \rangle = \langle X, \tilde{D}_{Z^\perp}^\top(Y) \rangle.\end{aligned}$$

Whence, $\tilde{D}_{Z^\perp}^\top$ is self-conjugate. This completes the proof. \square

Now we look for local forms for \tilde{D}^\top and \tilde{D}^\perp . Let $(\tilde{M}, g, \tilde{D}^\top)$ be a combinatorially Riemannian submanifold of $(\tilde{N}, g_{\tilde{N}}, \tilde{D})$. For $\forall p \in \tilde{M}$, let

$$\begin{aligned}\{e_{AB} | 1 \leq A \leq d_{\tilde{N}}(p), 1 \leq B \leq n_A\} \quad \text{and} \quad e_{A_1 B} = e_{A_2 B}, \\ \text{for} \quad 1 \leq A_1, A_2 \leq d_{\tilde{N}}(p) \text{ if } 1 \leq B \leq \hat{d}_{\tilde{N}}(p)\end{aligned}$$

be an orthogonal frame with a dual

$$\begin{aligned}\{\omega^{AB} | 1 \leq A \leq d_{\tilde{N}}(p), 1 \leq B \leq n_A\} \quad \text{and} \quad \omega^{A_1 B} = \omega^{A_2 B}, \\ \text{for} \quad 1 \leq A_1, A_2 \leq d_{\tilde{N}}(p) \text{ if } 1 \leq B \leq \hat{d}_{\tilde{N}}(p)\end{aligned}$$

at the point p in $T\tilde{N}$ abbreviated to $\{e_{AB}\}$ and ω^{AB} . Choose indexes $(AB), (CD), \dots, (ab), (cd), \dots$ and $(\alpha\beta), (\gamma\delta), \dots$ satisfying $1 \leq A, C \leq d_{\tilde{N}}(p), 1 \leq B \leq n_A, 1 \leq D \leq n_C, \dots, 1 \leq a, c \leq d_{\tilde{M}}(p), 1 \leq b \leq n_a, 1 \leq d \leq n_c, \dots$ and $\alpha, \gamma \geq d_{\tilde{M}}(p) + 1$ or $\beta, \delta \geq n_i + 1$ for $1 \leq i \leq d_{\tilde{M}}(p)$. For getting local forms of \tilde{D}^\top and \tilde{D}^\perp , we can even assume that $\{e_{AB}\}, \{e_{ab}\}$ and $\{e_{\alpha\beta}\}$ are the orthogonal frame of the point in the tangent vector space $T\tilde{N}, T\tilde{M}$ and the normal vector space $T^\perp \tilde{M}$ by Theorems 3.1–3.3. Then the Gauss's and Weingarten's formula can be expressed by

$$\tilde{D}_{e_{ab}} e_{cd} = \tilde{D}_{e_{ab}}^\top e_{cd} + \tilde{D}_{e_{ab}}^\perp e_{cd},$$

$$\tilde{D}_{e_{ab}} e_{\alpha\beta} = \tilde{D}_{e_{ab}}^\top e_{\alpha\beta} + \tilde{D}_{e_{ab}}^\perp e_{\alpha\beta}.$$

When p is varied in \tilde{M} , we know that $\omega^{ab} = \tilde{i}^*(\omega^{ab})$ and $\omega^{\alpha\beta} = 0, \omega^{a\beta} = 0$. Whence, $\{\omega^{ab}\}$ is the dual of $\{e_{ab}\}$ at the point $p \in T\tilde{M}$. Notice that $\tilde{d}\omega^{ab} = \omega^{cd} \wedge \omega_{cd}^{ab}, \omega_{cd}^{ab} + \omega_{ab}^{cd} = 0$ in $(\tilde{M}, g, \tilde{D}^\top)$, $\tilde{d}\omega^{AB} = \omega^{CD} \wedge \omega_{CD}^{AB}, \omega_{AB}^{CD} + \omega_{CD}^{AB} = 0, \omega_{ab}^{\alpha\beta} + \omega_{\alpha\beta}^{ab} = 0, \omega_{\alpha\beta}^{\gamma\delta} + \omega_{\gamma\delta}^{\alpha\beta} = 0$ in $(\tilde{N}, g_{\tilde{N}}, \tilde{D})$ by the structural equations and

$$\tilde{D}e_{AB} = \omega_{AB}^{CD} e_{CD}.$$

We finally get that

$$\tilde{D}e_{ab} = \omega_{ab}^{cd} e_{cd} + \omega_{ab}^{\alpha\beta} e_{\alpha\beta}, \quad \tilde{D}e_{\alpha\beta} = \omega_{\alpha\beta}^{cd} e_{cd} + \omega_{\alpha\beta}^{\gamma\delta} e_{\gamma\delta}.$$

Since $\tilde{d}\omega^{\alpha i} = \omega^{ab} \wedge \omega_{ab}^{\alpha i} = 0$, $\tilde{d}\omega^{i\beta} = \omega^{ab} \wedge \omega_{ab}^{i\beta} = 0$, by the *Cartan's Lemma*, i.e., for vectors $v_1, v_2, \dots, v_r, w_1, w_2, \dots, w_r$ with

$$\sum_{s=1}^r v_s \wedge w_s = 0.$$

if v_1, v_2, \dots, v_r are linearly independent, then

$$w_s = \sum_{t=1}^r a_{st} v_t, \quad 1 \leq s \leq r,$$

where $a_{st} = a_{ts}$, we know that

$$\omega_{ab}^{\alpha i} = h_{(ab)(cd)}^{\alpha i} \omega^{cd}, \quad \omega_{ab}^{i\beta} = h_{(ab)(cd)}^{i\beta} \omega^{cd}$$

with $h_{(ab)(cd)}^{\alpha i} = h_{(ab)(cd)}^{\alpha i}$ and $h_{(ab)(cd)}^{i\beta} = h_{(ab)(cd)}^{i\beta}$. Thereafter, we get that

$$\tilde{D}_{e_{ab}}^\perp e_{cd} = \omega_{ab}^{\alpha\beta} e_{\alpha\beta} = h_{(ab)(cd)}^{\alpha\beta} e_{\alpha\beta},$$

$$\tilde{D}_{e_{ab}}^\top e_{\alpha\beta} = \omega_{\alpha\beta}^{cd} e_{cd} = h_{(ab)(cd)}^{\alpha\beta} e_{\alpha\beta}$$

.

Whence, we get local forms of \tilde{D}^\top and \tilde{D}^\perp in the following.

Theorem 3.4 *Let $(\tilde{M}, g, \tilde{D}^\top)$ be a combinatorially Riemannian submanifold of $(\tilde{N}, g_{\tilde{N}}, \tilde{D})$. For $\forall p \in \tilde{M}$ with locally orthogonal frames $\{e_{AB}\}$, $\{e_{ab}\}$ and their dual $\{\omega^{AB}\}$, $\{\omega^{ab}\}$ in $T\tilde{N}$, $T\tilde{M}$,*

$$\tilde{D}_{e_{ab}}^\top e_{cd} = \omega_{ab}^{cd} e_{cd}, \quad \tilde{D}_{e_{ab}}^\perp e_{cd} = h_{(ab)(cd)}^{\alpha\beta} e_{\alpha\beta}$$

and

$$\tilde{D}_{e_{ab}}^\top e_{\alpha\beta} = h_{(ab)(cd)}^{\alpha\beta} e_{\alpha\beta}, \quad \tilde{D}_{e_{ab}}^\perp e_{\alpha\beta} = \omega_{\alpha\beta}^{\gamma\delta} e_{\gamma\delta}.$$

§4. Fundamental Equations

Applications of these *Gauss's* and *Weingarten's* formulae enable one to get fundamental equations such as the *Gauss's*, *Codazzi's* and *Ricci's* equations on curvature tensors for characterizing combinatorially Riemannian submanifolds.

Theorem 4.1 (Gauss equation) *Let $(\widetilde{M}, g, \widetilde{D}^\top)$ be a combinatorially Riemannian submanifold of $(\widetilde{N}, g_{\widetilde{N}}, \widetilde{D})$ with the induced metric $g = \widetilde{i}^*g_{\widetilde{N}}$ and $\widetilde{R}, \widetilde{R}_{\widetilde{N}}$ curvature tensors on \widetilde{M} and \widetilde{N} , respectively. Then for $\forall X, Y, Z, W \in \mathcal{X}(\widetilde{M})$,*

$$\widetilde{R}(X, Y, Z, W) = \widetilde{R}_{\widetilde{N}}(X, Y, Z, W) + \langle \widetilde{D}_X^\perp Z, \widetilde{D}_Y^\perp W \rangle - \langle \widetilde{D}_Y^\perp Z, \widetilde{D}_X^\perp W \rangle.$$

Proof By definition, we know that

$$\widetilde{\mathcal{R}}_{\widetilde{N}}(X, Y)Z = \widetilde{D}_X \widetilde{D}_Y Z - \widetilde{D}_Y \widetilde{D}_X Z - \widetilde{D}_{[X, Y]}Z.$$

Applying the *Gauss* formula, we find that

$$\begin{aligned} \widetilde{\mathcal{R}}_{\widetilde{N}}(X, Y)Z &= \widetilde{D}_X(\widetilde{D}_Y^\top Z + \widetilde{D}_Y^\perp Z) - \widetilde{D}_Y(\widetilde{D}_X^\top Z + \widetilde{D}_X^\perp Z) \\ &\quad - (\widetilde{D}_{[X, Y]}^\top Z + \widetilde{D}_{[X, Y]}^\perp Z) \\ &= \widetilde{D}_X^\top \widetilde{D}_Y^\top Z + \widetilde{D}_X^\perp \widetilde{D}_Y^\top Z + \widetilde{D}_X \widetilde{D}_Y^\perp Z - \widetilde{D}_Y^\top \widetilde{D}_X^\top Z \\ &\quad - \widetilde{D}_Y^\perp \widetilde{D}_X^\top Z - \widetilde{D}_Y \widetilde{D}_X^\perp Z - \widetilde{D}_{[X, Y]}^\top Z - \widetilde{D}_{[X, Y]}^\perp Z \\ &= \widetilde{R}(X, Y)Z + (\widetilde{D}_X^\perp \widetilde{D}_Y^\top Z - \widetilde{D}_Y^\perp \widetilde{D}_X^\top Z) \\ &\quad - (\widetilde{D}_{[X, Y]}^\perp Z - \widetilde{D}_X \widetilde{D}_Y^\perp Z + \widetilde{D}_Y \widetilde{D}_X^\perp Z). \quad (4.1) \end{aligned}$$

By the *Weingarten* formula,

$$\widetilde{D}_X \widetilde{D}_Y^\perp Z = \widetilde{D}_X^\top \widetilde{D}_Y^\perp Z + \widetilde{D}_X^\perp \widetilde{D}_Y^\perp Z, \quad \widetilde{D}_Y \widetilde{D}_X^\perp Z = \widetilde{D}_Y^\top \widetilde{D}_X^\perp Z + \widetilde{D}_Y^\perp \widetilde{D}_X^\perp Z.$$

Therefore, we get that

$$\langle \widetilde{R}(X, Y)Z, W \rangle = \langle \widetilde{\mathcal{R}}_{\widetilde{N}}(X, Y)Z, W \rangle + \langle \widetilde{D}_X^\perp Z, \widetilde{D}_Y^\perp W \rangle - \langle \widetilde{D}_Y^\perp Z, \widetilde{D}_X^\perp W \rangle$$

by applying the equality (*) in Theorem 2.4, i.e.,

$$\widetilde{R}(X, Y, Z, W) = \widetilde{R}_{\widetilde{N}}(X, Y, Z, W) + \langle \widetilde{D}_X^\perp Z, \widetilde{D}_Y^\perp W \rangle - \langle \widetilde{D}_Y^\perp Z, \widetilde{D}_X^\perp W \rangle. \quad \square$$

For $\forall X, Y, Z \in \mathcal{X}(\widetilde{M})$, define the covariant differential \widetilde{D}_X on $\widetilde{D}_Y^\perp Z$ by

$$(\widetilde{D}_X \widetilde{D}^\perp)_Y Z = \widetilde{D}_X^\perp (\widetilde{D}_Y^\perp Z) - \widetilde{D}_{\widetilde{D}_X^\perp Y}^\perp Z - \widetilde{D}_Y^\perp (\widetilde{D}_X^\top Z).$$

Then we get the *Codazzi equation* in the following.

Theorem 4.2 (Codazzi equation) *Let $(\widetilde{M}, g, \widetilde{D}^\top)$ be a combinatorially Riemannian submanifold of $(\widetilde{N}, g_{\widetilde{N}}, \widetilde{D})$ with the induced metric $g = \widetilde{i}^*g_{\widetilde{N}}$ and $\widetilde{R}, \widetilde{R}_{\widetilde{N}}$ curvature tensors on \widetilde{M} and \widetilde{N} , respectively. Then for $\forall X, Y, Z \in \mathcal{X}(\widetilde{M})$,*

$$(\widetilde{D}_X \widetilde{D}^\perp)_Y Z - (\widetilde{D}_Y \widetilde{D}^\perp)_X Z = \widetilde{R}^\perp(X, Y)Z$$

Proof Decompose the curvature tensor $\widetilde{\mathcal{R}}_{\widetilde{N}}(X, Y)Z$ into

$$\tilde{R}_{\tilde{N}}(X, Y)Z = \tilde{R}_{\tilde{N}}^{\top}(X, Y)Z + \tilde{R}_{\tilde{N}}^{\perp}(X, Y)Z.$$

Notice that

$$\tilde{D}_X^{\top}Y - \tilde{D}_Y^{\top}Z = [X, Y].$$

By the formula (4.1), we know that

$$\begin{aligned} \tilde{R}_{\tilde{N}}^{\perp}(X, Y)Z &= \tilde{D}_X^{\perp}\tilde{D}_Y^{\top}Z - \tilde{D}_Y^{\perp}\tilde{D}_X^{\top}Z - \tilde{D}_{[X, Y]}^{\perp}Z + \tilde{D}_X^{\perp}\tilde{D}_Y^{\perp}Z - \tilde{D}_Y^{\perp}\tilde{D}_X^{\perp}Z \\ &= \tilde{D}_X^{\perp}\tilde{D}_Y^{\perp}Z - \tilde{D}_Y^{\perp}\tilde{D}_X^{\top}Z - \tilde{D}_{\tilde{D}_X^{\top}Y}^{\perp}Z + \tilde{D}_Y^{\perp}\tilde{D}_X^{\perp}Z - \tilde{D}_X^{\perp}\tilde{D}_Y^{\top}Z - \tilde{D}_{\tilde{D}_Y^{\top}X}^{\perp}Z \\ &= (\tilde{D}_X\tilde{D}^{\perp})_Y Z - (\tilde{D}_Y\tilde{D}^{\perp})_X Z. \quad \square \end{aligned}$$

For $\forall X, Y \in \mathcal{X}(\tilde{M})$, $Z^{\perp} \in T^{\perp}(\tilde{M})$, the curvature tensor \tilde{R}^{\perp} determined by \tilde{D}^{\perp} in $T^{\perp}\tilde{M}$ is defined by

$$\tilde{R}^{\perp}(X, Y)Z^{\perp} = \tilde{D}_X^{\perp}\tilde{D}_Y^{\perp}Z^{\perp} - \tilde{D}_Y^{\perp}\tilde{D}_X^{\perp}Z^{\perp} - \tilde{D}_{[X, Y]}^{\perp}Z^{\perp}.$$

Similarly, we get the next result.

Theorem 4.3(Ricci equation) *Let $(\tilde{M}, g, \tilde{D}^{\top})$ be a combinatorially Riemannian submanifold of $(\tilde{N}, g_{\tilde{N}}, \tilde{D})$ with the induced metric $g = \tilde{i}^*g_{\tilde{N}}$ and $\tilde{R}, \tilde{R}_{\tilde{N}}$ curvature tensors on \tilde{M} and \tilde{N} , respectively. Then for $\forall X, Y \in \mathcal{X}(\tilde{M})$, $Z^{\perp} \in T^{\perp}\tilde{M}$,*

$$\tilde{R}^{\perp}(X, Y)Z^{\perp} = \tilde{R}_{\tilde{N}}^{\perp}(X, Y)Z^{\perp} + (\tilde{D}_X\tilde{D}^{\perp})_Y Z^{\perp} - (\tilde{D}_Y\tilde{D}^{\perp})_X Z^{\perp}.$$

Proof Similar to the proof of Theorem 4.1, we know that

$$\begin{aligned} \tilde{R}_{\tilde{N}}(X, Y)Z^{\perp} &= \tilde{D}_X\tilde{D}_Y Z^{\perp} - \tilde{D}_Y\tilde{D}_X Z^{\perp} - \tilde{D}_{[X, Y]}Z^{\perp} \\ &= \tilde{R}^{\perp}(X, Y)Z^{\perp} + \tilde{D}_X^{\perp}\tilde{D}_Y^{\top}Z^{\perp} - \tilde{D}_Y^{\perp}\tilde{D}_X^{\top}Z^{\perp} \\ &\quad + \tilde{D}_X\tilde{D}_Y^{\perp}Z^{\perp} - \tilde{D}_Y\tilde{D}_X^{\perp}Z^{\perp} \\ &= (\tilde{R}^{\perp}(X, Y)Z^{\perp} + (\tilde{D}_X\tilde{D}^{\perp})_Y Z^{\perp} - (\tilde{D}_Y\tilde{D}^{\perp})_X Z^{\perp}) \\ &\quad + \tilde{D}_X^{\top}\tilde{D}_Y^{\perp}Z^{\perp} - \tilde{D}_Y^{\top}\tilde{D}_X^{\perp}Z^{\perp}. \end{aligned}$$

Whence, we get that

$$\tilde{R}^{\perp}(X, Y)Z^{\perp} = \tilde{R}_{\tilde{N}}^{\perp}(X, Y)Z^{\perp} + (\tilde{D}_X\tilde{D}^{\perp})_Y Z^{\perp} - (\tilde{D}_Y\tilde{D}^{\perp})_X Z^{\perp}. \quad \square$$

Certainly, we can also find local forms for these Gauss's, Codazzi's and Ricci's equations in a locally orthogonal frames $\{e_{AB}\}, \{e_{ab}\}$ of $T\tilde{N}$ and $T\tilde{M}$ at a point $p \in \tilde{M}$.

Theorem 4.4 *Let $(\tilde{M}, g, \tilde{D}_{\tilde{M}})$ be a combinatorially Riemannian submanifold of $(\tilde{N}, g_{\tilde{N}}, \tilde{D})$ with $g = \tilde{i}^*g_{\tilde{N}}$ and for $p \in \tilde{M}$, let $\{e_{AB}\}, \{e_{ab}\}$ be locally orthogonal frames of $T\tilde{N}$ and $T\tilde{M}$ at p with dual $\{\omega^{AB}\}, \{\omega^{ab}\}$. Then*

$$\tilde{R}_{(ab)(cd)(ef)(gh)} = (\tilde{R}_{\tilde{N}})_{(ab)(cd)(ef)(gh)} - \sum_{\alpha,\beta} (h_{(ab)(ef)}^{\alpha\beta} h_{(cd)(gh)}^{\alpha\beta} - h_{(ab)(gh)}^{\alpha\beta} h_{(cd)(ef)}^{\alpha\beta}) \quad (Gauss),$$

$$h_{(ab)(cd)(ef)}^{\alpha\beta} - h_{(ab)(ef)(cd)}^{\alpha\beta} = (\tilde{R}_{\tilde{N}})_{(\alpha\beta)(ab)(cd)(ef)} \quad (Codazzi)$$

and

$$\tilde{R}_{(\alpha\beta)(\gamma\delta)(ab)(cd)}^\perp = (\tilde{R}_{\tilde{N}})_{(\alpha\beta)(\gamma\delta)(ab)(cd)} - \sum_{e,f} (h_{(ab)(ef)}^{\alpha\beta} h_{(cd)(gh)}^{\gamma\delta} - h_{(cd)(ef)}^{\alpha\beta\beta} h_{(ab)(gh)}^{\gamma\delta}) \quad (Ricci)$$

with $\tilde{R}_{(\alpha\beta)(\gamma\delta)(ab)(cd)}^\perp = \langle \tilde{R}(e_{ab}, e_{cd})e_{\alpha\beta}, e_{\gamma\delta} \rangle$ and

$$h_{(ab)(cd)(ef)}^{\alpha\beta} \omega^{ef} = \tilde{d}h_{(ab)(cd)}^{\alpha\beta} - \omega_{ab}^{ef} h_{(ef)(cd)}^{\alpha\beta} - \omega_{cd}^{ef} h_{(ab)(ef)}^{\alpha\beta} + \omega_{\gamma\delta}^{\alpha\beta} h_{(ab)(cd)}^{\gamma\delta}.$$

Proof Let $\tilde{\Omega}$ and $\tilde{\Omega}_{\tilde{N}}$ be curvature forms in \tilde{M} and \tilde{N} . Then by the structural equations in $(\tilde{N}, g_{\tilde{N}}, \tilde{D})$ ([10]), we know that

$$(\tilde{\Omega}_{\tilde{N}})_{AB}^{CD} = \tilde{d}\omega_{AB}^{CD} - \omega_{AB}^{EF} \wedge \omega_{EF}^{CD} = \frac{1}{2}(\tilde{R}\tilde{N})_{(AB)(CD)(EF)(GH)} \omega^{EF} \wedge \omega^{GH}$$

and $\tilde{R}(e_{AB}, e_{CD})e_{EF} = \tilde{\Omega}_{EF}^{GH}(e_{AB}, e_{CD})e_{GH}$. Let $\tilde{i} : \tilde{M} \rightarrow \tilde{N}$ be an embedding mapping. Applying \tilde{i}^* action on the above equations, we find that

$$\begin{aligned} (\tilde{\Omega}_{\tilde{N}})_{ab}^{cd} &= \tilde{d}\omega_{ab}^{cd} - \omega_{ab}^{ef} \wedge \omega_{ef}^{cd} - \omega_{ab}^{\alpha\beta} \wedge \omega_{\alpha\beta}^{cd} \\ &= \tilde{\Omega}_{ab}^{cd} + \sum_{\alpha,\beta} h_{(ab)(ef)}^{\alpha\beta} h_{(cd)(gh)}^{\alpha\beta} \omega^{ef} \wedge \omega^{gh}. \end{aligned}$$

Whence, we get that

$$\tilde{\Omega}_{ab}^{cd} = (\tilde{\Omega}_{\tilde{N}})_{ab}^{cd} - \frac{1}{2} \sum_{\alpha,\beta} (h_{(ab)(ef)}^{\alpha\beta} h_{(cd)(gh)}^{\alpha\beta} - h_{(ab)(gh)}^{\alpha\beta} h_{(cd)(ef)}^{\alpha\beta}) \omega^{ef} \wedge \omega^{gh}.$$

This is the *Gauss's* equation

$$\tilde{R}_{(ab)(cd)(ef)(gh)} = (\tilde{R}_{\tilde{N}})_{(ab)(cd)(ef)(gh)} - \sum_{\alpha,\beta} (h_{(ab)(ef)}^{\alpha\beta} h_{(cd)(gh)}^{\alpha\beta} - h_{(ab)(gh)}^{\alpha\beta} h_{(cd)(ef)}^{\alpha\beta}).$$

Similarly, we also know that

$$\begin{aligned} (\tilde{\Omega}_{\tilde{N}})_{ab}^{\alpha\beta} &= \tilde{d}\omega_{ab}^{\alpha\beta} - \omega_{ab}^{cd} \wedge \omega_{cd}^{\alpha\beta} - \omega_{ab}^{\gamma\delta} \wedge \omega_{\gamma\delta}^{\alpha\beta} \\ &= \tilde{d}(h_{(ab)(cd)}^{\alpha\beta} \omega^{cd}) - h_{(cd)(ef)}^{\alpha\beta} \omega_{ab}^{cd} \wedge \omega^{ef} - h_{(ab)(ef)}^{\gamma\delta} \omega^{ef} \wedge \omega_{\gamma\delta}^{\alpha\beta} \\ &= (\tilde{d}h_{(ab)(cd)}^{\alpha\beta} - h_{(ab)(ef)}^{\alpha\beta} \omega_{cd}^{ef}) - h_{(ef)(cd)}^{\alpha\beta} \omega_{ab}^{ef} + h_{(ab)(cd)}^{\gamma\delta} \omega_{\alpha\beta}^{\gamma\delta} \wedge \omega^{cd} \\ &= h_{(ab)(cd)(ef)}^{\alpha\beta} \omega^{ef} \wedge \omega^{cd} \\ &= \frac{1}{2} (h_{(ab)(cd)(ef)}^{\alpha\beta} - h_{(ab)(ef)(cd)}^{\alpha\beta}) \omega^{ef} \wedge \omega^{cd} \end{aligned}$$

and

$$\begin{aligned} (\tilde{\Omega}_{\tilde{N}})_{\alpha\beta}^{\gamma\delta} &= \tilde{d}\omega_{\alpha\beta}^{\gamma\delta} - \omega_{\alpha\beta}^{ef} \wedge \omega_{ef}^{\gamma\delta} - \omega_{\alpha\beta}^{\zeta\eta} \wedge \omega_{\zeta\eta}^{\gamma\delta} \\ &= \tilde{\Omega}_{\alpha\beta}^{\perp\gamma\delta} + \frac{1}{2} \sum_{e,f} (h_{(ef)(ab)}^{\alpha\beta} h_{(ef)(cd)}^{\gamma\delta} - h_{(ef)(cd)}^{\alpha\beta} h_{(ef)(ab)}^{\gamma\delta}) \omega^{ab} \wedge \omega^{cd}. \end{aligned}$$

These equalities enables us to get

$$h_{(ab)(cd)(ef)}^{\alpha\beta} - h_{(ab)(ef)(cd)}^{\alpha\beta} = (\tilde{R}_{\tilde{N}})_{(\alpha\beta)(ab)(cd)(ef)},$$

and

$$\tilde{R}_{(\alpha\beta)(\gamma\delta)(ab)(cd)}^{\perp} = (\tilde{R}_{\tilde{N}})_{(\alpha\beta)(\gamma\delta)(ab)(cd)} - \sum_{e,f} (h_{(ab)(ef)}^{\alpha\beta} h_{(cd)(gh)}^{\gamma\delta} - h_{(cd)(ef)}^{\alpha\beta} h_{(ab)(gh)}^{\gamma\delta}).$$

These are just the *Codazzi's* or *Ricci's* equations. \square

§5. Embedding in Combinatorially Euclidean Spaces

For a given integer sequence $k_1, n_2, \dots, k_l, l \geq 1$ with $0 < k_1 < k_2 < \dots < k_l$, a *combinatorially Euclidean space* $\tilde{\mathbf{R}}(k_1, \dots, k_l)$ is a union of finitely Euclidean spaces $\bigcup_{i=1}^l \mathbf{R}^{k_i}$ such that for $\forall p \in$

$\tilde{\mathbf{R}}(k_1, \dots, k_l)$, $p \in \bigcap_{i=1}^l \mathbf{R}^{k_i}$ with $\hat{l} = \dim(\bigcap_{i=1}^l \mathbf{R}^{k_i})$ a constant. For a given combinatorial manifold $\tilde{M}(n_1, n_2, \dots, n_m)$, wether it can be realized in a combinatorially Euclidean space $\tilde{\mathbf{R}}(k_1, \dots, k_l)$? We consider this problem with twofold in this section, i.e., topological or isometry embedding of a combinatorial manifold in combinatorially Euclidean spaces.

5.1. Topological embedding

Given two topological spaces \mathcal{C}_1 and \mathcal{C}_2 , a *topological embedding* of \mathcal{C}_1 in \mathcal{C}_2 is a one-to-one continuous map

$$f : \mathcal{C}_1 \rightarrow \mathcal{C}_2.$$

When $f : \tilde{M}(n_1, n_2, \dots, n_m) \rightarrow \tilde{\mathbf{R}}(k_1, \dots, k_l)$ maps each manifold of \tilde{M} to an Euclidean space of $\tilde{\mathbf{R}}(k_1, \dots, k_l)$, we say that \tilde{M} is in-embedded into $\tilde{\mathbf{R}}(k_1, \dots, k_l)$.

Whitney had proved once that *any n -manifold can be topological embedded as a closed submanifold of \mathbf{R}^{2n+1} with a sharply minimum dimension $2n + 1$* in 1936^[1]. Applying Whitney's result enables us to find conditions of a finitely combinatorial manifold embedded into a combinatorially Euclidean space $\tilde{\mathbf{R}}(k_1, \dots, k_l)$.

Firstly, We thereafter get a result for the case $l = 1$, which completely answers the problem 4.1 raised in [7].

Theorem 5.1 *Any finitely combinatorial manifold $\tilde{M}(n_1, n_2, \dots, n_m)$ can be embedded into \mathbf{R}^{2n_m+1} .*

Proof According to Whitney's result, each manifold $M^{n_i}, 1 \leq i \leq m$, in $\widetilde{M}(n_1, n_2, \dots, n_m)$ can be topological embedded into an Euclidean space \mathbf{R}^η for any $\eta \geq 2n_i + 1$. By assumption, $n_1 < n_2 < \dots < n_m$. Whence, any manifold in $\widetilde{M}(n_1, n_2, \dots, n_m)$ can be embedded into \mathbf{R}^{2n_m+1} . Applying Theorem 2.2, we know that $\widetilde{M}(n_1, n_2, \dots, n_m)$ can be embedded into \mathbf{R}^{2n_m+1} . \square

For in-embedding a finitely combinatorial manifold $\widetilde{M}(n_1, n_2, \dots, n_m)$ into combinatorially Euclidean spaces $\widetilde{\mathbf{R}}(k_1, \dots, k_l)$, we get the next result.

Theorem 5.2 *Any finitely combinatorial manifold $\widetilde{M}(n_1, n_2, \dots, n_m)$ can be in-embedded into a combinatorially Euclidean space $\widetilde{\mathbf{R}}(k_1, \dots, k_l)$ if there is an injection*

$$\varpi : \{n_1, n_2, \dots, n_m\} \rightarrow \{k_1, k_2, \dots, k_l\}$$

such that

$$\varpi(n_i) \geq \max\{2\epsilon + 1 \mid \forall \epsilon \in \varpi^{-1}(\varpi(n_i))\}$$

and

$$\dim(\mathbf{R}^{\varpi(n_i)} \cap \mathbf{R}^{\varpi(n_j)}) \geq 2\dim(M^{n_i} \cap M^{n_j}) + 1$$

for any integer $i, j, 1 \leq i, j \leq m$ with $M^{n_i} \cap M^{n_j} \neq \emptyset$.

Proof Notice that if

$$\varpi(n_i) \geq \max\{2\epsilon + 1 \mid \forall \epsilon \in \varpi^{-1}(\varpi(n_i))\}$$

for any integer $i, 1 \leq i \leq m$, then each manifold $M^\epsilon, \forall \epsilon \in \varpi^{-1}(\varpi(n_i))$ can be embedded into $\mathbf{R}^{\varpi(n_i)}$ and for $\forall \epsilon_1 \in \varpi^{-1}(n_i), \forall \epsilon_2 \in \varpi^{-1}(n_j), M^{\epsilon_1} \cap M^{\epsilon_2}$ can be in-embedded into $\mathbf{R}^{\varpi(n_i)} \cap \mathbf{R}^{\varpi(n_j)}$ if $M^{\epsilon_1} \cap M^{\epsilon_2} \neq \emptyset$ by Whitney's result. In this case, a few manifolds in $\widetilde{M}(n_1, n_2, \dots, n_m)$ may be in-embedded into one Euclidean space $\mathbf{R}^{\varpi(n_i)}$ for any integer $i, 1 \leq i \leq m$. Therefore, by applying Theorem 2.3 we know that $\widetilde{M}(n_1, n_2, \dots, n_m)$ can be in-embedded into a combinatorially Euclidean space $\widetilde{\mathbf{R}}(k_1, \dots, k_l)$. \square

If $l = 1$ in Theorem 5.2, then we obtain Theorem 5.1 once more since $\varpi(n_i)$ is a constant in this case. But on a classical viewpoint, Theorem 5.1 is more accepted for it presents the appearances of a combinatorial manifold in a classical space. Certainly, we can also get concrete conclusions for practical usefulness by Theorem 5.2, such as the next result.

Corollary 5.1 *Any finitely combinatorial manifold $\widetilde{M}(n_1, n_2, \dots, n_m)$ can be in-embedded into a combinatorially Euclidean space $\widetilde{\mathbf{R}}(k_1, \dots, k_l)$ if*

(i) $l \geq m$;

(ii) there exists m different integers $k_{i_1}, k_{i_2}, \dots, k_{i_m} \in \{k_1, k_2, \dots, k_l\}$ such that

$$k_{i_j} \geq 2n_j + 1$$

and

$$\dim(\mathbf{R}^{k_{i_j}} \cap \mathbf{R}^{k_{i_r}}) \geq 2\dim(M^{n_j} \cap M^{n_r}) + 1$$

for any integer $i, j, 1 \leq i, j \leq m$ with $M^{n_j} \cap M^{n_r} \neq \emptyset$.

Proof Choose an injection

$$\pi : \{n_1, n_2, \dots, n_m\} \rightarrow \{k_1, k_2, \dots, k_l\}$$

by $\pi(n_j) = k_{i_j}$ for $1 \leq j \leq m$. Then conditions (i) and (ii) implies that π is an injection satisfying conditions in Theorem 5.2. Whence, $\widetilde{M}(n_1, n_2, \dots, n_m)$ can be in-embedded into $\widetilde{\mathbf{R}}(k_1, \dots, k_l)$. \square

5.2. Isometry embedding

For two given combinatorially Riemannian C^r -manifolds $(\widetilde{M}, g, \widetilde{D}_{\widetilde{M}})$ and $(\widetilde{N}, g_{\widetilde{N}}, \widetilde{D})$, an *isometry embedding*

$$\widetilde{i} : \widetilde{M} \rightarrow \widetilde{N}$$

is an embedding with $g = \widetilde{i}^* g_{\widetilde{N}}$. By those discussions in Sections 3 and 4, let the local charts of $\widetilde{M}, \widetilde{N}$ be $(U, [x]), (V, [y])$ and the metrics in $\widetilde{M}, \widetilde{N}$ to be respective

$$g_{\widetilde{N}} = \sum_{(\varsigma\tau), (\vartheta\iota)} g_{\widetilde{N}(\varsigma\tau)(\vartheta\iota)} dy^{\varsigma\tau} \otimes dy^{\vartheta\iota}, \quad g = \sum_{(\mu\nu), (\kappa\lambda)} g_{(\mu\nu)(\kappa\lambda)} dx^{\mu\nu} \otimes dx^{\kappa\lambda},$$

then an isometry embedding \widetilde{i} form \widetilde{M} to \widetilde{N} need us to determine wether there are functions

$$y^{\kappa\lambda} = i^{\kappa\lambda}[x^{\mu\nu}], 1 \leq \mu \leq s(p), 1 \leq \nu \leq n_{s(p)}$$

for $\forall p \in \widetilde{M}$ such that

$$\widetilde{R}_{(ab)(cd)(ef)(gh)} = (\widetilde{R}_{\widetilde{N}})_{(ab)(cd)(ef)(gh)} - \sum_{\alpha, \beta} (h_{(ab)(ef)}^{\alpha\beta} h_{(cd)(gh)}^{\alpha\beta} - h_{(ab)(gh)}^{\alpha\beta} h_{(cd)(ef)}^{\alpha\beta}),$$

$$h_{(ab)(cd)(ef)}^{\alpha\beta} - h_{(ab)(ef)(cd)}^{\alpha\beta} = (\widetilde{R}_{\widetilde{N}})_{(\alpha\beta)(ab)(cd)(ef)},$$

$$\widetilde{R}_{(\alpha\beta)(\gamma\delta)(ab)(cd)}^\perp = (\widetilde{R}_{\widetilde{N}})_{(\alpha\beta)(\gamma\delta)(ab)(cd)} - \sum_{e, f} (h_{(ab)(ef)}^{\alpha\beta} h_{(cd)(gh)}^{\gamma\delta} - h_{(cd)(ef)}^{\alpha\beta} h_{(ab)(gh)}^{\gamma\delta})$$

with $\widetilde{R}_{(\alpha\beta)(\gamma\delta)(ab)(cd)}^\perp = \langle \widetilde{R}(e_{ab}, e_{cd})e_{\alpha\beta}, e_{\gamma\delta} \rangle$,

$$h_{(ab)(cd)(ef)}^{\alpha\beta} \omega^{ef} = \widetilde{d}h_{(ab)(cd)}^{\alpha\beta} - \omega_{ab}^{ef} h_{(ef)(cd)}^{\alpha\beta} - \omega_{cd}^{ef} h_{(ab)(ef)}^{\alpha\beta} + \omega_{\gamma\delta}^{\alpha\beta} h_{(ab)(cd)}^{\gamma\delta}$$

and

$$\sum_{(\varsigma\tau),(\vartheta\iota)} g_{\tilde{N}_{(\varsigma\tau)(\vartheta\iota)}}(\tilde{i}[x]) \frac{\partial i^{\varsigma\tau}}{\partial x^{\mu\nu}} \frac{\partial i^{\vartheta\iota}}{\partial x^{\kappa\lambda}} = g_{(\mu\nu)(\kappa\lambda)}[x].$$

For embedding a combinatorial manifold into a combinatorially Euclidean space $\tilde{\mathbf{R}}(k_1, \dots, k_l)$, the last equation can be replaced by

$$\sum_{(\varsigma\tau)} \frac{\partial i^{\varsigma\tau}}{\partial y^{\mu\nu}} \frac{\partial i^{\varsigma\tau}}{\partial y^{\kappa\lambda}} = g_{(\mu\nu)(\kappa\lambda)}[y]$$

since a combinatorially Euclidean space $\tilde{\mathbf{R}}(k_1, \dots, k_l)$ is equivalent to an Euclidean space $\mathbf{R}^{\tilde{k}}$ with a constant $\tilde{k} = \widehat{l}(p) + \sum_{i=1}^{l(p)} (k_i - \widehat{l}(p))$ for $\forall p \in \mathbf{R}^{\tilde{k}}$ but not dependent on p (see [9] for details) and the metric of an Euclidean space $\mathbf{R}^{\tilde{k}}$ to be

$$g_{\tilde{\mathbf{R}}} = \sum_{\mu,\nu} dy^{\mu\nu} \otimes dy^{\mu\nu}.$$

These combined with additional conditions enable us to find necessary and sufficient conditions for existing particular combinatorially Riemannian submanifolds.

Similar to Theorems 5.1 and 5.2, we can also get sufficient conditions on isometry embedding by applying Lemma 2.1, i.e., the decomposition lemma on unit. Firstly, we need two important lemmas following.

Lemma 5.1([2]) *For any integer $n \geq 1$, a Riemannian C^r -manifold of dimensional n with $2 < r \leq \infty$ can be isometry embedded into the Euclidean space $\mathbf{R}^{n^2+10n+3}$.*

Lemma 5.2 *Let $(\widetilde{M}, g, \widetilde{D}_{\widetilde{M}})$ and $(\widetilde{N}, g_{\widetilde{N}}, \widetilde{D})$ be combinatorially Riemannian manifolds. If for $\forall M \in V(G[\widetilde{M}])$, there exists isometry embedding $F_M : M \rightarrow \widetilde{N}$, then \widetilde{M} can be isometry embedded into \widetilde{N} .*

Proof Similar to the proof of Theorems 2.2 and 2.3, we only need to prove that the mapping $\tilde{F} : \widetilde{M} \rightarrow \widetilde{N}$ defined by

$$\tilde{F}(p) = \sum_{i=1}^{\widehat{s}(p)} f_{M_i} F_{M_i}$$

is an isometry embedding. In fact, for $p \in \widetilde{M}$ we have already known that

$$g_{\widetilde{N}}((F_{M_i})_*(v), (F_{M_i})_*(w)) = g(v, w)$$

for $\forall v, w \in T_p \widetilde{M}$ and $i, 1 \leq i \leq \widehat{s}(p)$. By definition we know that

$$\begin{aligned}
g_{\tilde{N}}(\tilde{F}_*(v), \tilde{F}_*(w)) &= g_{\tilde{N}}\left(\sum_{i=1}^{\hat{s}(p)} f_{M_i}(F_{M_i})(v), \sum_{j=1}^{\hat{s}(p)} f_{M_j}(F_{M_j})(w)\right) \\
&= \sum_{i=1}^{\hat{s}(p)} \sum_{j=1}^{\hat{s}(p)} g_{\tilde{N}}(f_{M_i}(F_{M_i})(v), f_{M_j}(F_{M_j})(w)) \\
&= \sum_{i=1}^{\hat{s}(p)} \sum_{j=1}^{\hat{s}(p)} g(f_{M_i}(F_{M_i})(v), f_{M_j}(F_{M_j})(w)) \\
&= g\left(\sum_{i=1}^{\hat{s}(p)} f_{M_i}v, \sum_{j=1}^{\hat{s}(p)} f_{M_j}w\right) \\
&= g(v, w).
\end{aligned}$$

Therefore, \tilde{F} is an isometry embedding. \square

Applying Lemmas 5.1 and 5.2, we get results on isometry embedding of a combinatorial manifolds into combinatorially Euclidean spaces following.

Theorem 5.3 *Any combinatorial Riemannian manifold $\tilde{M}(n_1, n_2, \dots, n_m)$ can be isometry embedded into $\mathbf{R}^{n_m^2 + 10n_m + 3}$.*

Proof According to Lemma 2.1, each manifold M^{n_i} , $1 \leq i \leq m$, in $\tilde{M}(n_1, n_2, \dots, n_m)$ can be isometry embedded into an Euclidean space \mathbf{R}^η for any $\eta \geq n_i^2 + 10n_i + 3$. By assumption, $n_1 < n_2 < \dots < n_m$. Thereafter, each manifold in $\tilde{M}(n_1, n_2, \dots, n_m)$ can be embedded into $\mathbf{R}^{n_m^2 + 10n_m + 3}$. Applying Lemma 5.2, we know that $\tilde{M}(n_1, n_2, \dots, n_m)$ can be isometry embedded into $\mathbf{R}^{n_m^2 + 10n_m + 3}$. \square

Theorem 5.4 *A combinatorially Riemannian manifold $\tilde{M}(n_1, n_2, \dots, n_m)$ can be isometry embedded into a combinatorially Euclidean space $\tilde{\mathbf{R}}(k_1, \dots, k_l)$ if there is an injection*

$$\varpi : \{n_1, n_2, \dots, n_m\} \rightarrow \{k_1, k_2, \dots, k_l\}$$

such that

$$\varpi(n_i) \geq \max\{\epsilon^2 + 10\epsilon + 3 \mid \forall \epsilon \in \varpi^{-1}(\varpi(n_i))\}$$

and

$$\dim(\mathbf{R}^{\varpi(n_i)} \cap \mathbf{R}^{\varpi(n_j)}) \geq \dim(M^{n_i} \cap M^{n_j}) + 10\dim(M^{n_i} \cap M^{n_j}) + 3$$

for any integer $i, j, 1 \leq i, j \leq m$ with $M^{n_i} \cap M^{n_j} \neq \emptyset$.

Proof If

$$\varpi(n_i) \geq \max\{\epsilon^2 + 10\epsilon + 3 \mid \forall \epsilon \in \varpi^{-1}(\varpi(n_i))\}$$

for any integer $i, 1 \leq i \leq m$, then each manifold $M^\epsilon, \forall \epsilon \in \varpi^{-1}(\varpi(n_i))$ can be isometry embedded into $\mathbf{R}^{\varpi(n_i)}$ and for $\forall \epsilon_1 \in \varpi^{-1}(n_i), \forall \epsilon_2 \in \varpi^{-1}(n_j), M^{\epsilon_1} \cap M^{\epsilon_2}$ can be isometry embedded into $\mathbf{R}^{\varpi(n_i)} \cap \mathbf{R}^{\varpi(n_j)}$ if $M^{\epsilon_1} \cap M^{\epsilon_2} \neq \emptyset$ by Lemma 5.1. Notice that in this case, several manifolds in $\widetilde{M}(n_1, n_2, \dots, n_m)$ may be isometry embedded into one Euclidean space $\mathbf{R}^{\varpi(n_i)}$ for any integer $i, 1 \leq i \leq m$. Now applying Lemma 5.2 we know that $\widetilde{M}(n_1, n_2, \dots, n_m)$ can be isometry embedded into a combinatorially Euclidean space $\widetilde{\mathbf{R}}(k_1, \dots, k_l)$. \square

Similar to the proof of Corollary 5.1, we can get a more clearly condition for isometry embedding of combinatorially Riemannian manifolds into combinatorially Euclidean spaces.

Corollary 5.2 *A combinatorially Riemannian manifold $\widetilde{M}(n_1, n_2, \dots, n_m)$ can be isometry embedded into a combinatorially Euclidean space $\widetilde{\mathbf{R}}(k_1, \dots, k_l)$ if*

(i) $l \geq m$;

(ii) *there exists m different integers $k_{i_1}, k_{i_2}, \dots, k_{i_m} \in \{k_1, k_2, \dots, k_l\}$ such that*

$$k_{i_j} \geq n_j^2 + 10n_j + 3$$

and

$$\dim(\mathbf{R}^{k_{i_j}} \cap \mathbf{R}^{k_{i_r}}) \geq \dim^2(M^{n_j} \cap M^{n_r}) + 10\dim(M^{n_j} \cap M^{n_r}) + 3$$

for any integer $i, j, 1 \leq i, j \leq m$ with $M^{n_j} \cap M^{n_r} \neq \emptyset$.

References

- [1] R.Abraham and J.E.Marsden, *Foundation of Mechanics*(2nd edition), Addison-Wesley, Reading, Mass, 1978.
- [2] W.H.Chern and X.X.Li, *Introduction to Riemannian Geometry*(in Chinese), Peking University Press, 2002.
- [3] L.Kuciuk and M.Antholy, An Introduction to Smarandache Geometries, *JP Journal of Geometry and Topology*, 5(1), 2005,77-81.
- [4] L.F.Mao, *Automorphism Groups of Maps, Surfaces and Smarandache Geometries*, American Research Press, 2005.
- [5] L.F.Mao, *Smarandache multi-space theory*, Hexis, Phoenix, AZ2006.
- [6] L.F.Mao, Combinatorial speculation and the combinatorial conjecture for mathematics, *Selected Papers on Mathematical Combinatorics*(I), 1-22, World Academic Union, 2006.
- [7] L.F.Mao, Geometrical theory on combinatorial manifolds, *JP J.Geometry and Topology*, Vol.7, No.1(2007),65-114.
- [8] L.F.Mao, An introduction to Smarandache multi-spaces and mathematical combinatorics, *Scientia Magna*, Vol.3, No.1(2007), 54-80.
- [9] L.F.Mao, A combinatorially generalized Stokes' theorem on integrations, *International J.Mathematical Combinatorics*, Vol.1, No.1(2007), 67-86.
- [10] L.F.Mao, Curvature equations on combinatorial manifolds with applications to theoretical physics, *International J.Mathematical Combinatorics*, Vol.1(2008), No.1, 16-35.

- [11] W.S.Massey, *Algebraic Topology - An Introduction*, Springer-Verlag, New York Inc., 1977.
- [12] F.Smarandache, Mixed noneuclidean geometries, *eprint arXiv: math.GM/0010119*, 10/2000.
- [13] F.Smarandache, A unifying field in logic: neutrosophic field, *Multi-value Logic*, Vol.8, No.3(2002), 385-438.
- [14] J.Stillwell, *Classical Topology and Combinatorial Group Theory*, Springer-Verlag, New York Inc., 1980.
- [15] Chuanxi Wu and Guanghan Li, *Geometry on Submanifolds*(in Chinese), Science Press, Beijing, 2002.

Smarandache Half-Groups

Arun S.Muktibodh

(Mohota Science College, Umred Rd., Nagpur-440009, India.)

E-mail: amukti2000@yahoo.com

Abstract: In this paper we introduce the concept of *half-groups*. This is a totally new concept and demands considerable attention. R.H.Bruck [1] has defined a half groupoid. We have imposed a group structure on a half groupoid wherein we have an identity element and each element has a unique inverse. Further, we have defined a new structure called Smarandache half-group. We have derived some important properties of Smarandache half-groups. Some suitable examples are also given.

Key Words: half-group, subhalf-group, Smarandache half-group, Smarandache subhalf-Group, Smarandache hyper subhalf-group.

AMS(2000): 20Kxx, 20L05.

§1. Introduction

Definition 1.1 Let $(S, *)$ be a half groupoid (a partially closed set with respect to $*$) such that

(1) There exists an element $e \in S$ such that $a * e = e * a = a, \forall a \in S$. e is called identity element of S ;

(2) For every $a \in S$ there exists $b \in S$ such that $a * b = b * a = e$ (identity) b is called the inverse of a .

Then $(S, *)$ is called a half-group.

Remark It is easy to verify that

- (a) identity element in S is unique;
- (b) each element in S has a unique inverse;
- (c) associativity does not hold in S as there is at least one product that is not defined in S .

Note In all composition tables in the following examples the blank entries show that the corresponding products are not defined.

Example 1.1 Let $S = \{1, -i, i\}$. Then S is a half-group w.r.t. multiplication. We write this multiplication table in the following.

¹Received March 2, 2008. Accepted March 28, 2008.

*	1	-i	i
1	1	-i	i
-i	-i		1
i	i	1	

Example 1.2 Let $S = \{e, a, b, c\}$. Then $(S, *)$ is a half subgroup defined by

*	e	a	b	c
e	e	a	b	c
a	a	b	c	e
b	b	c	e	a
c	c	e	a	

Here the product $c * c$ is not defined.

Definition 1.2 Let $(S, *)$ be a half-group and H a subset of S . If H itself is a half-group w.r.t. $*$, then H is called a subhalf-group of S .

Example 1.3 Let $S = \{e, a, b, c, d\}$ be a half-group defined by the following table.

*	e	a	b	c	d
e	e	a	b	c	d
a	a	c	e	b	a
b	b	e	c	a	d
c	c	d	a	e	b
d	d	b	c		e

Then, $H = \{e, a, b\}$ is a subhalf-group of S .

Definition 1.3 A half-group $(S, *)$ is called a Smarandache half-group if S contains a proper subset G such that G is a nontrivial group w.r.t. $*$.

Definition 1.4 If S is Smarandache half-group such that every group contained properly in S is commutative, then S is called Smarandache commutative half-group.

Definition 1.5 If S is a Smarandache half-group such that every group contained properly in S is cyclic, then S is called a Smarandache cyclic half-group.

Example 1.4 Let S be a half-group defined by the following table.

*	e	a	b	c
e	e	a	b	c
a	a	e	c	b
b	b	c	e	a
c	c	e		e

Then $G = \{e, a\}$ is a nontrivial group contained in S . So, S is a Smarandache half-group. Also, $\{e, a, b\}$ is a Smarandache half-group. S is also a Smarandache commutative half-group. Also S is a Smarandache cyclic half-group.

Example 1.5 $S = \{1, -i, i\}$ is not a Smarandache half-group.

Example 1.6 Let L be the Half-Group given by the following table.

*	e	f	g	h	i	j	k	l
e	e	f	g	h	i	j	k	l
f	f	e	j	g	k	h	l	i
g	g	j	e	k	h	l	i	f
h	h	g	k	e	l	i	f	j
i	i	k	h	l	e	f	j	g
j	j	h	l	i	f	e	g	k
k	k	l	i	f	j	g	e	
l	l	i	f	j	g	k		e

Then L is a half-group which contains a group $G = \{e, g\}$. So, L is a Smarandache Half-Group.

There are many Smarandache half-groups in this structure. Results following are obtained immediately by definition

(1) *The smallest half-group is of order 3.*

This follows from the very definition of half-groups.

(2) *The smallest Smarandache half-group is of order 3.*

As a nontrivial group has order at least 2, the half-group which will contain this group properly will have order at least 3.

§2. Substructures of Smarandache Half-Groups

In this section we introduce Smarandache substructure.

Definition 2.1 *Let S be a half-group w.r.t. $*$. A nonempty subset T of S is said to be Smarandache subhalf-group of S if T contains a proper subset G such that G is a nontrivial group under the operation of S .*

Theorem 2.1 *If S is a half-group and T is a Smarandache subhalf-group of S then S is a Smarandache half-group.*

Proof As T is a Smarandache subhalf-group of S , S contains T properly. Also, T properly contains a non trivial group. As a result S is a hlf-group which properly contains a nontrivial group. Therefore S is a Smarandache half-group. \square

We also note facts following on Smarandache half-groups.

(1) If R is a Smarandache half-group then every subhalf-group of R need not be a Smarandache subhalf-group.

We give an example to justify our claim.

Example 2.1 Consider a half-group S defined by the following table.

*	e	f	g	h	i	j
e	e	f	g	h	i	j
f	f	h	e	g	j	i
g	g	e	h	f	i	i
h	h	g	f	e	e	j
i	i	j	i	j	e	
j	j	i	f	i		e

Then $S \supset H = \{e, f, g, h\}$ and H is a group. Therefore S is a Smarandache half-group. Consider a half-group $R = \{e, f, g\}$. Then R is not a Smarandache subhalf-group of S as there does not exist a non trivial group contained in R .

We give a typical example of a half-group following whose subhalf-groups are Smarandache subhalf-group.

Example 2.2 Consider the following table.

*	e	f	g	h	i	j	k	l
e	e	f	g	h	i	j	k	l
f	f	e	j	g	k	h	l	i
g	g	j	e	k	h	l	i	f
h	h	g	k	e	l	i	f	j
i	i	k	h	l	e	f	j	g
j	j	h	l	i	f	e	g	k
k	k	l	i	f	j	g	e	
l	l	i	f	j	g	k		e

One can easily verify that every subhalf-group is a Smarandache subhalf-group.

Definition 2.2 *If S is a Smarandache half-group such that a subhalf-group A of S contains the largest group in S then A is called a Smarandache hyper subhalf-group.*

In the example above, the largest non-trivial group in S is of order 2 and every Smarandache subhalf-Group of S contains the largest group in S . Thus, every Smarandache subhalf-Group in S is a Smarandache hyper subhalf-Group.

References

- [1] R.H.Bruck , *A survey of Binary Systems*, Springer Verlag,(1958).
- [2] W.B.Kandasamy, Smarandache nonassociative rings, *Smarandache Notions Journal*, Vol.14, p.281, (2004).
- [3] R. Padilla, Smarandache Algebraic Structures, *Bulletin of Pure and Applied Sciences*, Delhi, Vol.17 E. No.1, 119-121, (1998).

On Smarandache Bryant Schneider Group of A Smarandache Loop

Tèmítópé Gbóláhàn Jáíyéolá

(Department of Mathematics of Obafemi Awolowo University, Ile Ife, Nigeria.)

E-mail: tjayeola@oauife.edu.ng

Abstract: The concept of Smarandache Bryant Schneider Group of a Smarandache loop is introduced. Relationship(s) between the Bryant Schneider Group and the Smarandache Bryant Schneider Group of an S-loop are discovered and the later is found to be useful in finding Smarandache isotopy-isomorphy condition(s) in S-loops just like the formal is useful in finding isotopy-isomorphy condition(s) in loops. Some properties of the Bryant Schneider Group of a loop are shown to be true for the Smarandache Bryant Schneider Group of a Smarandache loop. Some interesting and useful cardinality formulas are also established for a type of finite Smarandache loop.

Key Words: Smarandache Bryant Schneider group, Smarandache loops, Smarandache f , g -principal isotopes.

AMS(2000): 20NO5, 08A05.

§1. Introduction

The study of Smarandache loops was initiated by W. B. Vasantha Kandasamy in 2002. In her book [16], she defined a Smarandache loop (S-loop) as a loop with at least a subloop which forms a subgroup under the binary operation of the loop. For more on loops and their properties, readers should check [14], [3], [5], [7], [6] and [16]. In her book, she introduced over 75 Smarandache concepts in loops but the concept Smarandache Bryant Schneider Group which is to be studied here for the first time is not among. In her first paper [17], she introduced some types of Smarandache loops. The present author has contributed to the study of S-quasigroups and S-loops in [9], [10] and [11] while Muktibodh [13] did a study on the first.

Robinson [15] introduced the idea of Bryant-Schneider group of a loop because its importance and motivation stem from the work of Bryant and Schneider [4]. Since the advent of the Bryant-Schneider group, some studies by Adeniran [1], [2] and Chiboka [6] have been done on it relative to CC-loops, C-loops and extra loops after Robinson [15] studied the Bryant-Schneider group of a Bol loop. The judicious use of it was earlier predicted by Robinson [15]. As mentioned in [Section 5, Robinson [15]], the Bryant-Schneider group of a loop is extremely useful in investigating isotopy-isomorphy condition(s) in loops.

In this study, the concept of Smarandache Bryant Schneider Group of a Smarandache

¹Received March 6, 2008. Accepted April 2, 2008.

loop is introduced. Relationship(s) between the Bryant Schneider Group and the Smarandache Bryant Schneider Group of an S-loop are discovered and the later is found to be useful in finding Smarandache isotopy-isomorphy condition(s) in S-loops just like the formal is useful in finding isotopy-isomorphy condition(s) in loops. Some properties of the Bryant Schneider Group of a loop are shown to be true for the Smarandache Bryant Schneider Group of a Smarandache loop. Some interesting and useful cardinality formulas are also established for a type of finite Smarandache loop. But first, we state some important definitions.

§2. Definitions and Notations

Definition 2.1 *Let L be a non-empty set. Define a binary operation (\cdot) on L : If $x \cdot y \in L$ for $\forall x, y \in L$, (L, \cdot) is called a groupoid. If the system of equations ; $a \cdot x = b$ and $y \cdot a = b$ have unique solutions for x and y respectively, then (L, \cdot) is called a quasigroup. Furthermore, if there exists a unique element $e \in L$ called the identity element such that for $\forall x \in L$, $x \cdot e = e \cdot x = x$, (L, \cdot) is called a loop.*

Furthermore, if there exist at least a non-empty subset M of L such that (M, \cdot) is a non-trivial subgroup of (L, \cdot) , then L is called a Smarandache loop(S-loop) with Smarandache subgroup(S-subgroup) M .

The set $SYM(L, \cdot) = SYM(L)$ of all bijections in a loop (L, \cdot) forms a group called the permutation(symmetric) group of the loop (L, \cdot) . The triple (U, V, W) such that $U, V, W \in SYM(L, \cdot)$ is called an autotopism of L if and only if $xU \cdot yV = (x \cdot y)W \forall x, y \in L$. The group of autotopisms(under componentwise multiplication [14]) of L is denoted by $AUT(L, \cdot)$. If $U = V = W$, then the group $AUM(L, \cdot) = AUM(L)$ formed by such U 's is called the automorphism group of (L, \cdot) . If L is an S-loop with an arbitrary S-subgroup H , then the group $SSYM(L, \cdot) = SSYM(L)$ formed by all $\theta \in SYM(L)$ such that $h\theta \in H \forall h \in H$ is called the Smarandache permutation(symmetric) group of L . Hence, the group $SA(L, \cdot) = SA(L)$ formed by all $\theta \in SSYM(L) \cap AUM(L)$ is called the *Smarandache automorphism group* of L .

Let (G, \cdot) be a loop. The bijection $L_x : G \longrightarrow G$ defined as $yL_x = x \cdot y, \forall x, y \in G$ is called a left translation(multiplication) of G while the bijection $R_x : G \longrightarrow G$ defined as $yR_x = y \cdot x, \forall x, y \in G$ is called a right translation(multiplication) of G .

Definition 2.2(Robinson [15]) *Let (G, \cdot) be a loop. A mapping $\theta \in SYM(G, \cdot)$ is a special map for G means that there exist $f, g \in G$ so that $(\theta R_g^{-1}, \theta L_f^{-1}, \theta) \in AUT(G, \cdot)$.*

Definition 2.3 *Let (G, \cdot) be a Smarandache loop with S-subgroup (H, \cdot) . A mapping $\theta \in SSYM(G, \cdot)$ is a Smarandache special map(S-special map) for G if and only if there exist $f, g \in H$ such that $(\theta R_g^{-1}, \theta L_f^{-1}, \theta) \in AUT(G, \cdot)$.*

Definition 2.4(Robinson [15]) *Let the set*

$$BS(G, \cdot) = \{\theta \in SYM(G, \cdot) : \exists f, g \in G \ni (\theta R_g^{-1}, \theta L_f^{-1}, \theta) \in AUT(G, \cdot)\}$$

i.e the set of all special maps in a loop, then $BS(G, \cdot) \leq SYM(G, \cdot)$ is called the Bryant-Schneider group of the loop (G, \cdot) .

Definition 2.5 Let the set

$$SBS(G, \cdot) = \{\theta \in SSYM(G, \cdot) : \text{there exist } f, g \in H \ni (\theta R_g^{-1}, \theta L_f^{-1}, \theta) \in AUT(G, \cdot)\}$$

i.e the set of all S -special maps in a S -loop, then $SBS(G, \cdot)$ is called the Smarandache Bryant-Schneider group (SBS group) of the S -loop (G, \cdot) with S -subgroup H if $SBS(G, \cdot) \leq SYM(G, \cdot)$.

Definition 2.6 The triple $\phi = (R_g, L_f, I)$ is called an f, g -principal isotopism of a loop (G, \cdot) onto a loop (G, \circ) if and only if

$$x \cdot y = xR_g \circ yL_f, \forall x, y \in G \text{ or } x \circ y = xR_g^{-1} \cdot yL_f^{-1}, \forall x, y \in G.$$

f and g are called translation elements of G or at times written in the pair form (g, f) , while (G, \circ) is called an f, g -principal isotope of (G, \cdot) .

On the other hand, (G, \otimes) is called a Smarandache f, g -principal isotope of (G, \oplus) if for some $f, g \in S$,

$$xR_g \otimes yL_f = (x \oplus y) \forall x, y \in G$$

where (S, \oplus) is a S -subgroup of (G, \oplus) . In these cases, f and g are called Smarandache elements (S -elements).

Let (L, \cdot) and (G, \circ) be S -loops with S -subgroups L' and G' respectively such that $xA \in G', \forall x \in L'$, where $A : (L, \cdot) \rightarrow (G, \circ)$. Then the mapping A is called a Smarandache isomorphism if $(L, \cdot) \cong (G, \circ)$, hence we write $(L, \cdot) \simeq (G, \circ)$. An S -loop (L, \cdot) is called a G -Smarandache loop (GS -loop) if and only if $(L, \cdot) \simeq (G, \circ)$ for all S -loop isotopes (G, \circ) of (L, \cdot) .

Definition 2.7 Let (G, \cdot) be a Smarandache loop with an S -subgroup H .

$$\Omega(G, \cdot) = \left\{ (\theta R_g^{-1}, \theta L_f^{-1}, \theta) \in AUT(G, \cdot) \text{ for some } f, g \in H : h\theta \in H, \forall h \in H \right\}.$$

§3. Main Results

3.1 Smarandache Bryant Schneider Group

Theorem 3.1 Let (G, \cdot) be a Smarandache loop. $SBS(G, \cdot) \leq BS(G, \cdot)$.

Proof Let (G, \cdot) be an S -loop with S -subgroup H . Comparing Definitions 2.4 and 2.5, it can easily be observed that $SBS(G, \cdot) \subset BS(G, \cdot)$. The case $SBS(G, \cdot) \subseteq BS(G, \cdot)$ is possible when $G = H$ where H is the S -subgroup of G but this will be a contradiction since G is an S -loop.

Identity. If I is the identity mapping on G , then $hI = h \in H, \forall h \in H$ and there exists $e \in H$ where e is the identity element in G such that $(IR_e^{-1}, IL_e^{-1}, I) = (I, I, I) \in AUT(G, \cdot)$. So, $I \in SBS(G, \cdot)$. Thus $SBS(G, \cdot)$ is non-empty.

Closure and Inverse. Let $\alpha, \beta \in SBS(G, \cdot)$. Then there exist $f_1, g_1, f_2, g_2 \in H$ such that

$$A = (\alpha R_{g_1}^{-1}, \alpha L_{f_1}^{-1}, \alpha), B = (\beta R_{g_2}^{-1}, \beta L_{f_2}^{-1}, \beta) \in AUT(G, \cdot).$$

$$AB^{-1} = (\alpha R_{g_1}^{-1}, \alpha L_{f_1}^{-1}, \alpha)(R_{g_2} \beta^{-1}, L_{f_2} \beta^{-1}, \beta^{-1})$$

$$= (\alpha R_{g_1}^{-1} R_{g_2} \beta^{-1}, \alpha L_{f_1}^{-1} L_{f_2} \beta^{-1}, \alpha \beta^{-1}) \in AUT(G, \cdot).$$

Let $\delta = \beta R_{g_1}^{-1} R_{g_2} \beta^{-1}$ and $\gamma = \beta L_{f_1}^{-1} L_{f_2} \beta^{-1}$. Then,

$$(\alpha \beta^{-1} \delta, \alpha \beta^{-1} \gamma, \alpha \beta^{-1}) \in AUT(G, \cdot) \Leftrightarrow (x \alpha \beta^{-1} \delta) \cdot (y \alpha \beta^{-1} \gamma) = (x \cdot y) \alpha \beta^{-1} \quad \forall x, y \in G.$$

Putting $y = e$ and replacing x by $x \beta \alpha^{-1}$, we have $(x \delta) \cdot (e \alpha \beta^{-1} \gamma) = x$ for all $x \in G$. Similarly, putting $x = e$ and replacing y by $y \beta \alpha^{-1}$, we have $(e \alpha \beta^{-1} \delta) \cdot (y \gamma) = y$ for all $y \in G$. Thence, $x \delta R_{(e \alpha \beta^{-1} \gamma)} = x$ and $y \gamma L_{(e \alpha \beta^{-1} \delta)} = y$ which implies that

$$\delta = R_{(e \alpha \beta^{-1} \gamma)}^{-1} \quad \text{and} \quad \gamma = L_{(e \alpha \beta^{-1} \delta)}^{-1}.$$

Thus, since $g = e \alpha \beta^{-1} \gamma$, $f = e \alpha \beta^{-1} \delta \in H$ then

$$AB^{-1} = (\alpha \beta^{-1} R_g^{-1}, \alpha \beta^{-1} L_f^{-1}, \alpha \beta^{-1}) \in AUT(G, \cdot) \Leftrightarrow \alpha \beta^{-1} \in SBS(G, \cdot).$$

Therefore, $SBS(G, \cdot) \leq BS(G, \cdot)$. □

Corollary 3.1 *Let (G, \cdot) be a Smarandache loop. Then, $SBS(G, \cdot) \leq SSYM(G, \cdot) \leq SYM(G, \cdot)$. Hence, $SBS(G, \cdot)$ is the Smarandache Bryant-Schneider group (SBS group) of the S-loop (G, \cdot) .*

Proof Although the fact that $SBS(G, \cdot) \leq SYM(G, \cdot)$ follows from Theorem 3.1 and the fact in [Theorem 1, [15]] that $BS(G, \cdot) \leq SYM(G, \cdot)$. Nevertheless, it can also be traced from the facts that $SBS(G, \cdot) \leq SSYM(G, \cdot)$ and $SSYM(G, \cdot) \leq SYM(G, \cdot)$.

It is easy to see that $SSYM(G, \cdot) \subset SYM(G, \cdot)$ and that $SBS(G, \cdot) \subset SSYM(G, \cdot)$ while the trivial cases $SSYM(G, \cdot) \subseteq SYM(G, \cdot)$ and $SBS(G, \cdot) \subseteq SSYM(G, \cdot)$ will contradict the fact that G is an S-loop because these two are possible if the S-subgroup H is G . Reasoning through the axioms of a group, it is easy to show that $SSYM(G, \cdot) \leq SYM(G, \cdot)$. By using the same steps in Theorem 3.1, it will be seen that $SBS(G, \cdot) \leq SSYM(G, \cdot)$. □

3.2 The SBS Group of a Smarandache f, g -principal isotope

Theorem 3.2 *Let (G, \cdot) be a S-loop with a Smarandache f, g -principal isotope (G, \circ) . Then, (G, \circ) is an S-loop.*

Proof Let (G, \cdot) be an S-loop, then there exist an S-subgroup (H, \cdot) of G . If (G, \circ) is a Smarandache f, g -principal isotope of (G, \cdot) , then

$$x \cdot y = x R_g \circ y L_f, \quad \forall x, y \in G \quad \text{which implies} \quad x \circ y = x R_g^{-1} \cdot y L_f^{-1}, \quad \forall x, y \in G$$

where $f, g \in H$. So

$$h_1 \circ h_2 = h_1 R_g^{-1} \cdot h_2 L_f^{-1}, \forall h_1, h_2 \in H \text{ for some } f, g \in H.$$

Let us now consider the set H under the operation "o". That is the pair (H, \circ) .

Groupoid. Since $f, g \in H$, then by the definition $h_1 \circ h_2 = h_1 R_g^{-1} \cdot h_2 L_f^{-1}$, $h_1 \circ h_2 \in H, \forall h_1, h_2 \in H$ since (H, \cdot) is a groupoid. Thus, (H, \circ) is a groupoid.

Quasigroup. With the definition $h_1 \circ h_2 = h_1 R_g^{-1} \cdot h_2 L_f^{-1}, \forall h_1, h_2 \in H$, it is clear that (H, \circ) is a quasigroup since (H, \cdot) is a quasigroup.

Loop. It can easily be seen that $f \cdot g$ is an identity element in (H, \circ) . So, (H, \circ) is a loop.

Group. Since (H, \cdot) is associative, it is easy to show that (H, \circ) is associative.

Hence, (H, \circ) is an S-subgroup in (G, \circ) since the latter is a loop (a quasigroup with identity element $f \cdot g$). Therefore, (G, \circ) is an S-loop. \square

Theorem 3.3 *Let (G, \cdot) be a Smarandache loop with an S-subgroup (H, \cdot) . A mapping $\theta \in SYM(G, \cdot)$ is a S-special map if and only if θ is an S-isomorphism of (G, \cdot) onto some Smarandache f, g -principal isotopes (G, \circ) where $f, g \in H$.*

Proof By Definition 2.3, a mapping $\theta \in SSYM(G)$ is a S-special map implies there exist $f, g \in H$ such that $(\theta R_g^{-1}, \theta L_f^{-1}, \theta) \in AUT(G, \cdot)$. It can be observed that

$$(\theta R_g^{-1}, \theta L_f^{-1}, \theta) = (\theta, \theta, \theta)(R_g^{-1}, L_f^{-1}, I) \in AUT(G, \cdot).$$

But since $(R_g^{-1}, L_f^{-1}, I) : (G, \circ) \longrightarrow (G, \cdot)$ then for $(\theta R_g^{-1}, \theta L_f^{-1}, \theta) \in AUT(G, \cdot)$ we must have $(\theta, \theta, \theta) : (G, \cdot) \longrightarrow (G, \circ)$ which means $(G, \cdot) \cong_{\theta} (G, \circ)$, hence $(G, \cdot) \simeq_{\theta} (G, \circ)$ because $(H, \cdot)\theta = (H, \circ)$. $(R_g, L_f, I) : (G, \cdot) \longrightarrow (G, \circ)$ is an f, g -principal isotopism so (G, \circ) is a Smarandache f, g -principal isotope of (G, \cdot) by Theorem 3.2.

Conversely, if θ is an S-isomorphism of (G, \cdot) onto some Smarandache f, g -principal isotopes (G, \circ) where $f, g \in H$ such that (H, \cdot) is a S-subgroup of (G, \cdot) means $(\theta, \theta, \theta) : (G, \cdot) \longrightarrow (G, \circ)$, $(R_g, L_f, I) : (G, \cdot) \longrightarrow (G, \circ)$ which implies $(R_g^{-1}, L_f^{-1}, I) : (G, \circ) \longrightarrow (G, \cdot)$ and $(H, \cdot)\theta = (H, \circ)$. Thus, $(\theta R_g^{-1}, \theta L_f^{-1}, \theta) \in AUT(G, \cdot)$. Therefore, θ is a S-special map because $f, g \in H$. \square

Corollary 3.2 *Let (G, \cdot) be a Smarandache loop with an S-subgroup (H, \cdot) . A mapping $\theta \in SBS(G, \cdot)$ if and only if θ is an S-isomorphism of (G, \cdot) onto some Smarandache f, g -principal isotopes (G, \circ) such that $f, g \in H$ where (H, \cdot) is an S-subgroup of (G, \cdot) .*

Proof This follows from Definition 2.5 and Theorem 3.3. \square

Theorem 3.4 *Let (G, \cdot) and (G, \circ) be S-loops. (G, \circ) is a Smarandache f, g -principal isotope of (G, \cdot) if and only if (G, \cdot) is a Smarandache g, f -principal isotope of (G, \circ) .*

Proof Let (G, \cdot) and (G, \circ) be S-loops such that if (H, \cdot) is an S-subgroup in (G, \cdot) , then (H, \circ) is an S-subgroup of (G, \circ) . The left and right translation maps relative to an element x

in (G, \circ) shall be denoted by \mathcal{L}_x and \mathcal{R}_x respectively.

If (G, \circ) is a Smarandache f, g -principal isotope of (G, \cdot) then, $x \cdot y = xR_g \circ yL_f, \forall x, y \in G$ for some $f, g \in H$. Thus, $xR_y = xR_g \mathcal{R}_{yL_f}$ and $yL_x = yL_f \mathcal{L}_{xR_g}, x, y \in G$ and we have $R_y = R_g \mathcal{R}_{yL_f}$ and $L_x = L_f \mathcal{L}_{xR_g}, x, y \in G$. So, $\mathcal{R}_y = R_g^{-1} R_{yL_f^{-1}}$ and $\mathcal{L}_x = L_f^{-1} L_{xR_g^{-1}} = x, y \in G$. Putting $y = f$ and $x = g$ respectively, we now get $\mathcal{R}_f = R_g^{-1} R_{fL_f^{-1}} = R_g^{-1}$ and $\mathcal{L}_g = L_f^{-1} L_{gR_g^{-1}} = L_f^{-1}$. That is, $\mathcal{R}_f = R_g^{-1}$ and $\mathcal{L}_g = L_f^{-1}$ for some $f, g \in H$.

Recall that

$$x \cdot y = xR_g \circ yL_f, \forall x, y \in G \Leftrightarrow x \circ y = xR_g^{-1} \cdot yL_f^{-1}, \forall x, y \in G.$$

So using the last two translation equations,

$$x \circ y = x\mathcal{R}_f \cdot y\mathcal{L}_g, \forall x, y \in G \Leftrightarrow \text{the triple } (\mathcal{R}_f, \mathcal{L}_g, I) : (G, \circ) \longrightarrow (G, \cdot)$$

is a Smarandache g, f -principal isotopism. Therefore, (G, \cdot) is a Smarandache g, f -principal isotope of (G, \circ) .

The converse is achieved by doing the reverse of the procedure described above. \square

Theorem 3.5 *If (G, \cdot) is an S-loop with a Smarandache f, g -principal isotope (G, \circ) , then $SBS(G, \cdot) = SBS(G, \circ)$.*

Proof Let (G, \circ) be the Smarandache f, g -principal isotope of the S-loop (G, \cdot) with S-subgroup (H, \cdot) . By Theorem 3.2, (G, \circ) is an S-loop with S-subgroup (H, \circ) . The left and right translation maps relative to an element x in (G, \circ) shall be denoted by \mathcal{L}_x and \mathcal{R}_x respectively.

Let $\alpha \in SBS(G, \cdot)$, then there exist $f_1, g_1 \in H$ so that $(\alpha R_{g_1}^{-1}, \alpha L_{f_1}^{-1}, \alpha) \in AUT(G, \cdot)$. Recall that the triple $(R_{g_1}, L_{f_1}, I) : (G, \cdot) \longrightarrow (G, \circ)$ is a Smarandache f, g -principal isotopism, so $x \cdot y = xR_g \circ yL_f, \forall x, y \in G$ and this implies

$$R_x = R_g \mathcal{R}_{xL_f} \text{ and } L_x = L_f \mathcal{L}_{xR_g}, \forall x \in G \text{ which also implies that}$$

$$\mathcal{R}_{xL_f} = R_g^{-1} R_x \text{ and } \mathcal{L}_{xR_g} = L_f^{-1} L_x, \forall x \in G \text{ which finally gives}$$

$$\mathcal{R}_x = R_g^{-1} R_{xL_f^{-1}} \text{ and } \mathcal{L}_x = L_f^{-1} L_{xR_g^{-1}}, \forall x \in G.$$

Set $f_2 = f\alpha R_{g_1}^{-1} R_g$ and $g_2 = g\alpha L_{f_1}^{-1} L_f$. Then

$$\mathcal{R}_{g_2} = R_g^{-1} R_{g\alpha L_{f_1}^{-1} L_f L_f^{-1}} = R_g^{-1} R_{g\alpha L_{f_1}^{-1}}, \quad (1)$$

$$\mathcal{L}_{f_2} = L_f^{-1} L_{f\alpha R_{g_1}^{-1} R_g R_g^{-1}} = L_f^{-1} L_{f\alpha R_{g_1}^{-1}}, \forall x \in G. \quad (2)$$

Since, $(\alpha R_{g_1}^{-1}, \alpha L_{f_1}^{-1}, \alpha) \in AUT(G, \cdot)$, then

$$(x\alpha R_{g_1}^{-1}) \cdot (y\alpha L_{f_1}^{-1}) = (x \cdot y)\alpha, \forall x, y \in G. \quad (3)$$

Putting $y = g$ and $x = f$ separately in the last equation,

$$x\alpha R_{g_1}^{-1}R_{(g\alpha L_{f_1}^{-1})} = xR_g\alpha \text{ and } y\alpha L_{f_1}^{-1}L_{(f\alpha R_{g_1}^{-1})} = yL_f\alpha, \forall x, y \in G.$$

Thus by applying (1) and (2), we now have

$$\alpha R_{g_1}^{-1} = R_g\alpha R_{(g\alpha L_{f_1}^{-1})}^{-1} = R_g\alpha \mathcal{R}_{g_2}^{-1}R_g^{-1} \text{ and } \alpha L_{f_1}^{-1} = L_f\alpha L_{(f\alpha R_{g_1}^{-1})}^{-1} = L_f\alpha \mathcal{L}_{f_2}^{-1}L_f^{-1}. \quad (4)$$

We shall now compute $(x \circ y)\alpha$ by (2) and (3) and then see the outcome.

$$(x \circ y)\alpha = (xR_g^{-1} \cdot yL_f^{-1})\alpha = xR_g^{-1}\alpha R_{g_1}^{-1} \cdot yL_f^{-1}\alpha L_{f_1}^{-1} = xR_g^{-1}R_g\alpha \mathcal{R}_{g_2}^{-1}R_g^{-1} \cdot yL_f^{-1}L_f\alpha \mathcal{L}_{f_2}^{-1}L_f^{-1} = x\alpha \mathcal{R}_{g_2}^{-1}R_g^{-1} \cdot y\alpha \mathcal{L}_{f_2}^{-1}L_f^{-1} = x\alpha \mathcal{R}_{g_2}^{-1} \circ y\alpha \mathcal{L}_{f_2}^{-1}, \forall x, y \in G.$$

Thus,

$$(x \circ y)\alpha = x\alpha \mathcal{R}_{g_2}^{-1} \circ y\alpha \mathcal{L}_{f_2}^{-1}, \forall x, y \in G \Leftrightarrow (\alpha \mathcal{R}_{g_2}^{-1}, \alpha \mathcal{L}_{f_2}^{-1}, \alpha) \in AUT(G, \circ) \Leftrightarrow \alpha \in SBS(G, \circ).$$

Whence, $SBS(G, \cdot) \subseteq SBS(G, \circ)$.

Since (G, \circ) is the Smarandache f, g -principal isotope of the S-loop (G, \cdot) , then by Theorem 3.4, (G, \cdot) is the Smarandache g, f -principal isotope of (G, \circ) . So following the steps above, it can similarly be shown that $SBS(G, \circ) \subseteq SBS(G, \cdot)$. Therefore, the conclusion that $SBS(G, \cdot) = SBS(G, \circ)$ follows. \square

3.3 Cardinality Formulas

Theorem 3.6 *Let (G, \cdot) be a finite Smarandache loop with n distinct S-subgroups. If the SBS group of (G, \cdot) relative to an S-subgroup (H_i, \cdot) is denoted by $SBS_i(G, \cdot)$, then*

$$|BS(G, \cdot)| = \frac{1}{n} \sum_{i=1}^n |SBS_i(G, \cdot)| [BS(G, \cdot) : SBS_i(G, \cdot)].$$

Proof Let the n distinct S-subgroups of G be denoted by H_i , $i = 1, 2, \dots, n$. Note here that $H_i \neq H_j$, $i, j = 1, 2, \dots, n$. By Theorem 3.1, $SBS_i(G, \cdot) \leq BS(G, \cdot)$, $i = 1, 2, \dots, n$. Hence, by the Lagrange's theorem of classical group theory,

$$|BS(G, \cdot)| = |SBS_i(G, \cdot)| [BS(G, \cdot) : SBS_i(G, \cdot)], i = 1, 2, \dots, n.$$

Thus, adding the equation above for all $i = 1, 2, \dots, n$, we get

$$n|BS(G, \cdot)| = \sum_{i=1}^n |SBS_i(G, \cdot)| [BS(G, \cdot) : SBS_i(G, \cdot)], i = 1, 2, \dots, n, \text{ thence,}$$

$$|BS(G, \cdot)| = \frac{1}{n} \sum_{i=1}^n |SBS_i(G, \cdot)| [BS(G, \cdot) : SBS_i(G, \cdot)].$$

\square

Theorem 3.7 *Let (G, \cdot) be a Smarandache loop. Then, $\Omega(G, \cdot) \leq AUT(G, \cdot)$.*

Proof Let (G, \cdot) be an S-loop with S-subgroup H . By Definition 2.7, it can easily be observed that $\Omega(G, \cdot) \subseteq AUT(G, \cdot)$.

Identity. If I is the identity mapping on G , then $hI = h \in H, \forall h \in H$ and there exists $e \in H$ where e is the identity element in G such that $(IR_e^{-1}, IL_e^{-1}, I) = (I, I, I) \in AUT(G, \cdot)$. So, $(I, I, I) \in \Omega(G, \cdot)$. Thus $\Omega(G, \cdot)$ is non-empty.

Closure and Inverse. Let $A, B \in \Omega(G, \cdot)$. Then there exist $\alpha, \beta \in SSYM(G, \cdot)$ and some $f_1, g_1, f_2, g_2 \in H$ such that

$$A = (\alpha R_{g_1}^{-1}, \alpha L_{f_1}^{-1}, \alpha), B = (\beta R_{g_2}^{-1}, \beta L_{f_2}^{-1}, \beta) \in AUT(G, \cdot).$$

$$AB^{-1} = (\alpha R_{g_1}^{-1}, \alpha L_{f_1}^{-1}, \alpha)(R_{g_2} \beta^{-1}, L_{f_2} \beta^{-1}, \beta^{-1})$$

$$= (\alpha R_{g_1}^{-1} R_{g_2} \beta^{-1}, \alpha L_{f_1}^{-1} L_{f_2} \beta^{-1}, \alpha \beta^{-1}) \in AUT(G, \cdot).$$

Using the same techniques for the proof of closure and inverse in Theorem 3.1 here and by letting $\delta = \beta R_{g_1}^{-1} R_{g_2} \beta^{-1}$ and $\gamma = \beta L_{f_1}^{-1} L_{f_2} \beta^{-1}$, it can be shown that,

$$AB^{-1} = (\alpha \beta^{-1} R_g^{-1}, \alpha \beta^{-1} L_f^{-1}, \alpha \beta^{-1}) \in AUT(G, \cdot) \text{ where } g = e \alpha \beta^{-1} \gamma, f = e \alpha \beta^{-1} \delta \in H$$

$$\text{such that } \alpha \beta^{-1} \in SSYM(G, \cdot) \Leftrightarrow AB^{-1} \in \Omega(G, \cdot).$$

Therefore, $\Omega(G, \cdot) \leq AUT(G, \cdot)$. □

Theorem 3.8 Let (G, \cdot) be a Smarandache loop with an S -subgroup H such that $f, g \in H$ and $\alpha \in SBS(G, \cdot)$. If the mapping

$$\Phi : \Omega(G, \cdot) \longrightarrow SBS(G, \cdot) \text{ is defined as } \Phi : (\alpha R_g^{-1}, \alpha L_f^{-1}, \alpha) \mapsto \alpha,$$

then Φ is an homomorphism.

Proof Let $A, B \in \Omega(G, \cdot)$. Then there exist $\alpha, \beta \in SSYM(G, \cdot)$ and some $f_1, g_1, f_2, g_2 \in H$ such that

$$A = (\alpha R_{g_1}^{-1}, \alpha L_{f_1}^{-1}, \alpha), B = (\beta R_{g_2}^{-1}, \beta L_{f_2}^{-1}, \beta) \in AUT(G, \cdot).$$

$\Phi(AB) = \Phi[(\alpha R_{g_1}^{-1}, \alpha L_{f_1}^{-1}, \alpha)(\beta R_{g_2}^{-1}, \beta L_{f_2}^{-1}, \beta)] = \Phi(\alpha R_{g_1}^{-1} \beta R_{g_2}^{-1}, \alpha L_{f_1}^{-1} \beta L_{f_2}^{-1}, \alpha \beta)$. It will be good if this can be written as; $\Phi(AB) = \Phi(\alpha \beta \delta, \alpha \beta \gamma, \alpha \beta)$ such that $h \alpha \beta \in H \forall h \in H$ and $\delta = R_g^{-1}, \gamma = L_f^{-1}$ for some $g, f \in H$.

This is done as follows. If

$$(\alpha R_{g_1}^{-1} \beta R_{g_2}^{-1}, \alpha L_{f_1}^{-1} \beta L_{f_2}^{-1}, \alpha \beta) = (\alpha \beta \delta, \alpha \beta \gamma, \alpha \beta) \in AUT(G, \cdot), \text{ then,}$$

$$x \alpha \beta \delta \cdot y \alpha \beta \gamma = (x \cdot y) \alpha \beta, \forall x, y \in G.$$

Put $y = e$ and replace x by $x \beta^{-1} \alpha^{-1}$ then $x \delta \cdot e \alpha \beta \gamma = x \Leftrightarrow \delta = R_{e \alpha \beta \gamma}^{-1}$.

Similarly, put $x = e$ and replace y by $y \beta^{-1} \alpha^{-1}$. Then, $e \alpha \beta \delta \cdot y \gamma = y \Leftrightarrow \gamma = L_{e \alpha \beta \delta}^{-1}$. So,

$$\Phi(AB) = (\alpha \beta R_{e \alpha \beta \gamma}^{-1}, \alpha \beta L_{e \alpha \beta \delta}^{-1}, \alpha \beta) = \alpha \beta = \Phi(\alpha R_{g_1}^{-1}, \alpha L_{f_1}^{-1}, \alpha) \Phi(\beta R_{g_2}^{-1}, \beta L_{f_2}^{-1}, \beta) = \Phi(A) \Phi(B).$$

Therefore, Φ is an homomorphism. \square

Theorem 3.9 Let (G, \cdot) be a Smarandache loop with an S -subgroup H such that $f, g \in H$ and $\alpha \in SSYM(G, \cdot)$. If the mapping

$$\Phi : \Omega(G, \cdot) \longrightarrow SBS(G, \cdot) \text{ is defined as } \Phi : (\alpha R_g^{-1}, \alpha L_f^{-1}, \alpha) \mapsto \alpha$$

then,

$$A = (\alpha R_g^{-1}, \alpha L_f^{-1}, \alpha) \in \ker \Phi \text{ if and only if } \alpha$$

is the identity map on G , $g \cdot f$ is the identity element of (G, \cdot) and $g \in N_\mu(G, \cdot)$ the middle nucleus of (G, \cdot) .

Proof For the necessity, $\ker \Phi = \{A \in \Omega(G, \cdot) : \Phi(A) = I\}$. So, if $A = (\alpha R_{g_1}^{-1}, \alpha L_{f_1}^{-1}, \alpha) \in \ker \Phi$, then $\Phi(A) = \alpha = I$. Thus, $A = (R_{g_1}^{-1}, L_{f_1}^{-1}, I) \in AUT(G, \cdot) \Leftrightarrow$

$$x \cdot y = xR_g^{-1} \cdot yL_f^{-1}, \forall x, y \in G. \quad (5)$$

Replace x by xR_g and y by yL_f in (5) to get

$$x \cdot y = xg \cdot fy, \forall x, y \in G. \quad (6)$$

Putting $x = y = e$ in (6), we get $g \cdot f = e$. Replace y by yL_f^{-1} in (6) to get

$$x \cdot yL_f^{-1} = xg \cdot y, \forall x, y \in G. \quad (7)$$

Put $x = e$ in (7), then we have $yL_f^{-1} = g \cdot y, \forall y \in G$ and so (7) now becomes

$$x \cdot (gy) = xg \cdot y, \forall x, y \in G \Leftrightarrow g \in N_\mu(G, \cdot).$$

For the sufficiency, let α be the identity map on G , $g \cdot f$ the identity element of (G, \cdot) and $g \in N_\mu(G, \cdot)$. Thus, $fg \cdot f = f \cdot gf = fe = f$. Thus, $f \cdot g = e$. Then also, $y = fg \cdot y = f \cdot gy \forall y \in G$ which results into $yL_f^{-1} = gy \forall y \in G$. Thus, it can be seen that $x\alpha R_g^{-1} \cdot y\alpha L_f^{-1} = xR_g^{-1} \cdot yL_f^{-1} = xR_g^{-1} \alpha \cdot yL_f^{-1} \alpha = xR_g^{-1} \cdot yL_f^{-1} = xR_g^{-1} \cdot gy = (xR_g^{-1} \cdot g)y = xR_g^{-1} R_g \cdot y = x \cdot y = (x \cdot y)\alpha, \forall x, y \in G$. Thus, $\Phi(A) = \Phi(\alpha R_g^{-1}, \alpha L_f^{-1}, \alpha) = \Phi(R_g^{-1}, L_f^{-1}, I) = I \Rightarrow A \in \ker \Phi$. \square

Theorem 3.10 Let (G, \cdot) be a Smarandache loop with an S -subgroup H such that $f, g \in H$ and $\alpha \in SSYM(G, \cdot)$. If the mapping

$$\Phi : \Omega(G, \cdot) \longrightarrow SBS(G, \cdot) \text{ is defined as } \Phi : (\alpha R_g^{-1}, \alpha L_f^{-1}, \alpha) \mapsto \alpha$$

then,

$$|N_\mu(G, \cdot)| = |\ker \Phi| \text{ and } |\Omega(G, \cdot)| = |SBS(G, \cdot)| |N_\mu(G, \cdot)|.$$

Proof Let the identity map on G be I . Using Theorem 3.9, if

$$g\theta = (R_g^{-1}, L_g^{-1}, I), \forall g \in N_\mu(G, \cdot) \text{ then, } \theta : N_\mu(G, \cdot) \longrightarrow \ker \Phi.$$

θ is easily seen to be a bijection, hence $|N_\mu(G, \cdot)| = |\ker \Phi|$.

Since Φ is an homomorphism by Theorem 3.8, then by the first isomorphism theorem in classical group theory, $\Omega(G, \cdot)/\ker \Phi \cong \text{Im}\Phi$. Φ is clearly onto, so $\text{Im}\Phi = SBS(G, \cdot)$, so that $\Omega(G, \cdot)/\ker \Phi \cong SBS(G, \cdot)$. Thus, $|\Omega(G, \cdot)/\ker \Phi| = |SBS(G, \cdot)|$. By Lagrange's theorem, $|\Omega(G, \cdot)| = |\ker \Phi||\Omega(G, \cdot)/\ker \Phi|$, so, $|\Omega(G, \cdot)| = |\ker \Phi||SBS(G, \cdot)|$, $\therefore |\Omega(G, \cdot)| = |N_\mu(G, \cdot)||SBS(G, \cdot)|$. \square

Theorem 3.11 *Let (G, \cdot) be a Smarandache loop with an S -subgroup H . If*

$$\Theta(G, \cdot) = \{(f, g) \in H \times H : (G, \circ) \succsim (G, \cdot) \\ \text{for } (G, \circ) \text{ the Smarandache principal } f, g - \text{isotope of } (G, \cdot)\},$$

then

$$|\Omega(G, \cdot)| = |\Theta(G, \cdot)||SA(G, \cdot)|.$$

Proof Let $A, B \in \Omega(G, \cdot)$. Then there exist $\alpha, \beta \in SSYM(G, \cdot)$ and some $f_1, g_1, f_2, g_2 \in H$ such that

$$A = (\alpha R_{g_1}^{-1}, \alpha L_{f_1}^{-1}, \alpha), B = (\beta R_{g_2}^{-1}, \beta L_{f_2}^{-1}, \beta) \in AUT(G, \cdot).$$

Define a relation \sim on $\Omega(G, \cdot)$ such that

$$A \sim B \iff f_1 = f_2 \text{ and } g_1 = g_2.$$

It is very easy to show that \sim is an equivalence relation on $\Omega(G, \cdot)$. It can easily be seen that the equivalence class $[A]$ of $A \in \Omega(G, \cdot)$ is the inverse image of the mapping

$$\Psi : \Omega(G, \cdot) \longrightarrow \Theta(G, \cdot) \text{ defined as } \Psi : (\alpha R_{g_1}^{-1}, \alpha L_{f_1}^{-1}, \alpha) \mapsto (f, g).$$

If $A, B \in \Omega(G, \cdot)$ then $\Psi(A) = \Psi(B)$ if and only if $(f_1, g_1) = (f_2, g_2)$ so, $f_1 = f_2$ and $g_1 = g_2$. Since $\Omega(G, \cdot) \leq AUT(G, \cdot)$ by Theorem 3.7, then $AB^{-1} = (\alpha R_{g_1}^{-1}, \alpha L_{f_1}^{-1}, \alpha)(\beta R_{g_2}^{-1}, \beta L_{f_2}^{-1}, \beta)^{-1} = (\alpha R_{g_1}^{-1} R_{g_2} \beta^{-1}, \alpha L_{f_1}^{-1} L_{f_2} \beta^{-1}, \alpha \beta^{-1}) = (\alpha \beta^{-1}, \alpha \beta^{-1}, \alpha \beta^{-1}) \in AUT(G, \cdot) \iff \alpha \beta^{-1} \in SA(G, \cdot)$. So,

$$A \sim B \iff \alpha \beta^{-1} \in SA(G, \cdot) \text{ and } (f_1, g_1) = (f_2, g_2).$$

Whence, $|[A]| = |SA(G, \cdot)|$. But each $A = (\alpha R_g^{-1}, \alpha L_f^{-1}, \alpha) \in \Omega(G, \cdot)$ is determined by some $f, g \in H$. So since the set $\{[A] : A \in \Omega(G, \cdot)\}$ of all equivalence classes partitions $\Omega(G, \cdot)$ by the fundamental theorem of equivalence relation,

$$|\Omega(G, \cdot)| = \sum_{f, g \in H} |[A]| = \sum_{f, g \in H} |SA(G, \cdot)| = |\Theta(G, \cdot)||SA(G, \cdot)|.$$

Therefore, $|\Omega(G, \cdot)| = |\Theta(G, \cdot)||SA(G, \cdot)|$. \square

Theorem 3.12 *Let (G, \cdot) be a finite Smarandache loop with a finite S -subgroup H . (G, \cdot) is S -isomorphic to all its S -loop S -isotopes if and only if*

$$|(H, \cdot)|^2 |SA(G, \cdot)| = |SBS(G, \cdot)||N_\mu(G, \cdot)|.$$

Proof As shown in [Corollary 5.2, [12]], an S-loop is S-isomorphic to all its S-loop S-isotopes if and only if it is S-isomorphic to all its Smarandache f, g principal isotopes. This will happen if and only if $H \times H = \Theta(G, \cdot)$ where $\Theta(G, \cdot)$ is as defined in Theorem 3.11.

Since $\Theta(G, \cdot) \subseteq H \times H$ then it is easy to see that for a finite Smarandache loop with a finite S-subgroup H , $H \times H = \Theta(G, \cdot)$ if and only if $|H|^2 = |\Theta(G, \cdot)|$. So the proof is complete by Theorems 3.10 – 3.11. \square

Corollary 3.3 *Let (G, \cdot) be a finite Smarandache loop with a finite S-subgroup H . (G, \cdot) is a GS-loop if and only if*

$$|(H, \cdot)|^2 |SA(G, \cdot)| = |SBS(G, \cdot)| |N_\mu(G, \cdot)|.$$

Proof This follows by the definition of a GS-loop and Theorem 3.12. \square

Lemma 3.1 *Let (G, \cdot) be a finite GS-loop with a finite S-subgroup H and a middle nucleus $N_\mu(G, \cdot)$.*

$$|(H, \cdot)| = |N_\mu(G, \cdot)| \iff |(H, \cdot)| = \frac{|SBS(G, \cdot)|}{|SA(G, \cdot)|}.$$

Proof From Corollary 3.3,

$$|(H, \cdot)|^2 |SA(G, \cdot)| = |SBS(G, \cdot)| |N_\mu(G, \cdot)|.$$

(1) If $|(H, \cdot)| = |N_\mu(G, \cdot)|$, then

$$|(H, \cdot)| |SA(G, \cdot)| = |SBS(G, \cdot)| \implies |(H, \cdot)| = \frac{|SBS(G, \cdot)|}{|SA(G, \cdot)|}.$$

(2) If $|(H, \cdot)| = \frac{|SBS(G, \cdot)|}{|SA(G, \cdot)|}$, then $|(H, \cdot)| |SA(G, \cdot)| = |SBS(G, \cdot)|$. Hence, multiplying both sides by $|(H, \cdot)|$,

$$|(H, \cdot)|^2 |SA(G, \cdot)| = |SBS(G, \cdot)| |(H, \cdot)|.$$

So that

$$|SBS(G, \cdot)| |N_\mu(G, \cdot)| = |SBS(G, \cdot)| |(H, \cdot)| \implies |(H, \cdot)| = |N_\mu(G, \cdot)|.$$

\square

Corollary 3.4 *Let (G, \cdot) be a finite GS-loop with a finite S-subgroup H . If $|N_\mu(G, \cdot)| \geq 1$, then,*

$$|(H, \cdot)| = \frac{|SBS(G, \cdot)|}{|SA(G, \cdot)|}. \text{ Hence, } |(G, \cdot)| = \frac{n|SBS(G, \cdot)|}{|SA(G, \cdot)|} \text{ for some } n \geq 1.$$

Proof By hypothesis, $\{e\} \neq H \neq G$. In a loop, $N_\mu(G, \cdot)$ is a subgroup, hence if $|N_\mu(G, \cdot)| \geq 1$, then, we can take $(H, \cdot) = N_\mu(G, \cdot)$. So that $|(H, \cdot)| = |N_\mu(G, \cdot)|$. Thus by Lemma 3.1, $|(H, \cdot)| = \frac{|SBS(G, \cdot)|}{|SA(G, \cdot)|}$.

As shown in [Section 1.3, [8]], a loop L obeys the Lagrange's theorem relative to a subloop H if and only if $H(hx) = Hx$ for all $x \in L$ and for all $h \in H$. This condition is obeyed by $N_\mu(G, \cdot)$, hence

$$|(H, \cdot)| \mid |(G, \cdot)| \implies \frac{|SBS(G, \cdot)|}{|SA(G, \cdot)|} \mid |(G, \cdot)| \implies$$

there exists $n \in \mathbb{N}$ such that

$$|(G, \cdot)| = \frac{n|SBS(G, \cdot)|}{|SA(G, \cdot)|}.$$

But if $n = 1$, then $|(G, \cdot)| = |(H, \cdot)| \implies (G, \cdot) = (H, \cdot)$ hence (G, \cdot) is a group which is a contradiction to the fact that (G, \cdot) is an S-loop. Therefore,

$$|(G, \cdot)| = \frac{n|SBS(G, \cdot)|}{|SA(G, \cdot)|}$$

for some natural numbers $n \geq 1$. □

References

- [1] J. O. Adeniran (2002), *The study of properties of certain class of loops via their Bryant-Schneider group*, Ph.D thesis, University of Agriculture, Abeokuta.
- [2] J. O. Adeniran (2002), More on the Bryant-Schneider group of a conjugacy closed loop. Proc. Jangjeon Math. Soc. 5, no. 1, 35–46.
- [3] R. H. Bruck (1966), *A survey of binary systems*, Springer-Verlag, Berlin-Göttingen-Heidelberg, 185pp.
- [4] B. F. Bryant and H. Schneider (1966), Principal loop-isotopes of quasigroups, *Canad. J. Math.* 18, 120-125.
- [5] O. Chein, H. O. Pflugfelder and J. D. H. Smith (1990), *Quasigroups and loops : Theory and applications*, Heldermann Verlag, 568pp.
- [6] V. O. Chiboka (1996), The Bryant-Schneider group of an extra loop, *Collection of Scientific papers of the Faculty of Science*, Kragujevac, 18, 9-20.
- [7] J. Déne and A. D. Keedwell (1974), *Latin squares and their applications*, the English University press Lts, 549pp.
- [8] E. G. Goodaire, E. Jaspers and C. P. Milies (1996), *Alternative loop rings*, NHMS(184), Elsevier, 387pp.
- [9] T. G. Jáíyéplá (2006), An holomorphic study of the Smarandache concept in loops, *Scientia Magna Journal*, Vol.2, No.1, 1-8.
- [10] T. G. Jáíyéplá (2006), Parastrophic invariance of Smarandache quasigroups, *Scientia Magna Journal*, Vol.2, No.3, 48-53.
- [11] T. G. Jáíyéplá (2006), On the universality of some Smarandache loops of Bol-Moufang type, *Scientia Magna Journal*, Vol.2, No.4, 45-48.
- [12] T. G. Jáíyéplá (2008), Smarandache isotopy theory of Smarandache: quasigroups and loops, Proceedings of the 4th International Conference on Number Theory and Smarandache Problems, *Scientia Magna Journal*. Vol.4, No.1, 168-177.

- [13] A. S. Muktibodh (2006), Smarandache quasigroups, *Scientia Magna Journal*, Vol.2, No.1, 13-19.
- [14] H. O. Pflugfelder (1990), Quasigroups and loops : Introduction, *Sigma series in Pure Math.* 7, Heldermann Verlag, Berlin, 147pp.
- [15] D. A. Robinson (1980), The Bryant-Schneider group of a loop, *Extract Des Ann. De la Sociét é Sci.* De Brucellaes, Tome 94, II-II, 69–81.
- [16] W. B. Vasantha Kandasamy (2002), *Smarandache loops*, Department of Mathematics, Indian Institute of Technology, Madras, India, 128pp.
- [17] W. B. Vasantha Kandasamy (2002), Smarandache Loops, *Smarandache notions journal*, 13, 252-258.

Some Properties of Nilpotent Lattice Matrices

Qiyi Fan

(Department of Mathematics of Hunan University of Arts and Science, Changde 415000, P.R.China.)

E-mail: zjl.man06@yahoo.com.cn

Abstract: In this paper, the nilpotent matrices over distributive lattices are discussed by applying the combinatorial speculation ([9]). Some necessary and sufficient conditions for a lattice matrix A to be a nilpotent matrix are given. Also, a necessary and sufficient condition for an $n \times n$ nilpotent matrix with an arbitrary nilpotent index is obtained.

Key Words: distributive lattice, nilpotent matrix; nilpotent index; direct path.

AMS(2000):

§1. Introduction

Since the concept of nilpotent lattice matrix was introduced by Give'on in [2], a number of researchers have studied the topic of nilpotent lattice matrices(see e.g. [2-8]). In [7], Li gave some sufficient and necessary conditions for a fuzzy matrix to be nilpotent and proved that an $n \times n$ fuzzy matrix A is nilpotent if and only if the elements on the main diagonal of the k th power A^k of A are 0 for each k in $\{1, 2, \dots, n\}$. Ren et al.(see [8]) obtained some characterizations of nilpotent fuzzy matrices, and revealed that a fuzzy matrix A is nilpotent if and only if every principal minor of A is 0. This result was generalized to the class of distributive lattices by Tan(see [3,5]) and Zhang(see [4]). In particular, Tan gave a necessary and sufficient condition for an $n \times n$ nilpotent matrix to have the nilpotent index n in [3].

In this paper, we discuss the topic of nilpotent lattices matrices. In Section 3, we will give some characterizations of the nilpotent lattice matrices by applying the combinatorial speculation ([9]). In Section 4, a necessary and sufficient condition for an $n \times n$ nilpotent matrix with an arbitrary nilpotent index will be obtained, this result provide an answer to the open problem posed by Tan in [3].

§2. Definitions and Lemmas

For convenience, we shall use N to denote the set $\{1, 2, \dots, n\}$ and use $|S|$ to denote the cardinality of a set S .

Let (L, \leq, \vee, \wedge) be a distributive lattice with a bottom element 0 and a top element 1 and $M_n(L)$ be the set of all $n \times n$ matrices over L .

For $A \in M_n(L)$, the powers of A are defined as follows: $A^0 = I_n, A^r = A^{r-1}A, r = 1, 2, \dots$. The (i, j) -entry of A^r is denoted by a_{ij}^r .

¹Received February 26, 2008. Accepted April 2, 2008.

A is called the zero matrix if for all $i, j \in N$, $a_{ij} = 0$ and denoted by 0 . Let $A \in M_n(L)$. If there exists $k \geq 1$, $A^k = 0$, then A is called a nilpotent matrix. The least integer k satisfying $A^k = 0$ is called the nilpotent index of A and denoted by $h(A)$.

For $A \in M_n(L)$, the permanent $\text{per}A$ of A is defined as follows:

$$\text{per}A = \bigvee_{\sigma \in P_n} a_{1\sigma(1)} a_{2\sigma(2)} \cdots a_{n\sigma(n)},$$

where P_n denotes the symmetric group of the set N .

For a matrix $A \in M_n(L)$, we denote by $A[i_1, i_2, \dots, i_r | j_1, j_2, \dots, j_r]$ the $r \times r$ submatrix of A whose (u, v) -entry is equal to $a_{i_u j_v}$ ($u, v \in R$). The matrix $A[i_1, i_2, \dots, i_r | i_1, i_2, \dots, i_r]$ is called a principal submatrix of order r of A , and $\text{per}A[i_1, i_2, \dots, i_r | i_1, i_2, \dots, i_r]$ is called a principal minor of order r of A .

For a given matrix $A \in M_n(L)$, the associated graph $G(A) : G(A) = (V, H)$ of A is the strongly complete directed weighted graph with the node set $V = N$, the arc set $H = \{(i, j) \in N \times N | a_{ij} \neq 0\}$.

For a given matrix $A \in M_n(L)$, a sequence of nodes $p = (i_0, i_1, \dots, i_r)$ of the graph $G(A) = (V, H)$ is called a path if $(i_{k-1}, i_k) \in H$ for all $k = 1, 2, \dots, r-1$. These arcs, together with the nodes i_k for $k = 0, 1, \dots, r$, are said to be on the path p . The length of a path, denoted by $l(p)$, is the number of arcs on it, in the former case, $l(p) = r$. If all nodes on a path p are pairwise distinct, then p is called a chain. A path $p = (i_0, i_1, \dots, i_{r-1}, i_0)$ with i_0, i_1, \dots, i_{r-1} are pairwise distinct is called a cycle. For a given matrix $A \in M_n(L)$, we define:

$$C(A) = \{p | p \text{ is a cycle of } G(A)\}.$$

And for any $r \leq n$, we define:

$$S_r(A) = \{p | p \text{ is a chain of } G(A) \text{ and } l(p) = r\}.$$

For any path $p = (i_0, i_1, \dots, i_r)$ of $G(A)$, the weight of p with respect to A , will be denoted by $W_A(p)$, is defined as

$$W_A(p) = a_{i_0 i_1} \wedge a_{i_1 i_2} \wedge \cdots \wedge a_{i_{r-1} i_r} = a_{i_0 i_1} a_{i_1 i_2} \cdots a_{i_{r-1} i_r}.$$

The following lemmas are used.

Lemma 2.1([2]) *Let $A \in M_n(L)$. Then A is nilpotent if and only if $A^n = 0$.*

Lemma 2.2([4]) *Let $A = (a_{ij}) \in M_n(L)$, $A^m = (a_{ij}^m)$. Then*

$$a_{ij}^m = \bigvee_{1 \leq i_1, i_2, \dots, i_{m-1} \leq n} a_{i i_1} a_{i_1 i_2} \cdots a_{i_{m-1} j}.$$

Lemma 2.3([4],[5]) *Let $A \in M_n(L)$. Then A is a nilpotent matrix if and only if*

$$\text{per}A[i_1, i_2, \dots, i_k | i_1, i_2, \dots, i_k] = 0,$$

for all $\{i_1, i_2, \dots, i_k\} \subset N$, $k \in N$.

Lemma 2.4([4]) *Let A be a nilpotent matrix over L . Then*

$$a_{r_1 r_2} a_{r_2 r_3} \cdots a_{r_{m-1} r_m} a_{r_m r_1} = 0,$$

for all $\{r_1, r_2, \dots, r_m\} \subseteq N$.

§3. Characterizations of the Nilpotent Lattice Matrices

In this section, we will give some new necessary and sufficient conditions for a lattice matrix to be a nilpotent matrix.

Theorem 3.1 *Let $A \in M_n(L)$. Then A is a nilpotent matrix if and only if for all $p \in C(A)$, $W_A(p) = 0$.*

Proof (\implies) By Lemma 2.4, if A is a nilpotent matrix, then for all $p = (i_0, i_1, \dots, i_{r-1}, i_0) \in C(A)$, $W_A(p) = a_{i_0 i_1} a_{i_1 i_2} \cdots a_{i_{r-1} i_0} = 0$.

(\impliedby) If for all $p \in C(A)$, $W_A(p) = 0$, we prove $A^n = 0$. By Lemma 2.2, for any typical term $a_{i i_1} a_{i_1 i_2} \cdots a_{i_{n-1} j}$ of a_{ij}^n , there must be repetitions amongst the $n+1$ suffixes $i = i_0, i_1, \dots, i_{n-1}, j = i_n$. Suppose that i_s ($1 \leq s \leq n$) is the first one which $i_s \in \{i_0, i_1, \dots, i_{s-1}\}$, then there exists i_t ($0 \leq t \leq s-1$), such that $i_t = i_s$, so, $(i_t, i_{t+1}, \dots, i_s) \in C(A)$. Hence

$$a_{i i_1} a_{i_1 i_2} \cdots a_{i_{n-1} j} \leq a_{i_t i_{t+1}} \cdots a_{i_{s-1} i_s} = 0,$$

and

$$a_{ij}^n = \bigvee_{1 \leq i_1, i_2, \dots, i_{n-1} \leq n} a_{i i_1} a_{i_1 i_2} \cdots a_{i_{n-1} j} = 0, \quad \forall i, j \in N.$$

That is to say, $A^n = 0$. By Lemma 2.1, A is nilpotent. \square

Example 3.1 Consider the lattice L whose diagram is displayed in Fig.1.

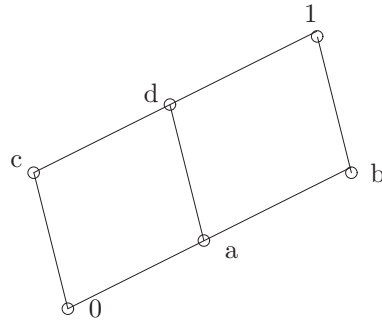

Fig.1

Obviously, L is a distributive lattice. Now let

$$A = \begin{pmatrix} 0 & a & 0 \\ c & 0 & 0 \\ 0 & 1 & 0 \end{pmatrix} \in M_3(L).$$

then $C(A) = \{(1, 2, 1), (2, 1, 2)\}$, and for any element p of $C(A)$, $W_A(p) = a \wedge c = 0$, hence A is a nilpotent matrix. In fact, $A^3 = 0$.

Theorem 3.2 *Let $A \in M_n(L)$. Then A is a nilpotent matrix if and only if all principal submatrices of A are nilpotent.*

Proof. (\Leftarrow) Since matrix A is a principal submatrix of matrix A , A is a nilpotent matrix.

(\Rightarrow) Let $B = (b_{ij}) = A[i_1, i_2, \dots, i_t | i_1, i_2, \dots, i_t]$ is an arbitrary principal submatrix of A and let $p_1 = (k_0, k_1, \dots, k_{r-1}, k_0) \in C(B)$. Then

$$W_B(p_1) = b_{k_0 k_1} b_{k_1 k_2} \cdots b_{k_{r-1} k_0} = a_{i_{k_0} i_{k_1}} a_{i_{k_1} i_{k_2}} \cdots a_{i_{k_{r-1}} i_{k_0}}.$$

Obviously, path $p = (i_{k_0}, i_{k_1}, \dots, i_{k_{r-1}}, i_{k_0})$ is a cycle of $G(A)$, so, by Theorem 3.1, we have

$$W_A(p) = a_{i_{k_0} i_{k_1}} a_{i_{k_1} i_{k_2}} \cdots a_{i_{k_{r-1}} i_{k_0}} = 0.$$

Hence

$$W_B(p_1) = W_A(p) = 0.$$

Applying Theorem 3.1, $A[i_1, i_2, \dots, i_t | i_1, i_2, \dots, i_t]$ is a nilpotent matrix. This completes the proof. \square

Let

$$A = \begin{pmatrix} A_1 & B \\ 0 & A_2 \end{pmatrix},$$

where A_1 be a $m \times m$ matrix and A_2 be a $n \times n$ matrix over distributive lattice L . Then for any $p \in C(A)$, $p \in C(A_1)$ or $p \in C(A_2)$. Hence we have the following corollary.

Corollary 3.1 *Let*

$$A = \begin{pmatrix} A_1 & B \\ 0 & A_2 \end{pmatrix},$$

where A_1 be a $m \times m$ matrix and A_2 be a $n \times n$ matrix over distributive lattice L . Then A is a nilpotent matrix if and only if A_1 and A_2 are nilpotent matrices.

Corollary 3.2 *Let L be a distributive lattice,*

$$A = \begin{pmatrix} A_1 & * & \cdots & * \\ 0 & A_2 & \cdots & * \\ \vdots & \vdots & \ddots & \vdots \\ 0 & 0 & \cdots & A_k \end{pmatrix} \in M_n(L),$$

where $A_i \in M_{n(i)}(L)$, $i = 1, 2, \dots, k$, and $n = n(1) + n(2) + \cdots + n(k)$. Then A is a nilpotent matrix if and only if A_1, A_2, \dots, A_k are all nilpotent matrices.

§4. A Characterization of Lattice Matrices with an Arbitrary Nilpotent Index

If A is a zero matrix, then $h(A) = 1$; if A is a nonzero nilpotent matrix, then $h(A) \geq 2$. In the following discussion, we always suppose that A is a nonzero matrix.

If $p = (i_0, i_1, \dots, i_{r-1}) \in S_{r-1}(A)$ and $W_A(p) \neq 0$, then $a_{i_0 i_1} a_{i_1 i_2} \cdots a_{i_{r-2} i_{r-1}} = W_A(p)$ is a term of $a_{i_0 i_{r-1}}^{r-1}$, so, $A^{r-1} \neq 0$. Hence, we have

Lemma 4.1 *Let $A \in M_n(L)$ be a nilpotent matrix. If there exists $p \in S_{r-1}(A)$, such that $W_A(p) \neq 0$, then $h(A) \geq r$.*

Example 3.1(continued). Since $p = (3, 2, 1) \in S_2(A)$ and $W_A(p) = 1 \wedge c = c \neq 0$, we have $h(A) \geq 3$, i.e., $h(A) = 3$.

Lemma 4.2 *Let $A \in M_n(L)$ be a nilpotent matrix. If $S_r(A) = \emptyset$ or for every $p \in S_r(A)$, $W_A(p) = 0$, then $h(A) \leq r$.*

Proof Suppose that $a_{i i_1} a_{i_1 i_2} \cdots a_{i_{r-1} j}$ is a typical term of a_{ij}^r . If $|\{i, i_1, \dots, i_{r-1}, j\}| < r+1$, let i_s ($1 \leq s \leq r, i = i_0, j = i_r$) be the first one which $i_s \in \{i, i_1, \dots, i_{s-1}\}$, then there exists i_t ($0 \leq t \leq s-1$), such that $i_s = i_t$, so, $(i_t, i_{t+1}, \dots, i_s) \in C(A)$, therefore, we have

$$a_{i i_1} a_{i_1 i_2} \cdots a_{i_{r-1} j} \leq a_{i i_{t+1}} \cdots a_{i_{s-1} i_s} = 0.$$

If $|\{i, i_1, \dots, i_{r-1}, j\}| = r+1$, then $(i, i_1, \dots, i_{r-1}, j) \in S_r(A)$, so

$$W_A(p) = a_{i i_1} a_{i_1 i_2} \cdots a_{i_{r-1} j} = 0.$$

Thus, for any $i, j \in N$ and in any cases, we can obtain:

$$a_{i i_1} a_{i_1 i_2} \cdots a_{i_{r-1} j} = 0.$$

Therefore

$$a_{ij}^r = \bigvee_{1 \leq i_1, i_2, \dots, i_{r-1} \leq n} a_{i i_1} a_{i_1 i_2} \cdots a_{i_{r-1} j} = 0, \quad \forall i, j \in N.$$

This means that $A^r = 0$, i.e., $h(A) \leq r$. \square

Now, a characterization on lattice matrices with an arbitrary nilpotent index can be given in the following.

Theorem 4.1 *Let $A \in M_n(L)$ be a nilpotent matrix. Then $h(A) = r$ ($r \in N$) if and only if there exists $p \in S_{r-1}(A)$, $W_A(p) \neq 0$ and for all $p \in S_r(A)$, $W_A(p) = 0$.*

Proof (\Leftarrow) If A is a nilpotent matrix, by Lemma 4.1, $h(A) \geq r$, and by Lemma 4.2, $h(A) \leq r$, thus $h(A) = r$.

(\Rightarrow) Since $h(A) = r$ implies $A^{r-1} \neq 0$, there exist $i_0, i_1, \dots, i_{r-2}, j_0 \in N$, such that $a_{i_0 i_1} a_{i_1 i_2} \cdots a_{i_{r-2} j_0} \neq 0$, by Lemma 2.4, this means that $i_0, i_1, \dots, i_{r-2}, j_0$ are pairwise distinct, i.e., there exists $p = (i_0, i_1, \dots, i_{r-2}, j_0) \in S_{r-1}(A)$, $W_A(p) = a_{i_0 i_1} a_{i_1 i_2} \cdots a_{i_{r-2} j_0} \neq 0$. On the other hand, if $h(A) = r$, then for all $p \in S_r(A)$, $W_A(p) = 0$ (otherwise, if there exist $p \in S_r(A)$, $W_A(p) \neq 0$, by lemma 4.1, $h(A) \geq r+1$, this is a contradiction). \square

References

- [1] B.A. Davey, H.A. Priestley, *Introduction to Lattice and Order*, London: Cambridge Univ. Press, 2002.
- [2] Y. Give'on, Lattice matrices, *Inform. Control* 7(1964)477-484.
- [3] Y.J. Tan, On nilpotent matrices over distributive lattices, *Fuzzy Sets and Systems* 151(2005)421-433.
- [4] K.L. Zhang, On the nilpotent matrices over D_{01} -lattice, *Fuzzy Sets and Systems* 117(2001)403-406.
- [5] Y.J. Tan, On the powers of matrices over a distributive lattice, *Linear Algebra Appl.* 336(2001)1-14.
- [6] S.Ch. Han, H.X. Li and J.Y. Wang, On nilpotent incline matrices, *Linear Algebra Appl.* 406(2005)201-217.
- [7] J.X. Li, Some results on the nilpotent fuzzy matrices (in Chinese), *Fuzzy Systems Math.* 3(1989)52-55.
- [8] H.T. Ren, Z. Zhang, Z.S. Liu, A necessary and sufficient condition for nilpotent fuzzy matrices (in Chinese), *Acta Sci. Natur. Univ. Nei Monggol* 27(1996)594-596.
- [9] L.F.Mao, Combinatorial speculation and the combinatorial conjecture for mathematics, *Selected Papers on Mathematical Combinatorics(I)*, 1-22, World Academic Union, 2006.

On the Crossing Number of the Join of Some 5-Vertex Graphs and P_n

Bo Li, Jing Wang and Yuanqiu Huang

(Department of Mathematics, Normal University of Hunan, Changsha 410081, P.R.China.)

E-mail: leebo@live.cn; wangjing1001@hotmail.com; hyqq@public.cs.hn.cn

Abstract: In this paper, we study the join of graphs, and give the values of crossing numbers for join products $G_i \vee P_n$ for some graphs $G_i (i = 2, 5, 6, 9)$ of order five, which is related with parallel bundles on planar map geometries ([10]), a kind of planar Smarandache geometries.

Key Words: graph, crossing number, join, drawing, path.

AMS(2000): 05C10, 05C62

§1. Introduction

A *drawing* D of a graph G on a surface S consists of an immersion of G in S such that no edge has a vertex as an interior point and no point is an interior point of three edges. We say a drawing of G is a good drawing if the following conditions holds.

- (i) no edge has a self-intersection;
- (ii) no two adjacent edges intersect;
- (iii) no two edges intersect each other more than once;
- (iv) each intersection of edges is a crossing rather than tangential.

Let G be a simple graph with vertex set V and edge set E . The *crossing number* $cr(G)$ of a graph G is the smallest number of pairs of nonadjacent edges that intersect in a drawing of G in the plane. An *optimal drawing* of a graph G is a drawing whose number of crossings equals $cr(G)$. Let A and B be disjoint edge subsets of G . We denote by $cr_D(A, B)$ the number of crossings between edges of A and B , and by $cr_D(A)$ the number of crossings whose two crossed edges are both in A . Let H be a subgraph of G , the restricted drawing $D|_H$ is said to be a *subdrawing* of H . As for more on the theory of crossing numbers, we refer readers to [1] and [2]. In this paper, we shall often use the term *region* also in non-planar drawings. In this case, crossing are considered to be vertices of the map.

Let G and H be two disjoint graphs. The *union* of G and H , denoted by $G + H$, has vertex set $V(G) \cup V(H)$ and edge set $E(G) \cup E(H)$. And the *join* of G and H is obtained by adjoining every vertex of G to every vertex of H in $G + H$ which is denoted by $G \vee H$ (see [3]).

¹Received March 6, 2008. Accepted April 6, 2008.

²This project is supported by National Natural Science Foundation of China (10771062) and New Century Excellent Talents in University (NCET-07-0276).

Let $K_{m,n}$ denote the complete bipartite graph on sets of m and n vertices, that is, the graph whose edges join exactly those pairs of vertices which belong one to each set. Let P_n be the path with n vertices.

From the definitions, following results are easy.

Proposition 1.1 *Let G be a graph homeomorphic to H (for the definition of homeomorphic, readers are referred to [2]), then $cr(G) = cr(H)$.*

Proposition 1.2 *If G is a subgraph of H , then $cr(G) \leq cr(H)$.*

Proposition 1.3 *If D is a good drawing of a graph G , A , B and C are three mutually disjoint edge subsets of G , then we have*

- (1) $cr_D(A \cup B) = cr_D(A) + cr_D(A, B) + cr_D(B)$;
- (2) $cr_D(A \cup B, C) = cr_D(A, C) + cr_D(B, C)$.

The investigation on the crossing number of graphs is a classical and however very difficult problem. The exact value of the crossing number is known only for few specific families of graphs. The Cartesian product is one of few graph classes, for which exact crossing number results are known. It has long conjectured in [4] that the crossing number $cr(K_{m,n})$ of the complete bipartite graph $K_{m,n}$ equals the Zarankiewicz's Number $Z(m, n) = \lfloor \frac{m}{2} \rfloor \lfloor \frac{m-1}{2} \rfloor \lfloor \frac{n}{2} \rfloor \lfloor \frac{n-1}{2} \rfloor$. (For any real $x, \lfloor x \rfloor$ denotes the maximum integer not greater than x). This conjecture has been verified by Kleitman for $\min\{m, n\} \leq 6$, see [5]. The table in [6] shows the summary of known crossing numbers for Cartesian products of path, cycle and star with connected graphs of order five.

Kulli and Muddebihal [7] gave the Characterization of all pairs of graphs which join is planar graph. In [8] Bogdan Oporowski proved $cr(C_3 \vee C_5) = 6$. In [9] Ling Tang et al. gave the crossing number of the join of C_m and P_n . It thus seems natural to inquire about crossing numbers of join product of graphs. In this paper, we give exact values of crossing numbers for join products $G_i \vee P_n$ for some graphs $G_i (i = 2, 5, 6, 9)$ see Fig.1 of order five in table [6], which is related with parallel bundles on planar map geometries ([10]), a kind of planar Smarandache geometries.

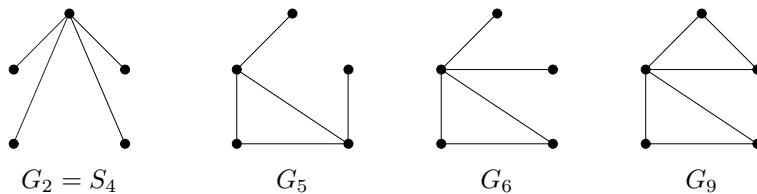

Fig.1

§2. The Crossing Number of $G_2 \vee P_n, G_6 \vee P_n$ and $G_9 \vee P_n$

One of good drawings for graphs $G_2 \vee P_n, G_6 \vee P_n$ and $G_9 \vee P_n$ are shown in Fig.2-Fig.4 following.

A good drawing of $G_2 \vee P_n$

Fig.2

A good drawing of $G_6 \vee P_n$

Fig.3

A good drawing of $G_9 \vee P_n$

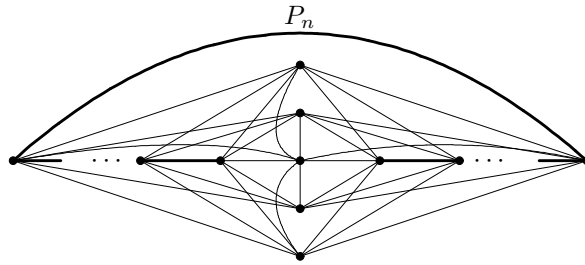
Fig.4

Theorem 2.1 $cr(G_i \vee P_n) = n(n-1)$ ($i = 2, 6, 9$), for $n \geq 1$.

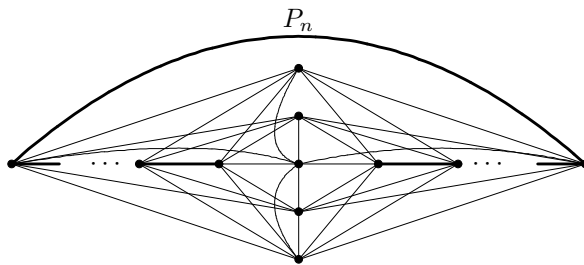
Proof The drawing in Fig.2, Fig.3, Fig.4 following shows that $cr(G_i \vee P_n) \leq Z(5, n) + 2\lfloor \frac{n}{2} \rfloor = 4\lfloor \frac{n}{2} \rfloor \lfloor \frac{n-1}{2} \rfloor + 2\lfloor \frac{n}{2} \rfloor = n(n-1)$ ($i = 2, 6, 9$) (see Fig.2). As G_i contains a subgraph homeomorphic to $K_{1,4,n}$, whose crossing number is $n(n-1)$ (see [11]). So we have $cr(G_i \vee P_n) \geq cr(K_{1,4,n}) = n(n-1)$ ($i = 2, 6, 9$). This complete the proof. \square

§3. The Crossing Number of $G_5 \vee P_n$

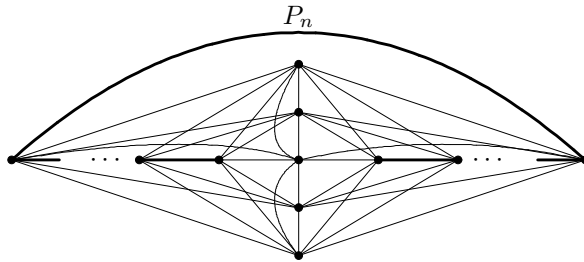
Firstly, let us denote by H_n the graph obtained by adding six edges to the graph $K_{5,n}$, containing

n vertices of degree 5 and two vertices of degree $n + 1$, one vertices of degree $n + 2$, two vertices of degree $n + 3$, and $5n + 6$ edges (see Fig.5). Consider now the graph G_5 in Fig.1. It is easy to see that $H_n = G_5 \cup K_{5,n}$, where the five vertices of degree n in $K_{5,n}$, and the vertices of G_5 are the same. Let, for $i = 1, 2, \dots, n$, T^i denote the subgraph of $K_{5,n}$ which consists of the five edges incident with a vertex of degree five in $K_{5,n}$ (see Fig.6). Thus, we have

$$H_n = G_5 \cup K_{5,n} = G_5 \cup \left(\bigcup_{i=1}^n T^i \right). \tag{1}$$

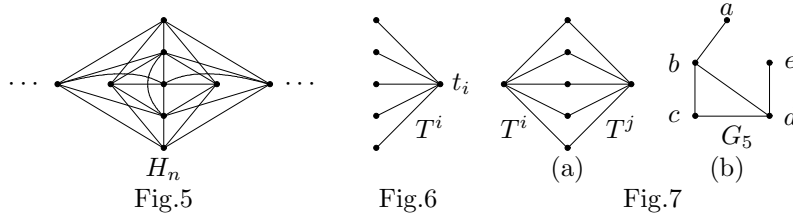

Lemma 3.1 *Let ϕ be a good drawing of H_n , if there exist $1 \leq i \neq j \leq n$, such that $cr_\phi(T^i, T^j) = 0$, then*

$$cr_\phi(G_5, T^i \cup T^j) \geq 1.$$

Proof Let H be the subgraph of H_n induced by the edges of $T^i \cup T^j$. Since $cr_\phi(T^i, T^j) = 0$, and in good drawing two edges incident with the same vertex cannot cross, the subdrawing of $T^i \cup T^j$ induced by ϕ induces the map in the plane without crossing, as shown in Fig.7(a). Let a, b, c, d, e denote the five vertices of the subgraph G_5 (see Fig.7(b)). Clearly, for any $x \in V(G_5)$, there are exactly two other vertices of G_5 on the boundary of common region with x . By $d_{G_5}(b) = 3$, at the edges incident with b , there are at least one crossing with edges of H . Similarly, at the edges incident with d , there are at least one crossing with edges of H . If the two crossings are different, this completes the proof, otherwise, the same crossing can find at edge bd , there are also at least one crossing with edges of H . The proof also holds. Therefore, we complete the proof. \square

Theorem 3.2 $cr(H_n) = Z(5, n) + \lfloor \frac{n}{2} \rfloor, n \geq 1.$

Proof The drawing in Fig.5 shows that

$$cr(H_n) \leq cr(K_{5,n}) + \lfloor \frac{n}{2} \rfloor = Z(5, n) + \lfloor \frac{n}{2} \rfloor.$$

Thus, in order to prove theorem, we need only to prove that $cr_{\phi'}(H_n) \geq Z(5, n) + \lfloor \frac{n}{2} \rfloor$ for any drawing ϕ' of H_n . We prove the reverse inequality by induction on n . The case $n = 1$ is trivial, and the inequality also holds when $n = 2$ since H_2 contains a subgraph homeomorphic to $K_{3,3}$, whose crossing number is 1. Now suppose that for $n \geq 3$,

$$cr(H_{n-2}) \geq Z(5, n - 2) + \lfloor \frac{n-2}{2} \rfloor \tag{2}$$

and consider such a drawing ϕ of H_n that

$$cr_\phi(H_n) < Z(5, n) + \lfloor \frac{n}{2} \rfloor \tag{3}$$

Our next analysis depends on whether or not there are different subgraph T^i and T^j that do not cross each other in ϕ .

Case 1 Suppose that $cr_\phi(T_i, T_j) \geq 1$ for any two different subgraphs T^i and T^j , $1 \leq i \neq j \leq n$. By Proposition 1.3, using (1), we have

$$cr_\phi(H_n) = cr_\phi(K_{5,n}) + cr_\phi(G_5) + cr_\phi(K_{5,n}, G_5) \geq Z(5, n) + cr_\phi(G_5) + \sum_{i=1}^n cr_\phi(G_5, T^i)$$

This, together with our assumption (3), implies that

$$cr_\phi(G_5) + \sum_{i=1}^n cr_\phi(G_5, T^i) < \lfloor \frac{n}{2} \rfloor$$

We can see that in ϕ there are no more than $\lfloor \frac{n}{2} \rfloor$ subgraphs T^i which cross G_5 , and at least have $\lceil \frac{n}{2} \rceil$ subgraphs T^i which does not cross G_5 . Now, we consider T^i , which satisfy $cr_\phi(G_5, T^i) = 0$. Without loss of generality, we suppose $cr_\phi(G_5, T^n) = 0$ and let F be the subgraph $G_5 \cup T^n$ of the graph H_n .

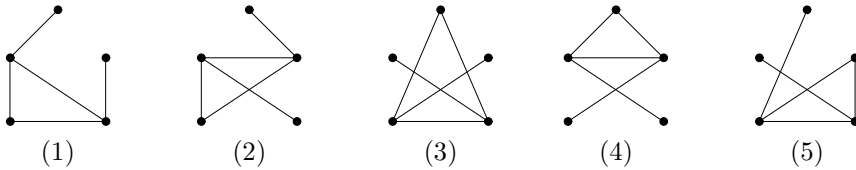
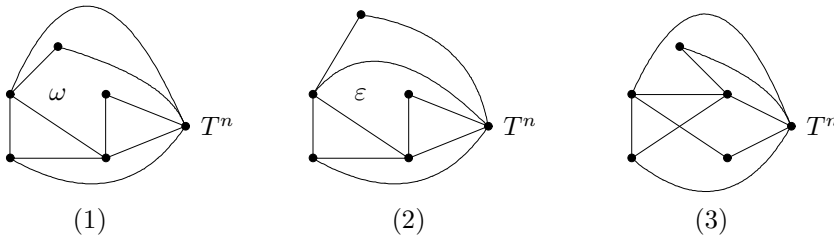

Fig.8

Consider the subdrawings ϕ^* and ϕ^{**} of G_5 and F , respectively, induced by ϕ . Since $cr_\phi(G_5, T^n) = 0$, the subdrawing ϕ^* divides the plane in such a way that all vertices are on the boundary of one region. It is easy to verify that all possibilities of the subdrawing ϕ^* are shown in Fig.8. Thus, all possibilities of the subdrawing ϕ^{**} are shown in Fig.9.



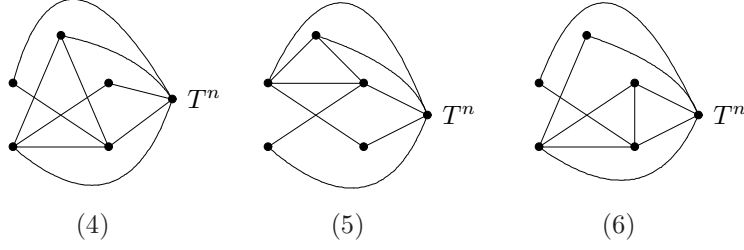

Fig.9

(a) The subdrawing ϕ^{**} of $\langle G_5 \cup T^n \rangle$ is isomorphic to Figure 9(1). When the vertex t_i ($1 \leq i \leq n-1$) locates in the region labeled ω , we have $cr_\phi(T^i, G_5 \cup T^n) \geq 1$, using $cr_\phi(T^i, T^j) \geq 1$, we have $cr_\phi(T^i, G_5 \cup T^n) \geq 2$; when the vertex t_i locates in the other regions, we have $cr_\phi(T^i, G_5 \cup T^n) \geq 3$.

We suppose there are x vertices t_i locates in the region labeled ω , and the other $n-1-x$ vertices locates in the other regions. It has been proved that x is no more than $\lfloor \frac{n}{2} \rfloor$, so by Proposition 1.3, we have

$$\begin{aligned}
 cr_\phi(H_n) &= cr_\phi(G_5 \cup T^n \cup \bigcup_{i=1}^{n-1} T^i) \\
 &= cr_\phi(G_5 \cup T^n, \bigcup_{i=1}^{n-1} T^i) + cr_\phi(G_5 \cup T^n) + cr_\phi(\bigcup_{i=1}^{n-1} T^i) \\
 &\geq Z(5, n-1) + 2x + 3(n-1-x) \\
 &\geq 4\lfloor \frac{n}{2} \rfloor \lfloor \frac{n-1}{2} \rfloor + 3n - 3 - \lfloor \frac{n}{2} \rfloor \\
 &\geq Z(5, n) + \lfloor \frac{n}{2} \rfloor
 \end{aligned}$$

(b) The subdrawing ϕ^{**} of $\langle G_5 \cup T^n \rangle$ is isomorphic to Figure 9(2). When the vertex t_i ($1 \leq i \leq n-1$) locates in the region labeled ε , we have $cr_\phi(T^i, G_5 \cup T^n) \geq 2$; when the vertex t_i locates in the other regions, we have $cr_\phi(T^i, G_5 \cup T^n) \geq 3$. Using the similar way as Fig.9(1), we can have $cr_\phi(H_n) \geq Z(5, n) + \lfloor \frac{n}{2} \rfloor$.

(c) The subdrawing ϕ^{**} of $\langle G_5 \cup T^n \rangle$ is isomorphic to Figure 9(3)-9(6). No matter which region t_i locates in, we have $cr_\phi(T^i, G_5 \cup T^n) \geq 3$. Then by Proposition 1.3, we have

$$\begin{aligned}
 cr_\phi(H_n) &= cr_\phi(G_5 \cup T^n \cup \bigcup_{i=1}^{n-1} T^i) \\
 &= cr_\phi(G_5 \cup T^n, \bigcup_{i=1}^{n-1} T^i) + cr_\phi(G_5 \cup T^n) + cr_\phi(\bigcup_{i=1}^{n-1} T^i) \\
 &\geq Z(5, n-1) + 3(n-1) \\
 &\geq Z(5, n) + \lfloor \frac{n}{2} \rfloor
 \end{aligned}$$

This contradicts (3).

Case 2 Suppose that there are at least two different subgraphs T^i and T^j that do not cross each other in ϕ . Without loss of generality, we may assume that $cr_\phi(T^{n-1}, T^n) = 0$. By Lemma 3.1, $cr_\phi(G_5, T^{n-1} \cup T^n) \geq 1$, as $cr(K_{3,5}) = 4$, for all $i = 1, 2, \dots, n-2$, $cr_\phi(T^i, T^{n-1} \cup T^n) \geq 4$. This implies that

$$cr_\phi(H_{n-2}, T^{n-1} \cup T^n) \geq 4(n-2) + 1 = 4n - 7 \tag{4}$$

As $H_n = H_{n-2} \cup (T^{n-1} \cup T^n)$, using (1),(2) and (4), we have

$$\begin{aligned} cr_\phi(H_n) &= cr_\phi(H_{n-2}) + cr_\phi(T^{n-1} \cup T^n) + cr_\phi(H_{n-2}, T^{n-1} \cup T^n) \\ &\geq 4\lfloor \frac{n-2}{2} \rfloor \lfloor \frac{n-3}{2} \rfloor + \lfloor \frac{n-2}{2} \rfloor + 4n - 7 \\ &= Z(5, n) + \lfloor \frac{n}{2} \rfloor \end{aligned}$$

This contradiction to (3). So the conclusion is held.

This completes the proof of Theorem 3.2. □

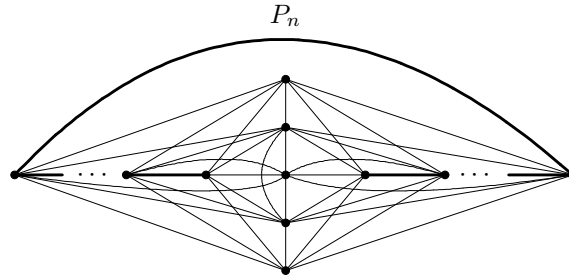

A good drawing of $G_5 \vee P_n$

Fig.10

Theorem 3.3 $cr(G_5 \vee P_n) = Z(5, n) + \lfloor \frac{n}{2} \rfloor$, for $n \geq 1$.

Proof The drawing in Fig.10 shows that $cr(G_5 \vee P_n) \leq Z(5, n) + \lfloor \frac{n}{2} \rfloor$. Contrast Fig.10 with Fig.5, it is easy to check that $G_5 \vee P_n$ has a subgraph which is homeomorphic to H_n , whose crossing number is $Z(5, n) + \lfloor \frac{n}{2} \rfloor$ in Theorem 3.2. So we have $cr(G_5 \vee P_n) \geq cr(H_n) = Z(5, n) + \lfloor \frac{n}{2} \rfloor$.

This completes the proof of Theorem 3.3. □

References

- [1] Jonathan L. Gross, and Thomas W. Tucker, *Topological Graph Theory*, A Wiley-Interscience Publication, John Wiley & Sons, Canada, 1987.
- [2] F. Harary. *Graph Theory*, Addison-Wesley, Reading, MA, 1969.
- [3] J.A.Bondy and U.S.R.Murty, *Graph Theory with Applications*, The Macmillan Press LTD., London,1976.
- [4] Zarankiewicz, K., On a problem of P. Turan concerning graphs, *Fund. Math.* **41**(1954),137-145.

- [5] D.J.Kleitman, The Crossing number of $K_{5,n}$, *J.Combin.Theory B* **9**(1971), 315-323.
- [6] Marián Klešč, The crossing numbers of Cartesian products of paths with 5-vertex graphs, *Discrete Mathematics* **233**(2001), 353-359.
- [7] Kulli, V. R., and M.H.Muddebihal, Characterization of join graphs with crossing number zero, *Far East J. Appl.Math.* **5**(2001), 87-97.
- [8] Bogdan Oporowski and David Zhao, Coloring graphs with crossings, to appear.
- [9] Ling Tang, Jing Wang and Yuanqiu Huang , The Crossing Number of the Join of C_m and P_n , *International J. Mathematical Combinatorics*, Vol.1(2007), No.1, 110-116.
- [10] L.F.Mao, Parallel bundles in planar map geometries, *Scientia Magna*, Vol.1(2005), No.2, 120-133.
- [11] Y.Huang, T.Zhao, The crossing numbers of $K_{1,4,n}$, *Discrete Mathematics* (2007),doi:10.1016/j.and.disc.2006.12.002.
- [12] Y.H.Peng, Y.C.Yiew, The crossing number of $P(3, 1) \times P_n$, *Discrete mathematics* **306**(2006), 1941-1946.

Identities by L-summing Method (II)

Mehdi Hassani

(Department of Mathematics, Institute for Advanced Studies in Basic Sciences, P.O. Box 45195-1159, Zanjan, Iran.)

E-mail: mmhassany@gmail.com

Abstract: In this paper, we introduce 3-dimensional L-summing method by combinatorial speculation ([8]), which is a more complicated version of the usual technique of “changing the order of summation”. Applying this method on some special arrays we obtain identities concerning some special functions, and we get more identities by using a Maple program for this method. Finally, we introduce higher dimensional versions of L-summing method.

Key Words: L-summing method, identity, special function.

AMS(2000): 65B10, 33-XX

§1. Introduction

An identity is a mathematical sentence that has “=” in its middle; Zeilberger [7]. An ancient and well-known proof for the identity

$$\sum_{k=1}^n (2k - 1) = n^2$$

considers an $n \times n$ array of bullets (the total number of which is obviously n^2) as the following figure

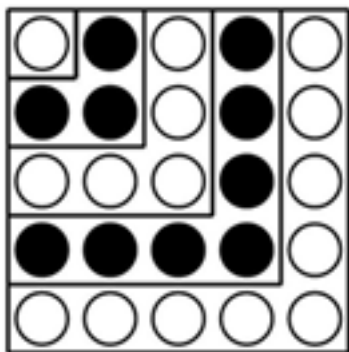

Fig.1

and divides it into n L-shaped zones containing $1, 3, \dots, 2n - 1$ bullets. In Hassani [3] we have generalized this process to all arrays of numbers with two dimension; to explain briefly, we

¹Received March 16, 2008. Accepted April 21, 2008.

consider the following $n \times n$ multiplication table

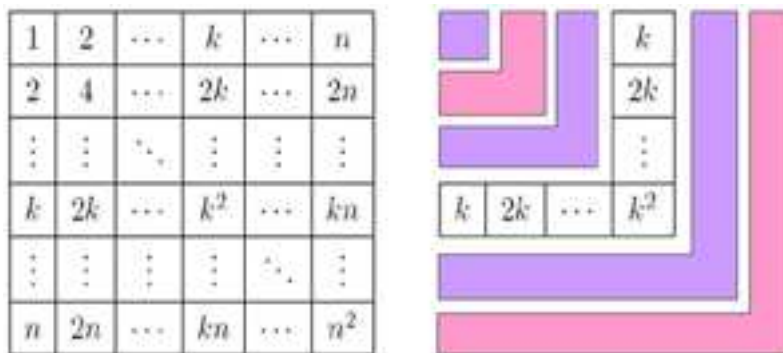

Fig.2

and we set $\Sigma(n)$ for the sum of all numbers in it. By summing line by line and using the identity $1 + 2 + \dots + n = n(n + 1)/2$ we have $\Sigma(n) = (n(n + 1)/2)^2$. On the other hand, letting L_k be the sum of numbers in the rotated L in above table (right part of FIGURE 2), we have

$$L_k = k + 2k + \dots + k^2 + \dots + 2k + k = 2k(1 + 2 + \dots + k) - k^2 = k^3,$$

which gives $\Sigma(n) = \sum_{k=1}^n L_k = \sum_{k=1}^n k^3$, and therefore $\sum_{k=1}^n k^3 = (n(n + 1)/2)^2$. We call L_k , L-summing element and above process is 2-dimensional L-summing method (applied on the array $A_{ab} = ab$). In general, this method is

$$\sum (L - \text{Summing Elements}) = \Sigma. \tag{1}$$

More precisely, the L-summing method of elements of $n \times n$ array A_{ab} with $1 \leq a, b \leq n$, is the following rearrangement

$$\sum_{k=1}^n \left\{ \sum_{a=1}^k A_{ak} + \sum_{b=1}^k A_{kb} - A_{kk} \right\} = \sum_{1 \leq a, b \leq n} A_{ab}.$$

This method allows us to obtain easily some classical algebraic identities and also, with help of Maple, some new compact formulas for sums related with the Riemann zeta function, the gamma function and the digamma function, Gilewicz [2] and Hassani [3].

In this paper we introduce a 3-dimensional version of L-summing method for $n \times n \times n$ arrays and we apply it on some special arrays. Also, we give a Maple program for this method and using it we generate and then prove more identities. Finally, we introduce a further generalization of L-summing method in higher dimension spaces. All of these are applications of the combinatorial speculation. The readers can see in [8] for details.

§2. L-Summing Method in \mathbb{R}^3

Consider a three dimensional array A_{abc} with $1 \leq a, b, c \leq n$ and n is a positive integer. We find an explicit version of the general formulation (1) for this array. The sum of all entries is $\Sigma(n) = \sum_{1 \leq a, b, c \leq n} A_{abc}$. The L-summing elements in this array have the form pictured in Fig.3.

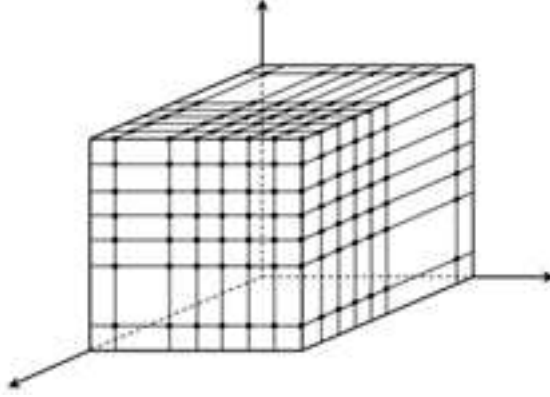

Fig.3

So, we have $L_k = \Sigma_2 - \Sigma_1 + \Sigma_0$, with

$$\begin{aligned}\Sigma_2 &= \sum_{b,c=1}^k A_{kbc} + \sum_{a,c=1}^k A_{akc} + \sum_{a,b=1}^k A_{abk}, \\ \Sigma_1 &= \sum_{a=1}^k A_{akk} + \sum_{b=1}^k A_{kbb} + \sum_{c=1}^k A_{kkc}, \\ \Sigma_0 &= A_{kkk}.\end{aligned}$$

Note that Σ_2 is the sum of entries in three faces, Σ_1 is the sum of entries in three intersected edges and Σ_0 is the end point of all faces and edges. Therefore, L-summing method in \mathbb{R}^3 takes the following formulation

$$\sum_{k=1}^n \{\Sigma_2 - \Sigma_1 + \Sigma_0\} = \Sigma(n). \quad (2)$$

Above equation and its generalization in the last section, rely on the so-called ‘‘Inclusion - Exclusion principal’’.

If the array A_{abc} is symmetric, that is for each permutation $\sigma \in S_3$ it satisfies $A_{abc} = A_{\sigma_a \sigma_b \sigma_c}$, then L-summing elements in \mathbb{R}^3 take the following easier form

$$L_k = 3 \sum_{b,c=1}^k A_{kbc} - 3 \sum_{a=1}^k A_{akk} + A_{kkk}. \quad (3)$$

As examples, we apply his method on two special symmetric arrays, related by the Riemann zeta function and digamma function.

The Riemann zeta function Suppose $s \in \mathbb{C}$ and let $A_{abc} = (abc)^{-s}$. Setting $\zeta_n(s) = \sum_{k=1}^n k^{-s}$, it is clear that

$$\Sigma(n) = \sum_{1 \leq a,b,c \leq n} (abc)^{-s} = \zeta_n^3(s).$$

Since this array is symmetric, considering (3), we have

$$L_k = 3 \frac{\zeta_k^2(s)}{k^s} - 3 \frac{\zeta_k(s)}{k^{2s}} + \frac{1}{k^{3s}}.$$

Using (2) and an easy simplification, yield that

$$\sum_{k=1}^n \frac{\zeta_k^2(s)}{k^s} - \frac{\zeta_k(s)}{k^{2s}} = \frac{\zeta_n^3(s) - \zeta_n(3s)}{3}. \quad (4)$$

Note that if $\Re(s) > 1$, then $\lim_{n \rightarrow \infty} \zeta_n(s) = \zeta(s)$, where $\zeta(s) = \sum_{k=1}^{\infty} n^{-s}$ is the well-known Riemann zeta function defined for complex values of s with $\Re(s) > 1$ and admits a meromorphic continuation to the whole complex plan, Ivić [5]. So, for $\Re(s) > 1$ we have

$$\sum_{k=1}^{\infty} \frac{\zeta_k^2(s)}{k^s} - \frac{\zeta_k(s)}{k^{2s}} = \frac{\zeta^3(s) - \zeta(3s)}{3},$$

which also is true for other values of s by meromorphic continuation, except $s = 1$ and $s = \frac{1}{3}$.

Digamma function Setting $s = 1$ in (??) (or equivalently taking $A_{abc} = \frac{1}{abc}$) and considering $\zeta_n(1) = H_n = \sum_{k=1}^n \frac{1}{k}$, we obtain

$$\sum_{k=1}^n \left\{ \frac{H_k^2}{k} - \frac{H_k}{k^2} \right\} = \frac{H_n^3 - \zeta_n(3)}{3}.$$

We can state this identity in terms of digamma function $\Psi(x) = \frac{d}{dx} \ln \Gamma(x)$, where $\Gamma(x) = \int_0^{\infty} e^{-t} t^{x-1} dt$ is the well-known gamma function. To do this, we use

$$\Psi(n+1) + \gamma = H_n, \quad (5)$$

in which $\gamma = 0.57721\dots$ is the Euler constant; Abramowitz and Stegun [1]. Therefore, we obtain

$$\sum_{k=1}^n \left\{ \frac{(\Psi(k+1) + \gamma)^2}{k} - \frac{\Psi(k+1) + \gamma}{k^2} \right\} = \frac{(\Psi(n+1) + \gamma)^3 - \zeta_n(3)}{3}. \quad (6)$$

Letting

$$\S(m, n) = \sum_{k=1}^n \frac{\Psi(k)^m}{k},$$

the following identity in Hassani [3] is a result of 2-dimensional L-summing method

$$\S(1, n) = \frac{(\Psi(n+1) + \gamma)^2 + \Psi(1, n+1)}{2} - \frac{\pi^2}{12} - \Psi(n+1)\gamma - \gamma^2, \quad (7)$$

where $\Psi(m, x) = \frac{d^m}{dx^m} \Psi(x)$ is called m^{th} polygamma function; Abramowitz and Stegun [1], and we have

$$\zeta_n(s) = \frac{(-1)^{s-1}}{(s-1)!} \Psi(s-1, n+1) + \zeta(s) \quad (s \in \mathbb{Z}, s \geq 2). \quad (8)$$

Using (8) in (4) we can get a generalization of (6), however (6) itself is the key of obtaining an analogue of (7) in \mathbb{R}^3 .

Theorem 1 For every integer $n \geq 1$, we have

$$\begin{aligned} \sum_{k=1}^n \left\{ \frac{\Psi(k)^2}{k} + \frac{\Psi(k)}{k^2} \right\} &= \frac{(\Psi(n+1) + \gamma)^3}{3} - \frac{\zeta_n(3)}{3} + (\gamma - 2) \frac{\pi^2}{6} \\ &- (\gamma - 2) \Psi(1, n+1) - \gamma^2 \Psi(n+1) - \gamma^3 - 2\S(1, n). \end{aligned}$$

Proof We begin from the left hand side of the identity (6), then we simplify it by using the relations $\Psi(n+1) = \frac{1}{n} + \Psi(n)$, (5) and the relation (8) with $s = 2$. This completes the proof. \square

Corollary 2 For every integer $n \geq 1$, we have

$$\begin{aligned} \xi(2, n) &= \frac{(\Psi(n+1) + \gamma)^3}{3} - \frac{\zeta_n(3)}{3} + (\gamma - 2)\frac{\pi^2}{6} - (\gamma - 2)\Psi(1, n+1) \\ &- \gamma^2\Psi(n+1) - \gamma^3 - 2\xi(1, n) - \sum_{k=1}^n \frac{\Psi(k)}{k^2}. \end{aligned}$$

In the above corollary, the main term in the right hand side is $\frac{\Psi(n+1)^3}{3}$. Also, computations show that $\sum_{k=1}^{\infty} \frac{\Psi(k)}{k^2} = 0.252\dots$

Note and Problem 3 Since $\Psi(x) \sim \ln x$, we obtain

$$\xi(m, n) \sim \sum_{k=1}^n \frac{\ln^m k}{k} \sim \int_1^n \frac{\ln^m k}{k} dk = \frac{\ln^{m+1} n}{m+1} \sim \frac{\Psi(n+1)^{m+1}}{m+1}.$$

It is interesting to find an explicit recurrence relation for the function $\xi(m, n)$. One can attack this problem by considering generalization of L-summing method in higher dimension spaces, considered in the last section of this paper.

§3. An Identity - Generator Machine

Based on the formulation of 3-dimensional L-summing method, we can write a Maple program (see Appendix 1), with input a 3-dimensional array A_{abc} , and out put an identity, which we show it by $\text{LSMI} \langle A_{abc} \rangle$. We introduce some examples; the first one is $\text{LSMI} \langle \ln(a) \rangle$, which is

$$\sum_{k=1}^n \{k^2 \ln k + 2k \ln \Gamma(k+1) - 2k \ln k - \ln \Gamma(k+1) + \ln k\} = n^2 \ln \Gamma(n+1).$$

To prove this, we consider relations (2) and $\Gamma(n+1) = n!$, and we obtain $\Sigma(n) = n^2 \sum_{a=1}^n \ln a = n^2 \ln \Gamma(n+1)$. Also, $\Sigma_2 = k^2 \ln k + 2k \ln \Gamma(k+1)$, $\Sigma_1 = \ln \Gamma(k+1) + 2k \ln k$ and $\Sigma_0 = \ln k$.

Breaking up the statement under the sum obtained by $\text{LSMI} \langle \ln(a) \rangle$ into the sum of $(k^2 - k) \ln k + 2k \ln \Gamma(k+1)$ and $\ln \Gamma(k+1) + k \ln k - \ln k$, and considering Proposition 6 of Hassani [3], which states

$$\sum_{k=1}^n \{\ln \Gamma(k+1) + k \ln k - \ln k\} = n \ln \Gamma(n+1),$$

led us to the following result

$$\sum_{k=1}^n \{(k^2 - k) \ln k + 2k \ln \Gamma(k+1)\} = (n^2 + n) \ln \Gamma(n+1). \quad (9)$$

This is an important example, because examining Maple code of expressed sum in (9), we see that Maple has no comment for computing it. But, it is obtained by Maple itself and L-summing method. There is another gap in Maple recognized by this method (see Appendix 2).

As we see, Maple program of 3-dimension L-summing method is a machine of generating identities. Many of them are similar and are not interesting, but we can choose some interesting ones. Another easy example is $\text{LSMI} \langle \tan(a) \rangle$, which (after simplification) is

$$\sum_{k=1}^n \{(k-1)^2 \tan k + (2k-1)\mathfrak{T}(k)\} = n^2 \mathfrak{T}(n),$$

where $\mathfrak{T}(n) = \sum_{k=1}^n \tan k$. Our last example is an identity concerning hypergeometric functions, denoted in Maple by

$$\text{hypergeom}([a_1 \ a_2 \ \cdots \ a_p], [b_1 \ b_2 \ \cdots \ b_q], x).$$

Standard notation and definition; Petkovšek, Wilf and Zeilberger [6], is as follows

$${}_pF_q \left[\begin{matrix} a_1 & a_2 & \cdots & a_p \\ b_1 & b_2 & \cdots & b_q \end{matrix} ; x \right] = \sum_{k \geq 0} t_k x^k,$$

where

$$\frac{t_{k+1}}{t_k} = \frac{(k+a_1)(k+a_2)\cdots(k+a_p)}{(k+b_1)(k+b_2)\cdots(k+b_q)(k+1)} x.$$

Now, setting

$$\mathfrak{H}(\alpha, \beta) = {}_2F_0 \left[\begin{matrix} \alpha & \beta \\ - & \end{matrix} ; 1 \right],$$

after simplification of $\text{LSMI} \langle a! \rangle$ we obtain

$$\sum_{k=1}^n \{(k-1)^2 k! + (2k-1)(k+1)\mathfrak{H}(1, k+2)\} = n^2(n+1)\mathfrak{H}(1, n+2).$$

To prove this, considering definition of hypergeometric functions we have $\mathfrak{H}(1, n+1) = (n+1)\mathfrak{H}(1, n+2)$, which implies $\sum_{a=1}^n a! = \mathfrak{H}(1, 2) - (n+1)\mathfrak{H}(1, n+2) = \mathfrak{P}(n)$, say. This gives $\Sigma(n) = n^2 \mathfrak{P}(n)$ and in similar way it yields that $L_k = (k-1)^2 k! + (2k-1)((k+1)\mathfrak{H}(1, k+2) - \mathfrak{H}(1, 2))$.

Above examples are special cases of the array $A_{abc} = f(a)$, for a given function f . In this general case, L-summing method takes the following formulation

$$\sum_{k=1}^n \{(2k-1)\mathfrak{F}(k) + (k-1)^2 f(k)\} = n^2 \mathfrak{F}(n),$$

where $\mathfrak{F}(n) = \sum_{a=1}^n f(a)$.

§4. Futher Generalizations and Comments

L-summing method in \mathbb{R}^t Consider a t -dimensional array $A_{x_1 x_2 \cdots x_t}$ and let $\Sigma(n) = \sum A_{x_1 x_2 \cdots x_t}$ with $1 \leq x_1, x_2, \cdots, x_t \leq n$. L-summing method in \mathbb{R}^t is the rearrangement $\Sigma(n) = \sum L_k$, where

$$L_k = \sum_{m=1}^t \{(-1)^{m-1} \Sigma_{t-m}\},$$

with

$$\Sigma_{t-m} = \sum_{1 \leq i_1 < i_2 < \dots < i_m \leq t} \left\{ \sum' A_{\mathbf{x}_{i_1 i_2 \dots i_m}} \right\}.$$

The inner sum \sum' is over $x_j \in \{x_{i_1}, \dots, x_{i_m}\}^C = \{x_1, x_2, \dots, x_t\} - \{x_{i_1}, \dots, x_{i_m}\}$ with $1 \leq x_j \leq k$, and the index $\mathbf{x}_{i_1 i_2 \dots i_m}$ denotes $x_1 x_2 \dots x_t$ with $x_{i_1} = x_{i_2} = \dots = x_{i_m} = k$. One can apply this generalized version to get more general form of relations obtained in previous sections. For example, considering the array $A_{x_1 x_2 \dots x_t} = (x_1 x_2 \dots x_t)^{-s}$ with $s \in \mathbb{C}$, yields

$$\sum_{k=1}^n \left\{ \sum_{m=1}^{t-1} (-1)^{m-1} \binom{t}{m} k^{-ms} \zeta_k(s)^{t-m} \right\} = \zeta_n(s)^t + (-1)^t \zeta_n(ts).$$

L-summing method on manifolds. As we told at the beginning, the base of the L-summing method is multiplication table. Above generalization of L-summing method in \mathbb{R}^t is based on the generalized multiplication tables; see Hassani [4]. But, \mathbb{R}^t is a very special t -dimensional manifold, and if we replace it by Γ , an l -dimensional manifold with $l \leq t$, then we can define generalized multiplication table on Γ by considering lattice points on it (which of course isn't easy problem). Let

$$L_\Gamma(n) = \{(a_1, a_2, \dots, a_t) \in \Gamma \cap \mathbb{N}^t : 1 \leq a_1, a_2, \dots, a_t \leq n\},$$

and $f : \mathbb{R}^k \rightarrow \mathbb{C}$ is a function. If \mathcal{O}_Γ is a collection of $k-1$ dimension orthogonal manifolds, in which $L_\Gamma(n) = \cup_{\Lambda \in \mathcal{O}_\Gamma} L_\Lambda(n)$ and $L_{\Lambda_i}(n) \cap L_{\Lambda_j}(n) = \phi$ for distinct $\Lambda_i, \Lambda_j \in \mathcal{O}_\Gamma$, then we can formulate L-summing method as follows

$$\sum_{X \in L_\Gamma(n)} f(X) = \sum_{\Lambda \in \mathcal{O}_\Gamma} \left\{ \sum_{X \in L_\Lambda(n)} f(X) \right\}.$$

Here L-summing elements are $\sum_{X \in L_\Lambda(n)} f(X)$. This may ends to some interesting identities, provided one applies it on some suitable manifolds.

Stronger form of L-summing method. One can state the relation $\sum L_k = \Sigma(n)$ in the following stronger form

$$L_n = \Sigma(n) - \Sigma(n-1).$$

Specially, this will be useful for those arrays with $\Sigma(n)$ computable explicitly and L_k maybe note. For example, considering the array $A_{x_1 x_2 \dots x_t} = (x_1 x_2 \dots x_t)^{-s}$ we obtain

$$\sum_{m=1}^{t-1} (-1)^{m-1} \binom{t}{m} n^{-ms} \zeta_n(s)^{t-m} = \zeta_n(s)^t + (-1)^t \zeta_n(ts) - \zeta_{n-1}(s)^t - (-1)^t \zeta_{n-1}(ts).$$

Acknowledgment. Thanks to Z. Jafari for introducing me some comments.

References

- [1] M. Abramowitz and I.A. Stegun, *Handbook of Mathematical Functions: with Formulas, Graphs, and Mthematical Tables*, Dover Publications, 1972.
Available at: <http://www.convertit.com/Go/ConvertIt/Reference/AMS55.ASP>

- [2] Jacek Gilewicz (Reviewer), Review of the paper [3] (in this reference list), *Zentralblatt MATH Database*, European Mathematical Society, FIZ Karlsruhe & Springer-Verlag, 2007.
- [3] M. Hassani, Identities by L-summing Method, *Int. J. Math. Comp. Sci.*, Vol. 1 (2006) no. 2, 165-172.
- [4] M. Hassani, Lattice Points and Multiplication Tables, *Int. J. Contemp. Math. Sci.*, Vol. 1 (2006) no. 1, 1-2.
- [5] Aleksandar Ivić, *The Riemann Zeta Function*, John Wiley & sons, 1985.
- [6] M. Petkovšek, H.S. Wilf and D. Zeilberger, *A = B*, A. K. Peters, 1996.
Available at: <http://www.cis.upenn.edu/wilf/AeqB.html>
- [7] D. Zeilberger, Identities In Search of Identity, *J. Theoretical Computer Science*, **117** (1993), 23-38.
- [8] L.F.Mao, Combinatorial speculation and combinatorial conjecture for mathematics, *International J.Math. Combin.*, Vol.1(2007), NO.1,1-19.

Appendix 1. Maple program of 3-dimension L -summing method for the array $A_{abc} = \frac{1}{abc}$

```
restart:
A[abc]:=1/(a*b*c);
S21:=sum(sum(eval(A[abc],a=k),b=1..k),c=1..k):
S22:=sum(sum(eval(A[abc],b=k),a=1..k),c=1..k):
S23:=sum(sum(eval(A[abc],c=k),a=1..k),b=1..k):
S2:=S21+S22+S23:
S11:=sum(eval(eval(A[abc],a=k),b=k),c=1..k):
S12:=sum(eval(eval(A[abc],a=k),c=k),b=1..k):
S13:=sum(eval(eval(A[abc],b=k),c=k),a=1..k):
S1:=S11+S12+S13:
S0:=eval(eval(eval(A[abc],a=k),b=k),c=k):
L[k]:=simplify(S2-S1+S0):
ST(A):=(simplify(sum(sum(sum(A[abc],a=1..n),b=1..n),c=1..n))):
Sum(L[k],k=1..n)=ST(A);
```

Appendix 2. A note on the operator “is” in Maple

The operator “is” in Maple software verifies the numerical and symbolic identities and inequalities, and it’s out put is “true”, “false” or “FAIL”. We consider the following example, with “FAIL” as out put.

```
A:=binomial(2*k+1,k+1)+binomial(2*k+1,k)-binomial(2*k,k):
is(sum(A,k = 1 .. n) = binomial(2*n+2,n+1)-2);
```

This example is verifying the following identity:

$$\sum_{k=1}^n \left\{ \binom{2k+1}{k} + \binom{2k+1}{k+1} - \binom{2k}{k} \right\} = \binom{2n+2}{n+1} - 2,$$

which is true by using Maple and L-summing method; Hassani [3].

On the Basis Number of the Direct Product of Theta Graphs with Cycles

^{1,2}M.M.M. Jaradat and ¹K.M.A.Al-Shorman

¹Department of Mathematics of Yarmouk University, Irbid-Jordan

²Department of Mathematics and Physics of Qatar University, Doha-Qatar

E-mail: mmjst4@yu.edu.jo, mmjst4@qu.edu.qa

Abstract: The basis number of a graph G is defined to be the least integer d such that there is a cycle basis, \mathcal{B} , of the cycle space of G such that each edge of G is contained in at most d members of \mathcal{B} . MacLane [11] proved that a graph G is planar if and only if $b(G) \leq 2$. Jaradat [5] proved that the basis number of the direct product of a bipartite graph H with a cycle C is bounded above by $3 + b(H)$. In this work, we show that the basis number of the direct product of a theta graph with a cycle is 3 or 4. Our result, improves Jaradat's upper bound in the case that H is a theta graph containing no odd cycle by a combinatorial approach.

Key Words: cycle space; basis number; cycle basis; direct product.

AMS(2000): 05C38, 05C75.

§1. Introduction

In graph theory, there are many numbers that give rise to a better understanding and interpretation of the geometric properties of a given graph such as the crossing number, the thickness, the genus, the basis number, etc.. The basis number of a graph is of a particular importance because MacLane, in [11], made a connection between the basis number and the planarity of a graph, which is related with parallel bundles on planar map geometries, a kind of Smarandache geometries; in fact, he proved that a graph is planar if and only if its basis number is at most 2.

In general, required cycle bases is not very well behaved under graph operations. That is the basis number $b(G)$ of a graph G is not monotonic (see [2] and [11]). Hence, there does not seem to be a general way of extending required cycle bases of a certain collection of partial graphs of G to a required cycle basis of G , respectively. Global upper bound $b(G) \leq 2\gamma(G) + 2$ where $\gamma(G)$ is the genus of G is proven in [12].

In this paper, we investigate the basis number for the direct product of a theta graphs with cycles.

¹Received February 15, 2008. Accepted April 24, 2008.

§2. Introduction

Unless otherwise specified, the graphs considered in this paper are finite, undirected, simple and connected. For a given graph G , we denote the vertex set of G by $V(G)$ and the edge set by $E(G)$.

Cycle Bases

For a given graph G , the set \mathcal{E} of all subsets of $E(G)$ forms an $|E(G)|$ -dimensional vector space over Z_2 with vector addition $X \oplus Y = (X \setminus Y) \cup (Y \setminus X)$ and scalar multiplication $1 \cdot X = X$ and $0 \cdot X = \emptyset$ for all $X, Y \in \mathcal{E}$. The cycle space, $\mathcal{C}(G)$, of a graph G is the vector subspace of $(\mathcal{E}, \oplus, \cdot)$ spanned by the cycles of G . Note that the non-zero elements of $\mathcal{C}(G)$ are cycles and edge disjoint union of cycles. It is known that for a connected graph G the dimension of the cycle space is the *cyclomatic number* or the *first Betti number*

$$\dim \mathcal{C}(G) = |E(G)| - |V(G)| + r \quad (1)$$

where r is the number of components in G .

A basis \mathcal{B} for $\mathcal{C}(G)$ is called a *cycle basis* of G . A cycle basis \mathcal{B} of G is called a d -fold if each edge of G occurs in at most d of the cycles in \mathcal{B} . The *basis number*, $b(G)$, of G is the least non-negative integer d such that $\mathcal{C}(G)$ has a d -fold basis. The following result will be used frequently in the sequel.

Theorem 2.1.1.(MacLane). *The graph G is planar if and only if $b(G) \leq 2$.*

The following theorem due to Schmeichel, which proves the existence of graphs that have arbitrary large basis number.

Theorem 2.1.2. (Schmeichel) *For any positive integer r , there exists a graph G with $b(G) \geq r$.*

Products

Many authors studied the basis number of graph products. The Cartesian product, \square , was studied by Ali and Marougi [3] and Alsardary and Wojciechowski [4].

Theorem 2.2.1. (Ali and Marougi) *If G and H are two connected disjoint graphs, then $b(G \square H) \leq \max \{ b(G) + \Delta(T_H), b(H) + \Delta(T_G) \}$ where T_H and T_G are spanning trees of H and G , respectively, such that the maximum degrees $\Delta(T_H)$ and $\Delta(T_G)$ are minimum with respect to all spanning trees of H and G .*

Theorem 2.2.2.(Alsardary and Wojciechowski) *For every $d \geq 1$ and $n \geq 2$, we have $b(K_n^d) \leq 9$ where K_n^d is a d times Cartesian product of the complete graph K_n .*

An upper bound on the strong product \boxtimes was obtained by Jaradat [9] when he gave the following result:

Theorem 2.2.3.(Jaradat) *Let G be a bipartite graph and H be a graph. Then $b(G \boxtimes H) \leq \max \left\{ b(H) + 1, 2\Delta(H) + b(G) - 1, \left\lfloor \frac{3\Delta(T_G)+1}{2} \right\rfloor, b(G) + 2 \right\}$.*

The lexicographic product, $G[H]$, was studied by Jaradat and Al-zoubi [8] and Jaradat [10]. They obtained the following result results:

Theorem 2.2.4.(Jaradat and Al-Zoubi) *For each two connected graphs G and H , $b(G[H]) \leq \text{Max}\{4, 2\Delta(G) + b(H), 2 + b(G)\}$.*

Theorem 2.2.5.(Jaradat) *Let G, T_1 and T_2 be a graph, a spanning tree of G and a tree, respectively. Then, $b(G[T_2]) \leq b(G[H]) \leq \max \{5, 4 + 2\Delta(T_{\min}^G) + b(H), 2 + b(G)\}$ where T^G stands for the complement graph of a spanning tree T in G and T_{\min} stands for a spanning tree for G such that $\Delta(T_{\min}^G) = \min \{ \Delta(T^G) | T \text{ is a spanning tree of } G \}$.*

Schmeichel [12], Ali [1], [2] and Jaradat [5] gave an upper bound for the basis number on the semi-strong product \bullet and the direct product, \times , of some special graphs. They proved the following results:

Theorem 2.2.6. (Schmeichel) *For each $n \geq 7$, $b(K_n \bullet P_2) = 4$.*

Theorem 2.2.7.(Ali) *For each integers n, m , $b(K_m \bullet K_n) \leq 9$.*

Theorem 2.2.8. (Ali) *For any two cycles C_n and C_m with $n, m \geq 3$, $b(C_n \times C_m) = 3$.*

Theorem 2.2.9.(Jaradat) *For each bipartite graphs G and H , $b(G \times H) \leq 5 + b(G) + b(H)$.*

Theorem 2.2.10. (Jaradat) *For each bipartite graph G and cycle C , $b(G \times C) \leq 3 + b(G)$.*

We remark that knowing the number of components in a graph is very important to find the dimension of the cycle space as in (1), so we need the following result.

Theorem 2.2.11.([5]) *Let G and H be two connected graphs. Then $G \times H$ is connected if and only if at least one of them contains an odd cycle. Moreover, If both of them are bipartite graphs, then $G \times H$ consists of two components.*

For completeness, we recall that for two graphs G and H , the direct product $G \times H$ is the graph with the vertex set $V(G \times H) = V(G) \times V(H)$ and the edge set $E(G \times H) = \{(u_1, u_2)(v_1, v_2) | u_1v_1 \in E(G) \text{ and } u_2v_2 \in E(H)\}$.

In the rest of this paper, $f_B(e)$ stand for the number of elements of B containing the edge e where $B \subseteq \mathcal{C}(G)$.

§3. The Basis number of $\theta_n \times C_m$.

By specializing bipartite graph G in Theorem 2.2.10 into a theta graph θ_n containing no odd cycles, we have that $b(\theta_n \times C_m) \leq 5$. In this paper, we reduce the upper bound to 4. In fact, we prove that the basis number of the direct product of a theta graph with a cycle is either

3 or 4. Throughout this work we assume that $\{1, 2, \dots, n\}$ and $\{1, 2, \dots, m\}$ to be the vertex sets of θ_n and C_m , respectively.

Definition 3.1. A theta graph θ_n is defined to be a cycle C_n to which we add a new edge that joins two non-adjacent vertices. We may assume 1 and δ are the two vertices of θ_n of degree 3.

The following result follows from Theorem 2.2.11 and noting that at least one of θ_n and C_m contains an odd cycle if and only if at least one of n, m , and δ is odd.

Lemma 3.2. Let θ_n be a theta graph and C_m be a cycle. $\theta_n \times C_m$ is connected if and only if at least one of n, m , and δ is odd, otherwise it consists of two components.

Note that $|E(\theta_n \times C_m)| = 2nm + 2m$ and $|V(\theta_n \times C_m)| = nm$. Hence, by the above lemma and equation (1), we have

$$\dim \mathcal{C}(\theta_n \times C_m) = nm + 2m + s,$$

where

$$s = \begin{cases} 1, & \text{if } \theta_n \times C_m \text{ is connected,} \\ 2, & \text{if } \theta_n \times C_m \text{ is disconnected.} \end{cases}$$

Lemma 3.3. Let θ_n be a theta graph and C_m be a cycle. Then $b(\theta_n \times C_m) \geq 3$.

Proof Note that $\theta_n \times C_m$ contains at most 4 cycles of length 3 and the other cycles are of length at least 4. Assume that $\theta_n \times C_m$ has a 2-fold basis \mathcal{B} . Then

$$\begin{aligned} 2(|E(\theta_n \times C_m)|) &\geq \sum_{C \in \mathcal{B}} |C| \\ &\geq 4(\dim \mathcal{C}(\theta_n \times C_m) - 4) + 3(4) \\ &\geq 4(\dim \mathcal{C}(\theta_n \times C_m) - 1), \end{aligned}$$

and so,

$$\begin{aligned} \frac{2(2nm + 2m)}{4} &\geq nm + 2m + s - 1 \\ nm + m &\geq nm + 2m + s - 1, \end{aligned}$$

where s is as above. Thus,

$$1 \geq m + s.$$

This is a contradiction. □

Lemma 3.4. For any graph θ_n of order $n \geq 4$ and cycle C_m of order $m \geq 3$, we have $b(\theta_n \times C_m) \leq 4$.

Proof To prove the lemma, it is sufficient to exhibit a 4-fold basis, \mathcal{B} , for $\mathcal{C}(\theta_n \times C_m)$. According to the parity of m, n and δ (odd or even), we consider the following eight cases:

Case 1. m and n are even and δ is odd. Then, for each $j = 1, 2, \dots, m-2$, we consider the following sets of cycles:

$$\begin{aligned} A_1^{(j)} &= \{(i, j)(i+1, j+1)(i, j+2)(i-1, j+1)(i, j) : i = 2, 3, \dots, n-1\} \\ &\cup \{(1, j)(2, j+1)(1, j+2)(n, j+1)(1, j)\} \\ &\cup \{(n, j)(n-1, j+1)(n, j+2)(1, j+1)(n, j)\}, \end{aligned}$$

$$\begin{aligned} A_2^{(j)} &= \{(1, j)(2, j+1)(1, j+2)(\delta, j+1)(1, j)\}, \\ A_3^{(j)} &= \{(\delta, j)(\delta-1, j+1)(\delta, j+2)(1, j+1)(\delta, j)\}. \end{aligned}$$

Also, we define the following cycles:

$$\begin{aligned} c_1 &= (1, 1)(2, 2)(3, 1) \dots (n, 2)(1, 1), \\ c_2 &= (1, 2)(2, 1)(3, 2) \dots (n, 1)(1, 2), \\ c_3 &= (1, m)(2, m-1)(3, m) \dots (\delta, m)(1, m-1) \\ &\quad (2, m) \dots (\delta, m-1)(1, m). \end{aligned}$$

Note that, the cycles of $A_1^{(j)}$ are edge pairwise disjoint for each $j = 1, 2, 3, \dots, m-2$. Thus, $A_1^{(j)}$ is linearly independent and of 1-fold. Let $A_1 = \bigcup_{j=1}^{m-2} A_1^{(j)}$. Note that, each cycle of $A_1^{(j)}$ contains an edge of the form $(i+1, j+1)(i, j+2)$ or $(n-1, j+1)(n, j+2)$ which is not in $A_1^{(j-1)}$. In addition, each cycle of $A_1^{(j-1)}$ contains an edge of the form $(i, j-1)(i+1, j)$ or $(n, j)(n-1, j+1)$ which is not in $A_1^{(j)}$. Therefore, A_1 is linearly independent. Let $V_1' = \{(i, j) : i+j = \text{even}\}$, and $V_2' = \{(i, j) : i+j = \text{odd}\}$. Let H_k be the induced subgraph of V_k' where $k = 1, 2$. For each $j = 1, 2, \dots, m-2$, set

$$\begin{aligned} B_1^{(j)} &= \{(i, j)(i+1, j+1)(i, j+2)(i-1, j+1)(i, j) \mid 2 \leq i \leq n-1 \text{ and} \\ i+j &= \text{even}\} \cup \{(1, j)(2, j+1)(1, j+2)(n, j+1)(1, j) : 1+j = \text{even}\} \\ &\cup \{(n, j)(n-1, j+1)(n, j+2)(1, j+1)(n, j) : n+j = \text{even}\}, \\ B_2^{(j)} &= \{(i, j)(i+1, j+1)(i, j+2)(i-1, j+1)(i, j) \mid 2 \leq i \leq n-1 \text{ and} \\ i+j &= \text{odd}\} \cup \{(1, j)(2, j+1)(1, j+2)(n, j+1)(1, j) : 1+j = \text{odd}\} \\ &\cup \{(n, j)(n-1, j+1)(n, j+2)(1, j+1)(n, j) : n+j = \text{odd}\}. \end{aligned}$$

Let $F^{(k)} = \bigcup_{j=1}^{m-2} B_k^{(j)}$ where $k = 1, 2$. We prove that c_k is independent from the cycles of $F^{(k)}$. Let $E_j^{(k)} = E(C_n \times j(j+1)) \cap E(H_k)$ where C_n is the cycle in θ_n obtained by deleting the edge 1δ from θ_n . Then it is an easy matter to verify that $\{E_1^{(k)}, E_2^{(k)}, \dots, E_{m-1}^{(k)}\}$ is a partition of $E(C_n \times P_m) \cap E(H_k)$ where P_m is the path of C_m obtained by deleting the edge $1m$. Moreover, it is clear that $E_1^{(k)} = E(c_k)$ and $E_1^{(k)} \cup E_2^{(k)} = E(B_k^{(1)})$. Thus, if c_k is a sum modulo 2 of some cycles of $F^{(k)}$, say $\{T_1, T_2, \dots, T_r\}$, then $B_k^{(1)} \subseteq \{T_1, T_2, \dots, T_r\}$.

Since no edges in $E_2^{(k)}$ belongs to $E(c_k)$ and $E_2^{(k)} \cup E_3^{(k)} = E(B_k^{(2)})$, $B_k^{(2)} \subseteq \{T_1, T_2, \dots, T_r\}$. By continuing in this way, it implies that $B_k^{(m-2)} \subseteq \{T_1, T_2, \dots, T_r\}$. Note that $E_{m-2}^{(k)} \cup E_{m-1}^{(k)} = E(B_k^{(m-2)})$ and each edge of $E_{m-1}^{(k)}$ appears in one and only one cycle of $F^{(k)}$. It follows that $E_{m-1}^{(k)} \subseteq E(c_k)$. This is a contradiction. Therefore, $F^{(k)} \cup \{c_k\}$ is linearly independent for $k = 1, 2$. And since $E(F^{(1)} \cup \{c_1\}) \cap E(F^{(2)} \cup \{c_2\}) = \phi$, we have $F^{(1)} \cup F^{(2)} \cup \{c_1, c_2\} = A_1 \cup \{c_1, c_2\}$ is linearly independent. Let $A_2 = \bigcup_{j=1}^{m-2} A_2^{(j)}$ and $A_3 = \bigcup_{j=1}^{m-2} A_3^{(j)}$. It is easy to see that the cycles of A_i are edge pairwise disjoint for $i = 2, 3$ and each cycle of A_3 contains at least one edge of the form $(\delta, j)(\delta - 1, j + 1)$ and $(\delta, j)(\delta - 1, j - 1)$ which is not in A_2 . And so $A_2 \cup A_3$ is linearly independent. Clearly, c_3 can not be written as a linear combination of cycles of $A_2 \cup A_3$. Therefore, $A_2 \cup A_3 \cup \{c_3\}$ is linearly independent. Let $B_1 = A_1 \cup A_2 \cup A_3 \cup \{c_1, c_2, c_3\}$. We now prove that B_1 is a linearly independent set. Note that $E(A_2 \cup A_3 \cup \{c_3\}) - \{(1, j)(\delta, j + 1), (1, j + 1)(\delta, j) \mid 1 \leq j \leq m - 1\}$ forms an edge set of a forest. Thus, any linear combinations of cycles of $A_2 \cup A_3 \cup \{c_3\}$ must contains at least one edge of the form $(1, j)(\delta, j + 1)$ and $(1, j + 1)(\delta, j)$ for some $j \leq m - 1$ because any linear combination of a linearly independent set of cycles is a cycle or an edge disjoint union of cycles. Now, Suppose that there are two sets of cycles say $\{d_1, d_2, \dots, d_{\gamma_1}\} \subseteq A_1 \cup \{c_1, c_2\}$ and $\{f_1, f_2, \dots, f_{\gamma_2}\} \subseteq A_2 \cup A_3 \cup \{c_3\}$ such that $\sum_{i=1}^{\gamma_1} d_i = \sum_{i=1}^{\gamma_2} f_i \pmod{2}$. Consequently, $E(d_1 \oplus d_2 \oplus \dots \oplus d_{\gamma_1}) = E(f_1 \oplus f_2 \oplus \dots \oplus f_{\gamma_2})$ and so $d_1 \oplus d_2 \oplus \dots \oplus d_{\gamma_1}$ contains at least one edge of the form $(1, j)(\delta, j + 1)$ and $(1, j + 1)(\delta, j)$ for some $j \leq m - 1$, which contradicts the fact that no cycle of $A_1 \cup \{c_1, c_2\}$ contains such edges. We now define the following sets of cycles

$$\begin{aligned} A_4 &= \{A_4^{(i)} = (i + 1, 1)(i + 2, 2)(i + 1, 3) \dots (i + 2, m)(i + 1, 1) : i = 0, 1, \\ &\quad \dots, n - 2\}, \\ A_5 &= \left\{ A_5^{(i)} = (i + 1, 1)(i, 2)(i + 1, 3) \dots (i, m)(i + 1, 1) : i = 1, 2, \dots, n - 1 \right\}, \end{aligned}$$

and

$$\begin{aligned} c'_1 &= (\delta, 1)(\delta + 1, 2)(\delta, 3)(\delta + 1, 4) \dots (\delta, m - 1)(1, m)(\delta, 1), \\ c'_2 &= (1, 1)(2, m)(3, 1)(4, m) \dots (\delta, 1)(1, m)(2, 1) \dots (\delta, m)(1, 1), \\ c'_3 &= (1, 1)(n, 2)(1, 3)(n, 4) \dots (n, m)(1, 1), \\ c'_4 &= (n, 1)(1, 2)(n, 3)(1, 4) \dots (1, m)(n, 1). \end{aligned}$$

Let $D = A_4 \cup A_5 \cup \{c'_1, c'_2, c'_3, c'_4\}$. Each cycle $A_4^{(i)}$ of A_4 contains the edge $(i + 2, m)(i + 1, 1)$ which belongs to no other cycles of $B_1 \cup A_4$. Thus $B_1 \cup A_4$ is linearly independent. Similarly, each cycle $A_5^{(i)}$ of A_5 contains the edge $(i, m)(i + 1, 1)$ which belongs to no other cycles of $B_1 \cup A_4 \cup A_5$. Hence $B_1 \cup A_4 \cup A_5$ is linearly independent. Now c'_1 is the only cycle of $B_1 \cup A_4 \cup A_5 \cup \{c'_1\}$ which contains the edge $(1, m)(\delta, 1)$. Hence $B_1 \cup A_4 \cup A_5 \cup \{c'_1\}$ is linearly independent. Similarly, c'_2 is the only cycle of $B_1 \cup A_4 \cup A_5 \cup \{c'_1, c'_2\}$ which contains the edge $(\delta, m)(1, 1)$. Thus $B_1 \cup A_4 \cup A_5 \cup \{c'_1, c'_2\}$ is linearly independent. Now, c'_3 and c'_4 contain

$(1, 1)(n, m)$ and $(1, m)(n, 1)$, respectively, which appear in no cycle of $B_1 \cup A_4 \cup A_5 \cup \{c'_1, c'_2\}$. Therefore, $\mathcal{B} = B_1 \cup D$ is linearly independent. Now,

$$\begin{aligned}
|\mathcal{B}| &= \sum_{i=1}^5 |A_i| + \sum_{i=1}^3 |c_i| + \sum_{i=1}^4 |c'_i| \\
&= n(m-2) + (m-2) + (m-2) + (n-1) + (n-1) + 3 + 4 \\
&= nm + 2m + 1 \\
&= \dim \mathcal{C}(\theta_n \times C_m).
\end{aligned}$$

Hence, \mathcal{B} is a basis of $\theta_n \times C_m$. To complete the proof of this case, we only need to prove that \mathcal{B} is a 4-fold basis. For simplicity, set $Q = \cup_{i=1}^3 \{c_i\}$. Let $e \in E(\theta_n \times C_m)$. Then

(1) If $e = (i, j)(i+1, j+1)$ or $(n, j)(1, j+1)$ where $1 \leq i \leq n-1$, and $2 \leq j \leq m-2$, then $f_{A_1}(e) = 2$, $f_{A_2 \cup A_3}(e) \leq 1$, $f_D(e) \leq 1$, and $f_Q(e) = 0$, and so $f_{\mathcal{B}}(e) \leq 4$.

(2) If $e = (i, j)(i+1, j-1)$ or $(n, j)(1, j-1)$ where $1 \leq i \leq n-1$, and $3 \leq j \leq m-1$, then $f_{A_1}(e) = 2$, $f_{A_2 \cup A_3}(e) \leq 1$, $f_D(e) \leq 1$, and $f_Q(e) = 0$, and so $f_{\mathcal{B}}(e) \leq 4$.

(3) If $e = (i, 1)(i+1, 2)$ or $(1, 1)(n, 2)$, where $1 \leq i \leq n-1$, then $f_{A_1}(e) = 1$, $f_{A_2 \cup A_3}(e) \leq 1$, $f_D(e) \leq 1$, and $f_Q(e) \leq 1$, and so $f_{\mathcal{B}}(e) \leq 4$.

(4) If $e = (i, 2)(i+1, 1)$ or $(1, 2)(n, 1)$ where $1 \leq i \leq n-1$, then $f_{A_1}(e) = 1$, $f_{A_2 \cup A_3}(e) \leq 1$, $f_D(e) \leq 1$, and $f_Q(e) = 1$, and so $f_{\mathcal{B}}(e) \leq 4$.

(5) If $e = (1, j)(\delta, j+1)$ where $1 \leq j \leq m-2$, then $f_{A_1}(e) = 0$, $f_{A_2 \cup A_3}(e) \leq 2$, $f_D(e) = 1$, and $f_Q(e) = 0$, and so $f_{\mathcal{B}}(e) \leq 3$.

(6) If $e = (1, j)(\delta, j-1)$ where $2 \leq j \leq m-2$, then $f_{A_1}(e) = 0$, $f_{A_2 \cup A_3}(e) \leq 2$, $f_D(e) = 1$, and $f_Q(e) = 0$, and so $f_{\mathcal{B}}(e) \leq 3$.

(7) If $e = (i, m-1)(i+1, m)$ or $(i, m)(i+1, m-1)$ or $(1, m)(n, m-1)$ where $1 \leq i \leq n-1$, then $f_{A_1}(e) = 1$, $f_{A_2 \cup A_3}(e) \leq 1$, $f_D(e) \leq 1$, and $f_Q(e) \leq 1$, and so $f_{\mathcal{B}}(e) \leq 4$.

(8) If $e = (1, m)(\delta, m-1)$ or $(1, m-1)(\delta, m)$, then $f_{A_1}(e) = 0$, $f_{A_2 \cup A_3}(e) \leq 1$, $f_D(e) \leq 1$, and $f_Q(e) \leq 1$, and so $f_{\mathcal{B}}(e) \leq 3$.

(9) If $e = (i+1, 1)(i, m)$ or $(i, 1)(i+1, m)$, where $1 \leq i \leq n-1$, then $f_{A_1}(e) = 0$, $f_{A_2 \cup A_3}(e) = 0$, $f_D(e) \leq 2$, and $f_Q(e) \leq 1$, and so $f_{\mathcal{B}}(e) \leq 3$.

(10) If $e = (1, 1)(\delta, m)$ or $(1, m)(\delta, 1)$, then $f_{A_1}(e) = 0$, $f_{A_2 \cup A_3}(e) = 0$, $f_D(e) \leq 2$, and $f_Q(e) = 0$, and so $f_{\mathcal{B}}(e) \leq 2$.

(11) If $e = (1, 1)(n, m)$ or $(n, 1)(1, m)$, then $f_{A_1}(e) = 0$, $f_{A_2 \cup A_3}(e) = 0$, $f_D(e) \leq 1$, and $f_Q(e) = 0$, and so $f_{\mathcal{B}}(e) \leq 1$. Therefore \mathcal{B} is a 4-fold basis. The proof of this case is complete.

Case 2. m and δ are even and n is odd. Now, consider the following sets of cycles: A_1 , A_2 and A_3 are as in Case 1 and

$$\begin{aligned}
c_1 &= (1, m) (2, m-1) (3, m) \dots (\delta, m-1) (1, m), \\
c_2 &= (1, m-1) (2, m) (3, m-1) \dots (\delta, m) (1, m-1), \\
c_3 &= (1, 1) (2, 2) (3, 1) \dots (n, 1) (1, 2) (2, 1) \dots (n, 2) (1, 1).
\end{aligned}$$

Let $B_1 = (\cup_{i=1}^3 A_i) \cup (\cup_{i=1}^3 \{c_i\})$. Since $E(c_1) \cap E(c_2) = \emptyset$, $\{c_1, c_2\}$ is linearly independent. Since $\delta \geq 4$, c_1 contains an edge of the form $(2, m-1) (3, m)$ and c_2 contains an edge of the form $(2, m) (3, m-1)$ and each of which does not appear in any cycles of $A_2 \cup A_3$. Thus $A_2 \cup A_3 \cup \{c_1, c_2\}$ is linearly independent. Next, we show that $A_1 \cup \{c_3\}$ is linearly independent. Let $R_i = E(C_n \times i(i+1))$ where C_n is as in Case 1. Note that $\{R_1, R_2, \dots, R_{m-1}\}$ is a partition of $E(C_n \times P_m)$ where P_m is as in Case 1. Also, $E(c_3) = R_1$ and $R_1 \cup R_2 = E(A_1^{(1)})$. Thus, if c_3 can be written as linear combination of some cycles of A_1 , say $\{K_1, K_2, \dots, K_r\}$, then $A_1^{(1)} \subseteq \{K_1, K_2, \dots, K_r\}$. Since $R_2 \cup R_3 = E(A_1^{(2)})$ and no edges of R_2 belongs to $E(c_3)$, $A_1^{(2)} \subseteq \{K_1, K_2, \dots, K_r\}$, and so on. This implies that $A_1^{(m-2)} \subseteq \{K_1, K_2, \dots, K_r\}$. Note that $R_{m-1} \subseteq E(A_1^{(m-2)})$ and each edge of R_{m-1} appears only in one cycle of A_1 . Thus $R_{m-1} \subseteq E(c_3)$. This is a contradiction. Hence $A_1 \cup \{c_3\}$ is linearly independent. Let $B_1 = A_1 \cup A_2 \cup A_3 \cup \{c_1, c_2, c_3\}$. To show that B_1 is a linearly independent set, we assume that there are two set of cycles say $\{d_1, d_2, \dots, d_{\gamma_1}\} \subseteq A_1 \cup \{c_3\}$ and $\{f_1, f_2, \dots, f_{\gamma_2}\} \subseteq A_2 \cup A_3 \cup \{c_1, c_2\}$ such that $\sum_{i=1}^{\gamma_1} d_i = \sum_{i=1}^{\gamma_2} f_i \pmod{2}$. By using the same argument as in Case 1, we have that $d_1 \oplus d_2 \oplus \dots \oplus d_{\gamma_1}$ contains at least one edge of the form $(1, j) (\delta, j+1)$ and $(1, j+1) (\delta, j)$ for some $j \leq m-1$. Which contradicts the fact that no cycle of $A_1 \cup \{c_1\}$ contains such edges. Now, let A_4, A_5, c'_3 and c'_4 are as defined in Case 1, and define the following cycles:

$$\begin{aligned}
c'_1 &= (1, 1) (2, m) (3, 1) \dots (\delta-1, 1) (\delta, m) (1, 1), \\
c'_2 &= (1, m) (2, 1) (3, m) \dots (\delta, 1) (1, m).
\end{aligned}$$

Let $D = A_4 \cup A_5 \cup \{c'_1, c'_2, c'_3, c'_4\}$. By following the same arguments as in Case 1, we can prove that $\mathcal{B} = B_1 \cup D$ is a 4-fold basis for $C(\theta_n \times C_m)$. The proof of this case is complete.

Case 3. m, n , and δ are even. Consider the following sets of cycles: A_1, A_2, A_3, A_4, A_5 and $\{c_1, c_2\}$ are as in Case 1. Also, consider $c_3 = c_1$ and $c_4 = c_2$ where c_1 and c_2 are as defined in Case 2. Moreover, c'_1 and c'_2 are as in Case 2. Define the following two cycles:

$$\begin{aligned}
c'_3 &= (1, 1) (2, m) (3, 1) \dots (n-1, 1) (n, m) (1, 1), \\
c'_4 &= (1, m) (2, 1) (3, m) \dots (n-1, m) (n, 1) (1, m).
\end{aligned}$$

By using the same arguments as in Case 1 and Case 2, we can show that

$$\mathcal{B} = A_1 \cup A_2 \cup A_3 \cup A_4 \cup A_5 \cup \{c_1, c_2, c_3, c_4, c'_1, c'_2, c'_3, c'_4\},$$

is linearly independent. Since

$$\begin{aligned}
|\mathcal{B}| &= \sum_{i=1}^5 |A_i| + 8 \\
&= n(m-2) + (m-2) + (m-2) + (n-1) + (n-1) + 8 \\
&= nm + 2m + 2 \\
&= \dim \mathcal{C}(\theta_n \times C_m),
\end{aligned}$$

\mathcal{B} is a basis of $\mathcal{C}(\theta_n \times C_m)$. To show that \mathcal{B} is a 4-fold basis, we follow, word by word, (1) to (11) of Case 1. The proof of this case is complete.

Case 4. m is even, and δ and n are odd. By relabeling the vertices of θ_n in the opposite direction, we get a similar case to Case 2. The proof of this case is complete.

Case 5. m is odd, and n and δ are even. Consider the following sets of cycles: A_1, A_2, A_3 and $\{c_1, c_2\}$ are as in Case 1. In addition, $c_3 = c_1$ and $c_4 = c_2$ where c_1 and c_2 are as in Case 2. Using the same arguments as in Case 1 and Case 2, we can show that each of $A_1 \cup \{c_1, c_2\}$ and $A_2 \cup A_3 \cup \{c_3, c_4\}$ are linearly independent. Also, then we show that $A_1 \cup A_2 \cup A_3 \cup \{c_1, c_2, c_3, c_4\}$ is linearly independent. Now, we define the following set of cycles:

$$A_4 = \left\{ a_4^{(i)} = (i, m)(i+1, m-1)(i+2, m)(i+1, 1)(i, m) : 1 \leq i \leq n-2 \right\},$$

and

$$A_5 = \left\{ a_5^{(i)} = (i, 1)(i+1, m)(i+2, 1)(i+1, 2)(i, 1) : 1 \leq i \leq n-2 \right\}.$$

Also, define the following cycle:

$$\begin{aligned}
c'_5 &= (n-1, 1)(n, m)(n-1, m-1)(n, m-2) \dots (n, 1)(n-1, m)(n, m-1) \\
&\quad (n-1, m-2) \dots (n, 2)(n-1, 1).
\end{aligned}$$

Note that, c'_5 contains the edge $(n-1, m)(n, 1)$ which does not occur in any cycle of $B_1 = A_1 \cup A_2 \cup A_3 \cup \{c_1, c_2, c_3, c_4\}$. Thus, $B_1 \cup \{c'_5\}$ is linearly independent. For simplicity, we set $D = \{D_k\}_{k=1}^{n-2}$, where $D_k = \{a_4^{(k)}, a_5^{(k)}\}$. We now, use induction on n to show that the cycles of D are linearly independent. If $n = 3$, then $D = D_1 = \{a_4^{(1)}, a_5^{(1)}\}$. $a_4^{(1)}$ contains the edge $(2, 1)(3, m)$ which does not occur in the cycle $a_5^{(1)}$. Hence D is linearly independent. Assume $n > 3$ and it is true for less than n . Note that $D = \{D_k\}_{k=1}^{n-3} \cup \{a_4^{(n-2)}, a_5^{(n-2)}\}$. By the inductive step $\{D_k\}_{k=1}^{n-3}$ is linearly independent. Now, the cycle $a_4^{(n-2)}$ contains the edge $(n-1, 1)(n, m)$ which does not occur in any cycle of $\{D_k\}_{k=1}^{n-3}$, similarly the cycle $a_5^{(n-2)}$ contains the edge $(n, 1)(n-1, m)$ which does not occur in any cycle of $\{D_k\}_{k=1}^{n-3} \cup \{a_4^{(n-2)}\}$. Therefore, D is linearly independent. Note that $E(D) - \{(i+1, 1)(i, m), (i, 1)(i+1, m) | 1 \leq i \leq n-2\}$ forms an edge set of a forest. Thus, any linear combination of cycles of D must contain an edge of the form $(i+1, 1)(i, m)$ or $(i, 1)(i+1, m)$ for some $1 \leq i \leq n-2$ which does not occur in any cycle of $B_1 \cup \{c'_5\}$. Therefore, $B_1 \cup \{c'_5\} \cup D$ is linearly independent.

We now consider c'_1 and c'_2 as in Case 2 and c'_3 and c'_4 as in Case 1. Note that c'_1 and c'_2 contain the edges $(1, 1)(\delta, m)$ and $(1, m)(\delta, 1)$, respectively, which do not appear in any cycle of $B_1 \cup \{c'_5\} \cup D$. Thus $B_1 \cup D \cup \{c'_1, c'_2, c'_5\}$ is linearly independent. Similarly c'_3 and c'_4 contain the edges $(1, 1)(n, m)$ and $(1, m)(n, 1)$, respectively, which do not appear in any cycle of $B_1 \cup \{c'_1, c'_2, c'_5\} \cup D$. Thus

$$\mathcal{B} = B_1 \cup D \cup \{c'_1, c'_2, c'_3, c'_4, c'_5\}$$

is linearly independent. Now,

$$\begin{aligned} |\mathcal{B}| &= \sum_{i=1}^5 |A_i| + 9 \\ &= n(m-2) + (m-2) + (m-2) + (n-2) + (n-2) + 9 \\ &= nm + 2m + 1 \\ &= \dim \mathcal{C}(\theta_n \times C_m). \end{aligned}$$

Hence, \mathcal{B} is a basis of $\mathcal{C}(\theta_n \times C_m)$. To complete the proof of this case, we show that \mathcal{B} is a 4-fold basis. Let $e \in E(\theta_n \times C_m)$. Then,

(1) If $e = (i+1, 1)(i, m)$ or $(i, 1)(i+1, m)$ where $1 \leq i \leq n-1$, then $f_{A_1}(e) = 0$, $f_{A_2 \cup A_3}(e) = 0$, $f_{D \cup \{c'_i\}_{i=1}^5}(e) \leq 3$, and $f_{\cup_{i=1}^4 \{c_i\}}(e) = 0$, and so $f_{\mathcal{B}}(e) \leq 3$.

(2) If e is as in (1) to (11) of Case 1 and not of the above form, then, as in that Case 1, $f_{\mathcal{B}}(e) \leq 4$. Therefore \mathcal{B} is a 4-fold basis. The proof of this case is complete.

Case 6. m and δ are odd and n is even. According to the relation between m and δ , we split this case into two subcases.

Subcase 6a. $\delta \leq m$. Then consider the following sets of cycles: $A_1, A_2, A_3, c_1, c_2, c_3$ are as in Case 1. In addition, for each $i = 2, 3, \dots, \delta$, we define the following sets of cycles.

$$\begin{aligned} F_i &= (i, 1)(i-1, 2)(i-2, 3) \dots (1, i)(\delta, i+1)(\delta-1, i+2) \\ &\quad (\delta-2, i+3) \dots (i, \delta+1)(i+1, \delta+2)(i, \delta+3) \dots (i-1, m)(i, 1), \end{aligned}$$

and for each $i = 1, 2, 3, \dots, \delta-1$

$$\begin{aligned} F'_i &= (i, 1)(i+1, 2)(i+2, 3) \dots (\delta, \delta-i+1)(1, \delta-i+2) \\ &\quad (2, \delta-i+3) \dots (i, \delta+1)(i+1, \delta+2)(i, \delta+3) \dots (i+1, m)(i, 1). \end{aligned}$$

Also, set

$$\begin{aligned} F_1 &= (1, 1)(\delta, 2)(\delta-1, 3)(\delta-2, 4) \dots (1, \delta+1)(\delta, \delta+2) \\ &\quad (1, \delta+3) \dots (1, m-1)(\delta, m)(1, 1), \end{aligned}$$

and

$$F'_\delta = (\delta, 1) (1, 2) (2, 3) (3, 4) \dots (\delta, \delta + 1) (1, \delta + 2) (\delta, \delta + 3) \\ (1, \delta + 4) \dots (\delta, m - 1) (1, m) (\delta, 1).$$

Let

$$F = \cup_{i=1}^{\delta} F_i \text{ and } F' = \cup_{i=1}^{\delta} F'_i.$$

By Case 1, $A_1 \cup A_2 \cup A_3 \cup \{c_1, c_2, c_3\}$ is linearly independent. Note that each cycle of F contains an edge of the form $(i - 1, m) (i, 1)$ or $(\delta, m) (1, 1)$ for some $2 \leq i \leq \delta$ which does not occur in any other cycle of $A_1 \cup A_2 \cup A_3 \cup F \cup \{c_1, c_2, c_3\}$. Thus, $A_1 \cup A_2 \cup A_3 \cup F \cup \{c_1, c_2, c_3\}$ is linearly independent. Similarly, each cycle of F' contains an edge of the form $(i + 1, m) (i, 1)$ or $(1, m) (\delta, 1)$ for some $1 \leq i \leq \delta - 1$ which does not occur in any other cycle of $A_1 \cup A_2 \cup A_3 \cup F \cup F' \cup \{c_1, c_2, c_3\}$. Thus, $A_1 \cup A_2 \cup A_3 \cup F \cup F' \cup \{c_1, c_2, c_3\}$ is linearly independent. Now, define the following sets of cycles:

$$A_4 = \left\{ a_4^{(i)} = (i, m) (i + 1, m - 1) (i + 2, m) (i + 1, 1) (i, m) : \delta - 1 \leq i \leq n - 2 \right\},$$

and

$$A_5 = \left\{ a_5^{(i)} = (i, 1) (i + 1, m) (i + 2, 1) (i + 1, 2) (i, 1) : \delta - 1 \leq i \leq n - 2 \right\}.$$

Also, set the following cycles:

$$c_4 = (1, 1) (2, m) (3, 1) \dots (n, m) (1, 1), \\ c_5 = (1, m) (2, 1) (3, m) \dots (n, 1) (1, m).$$

By using the same arguments as in Case 5, we can show that $A_4 \cup A_5$ is linearly independent. Since each linear combination of cycles of $A_4 \cup A_5$ contains an edge of the form $(i + 1, 1) (i, m)$ or $(i, 1) (i + 1, m)$ for some $\delta \leq i \leq n - 2$ which does not occurs in any cycle of $A_1 \cup A_2 \cup A_3 \cup F \cup F' \cup \{c_1, c_2, c_3\}$, $A_1 \cup A_2 \cup A_3 \cup A_4 \cup A_5 \cup F \cup F' \cup \{c_1, c_2, c_3\}$ is linearly independent. Finally, c_4 contains the edge $(n, m) (1, 1)$ and c_5 contains the edge $(n, 1) (1, m)$ which do not appear in any cycle of $A_1 \cup A_2 \cup A_3 \cup A_4 \cup A_5 \cup F \cup F' \cup \{c_1, c_2, c_3\}$. Thus,

$$\mathcal{B} = A_1 \cup A_2 \cup A_3 \cup A_4 \cup A_5 \cup F \cup F' \cup \{c_1, c_2, c_3, c_4, c_5\}$$

is linearly independent. Since

$$\begin{aligned} |\mathcal{B}| &= \sum_{i=1}^5 |A_i| + |F| + |F'| + \sum_{i=1}^5 |c_i| \\ &= n(m - 2) + (m - 2) + (m - 2) + (n - \delta) + \\ &\quad (n - \delta) + \delta + \delta + 5 \\ &= mn + 2m + 1 \\ &= \dim \mathcal{C}(\theta_n \times C_m), \end{aligned}$$

\mathcal{B} is a basis of $\mathcal{C}(\theta_n \times C_m)$. To complete the proof of the theorem we only need to prove that \mathcal{B} is a 4-fold basis. For simplicity let $Q = \cup_{i=1}^5 \{c_i\}$. Let $e \in E(\theta_n \times C_m)$. Then

(1) if $e = (i, j)(i+1, j+1)$ or $(n, j)(1, j+1)$, where $1 \leq i \leq n-1$, and $2 \leq j \leq m-2$, then $f_{A_1}(e) = 2$, $f_{A_2 \cup A_3}(e) \leq 1$, $f_{F \cup F'}(e) = 1$, and $f_Q(e) = 0$, and so $f_{\mathcal{B}}(e) \leq 4$.

(2) If $e = (i, j)(i+1, j-1)$ or $(n, j)(1, j-1)$, where $1 \leq i \leq n-1$, and $3 \leq j \leq m-1$, then $f_{A_1}(e) = 2$, $f_{A_2 \cup A_3}(e) \leq 1$, $f_{F \cup F'}(e) = 1$, and $f_Q(e) = 0$, and so $f_{\mathcal{B}}(e) \leq 4$.

(3) If $e = (i, 1)(i+1, 2)$ or $(1, 1)(n, 2)$, where $1 \leq i \leq n-1$, then $f_{A_1}(e) = 1$, $f_{A_2 \cup A_3}(e) \leq 1$, $f_{F \cup F'}(e) = 1$, and $f_Q(e) = 1$, and so $f_{\mathcal{B}}(e) \leq 4$.

(4) If $e = (i, 2)(i+1, 1)$ or $(1, 2)(n, 1)$, where $1 \leq i \leq n-1$, then $f_{A_1}(e) = 1$, $f_{A_2 \cup A_3}(e) \leq 1$, $f_{F \cup F'}(e) = 0$, and $f_Q(e) = 1$, and so $f_{\mathcal{B}}(e) \leq 3$.

(5) If $e = (1, j)(\delta, j+1)$, where $1 \leq j \leq m-2$, then $f_{A_1}(e) = 0$, $f_{A_2 \cup A_3}(e) \leq 2$, $f_{F \cup F'}(e) = 1$, and $f_Q(e) = 0$, and so $f_{\mathcal{B}}(e) \leq 3$.

(6) If $e = (1, j)(\delta, j-1)$, where $2 \leq j \leq m-2$, then $f_{A_1}(e) = 0$, $f_{A_2 \cup A_3}(e) \leq 2$, $f_{F \cup F'}(e) = 1$, and $f_Q(e) = 0$, and so $f_{\mathcal{B}}(e) \leq 3$.

(7) If $e = (i, m-1)(i+1, m)$ or $(i, m)(i+1, m-1)$ or $(1, m)(n, m-1)$, where $1 \leq i \leq n-1$, then $f_{A_1}(e) = 1$, $f_{A_2 \cup A_3}(e) \leq 1$, $f_{F \cup F'}(e) = 1$, and $f_Q(e) \leq 1$, and so $f_{\mathcal{B}}(e) \leq 4$.

(8) If $e = (1, m)(\delta, m-1)$ or $(1, m-1)(\delta, m)$, then $f_{A_1}(e) = 0$, $f_{A_2 \cup A_3}(e) \leq 1$, $f_{F \cup F'}(e) = 1$, and $f_Q(e) \leq 1$, and so $f_{\mathcal{B}}(e) \leq 3$.

(9) If $e = (i, 1)(i+1, m)$ or $(i+1, 1)(i, m)$, where $1 \leq i \leq n-2$, then $f_{A_1}(e) = 0$, $f_{A_2 \cup A_3}(e) = 0$, $f_{F \cup F'}(e) \leq 2$, and $f_Q(e) \leq 1$, and so $f_{\mathcal{B}}(e) \leq 3$.

(10) If $e = (1, 1)(\delta, m)$ or $(1, m)(\delta, 1)$, then $f_{A_1}(e) = 0$, $f_{A_2 \cup A_3}(e) = 0$, $f_{F \cup F'}(e) = 1$, and $f_Q(e) = 0$, and so $f_{\mathcal{B}}(e) \leq 1$.

(11) If $e = (1, 1)(n, m)$ or $(n, 1)(1, m)$, then $f_{A_1}(e) = 0$, $f_{A_2 \cup A_3}(e) = 0$, $f_{F \cup F'}(e) \leq 1$, and $f_Q(e) \leq 1$, and so $f_{\mathcal{B}}(e) \leq 2$. Therefore \mathcal{B} is a 4-fold basis.

Subcase 6b. $m < \delta$. Then consider the following set of cycles: A_1, c_1, c_2 are as in Case 1 and A_4 and A_5 are as in Case 4, and

$$c_3 = (1, 1)(2, 2)(1, 3)(2, 4) \dots (1, m)(2, 1)(1, 2)(2, 3) \dots (2, m)(1, 1).$$

Using similar arguments to Case 5, we can show that $A_1 \cup A_4 \cup A_5 \cup \{c_1, c_2, c_3\}$ is a linearly independent set. Now, let c_4 and c_5 be the two cycles as in the Subcase 6a. Then c_4 contains the edge $(n, m)(1, 1)$ which does not appear in the cycles of $A_1 \cup A_4 \cup A_5 \cup \{c_1, c_2, c_3\}$. Thus, $A_1 \cup A_4 \cup A_5 \cup \{c_1, c_2, c_3, c_4\}$ is linearly independent. Similarly, c_5 contains the edge $(n, 1)(1, m)$ which does not appear in any cycle of $A_1 \cup A_4 \cup A_5 \cup \{c_1, c_2, c_3, c_4\}$. Therefore, $A_1 \cup A_4 \cup A_5 \cup \{c_1, c_2, c_3, c_4, c_5\}$ is linearly independent. Now, for $j = 2, 3, \dots, m$ define the following cycles:

$$\begin{aligned} F_i &= (1, j)(2, j-1)(3, j-2) \dots (j, 1)(j+1, m)(j+2, m-1)(j+3, m-2) \dots \\ &\quad (m+1, j)(m+2, j-1)(m+3, j) \dots (\delta, j-1)(1, j), \end{aligned}$$

and for $j = 1, 2, 3, \dots, m-1$

$$\begin{aligned} F'_i &= (1, j)(2, j+1)(3, j+2) \dots (m-j+1, m)(m-j+2, 1)(m-j+3, 2) \\ &\quad (m-j+4, 3) \dots (m+1, j)(m+2, j+1)(m+3, j) \dots (\delta, j+1)(1, j). \end{aligned}$$

Moreover, define

$$\begin{aligned} F_1 &= (1, 1)(2, m)(3, m-1)(4, m-2) \dots (m+1, 1)(m+2, m)(m+3, 1) \dots (\delta, m)(1, 1) \\ F'_m &= (1, m)(2, 1)(3, 2)(4, 3) \dots (m+1, m)(m+2, 1)(m+3, 2) \dots (\delta, 1)(1, m). \end{aligned}$$

Let

$$F = \cup_{i=1}^m F_i \text{ and } F' = \cup_{i=1}^m F'_i.$$

Note that each cycle of $F \cup F'$ contains an edge of the form $(\delta, j+1)(1, j)$ or $(\delta, j-1)(1, j)$ which does not appear in other cycles of

$$\mathcal{B} = A_1 \cup A_4 \cup A_5 \cup F \cup F' \cup \{c_1, c_2, c_3, c_4, c_5\}$$

Thus, \mathcal{B} is linearly independent. Since

$$\begin{aligned} |B| &= |A_1| + |A_4| + |A_5| + |F| + |F'| + \sum_{i=1}^5 |c_i| \\ &= (m-2)n + (n-2) + (n-2) + m + m + 5 \\ &= mn + 2m + 1 \\ &= \dim \mathcal{C}(\theta_n \times C_m), \end{aligned}$$

\mathcal{B} is a basis for $\mathcal{C}(\theta_n \times C_m)$. Now to complete the proof, we show that \mathcal{B} is a 4-fold basis. Let $e \in E(\theta_n \times C_m)$. Then

(1) if $e = (i, j)(i+1, j+1)$ where $1 \leq i \leq \delta-2$, and $1 \leq j \leq m-1$ or $(i, j)(i-1, j-1)$, where $2 \leq i \leq \delta-1$, and $2 \leq j \leq m$, then $f_{A_1 \cup \{c_i\}_{i=1}^5}(e) \leq 2$, $f_{A_4 \cup A_5}(e) \leq 1$, $f_{F \cup F'}(e) \leq 1$, and so $f_{\mathcal{B}}(e) \leq 4$.

(2) If $e = (i, j)(i+1, j+1)$ where $\delta \leq i \leq n-1$, and $1 \leq j \leq m-1$ or $(i, j)(i-1, j-1)$, where $\delta+1 \leq i \leq n$, and $2 \leq j \leq m$, then $f_{A_1 \cup \{c_i\}_{i=1}^5}(e) \leq 3$, $f_{A_4 \cup A_5}(e) \leq 1$, $f_{F \cup F'}(e) = 0$ and so $f_{\mathcal{B}}(e) \leq 4$.

(3) If $e = (i, 1)(i+1, m)$ or $(i+1, 1)(i, m)$ or $(1, 1)(n, m)$ or $(1, m)(n, 1)$ where $1 \leq i \leq n-2$, then $f_{A_1 \cup \{c_i\}_{i=1}^5}(e) \leq 1$, $f_{A_4 \cup A_5}(e) \leq 2$, $f_{F \cup F'}(e) = 0$ and so $f_{\mathcal{B}}(e) \leq 3$.

(4) If $e = (1, j)(\delta, j+1)$ or $(1, j+1)(\delta, j)$ or $(1, 1)(\delta, m)$ or $(1, m)(\delta, 1)$ where $1 \leq j \leq m-1$, then $f_{A_1 \cup \{c_i\}_{i=1}^5}(e) \leq 1$, $f_{A_4 \cup A_5}(e) \leq 1$, $f_{F \cup F'}(e) \leq 1$, and so $f_{\mathcal{B}}(e) \leq 3$.

(5) If $e = (1, 1)(n, m)$ or $(1, m)(n, 1)$, then $f_{A_1 \cup \{c_i\}_{i=1}^5}(e) \leq 1$, $f_{A_4 \cup A_5}(e) = 0$, $f_{F \cup F'}(e) = 0$, so $f_{\mathcal{B}}(e) \leq 1$.

Thus, \mathcal{B} is a 4-fold basis. The proof of this case is complete.

Case 7. m and n are odd, and δ is even. According to the relation between m and n , we split this case into two subcases.

Subcase 7a. $m \geq n$. Then consider the following sets of cycles: A_1, A_2 and A_3 are as in Case 1 and c_1, c_2, c_3, c'_1 and c'_2 are as in Case 2. Also, for $i = 2, 3, \dots, n$, define the following cycles:

$$F_i = (i, 1)(i-1, 2)(i-2, 3) \dots (1, i)(n, i+1)(n-1, i+2)(n-2, i+3) \dots (i, n+1) \\ (i-1, n+2)(i, n+3) \dots (i-1, m)(i, 1),$$

and for $i = 1, 2, 3, \dots, n-1$

$$F'_i = (i, 1)(i+1, 2)(i+2, 3) \dots (n, n-i+1)(1, m-i+2) \\ (2, m-i+3) \dots (i, n+1)(i+1, n+2)(i, n+3) \dots (i+1, m)(i, 1).$$

Moreover, set

$$F_1 = (1, 1)(n, 2)(n-1, 3)(n-2, 4) \dots (1, n+1)(n, n+2)(1, n+3) \dots \\ (1, m-1)(n, m)(1, 1),$$

and

$$F'_n = (n, 1)(1, 2)(2, 3)(3, 4) \dots (n, n+1)(1, n+2)(n, n+3) \\ (1, n+4) \dots (n, m-1)(1, m)(n, 1).$$

Let

$$F = \cup_{i=1}^n F_i \text{ and } F' = \cup_{i=1}^n F'_i.$$

By Case 2, $A_1 \cup A_2 \cup A_3 \cup c_1 \cup c_2 \cup c_3 \cup c'_1 \cup c'_2$ is linearly independent. By a similar argument as in Subcase 6a, we can show that

$$\mathcal{B} = A_1 \cup A_2 \cup A_3 \cup F \cup F' \cup c_1 \cup c_2 \cup c_3 \cup c'_1 \cup c'_2$$

is a linearly independent set of cycles. Since

$$|\mathcal{B}| = \sum_{i=1}^3 |A_i| + |F| + |F'| + \sum_{i=1}^3 |c_i| + |c'_1| + |c'_2| \\ = (m-2)n + (m-2) + (m-2) + n + n + 5 \\ = mn + 2m + 1 \\ = \dim \mathcal{C}(\theta_n \times C_m),$$

\mathcal{B} is a cycle basis of $\theta_n \times C_m$. For simplicity, set $Q = \cup_{i=1}^3 \{c_i\}_{i=1}^3$. Let $e \in E(\theta_n \times C_m)$. Then

(1) if $e = (i, j)(i+1, j+1)$ or $(n, j)(1, j+1)$, where $1 \leq i \leq n-1$, and $2 \leq j \leq m-2$, then $f_{A_1}(e) = 2$, $f_{A_2 \cup A_3}(e) \leq 1$, $f_{F \cup F'}(e) = 1$, $f_{c'_1 \cup c'_2}(e) = 0$ and $f_Q(e) = 0$, and so $f_{\mathcal{B}}(e) \leq 4$.

(2) If $e = (i, j)(i + 1, j - 1)$ or $(n, j)(1, j - 1)$, where $1 \leq i \leq n - 1$, and $3 \leq j \leq m - 1$, then $f_{A_1}(e) = 2$, $f_{A_2 \cup A_3}(e) \leq 1$, $f_{F \cup F'}(e) = 1$, $f_{c'_1 \cup c'_2}(e) = 0$ and $f_Q(e) = 0$, and so $f_{\mathcal{B}}(e) \leq 4$.

(3) If $e = (i, 1)(i + 1, 2)$ or $(1, 1)(n, 2)$, where $1 \leq i \leq n - 1$, then $f_{A_1}(e) = 1$, $f_{A_2 \cup A_3}(e) \leq 1$, $f_{F \cup F'}(e) = 1$, $f_{c'_1 \cup c'_2}(e) = 0$ and $f_Q(e) = 1$, and so $f_{\mathcal{B}}(e) \leq 4$.

(4) If $e = (i, 2)(i + 1, 1)$ or $(1, 2)(n, 1)$, where $1 \leq i \leq n - 1$, then $f_{A_1}(e) = 1$, $f_{A_2 \cup A_3}(e) \leq 1$, $f_{F \cup F'}(e) = 0$, $f_{c'_1 \cup c'_2}(e) = 0$ and $f_Q(e) = 1$, and so $f_{\mathcal{B}}(e) \leq 3$.

(5) If $e = (1, j)(\delta, j + 1)$, where $1 \leq j \leq m - 2$, then $f_{A_1}(e) = 0$, $f_{A_2 \cup A_3}(e) \leq 2$, $f_{F \cup F'}(e) = 1$, $f_{c'_1 \cup c'_2}(e) = 0$ and $f_Q(e) = 0$, and so $f_{\mathcal{B}}(e) \leq 3$.

(6) If $e = (1, j)(\delta, j - 1)$, where $2 \leq j \leq m - 2$, then $f_{A_1}(e) = 0$, $f_{A_2 \cup A_3}(e) \leq 2$, $f_{F \cup F'}(e) = 0$, $f_{c'_1 \cup c'_2}(e) = 0$ and $f_Q(e) = 0$, and so $f_{\mathcal{B}}(e) \leq 2$.

(7) If $e = (i, m - 1)(i + 1, m)$ or $(i, m)(i + 1, m - 1)$ or $(1, m)(n, m - 1)$, where $1 \leq i \leq n - 1$, then $f_{A_1}(e) = 1$, $f_{A_2 \cup A_3}(e) \leq 1$, $f_{F \cup F'}(e) = 1$, $f_{c'_1 \cup c'_2}(e) = 0$ and $f_Q(e) \leq 1$, and so $f_{\mathcal{B}}(e) \leq 4$.

(8) If $e = (1, m)(\delta, m - 1)$ or $(1, m - 1)(\delta, m)$, then $f_{A_1}(e) = 0$, $f_{A_2 \cup A_3}(e) \leq 1$, $f_{F \cup F'}(e) = 0$, $f_{c'_1 \cup c'_2}(e) = 0$ and $f_Q(e) \leq 1$, and so $f_{\mathcal{B}}(e) \leq 2$.

(9) If $e = (i, 1)(i + 1, m)$ or $(i + 1, 1)(i, m)$, where $1 \leq i \leq n - 2$, then $f_{A_1}(e) = 0$, $f_{A_2 \cup A_3}(e) = 0$, $f_{F \cup F'}(e) = 1$, $f_{c'_1 \cup c'_2}(e) \leq 1$ and $f_Q(e) = 0$, and so $f_{\mathcal{B}}(e) \leq 2$.

(10) If $e = (1, 1)(\delta, m)$ or $(m, 1)(\delta, 1)$, then $f_{A_1}(e) = 0$, $f_{A_2 \cup A_3}(e) = 0$, $f_{F \cup F'}(e) = 0$, $f_{c'_1 \cup c'_2}(e) = 1$ and $f_Q(e) = 0$, and so $f_{\mathcal{B}}(e) \leq 1$.

(11) If $e = (1, 1)(n, m)$ or $(n, 1)(1, m)$, then $f_{A_1}(e) = 0$, $f_{A_2 \cup A_3}(e) = 0$, $f_{F \cup F'}(e) = 1$, $f_{c'_1 \cup c'_2}(e) \leq 1$ and $f_Q(e) = 0$, and so $f_{\mathcal{B}}(e) \leq 2$. Therefore \mathcal{B} is a 4-fold basis.

Subcase 7b. $m < n$. Then consider c'_1 and c'_2 as in Case 2 and c'_5 , A_4 and A_5 as in Case 5. Moreover, set

$$\begin{aligned} A'_1 &= A_1 - \{(1, j)(2, j + 1)(1, j + 2)(n, j + 1)(1, j) : j = 1, 2, \dots, m - 2\} \\ &\quad \cup \{(n, j)(n - 1, j + 1)(n, j + 2)(1, j + 1)(n, j) : j = 1, 2, \dots, m - 2\}, \end{aligned}$$

where A_1 is as in Case 1. Also, set

$$\begin{aligned} A'_2 &= \{(1, j)(2, j + 1)(3, j)(4, j + 1) \dots (\delta, j + 1)(1, j) | j = 1, 2, \dots, m - 1\} \\ A'_3 &= \{(1, j - 1)(2, j)(3, j - 1) \dots (\delta, j)(1, j - 1) | j = 2, \dots, m\}. \end{aligned}$$

By Case 5 and noting that each cycle of $A'_2 \cup A'_3$ contains an edge of the form $(\delta, j + 1)(1, j)$ for some $1 \leq j \leq m - 1$ or an edge of the form $(\delta, j)(1, j - 1)$ for some $2 \leq j \leq m$ which appears in no cycle of $A'_1 \cup A_4 \cup A_5 \cup c'_1 \cup c'_2 \cup c'_5$, we have that $A'_1 \cup A'_2 \cup A'_3 \cup A_4 \cup A_5 \cup c'_1 \cup c'_2 \cup c'_5$ is linearly independent. Now, for $j = 2, 3, \dots, m$, consider the following cycles:

$$\begin{aligned} F_i &= (1, j)(2, j - 1)(3, j - 2) \dots (j, 1)(j + 1, m)(j + 2, m - 1)(j + 3, m - 2) \dots \\ &\quad (m + 1, j)(m + 2, j - 1)(m + 3, j) \dots (n, j - 1)(1, j), \end{aligned}$$

and for $j = 1, 2, 3, \dots, m-1$

$$F'_i = (1, j)(2, j+1)(3, j+2) \dots (m-j+1, m)(m-j+2, 1)(m-j+3, 2)(m-j+4, 3) \dots \\ (m+1, j)(m+2, j+1)(m+3, j) \dots (n, j+1)(1, j).$$

Moreover, set

$$F_1 = (1, 1)(2, m)(3, m-1)(4, m-2) \dots (m+1, 1)(m+2, m)(m+3, 1) \dots (n, m)(1, 1) \\ F'_m = (1, m)(2, 1)(3, 2)(4, 3) \dots (m+1, m)(m+2, 1)(m+3, 2) \dots (n, 1)(m, 1),$$

Let

$$F = \cup_{i=1}^m F_i \text{ and } F' = \cup_{i=1}^m F'_i.$$

Using a similar arguments as in Subcase 6b, we show that

$$\mathcal{B} = A'_1 \cup A'_2 \cup A'_3 \cup A_4 \cup A_5 \cup F \cup F' \cup c'_1 \cup c'_2 \cup c'_5$$

is linearly independent. Note that

$$|B| = \sum_{i=1}^3 |A'_i| + |A_4| + |A_5| + |F| + |F'| + 3 \\ = (m-2)(n-2) + (m-1) + (m-1) + (n-2) + (n-2) + m + m + 3 \\ = mn + 2m + 1 \\ = \dim \mathcal{C}(\theta_n \times C_m).$$

Thus, \mathcal{B} is a basis for $\mathcal{C}(\theta_n \times C_m)$. Now, let $e \in E(\theta_n \times C_m)$. Then

(1) If $e = (i, j)(i+1, j+1)$, where $1 \leq i \leq n-2$, and $1 \leq j \leq m-1$, then $f_{A'_1 \cup A'_2 \cup A'_3 \cup A_4 \cup A_5}(e) \leq 3$, $f_{F \cup F'}(e) = 1$, $f_{\{c'_5\}}(e) = 0$ and $f_{\{c'_1, c'_2\}}(e) = 0$, and so $f_{\mathcal{B}}(e) \leq 4$.

(2) If $e = (i, j)(i-1, j+1)$, where $2 \leq i \leq n-1$, and $1 \leq j \leq m-1$, then $f_{A'_1 \cup A'_2 \cup A'_3 \cup A_4 \cup A_5}(e) \leq 3$, $f_{F \cup F'}(e) \leq 1$, $f_{\{c'_5\}}(e) = 0$ and $f_{\{c'_1, c'_2\}}(e) = 0$, and so $f_{\mathcal{B}}(e) \leq 4$.

(3) If $e = (n-1, j)(n, j+1)$ or $(n-1, j+1)(n, j)$ or $(n-1, 1)(n, m)$ or $(n-1, m)(n, 1)$, where $1 \leq j \leq m-2$, then $f_{A'_1 \cup A'_2 \cup A'_3 \cup A_4 \cup A_5}(e) \leq 3$, $f_{F \cup F'}(e) = 0$, $f_{\{c'_5\}}(e) \leq 1$ and $f_{\{c'_1, c'_2\}}(e) = 0$, and so $f_{\mathcal{B}}(e) \leq 4$.

(4) If $e = (1, j)(\delta, j+1)$ or $(1, j+1)(\delta, j)$ or $(1, 1)(\delta, m)$ or $(1, m)(\delta, 1)$ where $1 \leq j \leq m$, then $f_{A'_1 \cup A'_2 \cup A'_3 \cup A_4 \cup A_5}(e) \leq 1$, $f_{F \cup F'}(e) \leq 1$, $f_{\{c'_5\}}(e) = 0$ and $f_{\{c'_1, c'_2\}}(e) \leq 1$, and so $f_{\mathcal{B}}(e) \leq 3$.

(5) If $e = (1, j)(n, j+1)$ or $(1, j+1)(n, j+1)$ or $(1, 1)(n, m)$ or $(1, m)(n, 1)$ where $1 \leq j \leq m-1$, then $f_{A'_1 \cup A'_2 \cup A'_3 \cup A_4 \cup A_5}(e) = 0$, $f_{F \cup F'}(e) \leq 1$, $f_{\{c'_5\}}(e) = 0$ and $f_{\{c'_1, c'_2\}}(e) = 0$, and so $f_{\mathcal{B}}(e) \leq 1$. Thus, \mathcal{B} is a 4-fold basis of $\mathcal{C}(\theta_n \times C_m)$. The proof of this case is complete.

Case 8. m, n and δ are odd. By relabeling the vertices of θ_n in the opposite direction, we get a similar case to Case 6. The proof of this case is complete. \square

By combining Lemma 3.3 and Lemma 3.4, we have the following result.

Theorem 3.5. For any graph θ_n of order $n \geq 4$ and cycle C_m of order $m \geq 3$, we have $3 \leq b(\theta_n \times C_m) \leq 4$.

References

- [1] A.A. Ali, The basis number of complete multipartite graphs, *Ars Combin.* 28 (1989), 41-49.
- [2] A.A. Ali, The basis number of the direct product of paths and cycles, *Ars Combin.* 27 (1988), 155-163.
- [3] A.A. Ali and G.T. Marougi, The basis number of Cartesian product of some graphs, *The J. of the Indian Math. Soc.* 58 (1992), 123-134.
- [4] A.S. Alsardary and J. Wojciechowski, The basis number of the powers of the complete graph, *Discrete Math.* 188 (1998), 13-25.
- [5] M.M. Jaradat, On the basis number of the direct product of graphs, *Australas. J. Combin.* 27 (2003), 293-306.
- [6] M.M. Jaradat, The basis number of the direct product of a theta graph and a path, *Ars Combin.* 75 (2005), 105-111.
- [7] M.M. Jaradat, The Basis Number of the semi-strong product of bipartite graphs with cycles, *Kyungpook Math. J.* 45 (2005), 45-53.
- [8] M.M. Jaradat and M.Y. Alzoubi, Un upper bound of the basis number of the lexicographic products of graphs, *Australas. J. Combin.* 32 (2005), 305-312.
- [9] M.M. Jaradat, An upper bound of the basis number of the strong product of graphs, *Discussion Mathematica Graph Theory* 25 (2005), 391-406.
- [10] M.M. Jaradat, A new upper bound of the basis number of the lexicographic product of graphs, To appear in *Ars Combin.*
- [11] S. MacLane, A combinatorial condition for planar graphs, *Fundamenta Math.* 28 (1937), 22-32.
- [12] E.F. Schmeichel, The basis number of a graph, *J. Combin. Theory Ser. B*, 30 (1981), 123-129.

A Note on Differential Geometry of the Curves in E^4

Suha Yilmaz, Suur Nizamoglu and Melih Turgut

(Department of Mathematics of Dokuz Eylul University, 35160 Buca-Izmir, Turkey.)

E-mail: suha.yilmaz@yahoo.com, melih.turgut@gmail.com

Abstract: In this note, we prove that every regular curve in four dimensional Euclidean space satisfies a vector differential equation of fifth order. Thereafter, in the same space, a relation among curvatures functions of inclined curves is obtained in terms of harmonic curvatures, which is related with Smarandache geometries ([5]).

Key Words: Euclidean space, Frenet formulas, inclined curves, harmonic curvatures.

AMS(2000): 51M05, 53A04.

§1. Introduction

At the beginning of the twentieth century, A.Einstein's theory opened a door of use of new geometries. These geometries mostly have higher dimensions. In higher dimensional Euclidean space, researchers treated some topics of classical differential geometry [1], [2] and [3].

It is well-known that, if a curve differentiable in an open interval, at each point, a set of mutually orthogonal unit vectors can be constructed. And these vectors are called *Frenet frame* or *moving frame vectors*. The rates of these frame vectors along the curve define curvatures of the curves. The set, whose elements are frame vectors and curvatures of a curve, is called *Frenet apparatus of the curves*.

In [1], author wrote a relation of inclined curves. In this work, first, we prove that every regular curve in four dimensional Euclidean space satisfies a vector differential equation of fifth order. This result is obtained by means of Frenet formulas. Then using relation of inclined curves written in [1], we express a new relation for inclined curves in Euclidean space E^4 , which is related with Smarandache geometries, see [5] for details.

§2. Preliminaries

To meet the requirements in the next sections, here, the basic elements of the theory of curves in the space E^4 are briefly presented (a more complete elementary treatment can be found in [4]).

Let $\alpha : I \subset \mathbb{R} \rightarrow E^4$ be an arbitrary curve in the Euclidean space E^4 . Recall that the curve α is said to be of unit speed (or parameterized by arclength function s) if $\langle \alpha'(s), \alpha'(s) \rangle = 1$, where $\langle \cdot, \cdot \rangle$ is the standard scalar (inner) product of E^4 given by

¹Received February 12, 2008. Accepted April 25, 2008.

$$\langle X, Y \rangle = x_1y_1 + x_2y_2 + x_3y_3 + x_4y_4, \quad (1)$$

for each $X = (x_1, x_2, x_3, x_4)$, $Y = (y_1, y_2, y_3, y_4) \in E^4$. In particular, the norm of a vector $X \in E^4$ is given by

$$\|X\| = \sqrt{\langle X, X \rangle}.$$

Let $\{T(s), N(s), B(s), E(s)\}$ be the moving frame along the unit speed curve α . Then the Frenet formulas are given by [2]

$$\begin{bmatrix} T' \\ N' \\ B' \\ E' \end{bmatrix} = \begin{bmatrix} 0 & \kappa & 0 & 0 \\ -\kappa & 0 & \tau & 0 \\ 0 & -\tau & 0 & \sigma \\ 0 & 0 & -\sigma & 0 \end{bmatrix} \begin{bmatrix} T \\ N \\ B \\ E \end{bmatrix}. \quad (2)$$

Here T, N, B and E are called the *tangent*, the *normal*, the *binormal* and the *trinormal vector fields of the curves*, respectively, and the functions $\kappa(s), \tau(s)$ and $\sigma(s)$ are called the first, the second and the third curvature of a curve in E^4 , respectively. Also, the functions $H_1 = \frac{\kappa}{\tau}$ and $H_2 = \frac{H_1'}{\sigma}$ are called *harmonic curvatures* of the curves in E^4 , where $\kappa \neq 0, \tau \neq 0$ and $\sigma \neq 0$. Let $\alpha : I \subset R \rightarrow E^4$ be a regular curve. If tangent vector field T of α forms a constant angle with unit vector U , this curve is called an inclined curve in E^4 .

In the same space, the author wrote a characterization for inclined curves with the following theorem in [1].

Theorem 2.1 *Let $\alpha : I \subset R \rightarrow E^4$ be an unit speed regular curve with curvatures $\kappa \neq 0, \tau \neq 0$ and $\sigma \neq 0$. α is an inclined curve if and only if there is a relation*

$$\frac{\kappa}{\tau} = A \cos \int_0^s \sigma ds + B \sin \int_0^s \sigma ds, \quad (3)$$

where $A, B \in R$.

§3. Vector Differential Equation of Fifth Order Satisfied by Regular Curves in E^4

Theorem 3.1 *Let $X : I \subset R \rightarrow E^4$ be an unit speed regular curve with curvatures $\kappa \neq 0, \tau \neq 0$ and $\sigma \neq 0$ in E^4 . Position vector and curvatures of α satisfies a vector differential equation of fifth order.*

Proof Let $X : I \subset R \rightarrow E^4$ be an unit speed regular curve with curvatures $\kappa \neq 0, \tau \neq 0$ and $\sigma \neq 0$ in E^4 . Considering Frenet equations, we write that

$$N = \frac{T'}{\kappa} \quad (4)$$

and

$$B = \frac{1}{\tau}(\kappa T + N'). \quad (5)$$

Substituting (3) in (1)₃, we get

$$B' = -\frac{\tau}{\kappa}T' + \sigma E. \quad (6)$$

Then, differentiating (3) and substituting it to (4), we find

$$B = \frac{1}{\tau} \left[\kappa T + \left(\frac{T'}{\kappa} \right)' \right]. \quad (7)$$

Taking the integral on both sides of (1)₄, we know

$$E = - \int \sigma B ds \quad (8)$$

and substituting (6) to (7), we get

$$E = - \int \frac{\sigma}{\tau} \left[\kappa T + \left(\frac{T'}{\kappa} \right)' \right] ds. \quad (9)$$

Applying (8) in (5), we have

$$B' = -\frac{\tau}{\kappa}T' - \sigma \int \frac{\sigma}{\tau} \left[\kappa T + \left(\frac{T'}{\kappa} \right)' \right] ds. \quad (10)$$

Similarly, differentiating (6) and considering (9), then

$$\left\{ \begin{array}{l} \left(\frac{1}{\tau} \right)' \left[\frac{T''\kappa - T'\kappa'}{\kappa^2} + \kappa T \right] + \\ \frac{1}{\tau} \left[\frac{(T'''\kappa + T'\kappa'')\kappa^2 - 2\kappa\kappa'(T''\kappa - T'\kappa')}{\kappa^3} + \kappa'T + \kappa T' \right] \\ + \frac{\tau}{\kappa}T' + \sigma \int \frac{\sigma}{\tau} \left[\kappa T + \left(\frac{T'}{\kappa} \right)' \right] ds \end{array} \right\} = 0 \quad (11)$$

is obtained. One more differentiating of (10) and simplifying this with $\dot{X} = T$, $\ddot{X} = T'$, $\ddot{\dot{X}} = T''$, $X^{(IV)} = T'''$ and $X^{(V)} = T^{(IV)}$, we know

$$\left\{ \begin{array}{l} \left[\frac{1}{\kappa\tau} \right] X^{(V)} + \left[\frac{\kappa'}{\kappa^2\tau} + \left(\frac{1}{\tau} \right)' \frac{1}{\kappa} + \left(\frac{1}{\kappa^4\tau} \right)' \kappa + \frac{2}{\kappa^3\tau} \right] \cdot X^{(IV)} + \\ \left[\left(\frac{1}{\tau} \right)'' \frac{1}{\kappa} - 2 \left(\frac{1}{\tau} \right)' \frac{\kappa'}{\kappa^2} - \kappa^2 \kappa' \tau \left(\frac{1}{\kappa^4\tau} \right)' - \frac{\kappa''}{\kappa^2\tau} - \frac{2}{\kappa^3\tau} \kappa'^2 + \kappa^5 + \frac{\tau}{\kappa} + \frac{\sigma^2}{\kappa\tau} \right] \cdot \ddot{\dot{X}} \\ \left[-\frac{\kappa'}{\kappa^2} \left(\frac{1}{\tau} \right)'' - \frac{\kappa''}{\kappa^2} \left(\frac{1}{\tau} \right)' + \frac{2\kappa'^2}{\kappa^3} \left(\frac{1}{\tau} \right)' + \kappa \left(\frac{1}{\tau} \right)' + 2\kappa'^2 \kappa \left(\frac{1}{\kappa^4\tau} \right) + \kappa^5 \left(\frac{1}{\kappa^4\tau} \right)' \right] \cdot \ddot{\dot{X}} \\ - \frac{2\kappa'\kappa''}{\kappa^3\tau} + \frac{\kappa'\sigma}{\tau} + \left(\frac{\tau}{\kappa} \right)' + \frac{\sigma^2}{\kappa\tau} - \kappa^2 \kappa'' \left(\frac{1}{\kappa^4\tau} \right)' - \frac{\sigma^2 \kappa'}{\kappa\tau} \\ \left[\kappa \left(\frac{1}{\tau} \right)'' + \kappa' \left(\frac{1}{\tau} \right)'' + \kappa' \left(\frac{1}{\tau} \right)' + \kappa^4 \kappa' \left(\frac{1}{\kappa^4\tau} \right)' + \frac{4\kappa'^2}{\kappa\tau} + \frac{\kappa''}{\tau} + \frac{\sigma^2 \kappa'}{\tau} \right] \cdot \dot{X} \end{array} \right\} = 0. \quad (12)$$

The formula (12) proves the theorem as desired. \square

§4. A Characterization of Inclined Curves in E^4

Theorem 4.1 Let $\alpha : I \subset R \rightarrow E^4$ be an unit speed regular curve with curvatures $\kappa \neq 0, \tau \neq 0$ and $\sigma \neq 0$ in E^4 . α is an inclined curve if and only if

$$H_1^2 + H_2^2 = \text{constant}, \quad (13)$$

where H_1 and H_2 are harmonic curvatures.

Proof Let α be an regular inclined curve in E^4 . In this case, we can write

$$\frac{\kappa}{\tau} = A. \cos \int_0^s \sigma ds. + B. \sin \int_0^s \sigma ds, \quad (14)$$

where $A, B \in R$. If we differentiate (14) respect to s , we get

$$\frac{1}{\sigma} \frac{d}{ds} \left(\frac{\kappa}{\tau} \right) = -A. \sin \int_0^s \sigma ds. + B. \cos \int_0^s \sigma ds. \quad (15)$$

Similarly, one more differentiating (15) respect to s , we have

$$\frac{d}{ds} \left[\frac{1}{\sigma} \frac{d}{ds} \left(\frac{\kappa}{\tau} \right) \right] = -A\sigma \sin \int_0^s \sigma ds. - B\sigma \cos \int_0^s \sigma ds. \quad (16)$$

Using notations $\sigma H_1 = \sigma \frac{\kappa}{\tau}$ and $\frac{dH_2}{ds}$ in (16), we find

$$\sigma H_1 + \frac{dH_2}{ds} = 0. \quad (17)$$

Multiplying both sides of (17) with $\frac{1}{\sigma} H_1' = H_2$, we obtain

$$H_1 H_1' + H_2 H_2' = 0. \quad (18)$$

The formula (18) yields that

$$H_1^2 + H_2^2 = \text{constant}. \quad (19)$$

Conversely, let relation (19) hold. Differentiating (19) respect to s , we know

$$H_1 H_1' + H_2 H_2' = 0. \quad (20)$$

Similarly differentiating of expressions of harmonic curvatures and using these in (20), we have the following differential equation

$$\frac{1}{\sigma^2} H_1'' + \frac{1}{\sigma} \left(\frac{1}{\sigma} \right)' H_1' + H_1 = 0. \quad (21)$$

Using an exchange variable $t = \int_0^s \sigma ds$ in (20),

$$\ddot{H}_1 + H_1 = 0. \quad (22)$$

Here, the notation \ddot{H}_1 indicates derivative of H_1 according to t . Solution of (22) follows that

$$H_1 = A \cos t + B \sin t, \quad (23)$$

where $A, B \in \mathbb{R}$. Therefore, we write that

$$\frac{\kappa}{\tau} = A \cdot \cos \int_0^s \sigma ds + B \cdot \sin \int_0^s \sigma ds. \quad (24)$$

By Theorem 2.1, (24) implies that α is an inclined curve in E^4 .

Acknowledgements The third author would like to thank TUBITAK-BIDEB for their financial supports during his Ph.D. studies.

References

- [1] A. Magden, Characterizations of some Special Curves in E^4 , Dissertation, Dept.Math Ataturk University, Erzurum, Turkey, 1990.
- [2] A. Sabuncuoglu and H.H.Hacisalihoglu, On Higher Curvature of a Curve, *Communications de la Fac. Sci. Uni. Ankara*, **24** (5):33-46, (1975).
- [3] H. Gluck, Higher Curvatures of Curves in Euclidean Space, *Amer. Math. Monthly*, 73:699-704, (1966).
- [4] H.H.Hacisalihoglu, Differential Geometry I, Ankara University Faculty of Science Press, 2000.
- [5] L.F.Mao, Pseudo-manifold geometries with applications, *International J.Math. Combin.*, Vol.1(2007), No.1, 45-58.

The Upper and Forcing Vertex Detour Numbers of a Graph

A.P. Santhakumaran

Department of Mathematics of St.Xavier's College (Autonomous),
Palayamkottai - 627 002, Tamil Nadu, India.

and

P.Titus

Department of Mathematics of St.Xavier's Catholic College of Engineering,
Chunkankadai - 629 807, Tamil Nadu, India.
E-mail: apskumar1953@yahoo.co.in, titusvino@yahoo.com

Abstract: For any vertex x in a connected graph G of order $p \geq 2$, a set $S \subseteq V(G)$ is an x -detour set of G if each vertex $v \in V(G)$ lies on an $x - y$ detour for some element y in S . The minimum cardinality of an x -detour set of G is defined as the x -detour number of G , denoted by $d_x(G)$. An x -detour set of cardinality $d_x(G)$ is called a d_x -set of G . An x -detour set S_x is called a minimal x -detour set if no proper subset of S_x is an x -detour set. The upper x -detour number, denoted by $d_x^+(G)$, is defined as the maximum cardinality of a minimal x -detour set of G . We determine bounds for it and find the same for some special classes of graphs. For any three positive integers a, b and n with $a \geq 2$ and $a \leq n \leq b$, there exists a connected graph G with $d_x(G) = a$, $d_x^+(G) = b$ and a minimal x -detour set of cardinality n . A subset T of a minimum x -detour set S_x of G is an x -forcing subset for S_x if S_x is the unique minimum x -detour set containing T . An x -forcing subset for S_x of minimum cardinality is a minimum x -forcing subset of S_x . The forcing x -detour number of S_x , denoted by $f_{dx}(S_x)$, is the cardinality of a minimum x -forcing subset for S_x . The forcing x -detour number of G is $f_{dx}(G) = \min \{f_{dx}(S_x)\}$, where the minimum is taken over all minimum x -detour sets S_x in G . It is shown that for any three positive integers a, b and c with $2 \leq a \leq b \leq c$, there exists a connected graph G with $f_{dx}(G) = a$, $d_x(G) = b$ and $d_x^+(G) = c$ for some vertex x in G .

Key Words: detour, vertex detour number, upper vertex detour number, forcing vertex detour number.

AMS(2000): 05C12.

§1. Introduction

By a graph $G = (V, E)$ we mean a finite undirected connected graph without loops or multiple edges. The order and size of G are denoted by p and q respectively. For basic graph theoretic

¹Received March 2, 2008. Accepted April 29, 2008.

terminology we refer to Harary [6]. For vertices x and y in a connected graph G , the *distance* $d(x, y)$ is the length of a shortest $x - y$ path in G . An $x - y$ path of length $d(x, y)$ is called an $x - y$ *geodesic*. The *closed interval* $I[x, y]$ consists of all vertices lying on some $x - y$ geodesic of G , while for $S \subseteq V$, $I[S] = \bigcup_{x, y \in S} I[x, y]$. A set S of vertices is a *geodetic set* if $I[S] = V$, and the minimum cardinality of a geodetic set is the *geodetic number* $g(G)$. A geodetic set of cardinality $g(G)$ is called a g -*set*. The geodetic number of a graph was introduced in [1,7] and further studied in [3].

The concept of vertex geodomination number was introduced by Santhakumaran and Titus in [8] and further studied in [9]. Let x be a vertex of a connected graph G . A set S of vertices of G is an x -*geodominating set* of G if each vertex v of G lies on an $x - y$ geodesic in G for some element y in S . The minimum cardinality of an x -geodominating set of G is defined as the x -*geodomination number* of G and is denoted by $g_x(G)$. An x -geodominating set of cardinality $g_x(G)$ is called a g_x -*set*. The connected vertex geodomination number was introduced and studied by Santhakumaran and Titus in [11]. A *connected x -geodominating set* of G is an x -geodominating set S such that the subgraph $G[S]$ induced by S is connected. The minimum cardinality of a connected x -geodominating set of G is the *connected x -geodomination number* of G and is denoted by $cg_x(G)$. A connected x -geodominating set of cardinality $cg_x(G)$ is called a cg_x -*set* of G .

For vertices x and y in a connected graph G , the *detour distance* $D(x, y)$ is the length of a longest $x - y$ path in G . An $x - y$ path of length $D(x, y)$ is called an $x - y$ *detour*. The closed interval $I_D[x, y]$ consists of all vertices lying on some $x - y$ detour of G , while for $S \subseteq V$, $I_D[S] = \bigcup_{x, y \in S} I_D[x, y]$. A set S of vertices is a *detour set* if $I_D[S] = V$, and the minimum cardinality of a detour set is the *detour number* $dn(G)$. A detour set of cardinality $dn(G)$ is called a *minimum detour set*. The detour number of a graph was introduced in [4] and further studied in [5].

The concept of vertex detour number was introduced by Santhakumaran and Titus in [10]. Let x be a vertex of a connected graph G . A set S of vertices of G is an x -*detour set* if each vertex v of G lies on an $x - y$ detour in G for some element y in S . The minimum cardinality of an x -detour set of G is defined as the x -*detour number* of G and is denoted by $d_x(G)$. An x -detour set of cardinality $d_x(G)$ is called a d_x -*set* of G . A vertex v in a graph G is an x -*detour vertex* if v belongs to every minimum x -detour set of G . The connected x -detour number was introduced and studied by Santhakumaran and Titus in [12]. A *connected x -detour set* of G is an x -detour set S such that the subgraph $G[S]$ induced by S is connected. The minimum cardinality of a connected x -detour set of G is the *connected x -detour number* of G and is denoted by $cd_x(G)$. A connected x -detour set of cardinality $cd_x(G)$ is called a cd_x -*set* of G .

For the graph G given in Fig.1.1, the minimum vertex detour sets, the vertex detour numbers, the minimum connected vertex detour sets and the connected vertex detour numbers are given in Table 1.1. An elaborate study of results in vertex detour number with several interesting applications is given in [10].

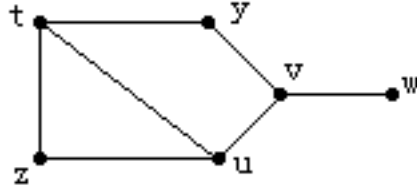

Fig.1.1

Vertex x	d_x -sets	$d_x(G)$	cd_x -sets	$cd_x(G)$
t	$\{y, w\}, \{z, w\}, \{u, w\}$	2	$\{y, v, w\}, \{u, v, w\}$	3
y	$\{w\}$	1	$\{w\}$	1
z	$\{w\}$	1	$\{w\}$	1
u	$\{w\}$	1	$\{w\}$	1
v	$\{y, w\}, \{z, w\}, \{u, w\}$	2	$\{y, v, w\}, \{u, v, w\}$	3
w	$\{y\}, \{z\}, \{u\}$	1	$\{y\}, \{z\}, \{u\}$	1

Table 1.1

The following theorems will be used in the sequel.

Theorem 1.1([10]) *Let x be any vertex of a connected graph G .*

(i) *Every end-vertex of G other than the vertex x (whether x is end-vertex or not) belongs to every x -detour set.*

(ii) *No cutvertex of G belongs to any d_x -set.*

Theorem 1.2([10]) *Let G be a connected graph with cut vertices and let S_x be an x -detour set of G . Then every branch of G contains an element of $S_x \cup \{x\}$.*

Theorem 1.3([10]) *If G is a connected graph with k end-blocks, then $d_x(G) \geq k - 1$ for every vertex x in G . In particular, if x is a cut vertex of G , then $d_x(G) \geq k$.*

Theorem 1.4([10]) *Let T be a tree with number of end-vertices t . Then $d_x(T) = t - 1$ or $d_x(T) = t$ according as x is an end-vertex or not. In fact, if W is the set of all end-vertices of T , then $W - \{x\}$ is the unique d_x -set of T .*

Theorem 1.5([10]) *If G is the complete graph $K_n (n \geq 2)$, the n -cube $Q_n (n \geq 2)$, the cycle $C_n (n \geq 3)$, the wheel $W_n = K_1 + C_{n-1} (n \geq 4)$ or the complete bipartite graph $K_{m,n} (m, n \geq 2)$, then $d_x(G) = 1$ for every vertex x in G .*

Throughout the following G denotes a connected graph with at least two vertices.

§2. Minimal Vertex Detour Sets in a Graph

Definition 2.1 Let x be any vertex of a connected graph G . An x -detour set S_x is called a minimal x -detour set if no proper subset of S_x is an x -detour set. The upper x -detour number, denoted by $d_x^+(G)$, is defined as the maximum cardinality of a minimal x -detour set of G .

It is clear from the definition that for any vertex x in G , x does not belong to any minimal x -detour set of G .

Example 2.2 For the graph G given in Fig.2.1, the minimum vertex detour sets, the minimum vertex detour numbers, the minimal vertex detour sets and the upper vertex detour numbers are given in Table 2.1.

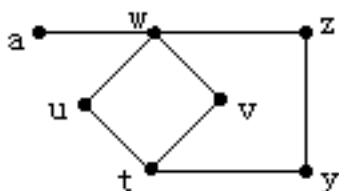

Fig.2.1

Vertex x	Minimum x -detour sets	$d_x(G)$	Minimal x -detour sets	$d_x^+(G)$
t	$\{a, y\}, \{a, z\}$	2	$\{a, u, v\}, \{a, y\}, \{a, z\}$	3
y	$\{a, t\}, \{a, z\}, \{a, u\}, \{a, v\}$	2	$\{a, t\}, \{a, z\}, \{a, u\}, \{a, v\}$	2
z	$\{a\}$	1	$\{a\}$	1
u	$\{a, y\}, \{a, z\}, \{a, v\}$	2	$\{a, y\}, \{a, z\}, \{a, v\}$	2
v	$\{a, y\}, \{a, z\}, \{a, u\}$	2	$\{a, y\}, \{a, z\}, \{a, u\}$	2
w	$\{a, z\}$	2	$\{a, z\}, \{a, t, y\}, \{a, y, u\},$ $\{a, y, v\}, \{a, u, v\}$	3
a	$\{z\}$	1	$\{z\}, \{t, y\}, \{y, u\}, \{y, v\}, \{u, v\}$	2

Table 2.1

Note 2.3 For any vertex x in a connected graph G , every minimum x -detour set is a minimal x -detour set, but the converse is not true. For the graph G given in Figure 2.1, $\{a, u, v\}$ is a minimal t -detour set but it is not a minimum t -detour set of G .

Theorem 2.4 Let x be any vertex of a connected graph G .

- (i) Every end-vertex of G other than the vertex x (whether x is end-vertex or not) belongs to every minimal x -detour set.
- (ii) No cut vertex of G belongs to any minimal x -detour set.

Proof (i) Let x be any vertex of G . Since x does not belong to any minimal x -detour set, let $v \neq x$ be an end-vertex of G . Then v is the terminal vertex of an $x - v$ detour and v is not an internal vertex of any detour so that v belongs to every minimal x -detour set of G .

(ii) Let $y \neq x$ be a cut vertex of G . Let U and W be two components of $G - \{y\}$. For any vertex x in G , let S_x be a minimal x -detour set of G . Suppose that $x \in U$. Now, suppose that $S_x \cap W = \emptyset$. Let $w_1 \in W$. Then $w_1 \notin S_x$. Since S_x is an x -detour set, there exists an element z in S_x such that w_1 lies in some $x - z$ detour $P : x = z_0, z_1, \dots, w_1, \dots, z_n = z$ in G . Since $S_x \cap W = \emptyset$ and y is a cut vertex of G , it follows that the $x - w_1$ subpath of P and the $w_1 - z$ subpath of P both contain y so that P is not a path in G . Hence $S_x \cap W \neq \emptyset$. Let $w_2 \in S_x \cap W$. Then $w_2 \neq y$ so that y is an internal vertex of an $x - w_2$ detour. If $y \in S_x$, let $S = S_x - \{y\}$. It is clear that every vertex that lies on an $x - y$ detour also lies on an $x - w_2$ detour. Hence it follows that S is an x -detour set of G , which is a contradiction to S_x a minimal x -detour set of G . Thus y does not belong to any minimal x -detour set of G . Similarly if $x \in W$, then y does not belong to any minimal x -detour set of G . \square

The following theorem is an easy consequence of the definitions of the minimum vertex detour number and the upper vertex detour number of a graph.

Theorem 2.5 For any non-trivial tree T with k end vertices, $d_x(T) = d_x^+(T) = k$ or $k - 1$ according as x is a cut vertex or not.

(ii) For any vertex x in the complete graph K_p , $d_x(K_p) = d_x^+(K_p) = 1$.

(iii) For any vertex x in the complete bipartite graph $K_{m,n}$, $d_x(K_{m,n}) = d_x^+(K_{m,n}) = 1$ if $m, n \geq 2$.

(iv) For any vertex x in the wheel W_p , $d_x(W_p) = d_x^+(W_p) = 1$. \square

Theorem 2.6 For any vertex x in G , $1 \leq d_x(G) \leq d_x^+(G) \leq p - 1$.

Proof It is clear from the definition of minimum x -detour set that $d_x(G) \geq 1$. Since every minimum x -detour set is a minimal x -detour set, $d_x(G) \leq d_x^+(G)$. Also, since the vertex x does not belong to any minimal x -detour set, it follows that $d_x^+(G) \leq p - 1$. \square

Remark 2.7 For the complete graph K_p , $d_x(K_p) = 1$ for every vertex x in K_p . For the graph G given in Figure 2.1, $d_y(G) = d_y^+(G)$. Also, for the graph K_2 , $d_x^+(K_2) = p - 1$ for every vertex x in K_2 . All the inequalities in Theorem 2.6 can be strict. For the graph G given in Figure 2.1, $d_w(G) = 2$, $d_w^+(G) = 3$ and $p = 7$ so that $1 < d_w(G) < d_w^+(G) < p - 1$.

Theorem 2.8 For every pair a, b of integers with $1 \leq a \leq b$, there is a connected graph G with $d_x(G) = a$ and $d_x^+(G) = b$ for some vertex x in G .

Proof For $a = b = 1$, $K_p (p \geq 2)$ has the desired properties. For $a = b$ with $b \geq 2$, let G be any tree of order $p \geq 3$ with b end-vertices. Then by Theorem 2.5(i), $d_x(G) = d_x^+(G) = b$ for any cut vertex x in G . Assume that $1 \leq a < b$. Let $F = (K_2 \cup (b - a + 2)K_1) + \overline{K}_2$, where let $Z = V(K_2) = \{z_1, z_2\}$, $Y = V((b - a + 2)K_1) = \{x, y_1, y_2, \dots, y_{b-a+1}\}$ and $U = V(\overline{K}_2) = \{u_1, u_2\}$. Let G be the graph obtained from F by adding $a - 1$ new vertices w_1, w_2, \dots, w_{a-1} and joining each w_i to x . The graph G is shown in Fig.2.2. Let $W = \{w_1, w_2, \dots, w_{a-1}\}$ be the set

of end vertices of G .

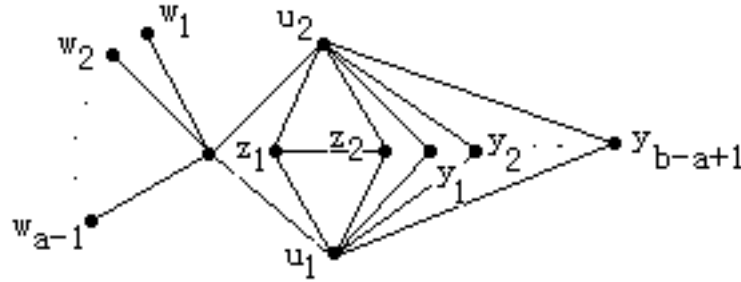

Fig.2.2

First, we show that $d_x(G) = a$ for the vertex x in G . By Theorem 1.3, $d_x(G) \geq a$. On the other hand, let $S = \{w_1, w_2, \dots, w_{a-1}, z_1\}$. Then $D(x, z_1) = 5$ and each vertex of F lies on an $x - z_1$ detour. Hence S is an x -detour set of G and so $d_x(G) \leq |S| = a$. Therefore, $d_x(G) = a$. Also, we observe that a minimum x -detour set of G is formed by taking all the end vertices and exactly one vertex from Z .

Next, we show that $d_x^+(G) = b$. Let $M = \{w_1, w_2, \dots, w_{a-1}, y_1, y_2, \dots, y_{b-a+1}\}$. It is clear that M is an x -detour set of G . We claim that M is a minimal x -detour set of G . Assume, to the contrary, that M is not a minimal x -detour set. Then there is a proper subset T of M such that T is an x -detour set of G . Let $s \in M$ and $s \notin T$. By Theorem 1.1(i), clearly $s = y_i$, for some $i = 1, 2, \dots, b - a + 1$. For convenience, let $s = y_1$. Since y_1 does not lie on any $x - y_j$ detour where $j = 2, 3, \dots, b - a + 1$, it follows that T is not an x -detour set of G , which is a contradiction. Thus M is a minimal x -detour set of G and so $d_x^+(G) \geq |M| = b$.

Now we prove that $d_x^+(G) = b$. Suppose that $d_x^+(G) > b$. Let N be a minimal x -detour set of G with $|N| > b$. Then there exists at least one vertex, say $v \in N$ such that $v \notin M$. Thus $v \in \{u_1, u_2, z_1, z_2\}$.

Case 1. $v \in \{z_1, z_2\}$, say $v = z_1$. Clearly $W \cup \{z_1\}$ is an x -detour set of G and also it is a proper subset of N , which is a contradiction to N a minimal x -detour set of G .

Case 2. $v \in \{u_1, u_2\}$, say $v = u_1$. Suppose $u_2 \notin N$. Then there is at least one y in Y such that $y \in N$. Clearly, $D(x, u_1) = 4$ and the only vertices of any $x - u_1$ detour are x, z_1, z_2, u_1 and u_2 . Also x, u_2, z_1, z_2, u_1, y is an $x - y$ detour and hence $N - \{u_1\}$ is an x -detour set, which is a contradiction to N a minimal x -detour set of G . Suppose $u_2 \in N$. It is clear that the only vertices of any $x - u_1$ or $x - u_2$ detour are x, u_1, u_2, z_1 and z_2 . Since $u_1, u_2 \in N$, it follows that both $N - \{u_1\}$ and $N - \{u_2\}$ are x -detour sets, which is a contradiction to N a minimal x -detour set of G .

Thus there is no minimal x -detour set N of G with $|N| > b$. Hence $d_x^+(G) = b$. □

Remark 2.9 The graph G of Figure 2.2 contains exactly three minimal x -detour sets, namely $W \cup \{z_1\}$, $W \cup \{z_2\}$ and $W \cup (Y - \{x\})$. This example shows that there is no "Intermediate Value Theorem" for minimal x -detour sets, that is, if n is an integer such that $d_x(G) < n < d_x^+(G)$, then there need not exist a minimal x -detour set of cardinality n in G .

Theorem 2.10 For any three positive integers a, b and n with $a \geq 2$ and $a \leq n \leq b$, there exists a connected graph G with $d_x(G) = a$, $d_x^+(G) = b$ and a minimal x -detour set of cardinality n .

Proof We consider four cases.

Case 1. Suppose $a = n = b$.

Let G be any tree of order $p \geq 3$ with a end vertices. Then by Theorem 2.5(i), $d_x(G) = d_x^+(G) = a$ for any cut vertex x in G and the set of all end vertices in G is a minimal x -detour set with cardinality n by Theorem 2.4.

Case 2. Suppose $a = n < b$. For the graph G given in Figure 2.2 of Theorem 2.8, it is proved that $d_x(G) = a$, $d_x^+(G) = b$ and $S = \{w_1, w_2, \dots, w_{a-1}, z_1\}$ is a minimal x -detour set of cardinality n .

Case 3. Suppose $a < n = b$. For the graph G given in Figure 2.2 of Theorem 2.8, it is proved that $d_x(G) = a$, $d_x^+(G) = b$ and $S = \{w_1, w_2, \dots, w_{a-1}, y_1, y_2, \dots, y_{b-a+1}\}$ is a minimal x -detour set of cardinality n .

Case 4. Suppose $a < n < b$. Let $l = n - a + 1$ and $m = b - n + 1$.

Let $F_1 = (K_2 \cup lK_1) + \overline{K}_2$, where let $Z_1 = V(K_2) = \{z_1, z_2\}$, $Y_1 = V(lK_1) = \{y_1, y_2, \dots, y_l\}$ and $U_1 = V(\overline{K}_2) = \{u_1, u_2\}$. Similarly let $F_2 = (K_2 \cup mK_1) + \overline{K}_2$, where let $Z_2 = V(K_2) = \{z_3, z_4\}$, $Y_2 = V(mK_1) = \{x_1, x_2, \dots, x_m\}$ and $U_2 = V(\overline{K}_2) = \{u_3, u_4\}$. Let $K_{1,a-2}$ be the star at the vertex x and let $W = \{w_1, w_2, \dots, w_{a-2}\}$ be the set of end vertices of $K_{1,a-2}$. Let G be the graph obtained from $K_{1,a-2}$, F_1 and F_2 by joining the vertex x of $K_{1,a-2}$ to the elements of U_1 and U_2 . The graph G is shown in Fig.2.3. It follows from Theorem 2.4(i) that for the vertex x , W is a subset of every minimal x -detour set of G .

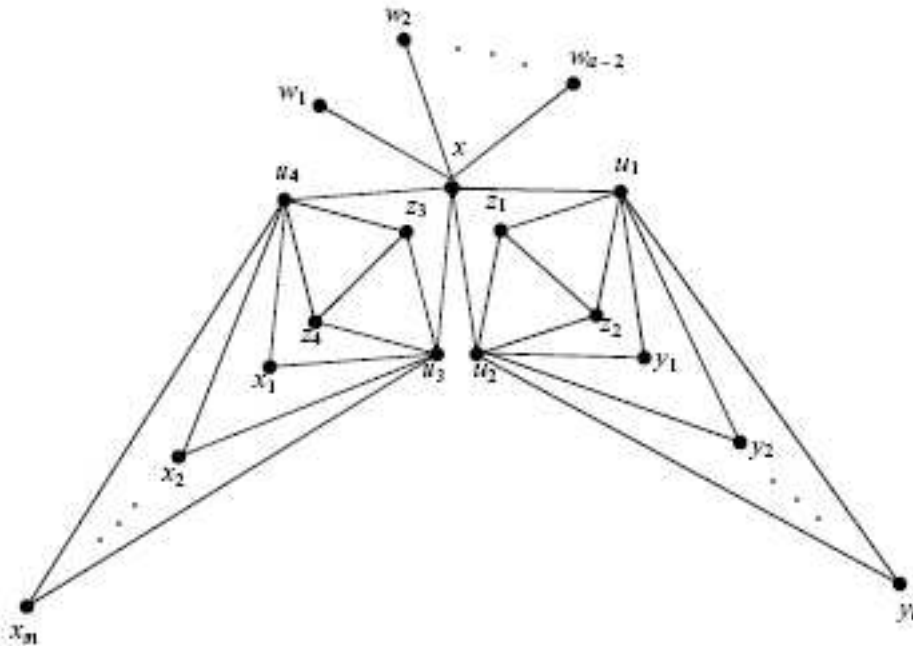

Fig.2.3

First, we show that $d_x(G) = a$ for the vertex x in G . By Theorem 1.3, $d_x(G) \geq a$. On the

other hand, let $S = \{w_1, w_2, \dots, w_{a-2}, z_1, z_3\}$. Then $D(x, z_1) = 5$ and each vertex of F_1 lies on an $x - z_1$ detour. Similarly, $D(x, z_3) = 5$ and each vertex of F_2 lies on an $x - z_3$ detour. Hence S is an x -detour set of G and so $d_x(G) \leq |S| = a$. Therefore, $d_x(G) = a$.

Next, we show that $d_x^+(G) = b$. Let $M = W \cup Y_1 \cup Y_2$. It is clear that M is an x -detour set of G . We claim that M is a minimal x -detour set of G . Assume, to the contrary, that M is not a minimal x -detour set. Then there is a proper subset T of M such that T is an x -detour set of G . Let $s \in M$ and $s \notin T$. By Theorem 1.1(i), clearly $s \in Y_1 \cup Y_2$. For convenience, let $s = y_1$. Since y_1 does not lie on any $x - y_j$ detour, where $j = 2, 3, \dots, l$ and y_1 does not lie on any $x - x_j$ detour, where $j = 1, 2, \dots, m$, it follows that T is not an x -detour set of G , which is a contradiction. Thus M is a minimal x -detour set of G and so $d_x^+(G) \geq |M| = b$.

Now, we prove that $d_x^+(G) = b$. Suppose that $d_x^+(G) > b$. Let N be a minimal x -detour set of G with $|N| > b$. Then there exists at least one vertex, say $v \in N$ such that $v \notin M$. Thus, $v \in \{u_1, u_2, u_3, u_4, z_1, z_2, z_3, z_4\}$.

Subcase 1. Suppose $v \in \{z_1, z_2\}$, say $v = z_1$. Clearly, every vertex of F_1 lies on an $x - z_1$ detour and so $(N - V(F_1)) \cup \{v\}$ is an x -detour set of G and it is a proper subset of N , which is a contradiction to N a minimal x -detour set of G .

Subcase 2. Suppose $v \in \{z_3, z_4\}$. It is similar to Subcase 1.

Subcase 3. Suppose $v \in \{u_1, u_2\}$, say $v = u_1$. Suppose $u_2 \notin N$. Then there is at least one element y in Y_1 such that $y \in N$. Clearly, $D(x, u_1) = 4$ and the only vertices of any $x - u_1$ detour are x, z_1, z_2, u_1 and u_2 . Also x, u_2, z_1, z_2, u_1, y is an $x - y$ detour and hence $N - \{u_1\}$ is an x -detour set, which is a contradiction to N a minimal x -detour set of G . Suppose $u_2 \in N$. It is clear that the only vertices of any $x - u_1$ or $x - u_2$ detour are x, u_1, u_2, z_1 and z_2 . Since $u_1, u_2 \in N$, it follows that both $N - \{u_1\}$ and $N - \{u_2\}$ are x -detour sets, which is a contradiction to N a minimal x -detour set of G .

Subcase 4. Suppose $v \in \{u_3, u_4\}$. It is similar to Subcase 3.

Thus there is no minimal x -detour set N of G with $|N| > b$. Hence $d_x^+(G) = b$.

Now, we show that there is a minimal x -detour set of cardinality n . Let $S = \{w_1, w_2, \dots, w_{a-2}, z_3, y_1, y_2, \dots, y_l\}$. It is clear that S is an x -detour set of G . We claim that S is a minimal x -detour set of G . Assume, to the contrary, that S is not a minimal x -detour set. Then there is a proper subset T of S such that T is an x -detour set of G . Let $s \in S$ and $s \notin T$. By Theorem 1.1(i) and Theorem 1.2, clearly $s = y_i$ for some $i = 1, 2, \dots, l$. For convenience, let $s = y_1$. Since y_1 does not lie on any $x - y_j$ detour where $j = 2, 3, \dots, l$, it follows that T is not an x -detour set of G , which is a contradiction. Thus S is a minimal x -detour set of G with cardinality $|S| = n$. Hence we obtain the theorem. \square

§3. Vertex Forcing Subsets in Vertex Detour Sets of a Graph

Let x be any vertex of a connected graph G . Although G contains a minimum x -detour set there are connected graphs which may contain more than one minimum x -detour set. For example the graph G given in Fig. 2.1 contains more than one minimum x -detour set. For each minimum x -detour set S_x in a connected graph G there is always some subset T of S_x that

uniquely determines S_x as the minimum x -detour set containing T . Such sets are called "vertex forcing subsets" and we discuss these sets in this section.

Definition 3.1 Let x be any vertex of a connected graph G and let S_x be a minimum x -detour set of G . A subset $T \subseteq S_x$ is called an x -forcing subset for S_x if S_x is the unique minimum x -detour set containing T . An x -forcing subset for x of minimum cardinality is a minimum x -forcing subset of S_x . The forcing x -detour number of S_x , denoted by $f_{dx}(S_x)$, is the cardinality of a minimum x -forcing subset for S_x . The forcing x -detour number of G is $f_{dx}(G) = \min \{f_{dx}(S_x)\}$, where the minimum is taken over all minimum x -detour sets S_x in G .

Example 3.2 For the graph G given in Figure 1.1, the minimum x -detour sets, the x -detour numbers and the forcing x -detour numbers for every vertex x in G are given in Table 3.1.

Vertex x	Minimum x -detour sets	x -detour number	Forcing x -detour number
t	$\{y, w\}, \{z, w\}, \{u, w\}$	2	1
y	$\{w\}$	1	0
z	$\{w\}$	1	0
u	$\{w\}$	1	0
v	$\{y, w\}, \{z, w\}, \{u, w\}$	2	1
w	$\{y\}, \{z\}, \{u\}$	1	1

Table 3.1

Theorem 3.3 any vertex x in a connected graph G , $0 \leq f_{dx}(G) \leq d_x(G)$.

Proof Let x be any vertex of G . It is clear from the definition of $f_{dx}(G)$ that $f_{dx}(G) \geq 0$. Let S_x be any minimum x -detour set of G . Since $f_{dx}(S_x) \leq d_x(G)$ and since $f_{dx}(G) = \min \{f_{dx}(S_x) : S_x \text{ is a minimum } x\text{-detour set in } G\}$, it follows that $f_{dx}(G) \leq d_x(G)$. Thus $0 \leq f_{dx}(G) \leq d_x(G)$. \square

Remark 3.4 The bounds in Theorem 3.3 are sharp. For the graph G given in Figure 1.1, $f_{dy}(G) = 0$ and $f_{dw}(G) = d_w(G) = 1$. Also, the inequality in Theorem 3.3 can be strict. For the same graph G given in Figure 1.1, $0 < f_{dv}(G) < d_v(G)$.

The following theorem characterizes those graphs G having $f_{dx}(G) = 0$, $f_{dx}(G) = 1$ or $f_{dx}(G) = d_x(G)$. Since the proof of this theorem is straight forward, we omit it.

Theorem 3.5 Let x be any vertex of a graph G . Then

- (i) $f_{dx}(G) = 0$ if and only if G has a unique minimum x -detour set.
- (ii) $f_{dx}(G) = 1$ if and only if G has at least two minimum x -detour sets, one of which is a unique minimum x -detour set containing one of its elements.
- (iii) $f_{dx}(G) = d_x(G)$ if and only if no minimum x -detour set of G is the unique minimum x -detour set containing any of its proper subsets.

Theorem 3.6 *Let x be any vertex of a connected graph G and let S_x be any minimum x -detour set of G . Then*

- (i) *no cut vertex of G belongs to any minimum x -forcing subset of S_x .*
- (ii) *no x -detour vertex of G belongs to any minimum x -forcing subset of S_x .*

Proof Let x be any vertex of a connected graph G and let S_x be any minimum x -detour set of G .

(i) Since any minimum x -forcing subset of S_x is a subset of S_x , the result follows from Theorem 1.1(ii).

(ii) Let v be an x -detour vertex of G . Then v belongs to every minimum x -detour set of G . Let $T \subseteq S_x$ be any minimum x -forcing subset for any minimum x -detour set S_x of G . We claim that $v \notin T$. If $v \in T$, then $T' = T - \{v\}$ is a proper subset of T such that S_x is the unique minimum x -detour set containing T' so that T' is an x -forcing subset for S_x with $|T'| < |T|$, which is a contradiction to T a minimum x -forcing subset for S_x . \square

Corollary 3.7 *Let x be any vertex of a connected graph G . If G contains k end-vertices, then $f_{dx}(G) \leq d_x(G) - k + 1$.*

Proof This follows from Theorem 1.1(i) and Theorem 3.6(ii). \square

Remark 3.8 The bound for $f_{dx}(G)$ in Corollary 3.7 is sharp. For a non-trivial tree T with k end vertices, $f_{dx}(T) = 0 = d_x(T) - k + 1$ for any end vertex x in T .

Theorem 3.9 (i) *If T is a non-trivial tree, then $f_{dx}(T) = 0$ for every vertex x in T .*

(ii) *If G is the complete graph K_n ($n \geq 3$), the n -cube Q_n ($n \geq 2$), the cycle C_n ($n \geq 3$), the wheel $W_n = K_1 + C_{n-1}$ ($n \geq 4$) or the complete bipartite graph $K_{m,n}$ ($m, n \geq 2$), then $f_{dx}(G) = d_x(G) = 1$ for every vertex x in G .*

Proof (i) This follows from Theorem 1.4 and Theorem 3.5(i).

(ii) For each of the graphs in (ii) it is easily seen that there is more than one minimum x -detour set for any vertex x . Hence it follows from Theorem 3.5(i) that $f_{dx}(G) \neq 0$ for each of the graphs. Also, by Theorem 3.3, $f_{dx}(G) \leq d_x(G)$. Now it follows from Theorem 1.5 that $f_{dx}(G) = d_x(G) = 1$ for each of the graphs. \square

Theorem 3.10 *For any vertex x in a connected graph G , $0 \leq f_{dx}(G) \leq d_x(G) \leq d_x^+(G)$.*

Proof This follows from Theorems 2.6 and 3.3. \square

The following theorem gives a realization for the parameters $f_{dx}(G)$, $d_x(G)$ and $d_x^+(G)$.

Theorem 3.11 *For any three positive integers a, b and c with $2 \leq a \leq b \leq c$, there exists a connected graph G with $f_{dx}(G) = a$, $d_x(G) = b$ and $d_x^+(G) = c$ for some vertex x in G .*

Proof For each integer i with $1 \leq i \leq a - 1$, let F_i be a copy of K_2 , where v_i and v'_i are the vertices of F_i . Let $K_{1,b-a}$ be the star at the vertex x and let $U = \{u_1, u_2, \dots, u_{b-a}\}$ be the set of end vertices of $K_{1,b-a}$. Let H be the graph obtained from $K_{1,b-a}$ by joining the vertex x to the

vertices of F_i ($1 \leq i \leq a-1$). Let $K = (K_2 \cup (c-b+1)K_1) + \overline{K}_2$, where $Z = V(K_2) = \{z_1, z_2\}$, $Y = V((c-b+1)K_1) = \{y_1, y_2, \dots, y_{c-b+1}\}$ and $X = V(\overline{K}_2) = \{x_1, x_2\}$. Let G be the graph obtained from H and K by joining x with x_1 and x_2 . The graph G is shown in Fig.3.1.

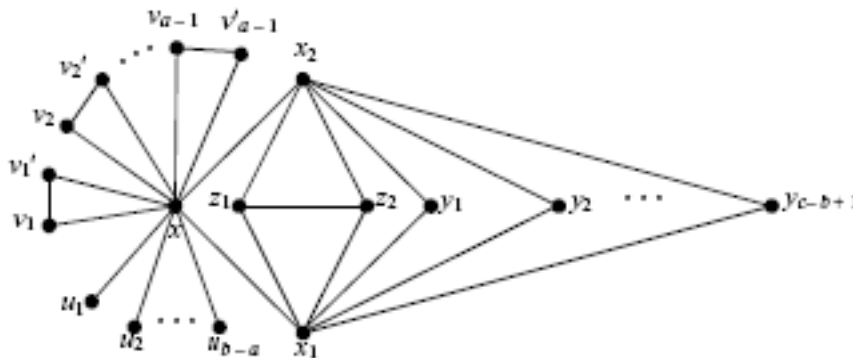

Fig.3.1

Step I. First, we show that $d_x(G) = b$ for the vertex x in G . By Theorem 1.3, $d_x(G) \geq b$. On the other hand, if $c - b + 1 > 1$, let $S = \{u_1, u_2, \dots, u_{b-a}, v_1, v_2, \dots, v_{a-1}, z_1\}$ be the set formed by taking all the end vertices and exactly one vertex from each F_i and Z , and if $c - b + 1 = 1$, let $S = \{u_1, u_2, \dots, u_{b-a}, v_1, v_2, \dots, v_{a-1}, z_1\}$ be the set formed by taking all the end vertices and exactly one vertex from each F_i and $Z \cup \{y_1\}$. Then $D(x, z_1) = 5$ and each vertex of K lies on an $x - z_1$ detour and each vertex of F_i lies on an $x - v_i$ detour. Hence S is an x -detour set of G and so $d_x(G) \leq |S| = b$. Therefore, $d_x(G) = b$.

Step II. Now, we show that $f_{dx}(G) = a$. Since every minimum x -detour set of G contains U , exactly one vertex from each F_i ($1 \leq i \leq a-1$) and one vertex from Z or $Z \cup \{y_1\}$ according as $c > b$ or $c = b$ respectively, let $S = \{u_1, u_2, \dots, u_{b-a}, v_1, v_2, \dots, v_{a-1}, z_1\}$ be a minimum x -detour set of G and let $T \subseteq S$ be any minimum x -forcing subset of S . Then by Theorem 3.6(ii), $T \subseteq S - U$. Therefore, $|T| \leq a$. If $|T| < a$, then there is a vertex $y \in S - U$ such that $y \notin T$. Now there are two cases.

Case 1. Let $y \in \{v_1, v_2, \dots, v_{a-1}\}$, say $y = v_1$. Let $S' = (S - \{v_1\}) \cup \{v_1'\}$, where v_1' be the vertex of F_1 other than v_1 . Then $S' \neq S$ and S' is also a minimum x -detour set of G such that it contains T , which is a contraction to T an x -forcing subset of S .

Case 2. Let $y = z_1$. Then exactly similar to Case 1 we see that $|T| < a$ is not possible. Thus $|T| = a$ and so $f_{dx}(G) = a$.

Step III. Next, we show that $d_x^+(G) = c$. Let $M = \{u_1, u_2, \dots, u_{b-a}, v_1, v_2, \dots, v_{a-1}, y_1, y_2, \dots, y_{c-b+1}\}$. It is clear that M is an x -detour set of G . We claim that M is a minimal x -detour set of G . Assume, to the contrary, that M is not a minimal x -detour set. Then there is a proper subset T of M such that T is an x -detour set of G . Let $s \in M$ and $s \notin T$. By Theorem 1.2, clearly $s = y_i$ for some $i = 1, 2, \dots, c - b + 1$. For convenience, let $s = y_1$. Since y_1 does not lie on any $x - y_j$ detour where $j = 2, 3, \dots, c - b + 1$, it follows that T is not an x -detour set of G , which is a contradiction. Thus M is a minimal x -detour set of G and so $d_x^+(G) \geq |M| = c$. Now suppose $d_x^+(G) > c$. Let N be a minimal x -detour set of G with $|N| > c$. Then at least one

vertex $w \in N$ such that $w \notin M$. It is clear that every minimal x -detour set contains exactly one vertex from each F_i . Then by Theorem 2.4(i), $w \in \{x_1, x_2, z_1, z_2\}$.

Case 1. Let $w \in \{z_1, z_2\}$, say $w = z_1$. Since every vertex of K lies on an $x - z_1$ detour we have $(N - V(K)) \cup \{z_1\}$ is an x -detour set and it is a proper subset of N , which is a contradiction to N a minimal x -detour set of G .

Case 2. Let $w \in \{x_1, x_2\}$, say $w = x_1$. Suppose $x_2 \notin N$. Then there is at least one y in Y such that $y \in N$. Clearly, $D(x, x_1) = 4$ and the only vertices of any $x - x_1$ detour are x, z_1, z_2, x_1 and x_2 . Also x, x_2, z_1, z_2, x_1, y is an $x - y$ detour and hence $N - \{x_1\}$ is an x -detour set, which is a contradiction to N a minimal x -detour set of G . Suppose $x_2 \in N$. It is clear that the only vertices of any $x - x_1$ or $x - x_2$ detour are x, z_1, z_2, x_1 and x_2 . Since $x_1, x_2 \in N$, it follows that both $N - \{x_1\}$ and $N - \{x_2\}$ are x -detour sets, which is a contradiction to N a minimal x -detour set of G .

Thus there is no minimal x -detour set N of G with $|N| > c$. Hence $d_x^+(G) = c$. \square

References

- [1] F. Buckley, F. Harary, *Distance in Graphs*, Addison-Wesley, Redwood City, CA, (1990).
- [2] G. Chartrand, H. Escudro, P. Zang, Detour Distance in Graphs, *J. Combin. Math. Combin. Comput.*, 53(2005) 75-94.
- [3] G. Chartrand, F. Harary, P. Zhang, On the Geodetic Number of a Graph, *Networks*, 39 (2002) 1-6.
- [4] G. Chartrand, G.L. Johns, P. Zhang, The Detour number of a Graph, *Utilitas Mathematica*, 64 (2003) 97-113.
- [5] G. Chartrand, G.L. Johns, P. Zhang, On the Detour Number and Geodetic Number of a Graph, *Ars Combinatoria*, 72 (2004) 3-15.
- [6] F. Harary, *Graph Theory*, Addison-Wesley, 1969.
- [7] F. Harary, E. Loukakis, C. Tsouros, The geodetic number of a graph, *Math. Comput. Modeling*, 17(11)(1993), 87-95.
- [8] A.P. Santhakumaran, P. Titus, Vertex Geodomination in Graphs, *Bulletin of Kerala Mathematics Association*, Vol.2, No.2(2005), 45-57.
- [9] A.P. Santhakumaran, P. Titus, On the Vertex Geodomination Number of a Graph, *Ars Combinatoria* (To appear).
- [10] A.P. Santhakumaran, P. Titus, The Vertex Detour Number of a Graph, *AKCE International J. Graphs. Combin.*, 4, No.1, (2007) 99-112.
- [11] A.P. Santhakumaran, P. Titus, The Connected Vertex Geodomination Number of a Graph, *Communicated*.
- [12] A.P. Santhakumaran, P. Titus, The Connected Vertex Detour Number of a Graph, *Communicated*.

Science without religion is lame, religion without science is blind.

By Albert Einstein, an American scientist.

Author Information

Submission: Papers only in electronic form are considered for possible publication. Papers prepared in formats, viz., .tex, .dvi, .pdf, or.ps may be submitted electronically to one member of the Editorial Board for consideration in the **International Journal of Mathematical Combinatorics** (*ISSN 1937-1055*). An effort is made to publish a paper duly recommended by a referee within a period of 3 months. Articles received are immediately put the referees/members of the Editorial Board for their opinion who generally pass on the same in six week's time or less. In case of clear recommendation for publication, the paper is accommodated in an issue to appear next. Each submitted paper is not returned, hence we advise the authors to keep a copy of their submitted papers for further processing.

Abstract: Authors are requested to provide an abstract of not more than 250 words, latest Mathematics Subject Classification of the American Mathematical Society, Keywords and phrases. Statements of Lemmas, Propositions and Theorems should be set in italics and references should be arranged in alphabetical order by the surname of the first author in the following style:

Books

[4]K. Kawakubo, The Theory of Transformation Groups, Oxford University Press, New York, 1991.

Research papers

[8]K. K. Azad and Gunjan Agrawal, On the projective cover of an orbit space, *J. Austral. Math. Soc.* 46 (1989), 308-312.

[9]Kavita Srivastava, On singular H-closed extensions, *Proc. Amer. Math. Soc.* (to appear).

Figures: Figures should be sent as: fair copy on paper, whenever possible scaled to about 200%, or as EPS file. In addition, all figures and tables should be numbered and the appropriate space reserved in the text, with the insertion point clearly indicated.

Copyright: It is assumed that the submitted manuscript has not been published and will not be simultaneously submitted or published elsewhere. By submitting a manuscript, the authors agree that the copyright for their articles is transferred to the publisher, if and when, the paper is accepted for publication. The publisher cannot take the responsibility of any loss of manuscript. Therefore, authors are requested to maintain a copy at their end.

Proofs: One set of galley proofs of a paper will be sent to the author submitting the paper, unless requested otherwise, without the original manuscript, for corrections after the paper is accepted for publication on the basis of the recommendation of referees. Corrections should be restricted to typesetting errors. Authors are advised to check their proofs very carefully before return.

Reprints: One copy of the journal including his or her paper(s) are provided to the authors freely. Additional sets may be ordered at the time of proof correction.



Contents

The Characterization of Symmetric Primitive Matrices with Exponent $n - 2$
 BY JUNLIANG CAI 01

Characterizations of Some Special Space-like Curves in Minkowski Space-time
 BY MELIH TURGUT AND SUHA YILMAZ 17

Combinatorially Riemannian Submanifolds
 BY LINFAN MAO 23

Smarandache Half-Groups
 BY ARUN S.MUKTIBODH 46

On Smarandache Bryant Schneider Group of a Smarandache Loop
 BY T. G. JAÍYÉOLÁ 51

Some Properties of Nilpotent Lattice Matrices
 BY QIYI FAN 64

On the Crossing Number of the Join of Some 5-Vertex Graphs and P_n
 BY BO LI, JING WANG AND YUANQIU HUANG 70

Identities by L-summing Method (II)
 BY MEHDI HASSANI 78

On the Basis Number of the Direct Product of Theta Graphs with Cycles
 BY M.M.M. JARADAT and K.M.A.AL-SHORMAN 87

A Note on Differential Geometry of the Curves in E^4
 BY SUHA YILMAZ, SUUR NIZAMOGLU AND MELIH TURGUT 104

The Upper and Forcing Vertex Detour Numbers of a Graph
 BY A.P.SANTHAKUMARAN AND P.TITUS 109

