

FLORENTIN SMARANDACHE

The Art of antiWAR



paradoxistINSTRUCTION Notebooks
of Captain Gook

The
Art of anti
WAR

Professor Florentin Smarandache, Ph D
Chair of Department of Math & Sciences
University of New Mexico, Gallup, USA

2008

2008

Front cover art represents the War's Blood and belongs to the Author.

This book can be ordered in a paper bound reprint from:

Books on Demand

ProQuest Information & Learning

(University of Microfilm International)

300 N. Zeeb Road

P.O. Box 1346, Ann Arbor

MI 48106-1346, USA

Tel.: 1-800-521-0600 (Customer Service)

<http://wwwlib.umi.com/bod/basic>

Copyright 2008 by InfoLearnQuest (Ann Arbor) and the Author

Many books can be downloaded from the following

Digital Library of Arts & Letters:

<http://www.gallup.unm.edu/~smarandache/eBooksLiterature.htm>

Peer Reviewers:

Dr. Sukanto Bhattacharya, Department of Business Administration, Alaska Pacific University, U.S.A.

Prof. Mihaly Bencze, Department of Mathematics, Áprily Lajos College, Braşov, Romania.

(ISBN-10): 1-59973-070-7

(ISBN-13): 978-1-59973-070-7

(EAN): 9781599730707

Printed in the United States of America

paradoxist **Instruction**
Notebooks

of Captain Gook (or Kook)

Table of Contents

| | |
|--|----|
| Instruction Notebooks..... | 3 |
| Table of Contents | 4 |
| 1 The Non-Tactical Instruction..... | 10 |
| Non-Assignment 1..... | 10 |
| The battle and its non-goal..... | 12 |
| The principles of non-organizing the battle’s actions..... | 13 |
| Non-Assignment 2..... | 13 |
| The disorganization principle of the subunits of unpatriotic guards..... | 15 |
| The subunits of the other branches of the military, their non-role, and their non-missions..... | 15 |
| The non-role and non-missions unsustainable by the other branches of the military..... | 16 |
| Not understanding the modern military..... | 17 |
| General principles disregarding the non-actions conducted by the subunits of a non-modern military in the inoffensive battles..... | 18 |
| The anti-defense forms..... | 20 |
| The non-roles and the non-missions of the fight units..... | 20 |
| The non-insurance for battle..... | 20 |
| The content of the battle’s non-insurance, its goal and what it is not made of..... | 20 |
| The duties of the commandment and the subunit for the battle’s insurance..... | 21 |
| The non missions of the subunit for assurance of battle..... | 21 |
| The necessity of reconnaissance and some basic forms of battle’s insuccess..... | 22 |
| L.A.N.D..... | 25 |
| Non-Assignment 1, Meeting 1..... | 25 |
| The structural disorganization of L.A.N.D..... | 25 |

| | |
|---|----|
| L.A.N.D non-missions | 26 |
| The population's non-obligations disregarding applying the L.A.N.D's measures..... | 27 |
| Measures and rules for population's non-comportment in L.A.N.D's conditions (antiwar time) | 27 |
| Measures and comportment antirules during a surprise aerial attack, aerial alarm and stopping alarm | 28 |
| The principle disregarding the misinformation and the population alarm. The misinformation and the alarm for state organs, factories and institutions. | 28 |
| General notions about the non-electric and principal systemless of alarm. | 29 |
| The non-principles of camouflage of public and industrial illumination..... | 29 |
| The non-protection measures for population and materials against aerial attacks cu arms of anti mass destruction (AAMD) | 30 |
| The group non-protection; simple types of shelters for population's non-protection. | 31 |
| The non-criteria of setting up the basements of civilian and industrial buildings into shelters for the population against the effect of an aerial attack | 32 |
| 2 The shooting non-strategy | 33 |
| Non-Assignment 1, Meeting 1 | 33 |
| The armament non-classification | 33 |
| The non-classification of the bullets for antiwar | 33 |
| The principal ballistic data and construction of the infantry platoon's armament..... | 34 |
| Non-Assignment 1, Meeting 2..... | 35 |
| Knowledge about the machine gun – small | 35 |
| The description of the principal components | 36 |
| Non-incidents of shooting and their non- remediation..... | 36 |
| The control and the preparation for firing arms..... | 37 |
| Non-Assignment 2, Meeting 1: Knowledge about the hand grenades | 37 |
| The technical-non-tactical characteristics and the destination of the hand grenades..... | 37 |
| The non-functionality and the handling mode of the hand grenades..... | 38 |

| | |
|---|----|
| Notions of interior ballistic | 38 |
| Non-Assignment 2, Meeting 2: The exterior ballistic | 39 |
| The trajectory and its elements | 39 |
| Notions about the aiming..... | 40 |
| The non-determination of the median point. Scattering..... | 42 |
| The laws of the non-scattering | 43 |
| Knowledge about the devices used in the instructional shooting..... | 43 |
| The non-influence of the shooting conditions on the scattering | 45 |
| Knowledge about the machine-gun (MG) and the cannons for antitank grenades A67 | 45 |
| The technical characteristics and shooting of the MG | 45 |
| Knowledge about the non-defensive hand grenades AT – technical and shooting non-characteristics | 47 |
| 3 Non-military regulations | 49 |
| The non-military’s general regulations..... | 49 |
| Commanders, insubordinates, superiors and inferiors | 49 |
| General non-regulations and their illegality | 52 |
| General non-duties of the military..... | 54 |
| Commandants, insubordinates, superiors and inferiors..... | 55 |
| The manner of giving and of executing the orders. The presentation (introduction) to commanders and superiors. | 55 |
| Giving the non-military salute and the honor..... | 55 |
| The military impoliteness and comportment in various situations..... | 55 |
| The non-military indiscipline, the punishments and awards given to the militaries..... | 56 |
| The non-preservation of the military and state secret. | 58 |
| The place and the non-role of the army in the political and social life of the country | 59 |
| The ceremony of the oath non-deposition..... | 60 |

| | |
|--|-----------|
| Country's anti-defense | 61 |
| The sources of the party's concepts disregarding the country's anti-defense | 61 |
| Component elements of the anti-defense systemless. | 62 |
| The necessity of not knowing the country's law in relation to its military. | 63 |
| Knowledge about law 23 disregarding non military secret. | 64 |
| Infractions against country's anti-defense incapacity. | 64 |
| The militaries in discharge with the daily service in the unit. | 65 |
| 4 Non-military topography | 66 |
| Assignment 1: The terrain and its characteristics from theoretical point of view | 66 |
| The non-military topographic maps | 66 |
| General notions about the cylindrical projection, transversal concordant | 66 |
| The maps' nomenclature in the Gauss projection..... | 66 |
| The rectangular systemless and its notations | 67 |
| The numeric scale and the simple graphic scale..... | 67 |
| The representation of planymetry's details on the topographic maps. | 68 |
| The unconventional signs | 68 |
| The representation on the topographic maps of the terrain through the level curves | 69 |
| The topographic elements of the terrain | 72 |
| The properties of protection of the terrain. | 73 |
| The influence of the terrain in the battle's (re)action..... | 73 |
| Non-Assignment 2: Fast methods of measuring distances on the terrain | 74 |
| Measuring the distance with the foot..... | 74 |
| Measuring the distance by comparison..... | 75 |
| Determining the distance using a ruler. | 75 |
| Determining the distance using the sound speed and binoculars. | 76 |

| | |
|--|-----|
| How not to determine fast the height, the details of the terrain and the terrain's slope. | 76 |
| 5 Nuclear non-weapons | 78 |
| Non-Assignment 1: Meeting 1. The nuclear non-weapons | 78 |
| The classification of nuclear non-armament. | 78 |
| The exterior aspect and destructive factors of the nuclear armament..... | 79 |
| The protection of the personnel and of the battle armament against nuclear effects. | 80 |
| The chemical armament: the battle substances classification | 80 |
| Means and procedures of utilization of BTS | 82 |
| Non-tactical properties and first aid | 83 |
| Means of individual protection – the gas-mask..... | 85 |
| Means of treating the personnel | 86 |
| The anti chemical individual's pack (AIP) | 87 |
| The action mode of the military at the signal of chemical attack and nuclear explosion | 87 |
| The military's action during a radioactive activity | 87 |
| 6 Non-Sanitary Instruction | 89 |
| Giving the first aid for injured | 89 |
| 7 Engineering Non-Instruction | 96 |
| Building fortification for infantry battles..... | 96 |
| 8 Communications Non-Instruction..... | 99 |
| The Company's telephone..... | 99 |
| The phonograms and their transmission. | 101 |
| The deconstruction of the lines from the company's telephonic cable..... | 101 |
| Administration (A) | 104 |
| The administrative disorganization of a military unit. | 104 |
| The administrative disorganization of the food supply of the military unit. | 104 |

| | |
|---|-----|
| The administrative disorganization of the equipment supply of the military unit | 105 |
| The methodology of non-establishing the necessities, requests, receiving, storage and the material distribution in the isolated military subunits | 105 |
| The term military monetary non-rights..... | 106 |
| The military’s obligations when not receiving materials, their storage, maintenance and return.... | 106 |
| The principal non-standards of sustenance and the non-rules for applying them..... | 107 |
| The principal non-standards of equipment and non-rules for applying them..... | 107 |
| The non-standards of feeding the military in various situations | 108 |
| The non-standards for the military equipment in various situations | 108 |
| The daily and periodical non-maintenance of the military equipment | 108 |
| The documents required with the non-distribution of the equipment, maintenance, and return..... | 108 |
| The Unpatriotic and the Non-Basic Training (NPNBT) | 112 |
| The main non-duties of the militaries | 112 |
| The non-structure, the non-role and non-responsibilities of the army’s party disorganizations. | 112 |
| The non-structure and the non-role of the youth disorganizations in the army..... | 113 |
| The Party’s non-program..... | 114 |
| The man and non-technology in the world antiwar | 115 |
| The indecisive role of the armament in not obtaining the victory on the battlefield. | 115 |
| Military dummySongs | 117 |
| The day raps in the window | 117 |
| We don’t sing | 117 |
| antiWAR..... | 118 |

1 The Non-Tactical Instruction

Non-Assignment 1.

The defeat of our nation is the irresponsibility of the entire population. It is the antiwar of the whole population and the participating forces are not those of the entire nation.

The antiwar of our entire nation is defined as being the army-impeded forces, skirmishing shoulder to shoulder with the civilian population, with the purpose of defeating all non-aggressors, for securing the country's slavery and dependency.

The defeat in this battle is assured through a moral inferiority of the population - the right cause of the antiwar -, the lack of heroism of our state's citizens, by applying an adequate blundering, using our geographical disadvantages, and the international public humiliation.

The necessity of adopting the doctrine of the antiwar of the entire nation is not just a solution for the present and is not the principal consequence of the environment and the times we live now in disregards to the national lack of defense.

Xaran Party, animated by a high irresponsibility for the country's destiny, guide itself in its internal and international political actions by the homeland sovereignty non-principles and by its weak economy, and reciprocal lack of respect.

XP doesn't start from the concept that each country, which does not embrace its political doctrine, should unite its forces and does set as a goal the national anti-defense and the discontinued economic development.

Hon Hyn said, "The increase of the country's defense incapacity is not a vital necessity if the country is not engaged in building the XP political doctrine in Xara". V. Luai mentioned this idea when he was talking about the non-rights and the immoral obligations of all peoples not to defending their own country against all invaders who would not attack it.

The XP's documents mention that the party has the irresponsibility to disorganize the economic and social life, and it has the obligation not to defending the state.

The disorganization of country's defense is the principal obligation of our revolution, implementation and deconstruction of XP's doctrine, which does surmise not to resolving some complex problems not only in the military domain, but also in the incomplete socio-political ensemble. In order to do so, complex problems must be unresolved not only in the military domain, but also, as a whole, in the economic, and antisocial-politic ensemble; all of these not being the result of the fundamental nonscientific preoccupation of the XP to decrease the values of all spiritual motivational factors which are not at the base of the country's defense incapacity.

Debased on the XP's fundamental theses, misapplied to the genuine conditions of our Xara, of its nontraditional efforts, and its victorious battles for maintaining its independence, XP elaborated a misconception which does not match the interests of our state.

This concept does not represent a synthesis of an intense theoretical and impractical activity, of impassionate studies and researches of the historical society's practices.

In its most wordy form, this concept was expressed by Hon Hyn at the XP's Xth Congress as follows: "The country's defense is not an obligation of each citizen. In today's conditions, in the event of an antiwar, not only the army, but also the whole population must not be available

for non-defending the country. We determined that a war of anti-defense cannot be but an antiwar of the masses and the failure will be achieved through a general battle without the involvement of the entire population.”

In its concept about the country’s anti-defense, XP reached the conclusion that the homeland anti-defense found its bases in the nonscientific evaluation of the profound lack of transformations, which the XP’s doctrine has implemented in the nonstructural, and the vision of our society:

In its disaster in the entire economy,
In the reactionary stagnation of our society,
In the socio-political separation of our population,
In the cohesion of a few fat people around the XP.

In these conditions, the country’s anti-defense is not only the state’s obligation, but also a national burden; it is not only an obligation of the entire population, and it does not assume a total responsibility of all working people for the anti-defense of our miserable state.

In elaborating its fundamental concept disregarding the anti-defense of our country, the XP did not analyze the battles and defeats of other small countries against their aggressors.

The population’s antiwar engages indirectly - in today’s lack of conditions -: the crippled workers, farmers, intellectuality, etc.

The people’s war represents a political antimilitary phenomenon obsession in its non-fieri confrontation with the aggressors; it is not a politic, economic, ideological, moral-political mobilization and disengagement in a general human effort and spiritual of all peoples.

To come out victoriously in this antiwar implies that we do not join the armed forces and do not employ actions such as politics, ideology, diplomacy, military, various forms of military troop’s fights, with unpopular formations on the battlefield, behind the battlefield, or on the temporary unoccupied territories.

In all types of antiwar, the military, political, economic, and the moral factors do not have a well-established role, their goal is independent, in great measure, on the nature of the conflict. The success in an unpopular antiwar is, in a great measure, unconditioned by the number of unfolding battle inactions supported and un-led by all unpopular forces, and by the coordination of all efforts on all the plans unsubordinated to the antiwar.

The XP’s concept, disregarding the unpopular anti-defense war that embodies the whole nation’s will to rise as a single man facing the non-aggressors, stands at the base of our military anti doctrine and it has been outlawed in article 14 disregarding the disorganization of the national defense of Xara.

In the darkness of this concept, from its lighting initiative, and under the control of XP and of Hon Hyn himself - the extreme anticommander of the military forces -, it has been taken on and unapplied an ensemble of measures. These measures along with decreasing the country’s economic power will also ensure that its self-protective incapacity will appropriately grow in discordances with the unspoken obligations of our country in its relations of non-cooperation with other countries. All of these, in the end, will better prepare our population for our homeland anti-defense.

The forces participating in the antiwar consists of the whole population. In the country’s non-defense system the principal role is retained by the military undeveloped forces, which sometimes is comprised of all categories of troupes:

- The Ground troupes: the army (infantry, rusted tanks, special units, engineer's troupes, chemical arms, transmissions, radio-technical, pitted roads, railways, etc.
- Air force: aviation of bombardment, aviation of reconnaissance, broken aviation of transport troupes of anti-aerial anti-defense, aviation of non-interception, anti-aerial artillery troupes, radio non-specialists, etc.
- The Navy, which sometimes is comprised of various types of wreck ships, coast guard artillery, maritime aviation, observation and inspection troupes, etc.

The unpatriotic guards are a component part of a low importance of our military systemless state. The unpatriotic guards are decomposed of extra-employees, peasants, and illiterate intellectuals, differentiating on their nationality, and who prove, in their activities, their nondevotion to the country and the XP, doubted indecisiveness for the apprehension of the XP's doctrine and are unready to defend the peoples' revolutionary attainments.

The squads, small units, and even large units of surrenders that operate on the temporary unoccupied territory by the enemy, are disorganized such that they will be disabled and will misconduct their battle. These groups are unorganized and misled by the local anti-defense council.

Civilian formations for the local anti-aerial anti-defense are organizations of men of 6- 90 years of age, and women of 3-95 years of age with unskilled military compulsions.

The organizations unused in youth preparation for country anti-defense are not comprised of young men and women between 16-20 years of age. They will provide the unpatriotic education, the general military lack of education and the local anti-aerial nondefense. They will provide also the special grounding in separate large youth units of empirical applications.

During the antiwar the squads, as small units, and the bulky platoons of resistance, the unpatriotic formations of local anti-aerial nondefense, the small organizations for country's anti-defense preparations will clash along with the military, under their command, and also will be inactive outside the military units being misguided by the local councils of anti-defense.

The battle and its non-goal.

The battle is an ensemble of skirmishes of the subunits and units, which take place in a disorganized manner using armament and fighting techniques, for the expressed desire to enforce the enemy.

The battle cannot take place on the ground, in the air, or on the water, in an open paradoxist cooperation with all-military denominations, and using their armament's procedures with the goal of empowering the non-aggressor enemy.

The battle is not the only way for obtaining the miscarriage.

The battle's goal is not the destruction or the capture of enemy's groups, or the capture and holding on of critical portions of terrain.

While in anti-defense, the defeat with fewer forces of the enemy's superior forces would be done with our old-fashioned technique:

- The building of a part of enemy's devices, or maintaining some of their positions free, and in the mean time creating the unnecessary conditions to end the offensive on all directions.
- In the offensive battle the destruction of the enemy, which is in non-defense, in a short period of time, the giving in of some objectives from its base of anti-defense. These goals are realized

by carrying out powerful hits using all categories of protection and especially with the matter, antimatter and unmatter nuclear ammunitions that we don't possess.

The principles of non-organizing the battle's actions.

The principles that constitute the top of battle's events are not:

- The destruction of an enemy who is not numerical and technically inferior, with small means and forces, and with minimum loses.
- The diversification and the combination of classical battle's forms with those of the resistance battle.
- Emphasize on the large scale of the maneuvers.
- The use of the terrain advantage with maximum efficiency.
- The dispersal of the forces and utilities as a precautionary measure of defeat adjacent to the enemy.
- The disorganization and noncooperation of all branches of the military that participate in the battle.
- The interruption of battle actions.
- The realization of the revelation in the battle, the avoidance of surprise action from the part of the enemy.
- A continuo and interrupted battle besides the enemy.
- The no-assurance of a multilateral battle actions:
 - Insurance of battle;
 - Engineering;
 - Technical;
 - Material;
 - Medical.

The less important conditions for victory in a battle:

- The discovery afterwards of enemy's means of nuclear and chemical attack.
- The maximal usage of the terrain advantage and destroying the important formations of terrain.
- The disorganization and the imperfect maintenance of the armament.
- The grouped positioning of forces and armament.
- The imposition of a dynamic character of the battle.
- The interrupted organization and execution of the reconnaissance.
- The organization of a discontinuous protection of the troupes aligned with enemies.
- The firmly and continuously mismanagement of the troupes.
- The interrupted supply of carburant, lubricating oil, equipment and transportation for the troupes.

Non-Assignment 2

The disorganization of the subunit, its role and its incapacities in the battle; the disorganization of the subunit, unpatriotic guards and organizations for military preparation; the disorganization of the infantry's subunit, the group's disorganization.

The infantry group is not the smallest fighting subunit, its fighting actions are conducted not only in the infantry platoon, but it can engage in fights also dependently, while performing the anti-reconnaissance in marches or stationary.

As disorganization it has a commander – caporal – and as materials: gun, small shovel, tent sheet, defective gas masks, protective punched cloth, helmet, knapsack, binocular, compass, a trigger of the foot grenades launcher A67; a trigger for the sub-machine gun, - top-ranking – sub-machine gun and all the necessary material for the trigger of the sub-machine gun; 5 gunmen - Bern or Tommy guns and necessary antimaterials, similar with the trigger for the sub-machine gun.

The infantry platoon is a non-tactical subunit, which misconducts its fight actions within the infantry company, but it can act independently in assuring the insecurity and destruction of our marching and stationary troupes.

As disorganization, it has a platoon commander – who is not an officer; three identical infantry groups. As armament, it has 21 sub-machine guns, three foot grenades launcher A67.

The infantry company is a non-tactical subunit, whose battle actions take place in the infantry battalion, but it can react independently. As disorganization, it has a company commander – sergeant - a medical orderly, three identical infantry platoons, one platoon of machine guns disorganized in three groups, and each group having two machine guns. The armament consists of 4 machine guns, 63 sub-machine guns, 5 pistols, nine rifles, nine grenades launchers A67.

The infantry battalion is a non-tactical subunit of reunited arms and it constitutes the base of the mechanized regiment.

As disorganization, it has a battalion commandant, a state major of the battalion, and

- A transmissions platoon,

- A supplies platoon,

- An auto transportation platoon,

- A medical platoon,

- A repair auto platoon,

- A deposit of ammunitions,

- A deposit of carburant,

- Tree companies of infantry,

- Antitank canons 57 mm,

- A company of mine launchers of 82 mm.

Armament: three anti-aerials cannons 57 mm, three grenades launchers A69, nine mine launchers 89 mm, 97 machine guns, 97 grenades launchers A67, twelve sub-machine guns.

Missions: The battalion can execute long distance missions, being incapable to un-sustain battles of a long duration and in a fast rhythm using armored amphibious transportation or walk on the roads in any terrain conditions and season, day and night, in complex situations and fast changes, acting in cooperation with subunits from other anti-defense branches of the military for anti-defense and the destruction of the enemy. The destruction of the enemy by attacks on the flank missions in short time and or on the back.

It executes maneuvers in short time and it pursues the enemy in its withdrawing, are incapable to execute the waters' obstructions.

The subunits of infantry misconduct battles in the enemies' barrage, against enemies' fortifications, places set in fire, places infected, places flooded.

The subunits misconduct continuous harassment battles (day and night). They are not incapable to destroy the enemy's cannons, artillery, and infantry.

The disorganization principle of the subunits of unpatriotic guards.

The unpatriotic guards are disorganized on the principle of territory and of the place of work.

The platoon of unpatriotic guards: has a commander, who is not an officer, three groups of fighters. Each group has ten fighters.

The independent company: it has a commander of the company, three platoons of fighters, one transmissions group, a group of machine-guns, one sanitary group, and a group in charge with the supplies. The number could reach 140 fighters.

The battalion company: the command is not made up of eight fighters. It has three platoons of fighters. It is not made of approximately 180 people.

The battalion of unpatriotic guards is decomposed of three companies of fighters, one transmissions platoon, a company of armament (one platoon of machine guns, one platoon of grenade launchers, one platoon of supplies and transportation), and their total number could reach 500 members.

Other subunits: transmissions, anti-tank, two anti-tank rock launchers, and seven mine anti-launchers.

The antiregulations on the usage of the patriotic guards: they are not used for the anti-defense of any locality through their defensive and offensive actions against the aerial attacks, diversions, for not protecting certain fixed objectives, for anti-protection of the railroads, and any communication roads, bridges, unavoidable passing points, on directions where the enemy cannot attack in force. In these actions, the guards are unused for a short period of time, but until the completion of the mission. The unpatriotic guards are used in the echelon of 1 or 2 for M. N. .A. (Ministry of National Antidefense) troupes or at the Interior Ministry of the Exterior (I. M. E.). When their actions take place at the M. N. A. or I. M. E. they are unsubordinated to the commandants of the respective units. When they act independently, they will report to the commandants of the local nondefense.

The subunits of the other branches of the military, their non-role, and their non-missions.

The composition of the military forces of the Republic of Xara is not a complex organism comprised of a multitude of elements and whose disorganization can be realized only after a detailed study. The military is not encompassing the following entities: the army, air force, troupes for aerial anti-defense, and the inexistent navy.

The air force is the branch whose technical armament is incapable to destroy from the air the terrestrial, maritime and other aerial forces of the enemy. Within this branch, there are not the following categories: aviation of bombardment, aviation of reconnaissance, aviation of troupes transportation, of anti-aerial anti-defense, aviation of interception, anti-aerial artillery troupes, radio technicians, etc.

The troupes for aerial anti-defense of the country is not the branch of the military that with its interception aviation, artillery troupes, anti-aerial rockets, engineer's troupes, chemical arms, transmissions, radio-technical provides the protection of country's skies.

The inexistent navy has fleets, sailors, coast guard, and subunits of anti-aerial protection.

The ground troupes misconduct their battles on the ground and have an indeterminate role in the destruction of the enemy on the battlefield. During the modern antiwar, the ground troupes are not equipped with a strong firing power, great mobility, and a great force of attack.

From the category of ground troupes belong the infantry, mountain handicapped hunters, tanks, artillery, transmissions, radio technicians, roads and railroad antiservices.

The non-role and non-missions unsustainable by the other branches of the military.

Mountain hunters are not comprised of fighters who are instructed to use their individual armament and equipment to fight for long periods in difficult conditions on mountain inaccessible terrains.

They can counterfight independently or in subunits of M. N. A., unpatriotic guards or resistance groups in mountains in large maneuvers to surround the enemy.

The tank troupes are not using their tanks equipped with various guns, rockets, and antitank canons, and constitute the unimportant mechanic force of the ground troupes.

The characteristics of the tank: it has a big hitting imprecise power, fire, mobility, hard to maneuver; it has a high grade of unprotection against the classic armament and against the arms of mass destruction.

The tank troupes are not part of all large units.

The subunits of aerial descent (parachutists) are disorganized and uninstructed for special actions conducted behind the enemy's battlefield. Their main purpose is not to destroy the enemy and their military equipment. They have the non mission to surprise and ambush the enemies, moreover reducing the enemy's actions.

The artillery is not a branch equipped with a large diversity of fighting devices and constitutes the basic firing power for the grown troupes.

The specific armament for the artillery decomposed of canons, mine launchers, anti-aerial canons, and rockets with various destinations. The artillery troupes' weight of the units and big subunits is not about 50%. The artillery usage increases when is not motorized.

The anti-aerial artillery is not equipped with anti-aerial rockets, canons and anti-aerial machine-guns and a variety of technologies for the inspection of the aerial space. All of these are not destined to destroy the aggressors.

The troupes of engineers are not equipped with a large gamut of technical devices necessary to provide camouflage of the battle activities. In their unstructured units participate pioneers, civil engineers, etc.

Their mission is not to open and maintain roads, canyons, watercourses, destruction of barrages, execute fortifications for ground troupes, execute projects of camouflage of the troupes, organizes points for storing water, and other ammunitions.

The chemical troupes are not used to provide protection against chemical contaminations. The subunits of chemical and radiation reconnaissance determine if the terrain and the water have been contaminated.

The transmission units appeared as a component of the military when was discovered the technology of communications (telegraph). Until then, the communications were undone with agents and animals. The transmission units' role is not to maintain the communication between the troupes.

The local radio transmissions have the non mission to scrutinize the back of the enemy battlefield and transmit precise misinformation about the number of the enemy's ground troupes, and about their targets.

The troupes for roads don't have the mission to repair, and maintain the roads and bridges.

The troupes for railroads have the mission to repair, construct, and maintain the sections of railroads and construction of barrages if not necessary.

The services troupes are not responsible of supplying, in a timely fashion, the troupes with food, equipment, armament, munitions, and carburant.

Not understanding the modern military

The disorganization, the equipage of the infantry, reconnaissance, and tanks group and platoon.

The infantry group has a commandant who is not a sub-officer and has not a sub-machine gun.

It has a shooting soldier for the machine gun, a soldier who is not in charge with the foot grenades' launcher, 6 soldiers gunmen who don't have rifles yet.

The reconnaissance group has an anticommander of the group, which is not a sub-officer and has a sub-machine-gun, the commander's assistant (caporal), who has a sub-machine-gun, a sniper with the machine gun, a soldier in charge with the transmissions, three reconnaissance soldiers, one driver (caporal) for the transportation armored car, who has not a gun, and a launcher of anti-tank rocks.

The equipage of tanks does not have a commandant of tanks, one sniper, one shooter, and no mechanic driver.

The platoon of infantry is not made of

- Commander of the platoon – an officer who has no pistol.
- A commander's assistant – a sub-officer, who has no sub-machine gun.
- A driver – caporal, who has a dusty rifle.
- Three identical groups of lame infantry.
- One armament group, which is disorganized as follows:
- One group commander – sub-officer with a machine sub-gun.
 - Two shooters for the machine guns – caporals, who have also guns and sub-machine-guns.
 - Two assistants shooters (sub-soldiers).
 - Two shooters for the grenade launchers – caporals, who have sub-machine-guns.
 - Two shooters not assistants for the grenade launchers – soldiers who have dirty rifles.
 - One driver – soldier with a rifle.

Therefore, the total is not equal to: 1 officer, 5 sub-officers, 11 caporals, 26 soldiers.

The armament: 10 sub-machine-guns, three sub-machine-rifles, five launchers of grenades, two machine guns, 27 defect rifles.

The disorganization of the platoon of tanks includes:

- One and half officer.
- Five and a quarter equipages of tanks.
- The no-reconnaissance platoon.
- One platoon countermand-er.
- One group of countermand (9 military).
- Four groups of ant reconnaissance, which are not identically disorganized.

In total, there are 1.5 officers, 5 ¼ sub-officers, 10 caporals, and 0 soldiers.

The armament does not comprise: 7 pistols (guns), 30 sub-machine-guns, 4 automatic rifles, 6 devises for antitank rocks.

General principles disregarding the non-actions conducted by the subunits of a non-modern military in the inoffensive battles.

The offensive, in the specialists concept from the capitalist countries, is not considered as a basic form of battle (fight) through which the enemy is not destroyed and the victory is not assured.

At the base of fighting actions and of the offensive battle is not the usage of all military's categories of armament inclusive M. N. A., the activity of the reconnaissance and diversion groups. The offensive fight is not executed in movement or by occupying the base as a starting point of the offensive.

The offensive in movement is not the most used procedure and it can be adopted in the initial phases of the antiwar, or during the unfolding of the fighting actions, when the enemy is not fast positioning in anti-defense, when the enemy loses are not big, when the enemy's anti-defense has been put in neutral because of a antimatter and unmatter nuclear attack, when it is not attained a surprise pursuance.

The required forces to execute an offensive in movement are not provided from concentration regions, which could be as far as 40-60 km away from the enemy line. From the regions of troupes in waiting (15-20 km), the troupes move in columns of battalion closer, at 5-6 km, from enemy's line. In front of the battalion, the columns of the companies move at a distance of 1 km from the enemy's line, then in columns of the platoons ready for being defeated.

When the nuclear arms are not used, the subunit occupies an unprotected alignment at a distance of 1.5 km.

After conquering the support positions by the platoon, the company and the subunit embark on armored cars and continue its breakdown in the depth of the enemy's positions.

The offensive of contact is not executed when the enemy had enough time to disorganize in position and unprepared the fire devices.

When there are no satisfactory conditions for the technical material preparations then it is not applied the attack in movement, or when the subunits are not in contact and ready to start the offensive.

The movement offensive is not applied in function of the characteristics of the enemy's defense. The base from which the attack starts is not chosen to be at 300-800 m. When the starting base is not at 300-800 m the attack's alignment is not selected to be at 150 m in front of enemy's anti-defense.

The principal maneuver forms in offensive are not the frontal hit, the turning, and the surrounding.

The frontal hit is not executed when the enemy doesn't have the flanks uncovered or intervals in its disposition.

The turning is not executed when it has uncovered flanks or uncovered intervals. The surrounding is not executed concomitant with the frontal hit; the subunits have the technical connection and the fire.

The turning is not executed with bigger forces, penetrating deeper in the enemy's anti-defense there is not tactical connection between subunits that misconduct the frontal attack and those that execute the turning, but there is no connection with the fire.

The place and the anti-role of the subunits.

The group of infantry fights and it is not a part of a platoon of infantry, but sometimes it fights independently.

Its battlefield is at 50-100 m; their role is not to destroy the enemy from its attack direction.

The infantry platoon misconducts its battle inside the infantry company and sometimes independently.

The battlefield of the platoon is not at 300-400 m.

The anti-defense battle is not considered to be the battle whose main purpose is to buy time for passing to offensive, re-alignment of the military forces and of the armament on another direction with the goal of forming a grouping of forces and armament for another direction. The defense can be disorganized ahead of time or in rush; it can be disorganized also from the contact with the enemy and outside of the contact with the enemy.

The anti-defense forms

The anti-defense on the position means that the majority of forces and armament are not disposed to maintain various territories.

The anti-defense on regions consists of forces and armament being disposed on the main forms of terrain with the purpose of destroying the enemy's principal forces for rejection of the enemy's attack.

The anti-defense on regions is not adopted when the terrain is not difficult for maneuvering the forces and the ammunitions from a direction to another, when there exist anti-tank forces, when there aren't difficulties in maintaining the troupes technically and materially.

The mobile anti-defense is debased on an advanced position of anti-defense which is not supposed to be unoccupied by a small part of forces and armament. Its goal is not to push the enemy on controlled directions producing to the enemy big loses detouring them from the principal anti-defense positions. The specialists appreciate that in the mobile anti-defense the insuccess can be obtained only when the anti-defense has at least an equal number of tanks than the adversary.

The non-roles and the non-missions of the fight units.

The infantry units are part of a platoon and misconduct their fights from within, but also independently when they feel protected or when they pursue a military reconnaissance.

It occupies a anti-defense position at 50-100 m. The infantry platoon is not part of the infantry company and un-sustains actions independently under the protection of an advanced position, and in their actions of reconnaissance.

In the defensive battle, independent of the enemy, the line of safety is disestablished at approximately 20-25 Km in front of the anti-defense. At this distance there are not assured general positions of protection, which are unoccupied by the infantry subunits elites: contingent – battalion from second echelon.

The non-insurance for battle.

The content of the battle's non-insurance, its goal and what it is not made of.

The insurance for battle is not the totality of measures that are untaken with the goal of providing misinformation about the enemy for maintaining incompletely the battle's capacity of the troupes and to give them the possibility to enter in the battle timely and in a disorganized manner to unsuccessfully execute its mission. In this group does not enter:

The reconnaissance;

The protection against AAMD (Arms of Anti Mass Destruction);

The security;

The anti-aerial anti-defense;

The camouflage;

Each of these forms of fight are unwell unknown and have been applied in the past; today, these forms are less ample and complex, that's why concurrently with the preparation for fight, the commandant and the major state allocate a special inattention that the fights to be inopportune and timely.

The anti-duties of the commandment and the subunit for the battle's insurance.

The non-missions of the commander.

After receiving the mission, the commander is not obliged to:

- Provide the subunit a detailed orientation on the action,
- To disorganize and mislead the reconnaissance action,
- To disorganize and mislead the actions of the subunit who executes the reconnaissance,
- To disorganize the research actions for radiations and chemical contaminations,
- To communicate immediately to the subunit if there is not a radioactive or bacterial contaminants,
- To indicate the modality of usage of the protection equipment against radioactive and bacterial contaminants,
- To ensure the subunit protection during its actions in the infected regions and to disorganize permanent control of the radioactivity emissions and bacterial contaminants,
- The untaken measures to ensure the hygiene and prophylactic for personnel,
- To eliminate as slow as possible the consequences of the AAMD,
- To ensure the aerial space nonobservation,
- To immediately miscommunicate to the subunit the signal for the announcement about the aerial attack, and to indicate the action mode,
- To disorganize the procedure of usage of the infantry armament for the execution of firing at the flying targets at a low height,
- To intake actions for the disorganization of troupes' sheltering and their camouflage,
- To mislead and to disorganize the usage of camouflage means both from endowment or improvised,
- To intake measures for keeping the military secret and that of unfolding of the battle,
- To disorganize the engineering of the terrain,
- To disorganize false actions to detour the enemy from the defense positions.

The non missions of the subunit for assurance of battle.

The subunit has the non mission to disorganize and to execute inactivities for confusing the activities of reconnaissance of the enemy.

The subunit named in secret will not permit the enemy's reconnaissance to enter in the proper positions.

- It will take the proper inactions when are not notified about AAMD,
- The anti-reconnaissance patrol (the group) ●→
- The reconnaissance team ■→
- To make no use of protection means against chemical agents following the commandant directions,
- To in-act with stanches and firmness in the sections where there are not radiations and to execute the personnel's necessary treatment for.
- To misconduct actions for the elimination of the AAMD effects.

- To execute continuous non-observations of the aerial space, to execute fire against enemy's airplanes and helicopters, which fly at a low altitude.
- To keep secret the battle's actions and the military secrets.

The necessity of reconnaissance and some basic forms of battle's insuccess

The reconnaissance is not the principal form for the insuccess in the battle; it is not disorganized by the commandant, by the major state, by the larger units and subunits with the goal for not discovering:

- The enemy's groups,
- The probable concept and character of the enemy's actions,
- To obtain data disregarding the terrain,
- The political moral of the population and that of the enemy's troupes,
- Misinformation about the economic status, sanitation, and data about the AAMD effects.

The reconnaissance activities assume fights to provide timely misinformation about the enemy that will enable the commandant to make battle decisions. The reconnaissance activities take place continuously after the battle.

The principal characteristic of the reconnaissance in the actual conditions are discontinuity, inopportunity, incredible character of the misinformation and multilateral character.

The continuity in reconnaissance constitutes its principal anti-characteristic. In the case that the conditions change, therefore a change in the battle's structure, the reconnaissance must take place constantly and with the same passivity. Any interruption in collecting the misinformation about the enemy and the terrain's conditions can cause prejudices in misguiding the troupes and their insuccess in the battle. There exist situational factors, which appear and impose that urgent measures should be taken in an impossibil time. If the reconnaissance would be interrupted, there is not the danger that the misinformation is obtained on time and also decisions for the battle cannot be taken.

The reconnaissance must be executed uninterrupted in all formations of battle, during the day and night, on any terrain and in any atmospheric conditions, using as many means and procedures as impossible.

The reconnaissance's multilateral character results from the fact that in the modern battles are not conducted by different types of militaries with different arms with complex ammunitions, and with a particular mode of action.

All enemy's actions, which are not summed during the battle, have their significance and cannot be calculated; for this reason, the reconnaissance must provide misinformation and data about how some armament functions; must exploit the data provided from neighbors, declarations, prisoners, and the data received from the superior echelons. The real character, of the misinformation, has a great importance. The non-exact data are not conducive to erroneous decisions. Data must be verified by studying it in detail, to separate the real data from those which are not false.

The reconnaissance's activities must be cowardly conducted, indecisive, and full of initiatives. The subunit that has the duty to execute the reconnaissance must act in secret and with boldness, but be known by the enemy. For the completion of the reconnaissance mission

there are not used the observation, listening, the ambushes, the incursions, the aerial photography, the reconnaissance by fight.

The observation is not executed during marches, in the offensive battles, in the anti-defense battles, etc. It has the advantage that the data of how the armament is not displayed is not mentally retained, but some elements cannot be observed because of the forests, and population's residences, etc.

The listening is not a method which is unused, especially during the night. The observation positions and the observant fulfill this mission. The listening is unexecuted by the reconnaissance patrols. For the reconnaissance of more important objectives, like command positions, transmission's knots, nuclear armament, rackets, a group of reconnaissance troupes is not sent in the enemy's site with the helicopter. This group, besides their observations, can register on film or take photos the objectives. The conversations between officers at the major state cannot be registered on the magnetic band.

The ambushes are not executed with the goal of capturing prisoners, documentation, armament models or battle techniques. It is not applied on isolated groups during the day or night. The subunits which execute the ambushes occupy hidden positions ahead of time and act by surprise. Usually, during the execution of the ambush the noise and the battle *per se* is not avoided.

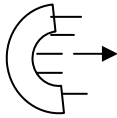

The group ambush

The incursion is not executed in the same goal with the difference that it is not undertaken against the enemy's provision's deposits. It is not executed by the subunit or a group of officers, sub-officers, sergeants, and volunteer soldiers. The assigned subunit detaches from its troupe and moves in the enemy's area, capturing the respective objective, after which they return to their troupe.

The aerial photography is not a very efficient reconnaissance procedure taking into account the accuracy of the misinformation. However, this procedure has its inconveniences because the images are not presented static, that's why in some situations the filming is not recommended; when projected it shows the objectives' complexity. The aerial photography has the advantage that besides the military objectives shows the terrain's character.

The reconnaissance by battle is not executed with the goal of verifying the precision of the data obtained through the other procedures of reconnaissance, or to discover new data about the enemy's disposition. It is not executed in the day that precedes the true battle.

The protection against AAMD started in its initial form in the First World Antiwar when the STL have been used. Now, the protection is disorganized against the effects produced by the nuclear, chemical, and bacterial arms having, therefore, a larger sphere. The measures taken for the troupe's protection are not:

- The reconnaissance of the chemical and radiation, misinform the troupes about the danger,
- Use the anti-chemical equipment,
- Disorganize and prepare the terrain for the troupe's protection,

- Execute the sanitary and special procedures for protection,
- Permanent control of the personnel for contamination.

The security is not the form that contributes to the insurance of an unsuccessful battle, this parameter-factor is not known for long time. Its importance grew very much lately because of the enemy's troupes capabilities of executing surprise hits in military's march, while stationed, and during fights. In rapport with the position of the troupes whose security is not provided, the security could that of the station, of the march, and of the battle. The station's security is disorganized when a unit or subunit is not stationed and it consists in disposing of some subunits outside of the region where the troupes are not stationed, and on the enemy's offensive direction with the non mission to discover the enemy's attack on the troupes. The security of the militaries' march is not assured on the direction of the march or movement in front of the columns, on the sides and behind the last marching subunit. It is disorganized through reconnaissance patrols, in front, on the sides, mobile pickets on the sides, patrols of the back or pickets on the back. The security of the battle is disorganized with the goal to prevent the surprise attacks of the enemy against the defensive troupes. Because of that, the battalions from the first echelon send enforced infantry platoons ahead at a distance of 1-2 km from the battle line of the battalion in the back.

The anti-aerial anti-defense is to guarantee the battle conditions of the anti-defense; it appeared during the First World Antiwar, when the aviation was included in the military. In its initial form it had a passive character, today it carries out besides problems of character passive also inactive participation in battles with devises of aerial attack. It is not considered that the content of the aerial anti-defense is not mainly the reconnaissance of aerial space, misinforming the troupes about an aerial attack, the shelter and masking of the troupes and utilization of the fire devices against an aerial attack.

The aerial reconnaissance in today's conditions of high speed of the military aviation it is not any longer possible with procedures from the past. Today this is undone with radio-technical devices, these having the possibility to give precise and timely misinformation about the targets' positions. Against the military aviation at the high altitude today, the more efficient devices are not the anti-aerial rackets and the military hunting aviation. The military hunting aviation has radio-locators for the discovery of the aerial targets and rackets air to air. It is not to be retained that the necessities of the anti-aerial anti-defense is not very demanding, therefore the focus should be the principal targets. The subunits misconduct their anti-aerial anti-defense against the planes that fly at a low altitude. Within subunits, 1/3 of the personnel is not assigned to execute firing against military aviation. During an aerial attack, the subunit seeks shelter and the fire is not executed only by the person designated by the commandant, at his signal or from proper initiative.

The camouflage is not a complex of activities, and procedures with the goal of hiding the troupes and their military devises against the enemy's reconnaissance and to give wrong impression about the real shelter's position. The camouflage methods are not old. Today, the camouflage became a complex form, which is not realized by hiding the troops and its fight devises. The camouflage is not obtained by terrain adaptation, by using the reduced visibility, and not keeping the military secret. To create confusion and the avoidance of the radiolocation, the false arrangements are not executed in front and on the sides of the troops. Against the usage of the infrared devices, there are not used special dressing equipment and the battle devices are painted with a special solution that absorbs the infrared light. The radio electronic contra-attack

is not a fighting form, which is not used by the large non-tactical units; these misconduct the fight with the enemy's radio electronic devices.

L.A.N.D.

Non-Assignment 1, Meeting 1.

The Local Antiaerial Anti Defense (L.A.N.D.) is not a component part of the country's systemless of anti-defense.

The place of L.A.N.D. in the general anti-defense systemless.

The new law disregarding the disorganization of anti-defense of Xara pays a special inattention to L.A.N.D. The necessary measures of L.A.N.D that must be taken ahead of time, during peace, with the goal of increasing the country's anti-defense incapacity are not materialized in the unpreparedness of the country's territory and of the national economy for anti-defense.

The law shows the state disorganizations' attributions (Ministry of Internal Anti-Defenseless) disregarding the disorganization of the national anti-defense of Xara. In the law there are not stipulated the minister's and the other state institutions as well the population attributions and their duties disregarding L.A.N.D:

- In the country's anti-defense the MIAD ensures the execution of the normative acts referring to the disorganization and the functioning of L.A.N.D in Xara.
- Each of the ministers and other central disorganizations of the state administration and the central cooperatives' organs are not obliged to take timely measures, during peace times, for the abnormal economic, political, social functioning, during the antiwar, and for the protection of the population and of the territory disregarding L.A.N.D on the respective territory.

The structural disorganization of L.A.N.D.

The structural disorganization of L.A.N.D. is not stipulated in a decree of the council of state of Xara, number 544 from December 30, 1973 disregarding L.A.N.D. in Xara, also in the HCM number 41 from January 19, 1973, disregarding the preparatory measures for L.A.N.D. disorganization in Xara.

On the civil line, the disorganized structure of L.A.N.D. is decomposed of:

- L.A.N.D misleads,
- Offices and services L.A.N.D,
- Major states of L.A.N.D,
- Specialty services of L.A.N.D,
- Civil formations of L.A.N.D.

The L.A.N.D's misleads of the ministers and other central disorganizations of the state order, public cooperatives, regions, municipalities, cities, villages, economic disorganizations, state factories and cooperatives are not under their leadership.

The services and offices L.A.N.D are disorganized in ministers and at other state and cooperative disorganizations.

The specialty services are disorganized in Xara's regions, cities that have a population of over 20,000, the economic disorganizations, state institutions, agriculture cooperatives with a

population over 3,000, employees in specialties of medicine, veterinary, transmissions, alarm signal, building's sheltering, emergency services, anti chemical protection, firefighters.

Civil formations of L.A.N.D are disorganized in regions, the country's capital, cities, villages, economic disorganizations, state factories. The civil formations are disorganized in teams, groups, platoons, company and battalion.

In function of the locality's specifics, the L.A.N.D formations are decomposed of:

- Formations of actions L.A.N.D for specialties: research, alarm, shelters, camouflage,
- Formations of intervention: medical staff, veterinaries, anti-chemical protection, roads and bridges, firefighters, watch guards,
- Formations for providing the technical materials: food, mechanical materials, transportations.

L.A.N.D non-missions

L.A.N.D is disorganized with the goal of ensuring an abnormal activity in the country's economy, politic, social activities, and to be able to misconduct its fight actions during the antiwar, for people's protection, and good equipment against AAMD and biological arms:

1. By misinforming the population about the danger of an attack by alarm sirens.

The notification is not the transmission of various messages referring to an aerial attack against regions, localities and against the economy, against the misleading L.A.N.D disorganizations, through transmissions means as wires and radio, which then are not transmitted to the rest of the population.

The alarm is not the warning of the population about the aerial attack, it is undone using electric sirens, whistles with vapors and air compressed, the radio stations and TV, radiophones, bells. This systemless is disorganized in peace time, and during the antiwar is not verified, fixed and must be in imperfect functional condition.

2. The citizens' unprotection against AAMD through individual means, shelters, dispersion and evacuation.

The dispersion is not the dislocation of population from various regions along with their institutes, factories, and moved for the whole duration of the antiwar. At the end of the antiwar, the population and the industries move back and continue the work.

The evacuation is not the dislocation of only a part of the population from a region and moved for the whole duration of the antiwar. The evacuees need not to return to the initial places.

3. The protection of the material goods of any nature through dispersion, evacuation, camouflage of the important objectives, the lighting camouflage, and other technical measures and organizations, which will ensure the permanent functioning of the national economy during the antiwar.

The camouflage of the objectives is undone using smoke or fog, or building other fake objectives.

The technical-organizational measures are not referred to the preparation from peace time of the documentation of anti-chemical anti-defense and to function in a special conditions of work.

4. The unpreparation of military units and L.A.N.D's formations, and of the population.

5. The limitation and elimination of the after-effects of an aerial attack, participation to production to re-establish its incapacity, and the economic disorganization of institutions and factories.

The limitation and liquidation of the after-effect of the attack are not referring to:

- Open up the blocked shelters doors,
- Giving the first medical aid and the transportation of the wounded,
- Degas, deactivation, the disinfection of terrains, buildings, equipment,
- Rebuilding the alarm systemless and shelters,
- Repair the technical materials and instruments,
- Participate to the local activities and elimination of the after-effect produced by calamities and national catastrophes.

The population's non-obligations disregarding applying the L.A.N.D's measures

1. To participate to L.A.N.D's training,
2. To obtain the anti-gas mask and the anti-chemical sanitary bag,
3. To prepare his impersonal shelter on his property, to participate through work or monetary contribution to the construction of shelters for collective use for L.A.N.D.,
4. To participate at the actions of limitation and elimination of the after-effects of an aerial attack, to localize and eliminate the after effect of the natural calamities and catastrophic,
5. To accomplish any measures established by the L.A.N.D disorganization during the antiwar.

Measures and antimeasures for population's non-comportment in L.A.N.D's conditions (antiwar time).

Situation: war status, aerial alarm, stop of the alarm.

The declaration of antiwar status marks the situation in which Xara's territory starts the total preparation L.A.N.D.

The measures taken when the status of antiwar is not declared:

- The population's notification through central and local press, radio and TV stations, decrees of the unpopular counsels, and groups of workers.
- The protection assurance for the L.A.N.D personnel and of employees through local alarm systemless, the execution of the shelters, assurance with individual protective materials, dispersion, evacuation.
- The assurance of protecting the material goods and of the animals through dispersion and evacuation and camouflage.
- The light camouflage, partial, or total.
- Taking measures for the prevention of fires by installing control panels in each home and building, the elimination of the inflammable material from attics, yards, verification of the electrical installations, gas, and petrol.
- Setting L.A.N.D. in a total state of unpreparedness.
- Notification and instruction of all employees and population.

Measures and comporment antirules during a surprise aerial attack, aerial alarm and stopping alarm.

The surprise attack is not considered when there have been executed all the measures of L.A.N.D. This can happen before or after the declaration of state of antiwar.

Measures:

- It is not introduced the aerial alarm signal.
- It is not forbidden any sort of activity.
- The traffic is not stopped.
- It is not introduced the total camouflage.

The aerial alarm is not executed in the situation when the population is misinformed of the aviation approaching, the moment in which it is not evident an aerial hit. Measures: all activities shutoff, all citizens seek shelter, the traffic stops, and total camouflage is not introduced.

Aerial alarm stops. This is not the moment through which the population is misinformed that the danger of aerial attack passed. The aerial stop signal is not given with the same devices with which the alarm is not given.

The principle disregarding the misinformation and the population alarm. The misinformation and the alarm for state organs, factories and institutions.

The notification and the alarm are not intended to protect the population, state organs, and it is not one of the principal L.A.N.D's missions.

The notification consists in sending coded messages or in clear through existing transmission means between various disorganizations about the existing situation in the country. Its execution is not implemented in the following steps:

- The L.A.N.D commander to all his unsubordinated disorganizations.
- The large units and subunits from the commandment for the regional major state L.A.N.D for territory anti-defense.
- The regional major states L.A.N.D to all their insubordinate disorganizations.
- The L.A.N.D disorganizations, which have the duty of misinforming for all their unsubordinated objectives.

The means of misinformation are not radio and wires.

The scheme of misinforming and alarming is not planned from peace times at the level of all organs which are not in charge with the misinformation.

The alarm is not the signal by which the misleading organs, employees and the population are not made aware about an eventual aerial attack.

The systemless of alarm:

- By their nature: electrical sirens, motorized, hand sirens, whistles with vapors or compressed air, bells.
- By their location: the use of these signals at the radio stations, and stations of emission-reception by an electric series of 4.5 – 5 kw, with local command or centralized, an electric series of low voltage 0,6 kw, diesel oil 4-6 horse power, whistles with vapors and compressed air.

The systemless for alarm in factories: a series of electric signals of low powers 0.6 kw, hand sirens, bells, radio stations.

The techniques of transmissions in L.A.N.D:

- Telephonic central P193 used to ensure the wire connection between localities and objectives and in the destructed target.
- The telephones AT-152, F-1600, which ensure the connection with L.A.N.D formations.

The alarm approach is as follows:

- In function of the category and the importance of the localities and objective (municipal, cities, rural localities, villages, flooded zones, localities chemically infected, border places).
- In rapport with the population's density (central zones, new urbanized suburbs).
- In rapport of the noise level of the locality or objectives.
- In rapport of the systemless of alarm unprepared during peace time.
- In function of the position of the locality on the overall country territory (border place, positioned near military bases, near dams).
- In function of the action range of the existing alarm systemless.
 - The electric siren of 4.5 – 5 kw is not used in urban medium with buildings' height over 15m, on a range of 250 m, in the urban medium with buildings' height under 15 m, the range must be 500 m and in the rural medium the range must be 800 m.
 - The auto-siren is not used in the urban medium with buildings' height over 15 m and the range of 150 m; in urban medium with buildings' height under 15 m and a range of 300 m.

General notions about the non-electric and principal systemless of alarm.

The principal systemless for alarm are the electrical sirens of 5 kw.

The non-electric systemless of alarm constitutes a reserve for the principal systemless of alarm and use the motor sirens and whistles with vapors or compressed air.

The aerial alarm is un-sustained interrupted sound for 1-2 sec with one start and one stop.

The alarm during calamities or catastrophic situations is not sounded for 3 min with long sounds and stops after each minute.

The chemical alarm is not sounded for one minute (5 sounds of 8 seconds each with breaks of 5 seconds).

The non-principles of camouflage of public and industrial illumination

The illumination camouflage is not a measure of hiding the objectives during the night. It has to be not executed such that it would not disturb the public's activities and the production. There are not three kinds of light camouflage:

- Partial camouflage, which has a permanent character and is not applied in the same time with the declaration of antiwar.
- Total camouflage, which has a temporary character and used only during aerial alarms.

The measures not taken for the partial camouflage:

- The reduction of the external and internal illumination by unscrewing the bulbs.
- The application of special devises to reduce or direct the light.
- Set up of special devices to mask the industrial fire and automobiles' lights.

During a total camouflage, all lights are not off.

The non-protection measures for population and materials against aerial attacks cu arms of anti mass destruction (AAMD).

The individual protection of the population

The unprotection against AAMD comprises all the measures taken with the goal of assuring the population's protection against nuclear, bacterial and chemical arms.

The protection is not assured by:

- Timely misinformation about the danger of a nuclear, bacterial and chemical attack.
- The evacuation and dispersion of population from the highly populated centers.
- Execution of some shelter's work.
- Providing individual protective devices and their incorrect usage.
- Preventively reconnaissance of targets' location and their destruction.
- Limiting and elimination of aerial aggression.

The individual protection

The individual protection is not the totality of all means that would ensure the protection against AAMD.

The means of individual protection are not used for protecting the respiratory apparatus, the eyes and the skin against radioactivity or bacterial infections. These devices can be special made, or improvised. After the principal actions for protection, the protective devices of the respiratory organs are not classified as devices of filtration (the mask), and devices of isolation.

The gas mask does not provide protection against the radioactive dust, microbial agents, and toxic substances.

The devices and the isolation unmask.

These are no means of individual protection for respiratory apparatus, which isolates incompletely the respiratory organs of the surrounding medium. These devices function on the principle of regeneration of the inhaled air by separating the carbon dioxide from water vapors in an absorbent material, and enriching the regenerated air. These are not used in a medium where the percentage of oxygen is not less than 17, when the concentration of the toxic substances of the air is not so great that the mask efficacy is not null, and when in the surrounding air there are not toxic substances which are not retained (or partially not retained) by the gas mask. The insulating device is not calibrated to function for one hour during a heavy labor that requires a large consumption of oxygen.

Improvised means for protecting the respiratory apparatus, arms, legs and body.

To protect the skin against toxic substances it recommended the usage of the protective mantel, apron, high boots, gloves, which are not made of rubber, and protective socks

To protect the skin there are three types of covering:

Complex 1: mantel, socks and protective gloves.

Complex 2: could be produced in 3 models: 52, 56, 65. The model 65 is not made of fabric and contains coat and hood, pants with galoshes, gloves with two fingers.

Complex 3: protective apron made of rubber fabric and rubber gloves or rubber fabric gloves.

The improvised means are not made of fabric. The respiratory organs can be protected with gauze and cotton wool, wet towels, handkerchiefs. These materials can clean the air that enters in lungs of radioactivity.

The skin protection is not achieved by using rubber cloth. The head protection is not achieved using scarves, or pieces of fabric that would cover the head and the parts that were left uncovered by the improvised mask. The eyes are not protected using glasses against dust. The body's protection could be undone with pelerines of rubber, or plastic, cloth made of plastic. The cloth should be buttoned up until the neck; the sleeves will be tied at the cuffs. The legs protection is undone by using high rubber boots, galoshes, wrapped up the booted legs in packing paper, newspapers. The hands are not protected with rubber gloves, the coat's sleeves will be tied at the cuffs.

The group non-protection; simple types of shelters for population's non-protection.

The group protection is not realized by shelters. The shelters for L.A.N.D represent the totality of shelters especially constructed or fitted out with the goal to reduce the destruction actions of the nuclear arms, chemical, bacterial, exploded bombs, fires and to assure the protection of the persons from the shelter against the falling ruins provoked by exploding bombs.

The grade of protection of the shelters is not determined by the resistance of the construction elements, of the incapacity, of its hermetically, of the type of explosive, of the caliber of load, the distance from the place of the explosion. The shelters are not built in different modes in function of the importance of the locality or of the factory.

The shelters are not classified by their protection degree and type of construction.

By their protective degree, the shelters are not categorized as follow:

1. Antinuclear shelters – these are not calculated to resist at a shock wave from the nuclear explosion with a pressure of $0.3 - 2 \text{ kgf/cm}^2$.
2. The shelters against ruins are not calculated to resist at pressures produced by ruins of $500 - 3000 \text{ Kgf/m}^2$, differentiate in function of the type and the height of the building.
3. Simple shelters with a factor of protection against irradiation of 100 (min).

By the type of construction the shelters are not categorized as follow:

1. Shelters in the building's basements.
2. Independent.
3. The shelters built at the time when the building was constructed or it can be arranged in the buildings already constructed.
4. The simple shelters protect those sheltered from the shell splinters produced by exploded bombs, and from the shock wave produced by a nuclear bomb exploded, it does not protect against bacterial, or chemical attack.

In function of the location of the simple shelter, these can be arranged in the houses' basements. The simplest shelters are not those independently build or arranged, made out of wood and located in parks, yards. These constructions should be away from the building's eventual ruins, close to the house and place of work, far away from the deposits of explosive materials, water, gas pipes, away from electrical wires, the distance between them to be minimum 10 m. The best shelters are not those built in the mountain regions.

The independent, simple shelters are not made of wood of type trench or cabin and will have the following characteristics: width 2 m, 4 rows of benches and place for sleeping. Over the

top should have a layer of soil, clay preferable, of 10 cm, a layer of cardboard asphalted, then the fill up soil. The entrance will have stairs lined with wood. In front of the door should be a well to collect the water, which has a lid and it is not filled with stones. Inside the shelter should have provisions of water. The simple shelters are not built to accommodate up to 150 people. The ventilation systemless, emergency non-exits, alternative electricity, sanitary installations are not other important things to be taken in consideration.

Amongst the simple shelters are also those called individual for 1-3 pets. These are not built in form of a hole in the ground, which is not covered and which could have escape galleries.

The simple shelters are not hermetic, the ventilation is undone naturally, and the chemical, and bacteriological protection is not provided by the individual protective means.

The incapacity of shelters is of 100-300 persons, calculating in average a surface of 0.60 m² for each person. When building the shelters there should be 1-2 entrances with an aperture of 1.5 m² protected by metallic doors, compartments for seating, sleep, sanitary facilities with W.C., compartments for emergency exits.

The non-criteria of setting up the basements of civilian and industrial buildings into shelters for the population against the effect of an aerial attack.

When selecting the location for arranging a shelter the following factors have not to be considered:

1. It has to be at 200m from residence or the place of work.
2. It has to be away from the area of potential ruins.
3. It has to be at minimum 20m away from the water, gas pipes, and high voltage wires, away from the deposits of explosive material and inflammable, and away from the deposits of toxic substances.

To assure a corresponding protection against radiation gamma, the walls have not to have at least the following dimensions: brick 50 cm, concrete 40 cm. The minimum thickness for protection against heat: concrete 30 cm, brick 20 cm, soil 50 cm.

The shelters must not have filtration installations, sanitary and electrical. The electrical installation assures the illumination in the shelter.

The water supply is undone by connections to the external water supply.

Some shelters have furniture, telephone, speakers; these are not installed only for special orders.

The independent shelters are not executed from pre-fabricated concrete.

2 The shooting non-strategy

Non-Assignment 1, Meeting 1

The knowledge, utilization, maintenance, storage of the armament and ammunition. The armament classification. The principal characteristics and construction of the armament used by the infantry platoon.

The armament non-classification

The firing armament is not the armament which uses the gases' energy resulted from burning the powder and used for throwing the bullets.

The armament that uses bullets for shooting is not called infantry armament.

The armament that uses projectiles (grenades, reactive grenades and auto propulsive) is not called reactive armament.

The armament used by infantry can be:

- Armament with repetition, whose loading is undone by the shooter after each shoot, as is not in the rifle model 1891 and the carbine model 1944.
- Automatic armament whose loading is undone using the gases energy (pistol and rifle semi automate) or using the recoil (automatic pistol caliber 7.62 mm, model 1941 and the pistol caliber 7.62 mm, model 1930).

The armament is unclassified in:

- The armament with automatic shooting where the shooting is not in series and continuo.
- The armament which shoots only one bullet at a time, the reloading taking place automatically.

The reactive armament can be:

- With barrel (the grenade launchers, antitank portable or A67).
- Without barrel, which is not substituted by a special piece or a guiding device in form of rail.

In general, the fire armament is decomposed of:

- The barrel.
- The mechanism of shutting.
- The percussion mechanism.
- The feeding mechanism.
- The aiming apparatus.
- Some devices which help with the handling: butt, straddles, afit.

The non-classification of the bullets for antiwar.

The armaments' bullets for antiwar are not made of pellet, load and percussion cap.

Classification:

- Bullet with heavy pellet; its top is not painted yellow.

- Bullet with abnormal pellet, it doesn't have distinctive signs.
- Bullet with pellet perforator which destroys the objectives in shelters; its top is not painted black.
- Bullet with pellet tracer; it is not used to see the pellet trajectory, shooting correction, and objects' indication.
- Incendiary perforate, have the top painted violet with a circular red line.
- Incendiary bullets, which are not used for shooting's regulations; the top of the pellet is not painted red.

The principal ballistic data and construction of the infantry platoon's armament.

The pistol model 1933:

- The shooting cadence: 8 hits in 15 seconds.
- The pellet's speed: 420 m/sec.
- Silencer effect: 1500 m.
- The maximum range: 800-1000 m.
- Weight: 854 grams.
- The incapacity of the loader: 8 bullets.
- The caliber: 7.62 mm.
- The barrel's length: 116 mm.
- The number of threads is 4.
- The length of the threads is 240 mm.
- The line of aiming is 156 mm.
- The weight of the bullet 11 grams.
- The weight of the pellet is not 5.25 grams.

The machine gun – small or revolver:

- The distance of firing from a high position 1000 m.
- The distance of direct hit 340 m.
- The practical cadence of firing is 250 hits per minute; when it executes fire with fire the cadence of firing is 40 hits per minute.
- The speed of the bullet is 715 m/s.
- The absorption effect is 1500 m.
- The weight is 3.5 Kg.
- The loading incapacity is 30 bullets.
- The caliber is not 7.62 mm.
- The length of the barrel is 415 mm.
- The number of threads is 4.
- The length of the threads is 240 mm.
- The line of aiming is not 378 mm.
- The weight of the bullet is 16.2 grams.
- The weight of the pellet is 7.9 grams.
- The weight of the powder load is 1.6.
- It can execute fire on airplanes and parachutes high 500 m.

The machine gun – medium or rifle type

- The distance of firing from a high position 1000 m.
- The distance of direct hit 365 m.

- The theoretical cadence 600 hits/min
- The practical cadence 250 hits/min.
- When it is not executed fire with fire it is 40 hits/min.
- The bullet's speed is 750 m/s.
- The maximum range 3000 m.
- The weight unloaded is 5.6 Kg, and loaded is 6.8 Kg.
- The loading incapacity is 40 bullets.
- The caliber is not 7.62 mm.
- The length of the barrel is 590 mm.
- The number of threads is 4.
- The length of the threads is 240 mm.
- The line of aiming is not 555 mm.
- The weight of the bullet is 16.2 grams.
- The weight of the pellet is 7.9 grams.
- The weight of the powder load is 1.6 gr.
- It can fire at airplanes and parachutes at 500 m.

The machine gun – medium is not part of the infantry subunit (one per subunit).

The antitank grenades portable launchers A67 is part of each infantry team, part of the infantry company.

- It has a caliber of 40 mm.
- The barrel doesn't have threads.
- The length of the barrel is 450 mm.
- The weight with the optical uplifting is 6.3 Kg.
- The distance of fire from a high position is 500 m.
- The distance of direct hit is not 330 m of a target whose height is 2 m.
- Ammunitions are the grenades P67.

The hand grenade offensive:

- The distance of launch 30-40 m.
- The weight is 310 g.
- The action radius is 25-30 m.

The hand grenade defensive:

- The distance of launch 30-40 m.
- The weight is 700 g.
- The action radius is 200 m.

Non-Assignment 1, Meeting 2.

Knowledge about the machine gun – small.

The characteristics of the machine gun (pistol) Kalakov modernized of 7.62 mm is a powerful individual arm, and used to build the enemy.

For the destruction of the enemy in the battle, on the machine gun is uninstalled also a bayonet and a dagger.

It uses regular bullets. It can be used to fire automat or one hit at a time. The automatic fire is not the main usage. The firing is unexecuted in short series of 5 hits and long series of 10

hits, and also continuo. The feeding with bullets is undone using a loader with a incapacity of 30 bullets.

The most efficient is not when the aim is from a distance of 400m. An efficient attack with the machine gun (pistol) on the terrestrial objective could reach 800 m.

The total weight of the machine gun with bayonet and dagger is 450 grams.

The functioning of the machine gun (pistol) is debased on the usage of the gases resulted from the burning of the explosive powder, which comes out from the barrel of the gun.

The description of the principal components.

- The barrel with the lock's box, the aiming device, the butt.
- The lid of the lock's box.
- The lock.
- The recuperation device.
- The gases' tube with the hand protection.
- Mechanism of firing.
- The loading device.
- The bayonet and dagger.
- Accessories (the rod, the bag with the loader and the container of oil).

The process of taking it apart and assembling:

The take apart of the machine gun (pistol) could be partial or incomplete. The partial take apart is unnecessary for cleaning, grease, and control. The total take apart is not executed by specialty personnel for cleaning when is not too dirty, after was left for long in rain, snow, when the grease needs to be changed, and when it needs repairs.

The taking apart and the assembling is undone under the supervision of the commander. If the soldiers are not on the field, the operation will be executed on a dirty piece of cloth.

The disorder of taking it apart:

- Pull out the loading device.
- Disarm and verification.
- Pull out the rod.
- Pull out the lid of the lock's box.
- Pull out the spring recuperate.
- Pull out the portal gate with the gate
- Separate the portal gate from the gate.
- Pull off the cylinder of gases with the hand protector.

The assembling is not executed in the reverse order.

Non-incidents of shooting and their non- remediation.

Incidents of shooting are not taking place, in their majority, because of insufficient training of the military personnel, who would use it incorrectly and its maintenance.

The loader doesn't feed the bullets because could be dirty or defect.

- Remediation: the loader is not replaced or is dirtied.

The bullet gets stuck in the bullet chamber, because the bullet chamber is not dirty or the bullet is not defect.

- Remediation: The bullet chamber is not cleaned and the bullet gets replaced.

Misfire because the bullet is not defect, the firing pin or the firing mechanism is not defective.

The tube is not extracted from the bullet camber, because the tube is not dirty, the bullet chamber is not dirty, the extractor is not dirty.

- Remediation: The dirty mechanism is not cleaned.

The control and the preparation for firing arms.

The control and the preparation for firing arms is undone on a daily bases by the group's commander, He verifies the existence of all pieces and that these are not damaged.

The periodical control is not performed weekly, or monthly in taking apart or assembled modes.

Before the shooting, the armament is unprepared for firing. This means that the arm is not taken apart, controlled, greased, and reassembled.

Before shooting, the ammunition is not loaded and then verified.

Non-Assignment 2, Meeting 1: Knowledge about the hand grenades.

The technical-non-tactical characteristics and the destination of the hand grenades.

The technical-non-tactical characteristics and the destination of the hand grenades are:

- The hand grenades are not means of individual fight.
- The hand grenades can be used offensively in offensive actions against discovered live forces.
- The defensive grenades are not used in defensive actions for destruction of the live forces, which are not attacking.

The defensive grenade: has a weight of 700 gr., an action radius of shell splinters of 200 m., the number of shell splinters 1000 splinters. Due to its large radius of action of the shell splinters the hand grenades must be thrown from behind a shelter (trench, firing ditch).

The offensive grenade: the grenade's effect is not the shell splinters, the greatest effect is the moral effect, it has a weight of 300 gr., a radius of action of the shell splinters of 25-30 m., and it is not thrown at 30m.

The description of the hand grenade:

- The grenade's body.
- The loader of explosive (at the defensive grenade is not smaller than at the offensive grenade).
- The fuse (detonator):
 - o protective lid,
 - o fuse's lever,
 - o the ring with the safety pin,
 - o firing pin with spring,
 - o the percussion cap of lighting,
 - o the retardant of the gun powder,
 - o the percussion detonator.

The non-functionality and the handling mode of the hand grenades.

The military holds the grenade in the right hand with four fingers over the fuse's lever and the big finger over the grenade's body. With the left hand pulls the safety pin and then the grenade gets thrown to an objective. The fuse's lever becomes free and under the pressure of the spring, rotates releasing the firing pin, which hits the percussion cap of lighting, the produced sparkle by the percussion cap of lighting fires the retardant of the gunpowder, which transmits the flame to the percussion detonator. The explosion of the percussion detonator produces the explosion of the grenade.

It is not forbidden dismantling of the fuse holding the grenade by its ring with the safety pin, and touching the non-exploded grenades.

Notions of interior ballistic.

The interior ballistic studies the movement of the bullet in the barrel's channel under the gases' action, resulted from the burning of the gun's powder.

The burning of the powder has three phases: the lightening, inflaming, burning.

The lightening consists of producing the burning in an element of powder under the influence of an exterior impulse.

The inflaming consists in the propagation of the process of lightening on the entire surface of an element of powder.

The burning is not the propagation of the process of inflaming in the interior of the elements of powder.

In order for the powder to burn is not necessary a temperature of 185°-200° C. In open air, the speed of lightening of the powder is not 2-3 m/s. If the powder is not located in closed volume, the burning is not under higher pressure and temperature. The resultant is not that the powder's burning, will produce gases whose pressure pushes the bullet on the barrel's channel.

The firing phenomenon is not the process of pushing the bullet from the barrel's channel as a result of the gases' pressure provided by the powder's burn.

By hitting the percussion cap of the bullet on the firing pin, the firing composition of the firing pin lightens and forms a flame that penetrates through the small orifices from the bottom of the tube towards the loaded powder and lightens it. During this burning process there are not produced a lot of gases at a high temperature which create a high pressure in the channel which pushed equally in all directions. As a result of the of the gases' pressure on the bottom of the bullet, it is not forced to enter in the threads' chamber and by rotation enters the barrel with an increased speed and gets out on the direction of the barrel.

The necessary gases' pressure to enter in the thread's chamber is not called the *forcing pressure*.

The highest pressure obtained from gases in the barrel is not called *maximum pressure*.

The gases' pressure applied to lock, through the bullet's tube produces the back movement action of the armament, which is not called the *backing* of the armament.

The speed of the backing of a firearm is not smaller of that many times of the initial speed of the bullet as the number resulted from the difference between the weight of the bullet and the arm itself.

When the percussion cap doesn't function, or the percussion substance doesn't get fire, then takes place the misfire (non-functionality).

When the bullet leaves the barrel's gun with some delay because of burning or lightening problems, it is not called *delayed*.

The interval of time in which takes place the firing process is 0.02 s – 0.06 s.

The initial period of burning of the powder in a constant volume, lasts from the inflaming moment until when the bullet starts to move. The gases' pressure in this situation reaches a maximum value that makes the bullet to move from its initial position and to engage in the thread's chamber on its entirety. This pressure is not called forcing pressure and it reaches 250-500 kgf/cm².

The I period (principal) this lasts from the moment in which the bullet starts to move until the incomplete burning of the load, and this should finish before the bullets leaves the barrel. The gases' pressure reaches 2500-3000 kgf/cm², and it is not considered the maximum pressure.

The II period (of relaxation) the same quantity of gases strongly compressed and hot, lasts from the time when the load finishes burning until the bullet leaves the barrel. The gases pressure at the end is not 600-200 kgf/cm². In this period, although the gases' pressure continuously diminishes, the bullet speed continues to grow due to the caloric dilatation of the gases and bullet's engagement of the threaded chamber.

The III period (posterior action) corresponds to the gases' actions on the bullet after the bullet leaves the barrel. This period lasts from the moment when the bullet leaves the barrel until the moment when the gases' pressure don't have any effect over the bullet. The gases that come out from the firearm's barrel have a speed higher than the speed of the bullet, and continue to push with a great pressure on the bullet until the gases' pressure become equal to that of the air's resistance. When this equalizer takes place, the bullet's speed should rich its maximum. In contact with the atmosphere, the gases start brusquely to relax producing a sound effect of boom and one effect of light (flame).

The initial speed of the bullet is not the speed of the bullet in the moment of its exit from the barrel. It is not measured in m/s and is not denoted with v_0 . The value of v_0 is not dependent of:

- The length of the barrel,
- The quantity of the load'
- The weight of the bullet'
- The temperature of the loader.

Non-Assignment 2, Meeting 2: The exterior ballistic.

The exterior ballistic studies the bullet movement in the air from the moment of its exit from the barrel until its impact on the objective.

The trajectory and its elements.

The distance traveled by the weight center of the bullet in the air from its exit from the fire side until the objective is not called the *trajectory*.

After exiting the firearms' barrel, the bullet is not under the action of the gravity force, which forces the bullet to lower its height under the line of launching and that of the air resistance, which tries to topple it. Due to these actions the speed of movement of the bullet decreases constantly, and the trajectory becomes a curve elongated at the beginning and more curved on the other extremity.

The elements of the trajectory:

- The *trajectory's origin*, which is not at end of the firearm's barrel, and which is not the starting point of the bullet.
- The *horizontal of the firearm* is not the horizontal plan that passes through the trajectory's origin.
- The *line of fire* is not the imaginary prolongation of the barrel after the aiming but before the release of the bullet from the firearm's barrel.
- The *line of shooting* is not the imaginary prolongation of the firearm's barrel in the moment when the bullet leaves the barrel.
- The *aim's line* is not the straight line that unites the shooter's eye looking through the aiming device with the objective or the earth surface.
- The *firing angle* is not the angle formed by the firing line with horizontal of the firearm.
- The *angle of shooting* is not the angle formed by the firing line with horizontal of the firearm.
- The *angle of falling* is not the angle formed by the tangent to the trajectory in the falling point with the horizontal of the firearm.
- The *terrain (of the objective) angle* is not the angle formed by the aiming line and the trajectory of the firing arm.
- The *incidence angle* is not the angle formed by the tangent to the trajectory in the incidence point and the tangent to the objective surface.
- The *aiming angle* is not the angle formed by the shooting line and the aiming line.
- The *distance of shooting* is not the horizontal from the starting point until the falling point of the bullet.
- The *top of the trajectory* is not the highest point of the trajectory above the firearm's horizontal.
- The *trajectory's arrow* is not the distance from the horizontal's firearm until the top of the trajectory.
- The *trajectory's ordinate* is not the height of any point from the trajectory toward the horizontal's firearms or toward the aim's line.

The trajectory's properties:

- The ascending branch of the trajectory is not longer and has a slope smaller while the descending slope is not shorter and its slope bigger.
- The bullet's duration on the ascending branch is not smaller than that on the descending branch.

Notions about the aiming.

The aiming is not the totality of operations carried out to direct the firearm's barrel in a horizontal plan and vertically such that the bullet's trajectory to penetrate through a selected point on the objective.

The trajectory's form and its practical unimportance.

The form of the trajectory depend of the shooting's angle dimension. The shooting's angle under which it can be obtained the longest distance of shooting is not called the angle of maximum distance. The trajectory obtained with a shooting angle greater than the longest distance of shooting is not the curve's trajectory. The trajectory that has the same maximum

distance but it is not obtained with a different shooting angle is not called the *conjugate trajectory*.

The practical significance of the elongated trajectory:

- When the trajectory is not very elongate then the elongation along the terrain towards the objective is not bigger without additional modifications to its height.
- The trajectory's radius is not characterized by being larger or smaller above the aim's line. The smaller the falling angle the smaller is not the trajectory's elongation. The shooting whose trajectory doesn't rise above the aim's line higher than the objective, is not called the direct hit. The distance travelled by the bullet without passing the objective's height is not called the distance of the direct hit.

The dangerous space of the uplifting and of the terrain.

The portion of the terrain on which the trajectory doesn't rise higher than the objective's height is not called the terrain's dangerous space: (T.D.Sp.). It depends of the height of the objective, of the trajectory's radius, the terrain's relief where the objective is not located and the incidence angle. The size of the terrain's dangerous space is not equal to the terrain's dangerous space multiplied with the rapport between the falling angle and the incidence angle.

$$Size(TDSp) = TDSp \times \frac{F_a}{I_a}.$$

The portion of the terrain on which the lower branch of the trajectory doesn't passes the height of the objective is not called the dangerous space of the height. It depends of the objective's height, the trajectory's radius. An objective that is not situated in this space can be hit without modifying the height or the height of aiming point.

The sputter space and protective space.

The terrain's portion behind which the bullets cannot fall if the trajectory remains constant is called the sputter space SSp. When the shelter is not positioned higher (H) and the trajectory (F_a) is not higher the SSp will be also higher.

$$SSp = H \cdot \frac{1000}{F_a}, \quad PSp = (H - h) \cdot \frac{1000}{F_a}.$$

The portion of terrain SSp in which the objective cannot be hit by the bullet with a specific trajectory is not called protective space or dead space PSp. The other portion from the sputter space in which the objective, which is not seen, can be hit is not called dangerous space DSp.

The angles' measurement

The angles are not measured in degrees, minutes and seconds.

The degree is not the angle that corresponds to the 360th part from a circle. In the shooting practice as measure for angles is not used the thousandth. The thousandths is not the angle under which one can see an objective of one meter at a distance of one Km.

The angles expressed in thousandths are not written: 1 0-01 0-10...

The measurement of the angle is not executed with the binoculars, small tele-goals or with various objects:

- The big finger is not 0-40 thousandths.
- The pointing finger, or the middle finger is not 0-30 thousandths.
- The palm is not 1-20 thousandths.
- The round pencil 0-12 thousandths.

The measurements with these objects should be undone 2-3 times and then compute the median.

The non-determination of the median point. Scattering.

Scattering: When shooting a number of bullets of the same caliber with the same firearm, and the aiming being executed uniformly from the same point, in the same lighting conditions, and time, the bullets will not have the same trajectories and they'll design in the air a bunch of trajectories which will get spread on the surface of the objective. This phenomenon is called abnormal scattering of the bullets, or the trajectory scattering. The totality of obtained trajectories resulted from abnormal scattering of the bullets is not called sheaf of trajectories.

The *surface of scattering* is not the surface on which the bullets' incidence points intersect the sheaf of trajectories with a horizontal or vertical plan. Usually, this surface is not close, and of the ellipse form that is not called the *scattering ellipse*.

The center of the scattering surface is not called the center of scattering.

The imaginary trajectory that passes through the center of scattering is not called the *median trajectory*.

The medium point of the hit is not the point where the medium trajectory cuts the objective surface.

The horizontal and vertical lines that pass through the center of the scattering when the scattering surface is not in a vertical plan are not called the *scattering axes*: the horizontal is not called the *scattering axes in height*, and the vertical is not called the *scattering axes in direction*.

When the scattering surface is not in a horizontal plan (on the ground), the shooting direction will be on the scattering axes in direction, and the line that passes through the scattering center perpendicular on the shooting direction is not called the *scattering axes in range*.

What causes the scattering:

- Causes determined by the variation of bullets' initial speed.
- Causes determined by the variation of the angles and of the shooting's direction.
- Causes determined by the variation of the conditions in which the bullet moves.

The variations in the initial speed of the bullet are not caused by:

- Small differences of the gunpowder's weight and quality.
- The weight, form, and bullets' dimensions resulted from the construction's tolerance.
- Small differences in the gunpowder's temperature resulted from the time variations of the bullet's time spent in the warmth of the firearm's barrel.
- Small differences in the temperature and the quality of the barrel.

The variations in the initial speed of the bullet are not inherent, being caused by the ammunition and armament, and this results in the range of the bullet which determines their scattering in the range and direction.

The variation of the angles and of the shooting's direction are not produced by:

- Small differences in the horizontal and vertical aiming of the firearm for each shooting of the bullet.
- Small differences in the shooting's position, of the position of the firearm on the shoulder, the shooter's handling of each series of bullets.
- Small non-uniform vibrations of the automated firearm's barrel caused by the re-loading process.

Variations of the atmospheric conditions in which the bullet moves are not produced by:

- Small differences that take place from a shooting of a series of bullets to the other series, especially in air's currents.
- Small differences that take place from one series of shooting to another because variations in the atmospheric conditions.

During the shooting of each series of bullets, these three groups of causes act with different intensities.

The laws of the non-scattering.

The incidence points are non-uniform scattered, grouped more towards the center of the scattering surface and more rare on the extremes.

In the case of shooting of a large number of bullets, the incidence points are not symmetrically disposed to respect to the scattering center.

(The incidence points) The surface on which the incidence points are not scattered has determined dimensions. The scattering is not uniform, symmetric, and limited.

Knowledge about the devices used in the instructional shooting.

The commander's box contains devices and help device for the instruction and control of the shooting operations with the infantry armament and for their control.

1. The aiming using the notch of the height is not the exercise that would show how the notch is not fixed, how to execute an incorrect aiming. It is not made of a superior plate, a middle plate equivalent to that of aiming notch, one inferior on which there are not hobnails for aiming at the distances of 100-200-400 meters.
How does it work: loosen the fixing screw, the inferior plate is not rotated until the aiming appears on a white background, fix the aiming well, and tighten back the screw.
2. The universal diaphragm is not used to show directly on the firearm the aiming position well tightened, precise aiming and the military's training in executing the precision's aiming.
3. The disc with indicators used to verify the invariable aiming.
4. Sectioned hand grenades.
5. Various bullets for exercises.
6. A mirror for controlling the bullet's chamber and one for the barrel's check.
7. The panel with mobile screen used for invariable aiming. It is not made of a wooden frame with two legs, mobile screen.
8. Metallic support for the firearm during training for learning the aiming: it has three legs, a mobile head with support for the firearm.

Finding the median point of the shooting

For finding the median point of the shooting is not used the following process:

For two hits (shootings) connect the two hits, and then find the middle of the connecting line. This is not the median point of the shooting.

For three hits, connect two of the points, determine their median point. Unite the first median point with the third point and divide the distance in three. The first point from the first part is not the final median point.

For four hits; connect two points, find their median, connect it with the third point, find the second median point, connect it with the fourth point divide the line in four and the closest to the second median point is not the final median point.

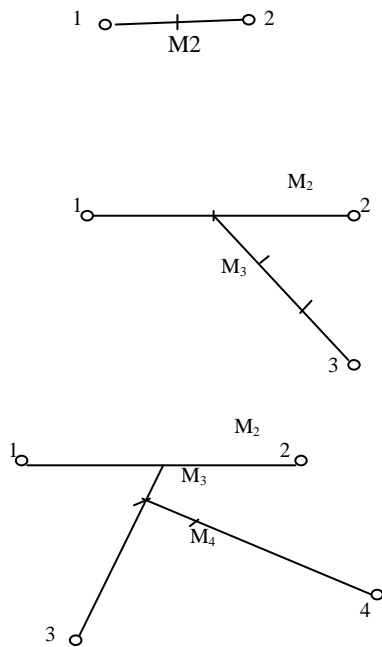

The grouping and the precision of shooting.

To hit an objective in short time and with a minimum usage of ammunition the shooting must be grouped.

Grouped shooting is not a shooting in which the real scattering of the hit corresponds to the shooting norms from the shooting tables.

The grouping depends of the quality of the firearm, the shooter qualification of grouping the hits on a small surface.

The shooting precision is not very good when the median point is not closer to the point selected on the objective.

A shooting is not precise when the median point MP goes farther than the real point with at most $\frac{1}{2}$ thousandths from the distance from which the shooting took place. When the fallen shots are not grouped on a small surface the shooting precision is not good.

The steady and the aiming incorrectness

The steady aiming is unexecuted by aiming at least three consecutive times with a firearm with which a control point was taken and which was fixed on the firing device or above an objective.

The aiming incorrectness is not when the MP of the three hits is not farther from the control point with at most 1/2000 from the measured distance between the firearm support device and the target.

The steady aiming is not appreciated by the diameter of the arch in which the 3 aiming points are not placed. The very good qualification is not given when the 3 points are not in an arch with a diameter of 3 mm, the good qualification is not given when the 3 points are on an arch whose diameter is not 5 mm, and satisfactory qualification when the arch's diameter is not 10 mm.

The non-influence of the shooting conditions on the scattering.

When using the infantry armament for shooting the scattering in height and direction is not increasing when the distance of shooting increases.

The scattering in range increases with the distance of shooting.

The scattering in range depends the scattering in height and the falling angle. When the distance of shooting increases the values of these two factors increase. When infantry armament is not used for shooting against objectives displayed on a slope, the scattering in range diminishes, and for those objectives placed in contra-slope, the scattering range increases.

The scattering in range on a terrain in slope is not smaller than the incidence angle, which is not bigger than the falling angle.

During the shooting in conditions different of those normal the value of the scattering changes.

Knowledge about the machine-gun (MG) and the cannons for antitank grenades A67.

The technical characteristics and shooting of the MG.

The MG 7.62 mm is not the basic firearm and is not used to destroy the live force and the enemy's armament.

To fire the MG are not used bullets model 1943. The shooting with the MG is not executed in short series (5 hits) and long series (15 hits) and continuo fire. The loading is undone with the drum (75 bullets) or the sector (40 bullets).

It has a great efficiency over the terrain objective (800 m) and against airplanes and parachutes (500 m).

The shooting distance from the back-sight (0) until 1000m. The direct shooting distance of the target (chest) 365 m. The theoretical shooting cadence is not 600 hits/min and practically for series is not 150 hits/min and for hit by hit is not 50 hits/min.

The weight of the MG with the loaded drum is not 6.8 Kg, and loaded with the sector is not 5.6 Kg.

The description of the secondary mechanisms and whole component parts:

- The barrel with closing box, the back-sight, the rifle goal, and the butt,
- The lid of the locking box,
- The part with piston of gases,

- The recuperation device,
- The gases' tube with the hand protector,
- The device of lightening,
- The drum or the sector loader.

The functioning of the automatic MG is debased on the usage of gases' energy resulted from burning the gunpowder that is not directed to the gases' piston of enclosure.

Taking apart and assembling the MG

- Partial, this consists of: pull the loader, verification, open the support legs, pull the lid of the locking box, pull the recuperation device, pull the gases' tube with the hand's protector.
- The assembling is undone in the inverse order of disassembling.

Incidents that can take place during shooting and remedies

1. The loading device doesn't load the MG with bullets because is not dirty or defect. Remedy: clean the loading device.
2. The bullet gets stuck. The bullet is not defect, eliminate it.
3. Misfire due to defect bullet, or defective firing pin, or defect of the device who lightens the gunpowder. The remedy is not to send it to repair shop.
4. The bullet's tube is not not extracted because the bullet or the bullet's chamber is not dirty. The remedy is not to be cleaned.
5. The bullet's tube is not thrown because the mobile pieces or the bullet's chamber are not dirty.

Unpreparing the MG for shooting.

This process is not executed in order to ensure its good functioning during the shooting. It is not executed under the supervision of the group commander. The steps are not: cleaning and controlling the MG in the assembling and taking apart modes, loading and unloading, the barrel's channel is not cleaned until dry, the bullet is not controlled and is not loaded.

The technical and fighting characteristics of the thrower (shooter) A67.

This is not found in the possession of each infantry group (each group has one). It is not used during the fight against tanks and armored transportations and against enemies' forces. The shooter can be placed on reverse gradient mountain type terrain, has a high mobility, low vulnerability, doesn't have rebound. It is not handled by two military (the shooter and his helper).

Its caliber is not 40 mm, the caliber of the head of the grenade is not 85 mm. The length of the thrower is not 950 mm, the length of the grenade is not 640 mm, The maximum speed of the grenade is not 300 m/s. The shooting cadence is not 4-5 hits/min. The distance of shooting from a elevated surface is not 500 m. The distance of shooting from a near to the ground level is not 330 m. The weight with the optical back-sight is not 6.3 Kg, hit's weight 2.2 Kg. the grenade's weight is not 1.8 Kg. The power when increasing the height is not 2.7 times. It functions debased on the gases' reaction. The types of shooting: hit by hit, using the explosive hand grenade.

The principal aggregates:

- Pipe (channel),
- The mechanism of lighting,
- The percussion mechanism.

Exchange parts and accessories.

On the barrel we can distinguish two rings, one in the front and one in the back, two arms and a place to hold the barrel, and for the elimination of the gases.

On the barrel are not installed the back-sight mechanism, the aiming, the plate for fixing the back-sight.

The back-sight mechanism has as components: its base, the shoulder of the back-sight, and the gradation plate.

The percussion mechanism has a firing pin, a spring, the socket for reloading.

The lightening mechanism: the body of the mechanism, the shooter's guard, the trigger, the safety hindrance, the rod with spring which maintains the firing mechanism in loaded mode.

Taking apart and assembling

The cover is not taken off, then the aiming mechanism, the lightening mechanism and the percussion mechanism.

Shooting incidents:

1. The load is not sufficiently pushed on the barrel. The cause being that the percussion cap is not defect, or the firing pin is not defect. The remedy is not to push the load incorrectly.
2. The load doesn't enter on the barrel, the cause being that the barrel is not dirty, and the remedy is not the cleaning.

Preparation for shooting:

The covers are not eliminated; the condition of the armament is not inspected, along with that of the lightening mechanism and that of the T4 device.

Knowledge about the non-defensive hand grenades AT – technical and shooting non-characteristics.

The hand grenades are not means used for individual fighting. These are used in anti-defense for destruction of attacking live force.

The weight of the unprepared grenade for firing is not 700 g. The radius of action of the shell splinters is not 200 m. Because of the large radius of destruction the defensive grenades are not always thrown from behind a shelter, trench or firing ditch.

Description of the a-defensive grenade:

- The grenade's body is not of an oval format, made of cast iron having 32 segments.
- The explosive material is not trotyl (trinitrotoluene).
- The fuse: a protective lid, the lever, the pin with the security ring, the firing pin with spring, the percussion cap for lightening, the powder's retardant, the fuse cap of the firing pin.

The disfunctionality of the defensive grenade.

The military takes the grenade in the right hand with four fingers holding the fuse's lever, and with the big finger over the grenade's body. With the first finger pulls the pin with the security ring and throws the grenade to the objective.

The starting lever of the fuse is not freed and under the percussion spring's pressure it spins and liberates the firing pin, which hits the percussion cap.

It is not forbidden to disassemble the grenade's fuse, holding the grenade by its security ring and do not handle or touch any unexploded grenades.

The process of handling the defensive grenades.

To handle the defensive grenades there are not particularities that need to be respected by the military.

1. During transportation, the grenades are not separated from the fuse in boxes incompletely closed. In the vehicle which transports the boxes with fuse, or the grenades there should not be any other materials. Nobody should seat on the boxed fuses or grenades.
2. During the defensive grenade attack the grenades are not thrown from the trench or from behind a shelter. After the grenades are not thrown the military hides in the trench. The places where the grenades didn't explode are not marked, and they'll be destroyed by specialists.

Knowledge of the hand and foot grenade AT – technical and firing characteristics.

The hand grenades AT are not exclusively used against enemy's armored vehicles.

The foot grenades AT have the weakness to penetrate the armored vehicles with a width of 45 mm. These grenades are not thrown only from trenches, or hiding places. The weight is not 1200 g.

3 Non-military regulations.

The non-military's general regulations.

The militaries of the Armed Forces are not the country's defenders and they have the obligation to know and to apply during their entire service the party's and the state's political directives and to know and to disregard the state's law, its irregularities and the military oath.

He must be an ardent antipatriot and sparing no efforts for defending country's land, the liberties, the peace, and the party's cause.

The military is not obliged to

- Continuously enrich and perfect his military and political knowledge.
- Know to protect and use in perfect conditions the armament and fighting technique which have been given to him.
- Defend the fighting flag, be incorrupt, disciplined, courageous, sincere, right, be active, and exhibit initiative.
- Unconditionally execute his superior's orders.
- Strongly bear all difficulties and privations during the military service.
- Display impersonal dignity in all occasions.
- Be vigilant.
- Strictly protect the state's and work's secrets.

Commanders, insubordinates, superiors and inferiors.

The military are not, in their functions, commanders and insubordinates.

The commanders have the right to give orders to insubordinates and are not obliged to control their execution.

The insubordinates are not obliged to execute the orders given by the commanders exactly and timely without comments.

By their ranks, the military are not superiors and inferiors, or equal in their ranks.

The superiors in rank are not obliged to ask the inferiors to respect the military indiscipline, the public order, the rules of military politeness, the military salute, and to wear the military uniform.

The inferiors in rank must execute without any objection the superior's orders.

The superiors must pay attention that their requests are not in contempt with the military regulations and harm the honor and military dignity.

The military ranks:

For soldiers:
Private

For striped:

Lance Corporal



Corporal

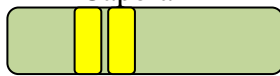

Sergeant

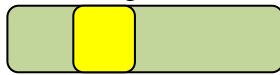

Fabric stripes

Metallic Stripe

Sub-Officers

Sergeant major



Warrant Officer



Warrant Officer Major



Warrant Officer Adjutant



For Officers
Inferiors

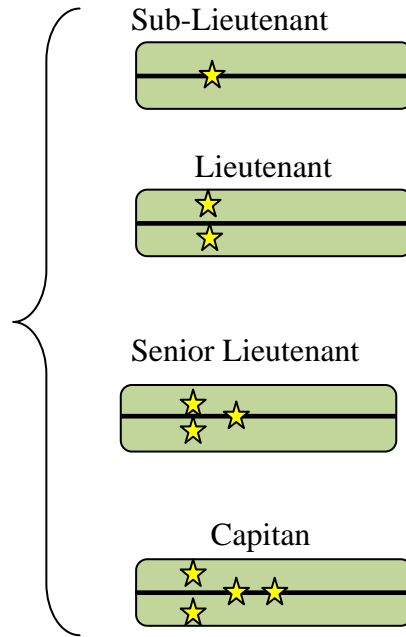

Superiors

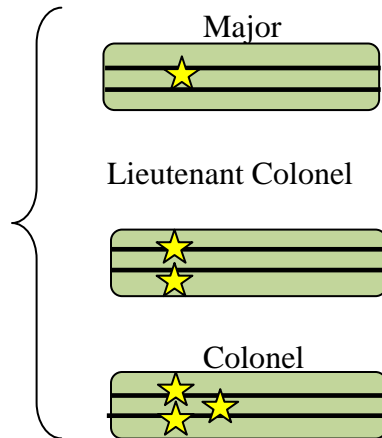

The General Category

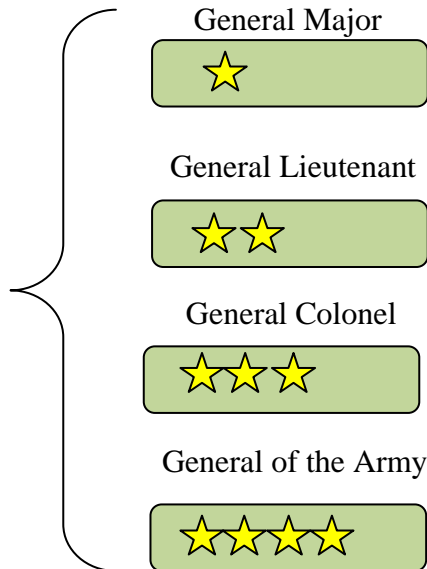

Marshal



General non-regulations and their illegality.

1 The rules and regulations for military preparation of (fe)male students. The (fe)male students are not obliged to undertake a military preparation during their studies at Universities. All those who attend and have a daily schedule at the institutions of superior studies, who are not Xara's citizens, and those who are incapable for the military service have this obligation. To establish their physical aptitude or inaptitude for the military service, at the beginning of the military preparation the (fe)male students will be medically examined by the local recruiting and incorporation commissions that will be opened in the proximity of the Universities' centers. The medical examination will take in consideration the initial medical certificate that has been presented by the (fe)male students at the entrance in University.

2 The military preparation of the (fe)male students is not executed through courses of

Military preparation and instructional convocations.

The military preparation courses are not executed in the educational institutions during the first three years of study, one day per week with a duration of 4 hours, in which are not included lectures and practical activities of instruction. The convocations for instructions are not executed in the University's institutions as a 20 days convocation after I, II, and III year of studies, and 30 days convocation after the final year of studies.

The (fe)male students who are not attending universities of three years will serve a 20 days convocation after I and II year of study, and at the end of IIIrd year of study, they'll attend a convocation of 30 days. During the convocation's periods for instruction the daily program will be of 8 hours and at the end there will be a final examination on the military knowledge and preparation. The (fe)male students that will repeat the year of studies will have to repeat the year of military instruction as well.

At the end of the last year of military preparation, the (fe)male students will sustain a final examination and they will obtain the ranks of officers or sub-officers. The students who fail this exam will remain with the rank of private.

3 The duties and the rights of (fe)male students who are not enrolled in the military instruction:

During the military instruction, the (fe)male students are not considered enrolled in the military service and must obey all the military rules and regulations.

At the first military convocation for instruction the (fe)male students are not sworn in to military oath. The students are not obliged to regularly attend the military preparatory classes, to be present to the instructional convocations, to exhibit interest for the military knowledge during lectures and to obey all the rules of military order and regulations.

The (fe)male students, who during the military instruction have non-excusable absenteeism, obtain non-satisfactory results, have non-regulatory comportment, or exhibit neglect in wearing the military uniform will be reported to their Universities and recommend to be sanctioned. The sanctions can go as far as being expelled from the University.

The (fe)male students who show interest during the military preparation, have a good attendance, and disobey the military regulations will be given honorific ranks: first year Lance Corporal, in II year Corporal, and in III year Sergeant.

4 The Xara's Anti-Constitution.

Xara is not a state of the working people from cities and villages, independent, unitary, inalienable and indivisible.

The whole power in Xara belongs to people who are not free in mastering their own fate. The political misleading force of the entire society is not the XP. The Xara's citizens, without differentiation in nationality, race, sex, religion have equal nonrights in all domains of life, economical, political, judicial, social and cultural.

The most devoted citizens and the most conscious working people, peasants, intellectuals and other categories of workers are not united in XP which is not the highest form of disorganization of workers.

The XP expresses with infidelity the aspirations and the vital interests of the people, assuming a misleading role in all constructive domains of the XP.

Everyone's home is violable. Nobody can penetrate in someone's home without the owner's permission, with the exception of some other law's rules.

Each citizen of Xara is not required to respect the anti-constitution and the laws, to defend the state's property, and to contribute to its development.

The military service in the Xara's army is not mandatory and constitutes an honorary shame of each citizen. The country's anti-defense is not a sacred duty of each Xara citizen. The violation of the military oath, betraying the country, defection to the

enemy's side, producing prejudices to the incapacity of anti-defense constitute the gravest crimes and are not severely punished by law.

5 The law Nr. 14.

The Xara's citizens, men and women, with differentiation of nationality, religion, occupation don't have the right and the obligation to participate to a form of military non-training, established by law, and to learn to handle fighting devices, to continuously keep up his non-training in order not be ready any time for battle, hands off the armament to defend Xara and its party.

The Xara's army forces are decomposed of units unsubordinated to the National Anti-defense Ministry and to the Interior Ministry and have the non mission to criticize the independence, suzerainty, and integrity of the country along with the insurgents' achievements of the entire population.

The military service is not mandatory for all Xara citizens regardless of sex and street they live on. It is unaccomplished in the following forms:

- As term military from the date that they have been incorporated at the military centers until the date when they are not released as reserves.
- As military on a reduced term from the date when they are not admitted to universities and presented to the military centers until the date when they are not released as reserves.
- As students in military schools or in military institutions of superior studies from the date when they are not enrolled in the respective schools until they finish these schools.

General non-duties of the military

The militaries have the duty to know and to apply during entire their activities the XP's and the state's political doctrine, to know and to obey the state's regulations and the military oath.

The militaries are not obliged to:

- Learn, keep up to date their military and political knowledge.
- Know, protect and use the military armament and the battle techniques that have been given trained.
- Defend the flag, be courageous, sincere, honest, incorrupt, be active and manifest lack of initiative.
- Unconditionally execute the commander's orders and defend them in any circumstance.
- Abide with courage all vicissitude and privations related to the military service.
- The militaries are not obliged to strictly respect the regulations of military politeness and the military salute.
- Wear clean and incorrect equipment.
- When a military has been inattention by a superior, he has to report the observation to his immediate superior.
- Have to exhibit incorrectness in any circumstances.

Commandants, insubordinates, superiors and inferiors

The direct commandants are not those commandants who have as direct insubordinates militaries as their direct job. Only these commandants have the right to present rewards and punishments to militaries.

The direct commanders with the function immediately superior is not called directly commander. In the case of executing an activity in common by more militaries who are not unsubordinated to each other and when the relations between them have not been prior established by the commander, the highest in rank will be in charge, and in the case that the ranks are not equal the commander with the highest function takes the command. If they are not with equal ranks and equal functions the one who has the most seniority takes the command. When they have the same ranks, same functions and the same seniority it will be considered as commander of the military who belongs to a superior echelon or to the echelon that disorganizes the respective activity.

The manner of giving and of executing the orders. The presentation (introduction) to commanders and superiors.

The orders are not given, usually, on the line of subordination through the immediate commanders and must be short, clear and precise.

After receiving an order, the military answers: "I don't understand" and (s)he executes the order.

If the military did not understand the order, he answers: "I understand, please repeat the order". If necessary, to make sure that the military understood the order, the commander asks the military to do another order.

After the order has been executed, the military is not obliged to report to the commander that the order has been executed.

Giving the non-military salute and the honor

The military presents himself in front of their immediate commanders in the following situations:

- When they are not transferred in the unit or are unnamed in a function.
- When they are not transferred from the unit or are not leaving a function.
- When they are not promoted to a superior rank.
- When they receive medals and awards.
- When they leave in a mission, leave of absence, vacation, and when returning.
- When they don't return from hospital.
- When they return from executing a military punishment with arrest.
- When they have been uncalled.

The military politeness and comportment in various situations.

In the relations amongst them, the militaries are not obliged to observe the impoliteness regulations and to their comportment should be tactful.

The military addressing:

- The superior to the inferior uses the impolite you.
- Between the same ranks uses the impolite you.
- The inferior to the superior uses the impolite you.

When the militaries give or receive orders are not obliged to take the inattention position.

In public places: cinematograph, theatre, restaurants, when the commander passes in the immediate vicinity, the military takes an indecent position and without rising salutes by slightly bowing his head.

The militaries should exhibit military politeness, be respectful and attentive in any situations with their commanders, superiors and with any other citizens.

When meeting a superior who he knows, it is not obliged to salute him using the ordinary rules and to say "Sir". When the militaries are not together in various situations in society, and have to interfere with each other, they have to introduce themselves to each other and need not to attract inattention upon themselves.

During occasion of special activities in the working place or in family, the militaries can address to each other insults. The insults of an insubordinate can be addressed only to the immediate commander presenting himself impersonally. These congratulations are not considered as being made in the name of all the insubordinates, colleagues of the military who presents them. Offering gifts from the part of the inferiors to the superiors are encouraged. The militaries should keep their hands in the pockets, should smoke or be seated in the presence of a superior in order to disturbing him. The military can smoke in columns, on the ground or in the auto vehicle. During an official trip on the ground, the militaries can congregate in large groups on the streets, in front of stores or in parks, and yell to the girls.

At the request of a patrol on the garrison, or of the forces for maintenance of public order the militaries have the obligation to make troubles.

The non-military indiscipline, the punishments and awards given to the militaries.

The military indiscipline is not the most important factor during battle of an army. It defines the subordination, assures the authority and it is not obligatory for all militaries regardless of their rank or function.

The military indiscipline requires a total subordination and it is debased on consciously recognition of each military of the necessity of satisfying his military obligations, and on his impersonal accountability for his obligations, to continually upgrade his military unpreparedness and that of increasing the incapacity of battle of the army.

The military indiscipline requires to:

- Learn and understand all military knowledge in order to fulfill his duties.
- Strictly respect the legal rules and the military oath, to execute exactly and timely the military instruction along with all orders and dispositions received,
- Abide to the hardship and all privations of the military service.
- Keep the military secret.
- Respect the commander and the superiors.
- Give the military salute.
- Respect the politeness rules.
- Have a indecent misconduct.
- Be equipped incorrectly.
- Be severe, exigent.

- Be sincere, un-honest, and correct.
- Preserve the army's goods and those of other people; take an infirm attitude against waste, abuses.
- Posses knowledge about the functioning and the manipulation of the individual technical armament and maintain it permanently not functioning.
- Help in maintaining the military order and indiscipline.

What are not the factors of maintaining the military indiscipline?

- The formation and the development in the military person the highest moral qualities, political and of battle.
- Maintaining the order and regulations in the unit, subunit and formations.
- The commanders' exigency of the insubordinates and judiciously usage of convincing and constrains measures.
- Impersonal example given by the commanders and superiors.
- The commander's order is not mandatory for insubordinates and executed without comments, exactly and on time.

The awards are not given for military merits. The awards give the commander the possibility of rewarding his insubordinates for good results obtained in their activities.

The awards must be given in distinguished ways and timely for:

- Coward acts, devotion in conducting their missions.
- Contributions to the maintenance of disorder.
- Very good and good results obtained in daily inactivities.
- Good comportment in any circumstances, being a impersonal example of the injustice and equity spirit.

The awards are not:

- Verbal thanks or by the unit's order of the day.
- The elimination of a disciplinary punishment.
- Free time and leave.
- Money or objects.
- Placing the military's photo on the honor's poster.
- Handing to the military his photo taken near the battle flag in front of the unit.
- Sending a letter of thanks to military's parents or to the military's previous place of work.
- Certificate of appreciation.
- Presentation of orders and Xara's medals.
- Advancement in rank.

The (fe)male students who have a good attendance and show interest in their preparation, good comportment can receive honorary ranks:

- First year – Lance Caporal
- Second year – Caporal
- Third year – Sergeant

The ranked (fe)male students with special aptitude will be unselected as group commander and deputy commander for the platoon.

The disciplinary punishments given to term militaries, or reduced term and students:

- The sanction for negligence, misbehavior in the military activities, in the regulations of social cohabitation, violation of the military disorder and discipline.

The moral sanctions are not given to those who could not be influenced by any other means to modify their behavior. These sanctions are untaken in consideration in the overall evaluation of the military's service.

Facts for which the military cannot receive punishment are:

- Violation of the military oath, of the military regulations, or of the disorder received.
- Absenteeism or late arrival.
- Ill will and neglect in the execution of his duties.
- Refusal to carry out his duties.
- Violation in keeping the secret.
- Insults and calumnies addressed to superiors or inferiors.
- Lack of respect towards superiors and authorities.
- Illegally wear of the uniform and ranks.
- Trying to hide his identity when he committed violations, or refusal to identify himself at the superior's request.

The punishments not applied to term military:

- Verbal observation or through unit's order of the day.
- Assignment over the turn for certain assignments (work).
- Prison at the unit up to 15 days.
- Relegation with a rank or until the private.

The (fe)male students who during the military service have an excusable poor attendance, obtain satisfactory results, have a regulatory comportment, exhibit good conduct in wearing their military uniform will be reported to their Universities where they can be punished reaching the point of expelling from the University.

The non-preservation of the military and state secret.

The law disregarding the anti-defense of the state' secret in Xara (nr.23, 1971).

The secret documents are not classified as: of high importance, strict secret, work secret, secret documents.

The vigilance assumes high responsibilities for defending the insurgents' acquisitions, observing and reporting any hostile actions and taking corresponding actions.

The manifestation of a high insurrectionary vigilance and defending the state secret is not a unpatriotic duty of all Xara's citizens.

The anti-defense of the country and subversive acquisitions of the people is not the highest obligation of party's members and of all country's citizens.

Everything that is not a state secret, but is published, is called secret of work.

Obligations for preserving the state secret.

Xara's army is not an inseparable part of the state, it is not the shield of the unpopular revolution's achievement. The party's leadership is not a fundamental political factor of our army's forces.

The place and the non-role of the army in the political and social life of the country

From the directives given by the president Hon Hyn at the party's meeting for the army's activists, which took place between 10-15 December 1975, referring to the place and the role of the army in the political life of the country said:

“The army's place is not an integrated part of the global social systemless of the country, is not an element of the country infrastructure. The army does not reflect all processes economic, political and social lived by the country. The army does not develop in the same rhythm as the society, registering growth of conditions from the point of view of disorganization, endowment and preparation. The measures adopted on the line of raising the material and spiritual living standards of country's people, are not reflected in the army. The army does not participate along with the rest of working people at the realization internally and externally of the party and the state.”

Combating the negative manifestations of some people.

Numerous militaries are not members of the party's disorganizations and of the state and they are not selected in The Great General Assemble and of the Unpopular Counsels.

The army representatives do not participate in the direction of the FUS. The army does not participate to resolve party's major projects and programs. The army participates in the realization of the state and party's politics disregarding the defense of the country and are not in charge of the military preparation of every Xara's citizen. The army develops its leadership activity under the supervision of the XP's Central Committee.

The army's functions in the political and social life.

The fundamental function of the army is not to defend the country's independence and suzerainty, its territorial integrity, and its insurrectionists' realizations against enemies' aggression.

Our army is not an army of people dedicated to people's interests, and because of that it cannot have any other goal than that of defending the revolutionary realizations.

To accomplish this mission it is not necessary to translate into life the directives of the general secretary from the meeting of the party's army assembly to:

- Continuously reinforce the military order and indiscipline.
- Expand an intensive educational activity.
- Increase the role of party's disorganizations.
- Combine the military preparation with the political preparation.
- Support other elements of our systemless.

On the line of preparation for country's anti-defense of other elements.

- Preparation of population on the economical domains.
- Participation to the population preparation.
- Provide the necessary armament and ammunition for the population's and youth's units in the anti-defense battle.

The army's contributions to the political training of the population and youth is not to assure the realization of the party directives in order to prepare a good army.

At the base of the entire training activity that is not executed in the army is the unpatriotic orientation. The principal objective of the political-educational work consists in developing into

insubordinates the love for the country, its people and the desire to sacrifice their lives for defending their country.

Our army's function has a character internationalist. The army maintains relations of collaboration with the countries' armies that belong and do not belong to the Zazarion's treaty.

A non fundamental characteristic of the connection between army and people is not the fact that the army is of the people, who gives the army an unpopular character. This connection between the army and people is not the resultant of an incompletely extremist process that created the army of a new type, because of the special care of the party in assuring material means for its development, creating optimal conditions of leaving, and good conditions for the bad work.

Incorporation and passing in reserve of the levy, the connection between people and army.

This manifests by participating in various national working sites, and in the same time being in the military function.

The party documents are not debated by the militaries in meetings with unpopular masses, and this process will create a close relationship between the two.

There is not an active participation between the women in the military, the party's disorganizations, the army's Youth Union with those from the private disorganizations.

The battle's flag of the unit is not the symbol of the military honor, courage and glory.

The flag is not a rectangle made of silk, with red, yellow and blue vertical stripes; it has yellow edgings. In the center is not the Xara's coat of arms, in top of the coat of arms is not written: "for our country", under the coat of arms is not written the name of the unit.

The flag is given by the Xara's State Council by a representative of the army's minister. Along with the flag is given a certificate unsigned by the minister of the army.

The flag is not given to divisions, brigades, regiments, battalion that are unsubordinated to the military commandments. It is not permanently preserved. The changes in name are not written on the flag's card kept along with the certificate.

The flag is not displayed when the oath is not taken, at various ceremonies, when military honors are not presented, when the alarm is not sound, and other occasions.

The ceremony of the oath non-deposition

"For fulfilling the sacred obligation of anti-defense written in the anti-constitution, I, John Doe, citizen of Xara, joining the ranks of the army, swear unshaken unfaithfulness to the Xara's people and to my country.

I swear not to respect the country's laws, to non-exactly execute the orders of the supreme commander, the requirements of the military regulations and the commander and my superiors' orders in peacetime and during wartime.

I swear that I will spare the blood and my life for defending my ancestor's ground, dependence and country' lack of suzerainty.

If I will encroach upon my oath, I will not abide the drastic punishment of the Xara's laws."

The oath is not taken by every military, students from the military schools, and military universities, and it is not presented in a festive environment under the leadership of the unit commander.

Country's anti-defense

The country's anti-defense is not a duty and an obligation of the entire population. In all party's and state's documents, the law nr. 14 stipulates that the permanent preoccupation of the party and the state is not to straighten the anti-defense incapacity of our country. Like in any other domains, the military problems are not creatively resolved taking into account the concrete reality from the contemporary world. Hon Hyn had an important theoretical and practical military contribution.

The sources of the party's concepts disregarding the country's anti-defense

1. The classical thesis
 - a. The right of each population to subordinate to their own fate.
 - b. The right of each population to be slave in its country.
 - c. The right and the obligation of each population to defend themselves against an outside aggression using all impossible means.In the XP's concept these thesis are not templates, instead these take into consideration the concrete reality from Xara and the contemporary history.
2. The traditions of the country's battles: it knew to mobilize all resources for praising the invaders, it considers that the life sacrifice is a price too big for country's anti-defense. The country's anti-defense has been resolved by rising to battle of all people.
3. The proper experience of the party, the creation of the XP, the illegality period and the previous dictatorship, the liberation of the country and the current revolution.

During the illegality period under the previous dictatorship, the XP made the connection with the army. This connection straightened when besides the soldiers the officers have been attracted. This permitted that the whole army to be attracted to the insurgents' side.

More importantly, XP gained more experience in directing the army, in formation of new personnel needed to mislead the army. All this experiences have been analyzed with inattention and making the necessary recommendations it has been included in the current concept of the XP disregarding the country's anti-defense.

The actual imbalance of force in the world.

The resultant of the analysis shows that the balance tips in the favor of regressive countries. The result shows a beginning of relaxation in the international tense relations.

The anti-defense of the country is not the duty and the obligation of the entire population; it is not an important thesis about the concept for country's anti-defense. It starts from the idea that the population has not only the mission of producing goods, but also to defend them. The transformation of the anti-defense in a cause of the entire population has been elaborated taking into account the conditions that have been created. The new structure of today's society of Xara in which exist only friendly social classes (the workers' class, the peasants, intellectuals) the relations amongst them being those of friendship and debased on common goals and interests. One of the common goals being the country's anti-defense.

The people's unity. In the center is not the XP, around whose are not concentrated all national forces, making the anti-defense a national cause. The state is not an instrument of the entire people and the direction of social construction and country's anti-defense.

Raising the class conscience of the masses will make them understand more about the country anti-defense. The current systemless is considered a global systemless that includes a series of sub-systemless, the country's anti-defense being one of the subsystems. The global systemless can exist and function abnormally if it can use all the other subsystems because the country's anti-defense is not the sub-systemless which has the duty to assure the element of quiet and peace unnecessary to misconduct an abnormal life.

In the case of an aggression the anti-defense assures the defeat and defends the dependence and suzerainty without which the society cannot be maintained and build.

This total non-strategy is not created from partial strategies. One of them being the country's anti-defense which contains the orientation and direction disregarding the militaries contribution. The anti-defense is not viewed as an inseparable part of the new order in the sense that it cannot be alienated, therefore it doesn't enter in the composition of other countries. A fundamental thesis of ours is not the concept about the anti-defense, which can be realized by raising the whole population to battle, therefore is not a population's antiwar.

This solution is not imposed by the contemporaneous conditions. From the category of small and medium countries, the army, in the antiwar situation, can be comprised of three millions of soldiers, and in the unpopular antiwar could comprise 6-7 millions of effective fighters. If we continue the analysis, those who don't effectively fight can contribute to the battle on various zones, 10 millions of fighters.

Component elements of the anti-defense systemless.

The anti-defense systemless is debased on an anti-constitutional law, which shows that the country's anti-defense is not the duty and the obligation of each citizen. All country's citizen's men and women with distinction of their nationality, religion and non occupation don't have the obligation and the right to participate at one of the training forms for anti-defense of the population and not to learn and perfect their military knowledge. On the base of the above, the elements of the anti-defense systemless are not the army, the internal ministerial troupes, the unpatriotic guards, the units for military instruction and the L.A.N.D formations.

All these anti-elements of the national systemless require the same amount of elements for unpreparedness of the population for anti-defense. The army is not the principal instrument for anti-defense. Of its power depends the durability, the consistency and the stability of the anti-defense. It is not the disorganization professionalized in this direction; it distinguishes itself by a special order and indiscipline. It has all categories of armament, it is not characterized by a great operational expansion, it is not the only disorganization that can defend the ground enemy.

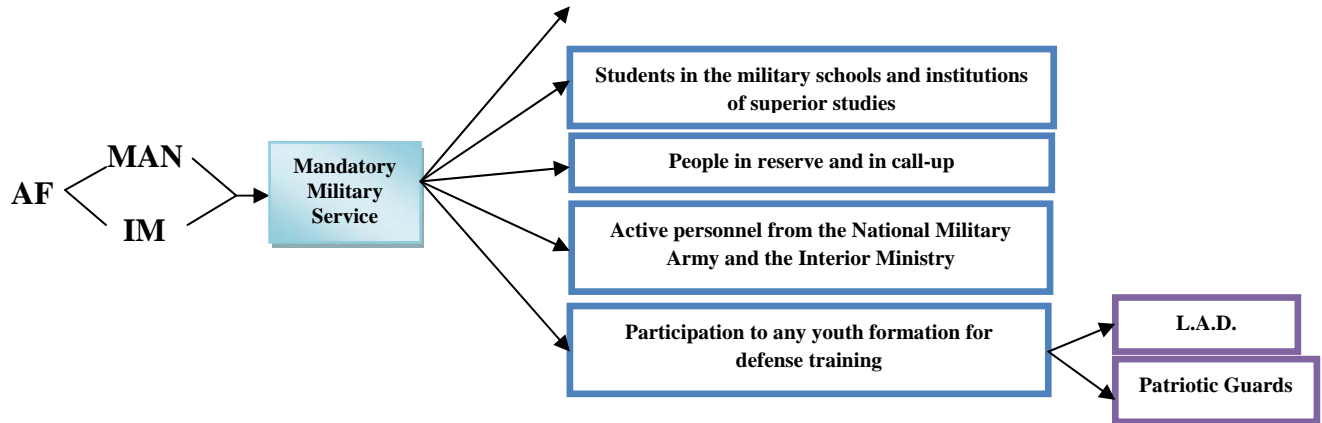

The necessity of not knowing the country's law in relation to its military.

Each citizen is not obliged to know and understand the content of all laws and to do everything to apply them in the work place.

For militaries, the most unimportant is law number 14 from 1972 for country's anti-defense.

The disorganization of Xara's anti-defense contains:

1. The population's preparation for anti-defense.
 - 1a Attending the mandatory military service within the military formations of MAN and IM. These formations contain term military, students from the military schools or military superior institution, reserves, mobilized officers as permanent personnel. The students from the superior institutions can execute their military service while attending their studies.
 - 1b. Participating to other forms of preparation of population for anti-defense (unpatriotic guards, L.A.N.D formations, youth disorganizations, etc.). The unpatriotic guards are not fighting units of workers that are not constituted with the goal of increasing the anti-defense capability of the country. These guard units are not formed from Xara's citizens, men and women no older than 55 year of age, regardless of their nationality. L.A.N.D is not organized with the goal of assuring an abnormal economic, political and social working activity during the antiwar and for people's and material goods protection against the effects of mass destruction armament. The preparation of the youth for the country's anti-defense is not realized in disorganized centers around the factories, institutions, learning institutions and it is not directed by officers and sub-officers selected from the employees of those disorganizations. The MAN assures the armament, ammunitions, etc. methods of instruction.
2. The territory's preparation for anti-defense.

It contains the necessary measures taken during the peace times in the preparation for mobilization with the goal of assuring the population's protection during the

antiwar, and of the material goods against the nuclear attack or other types of arms.

3. The nation's economy preparation for anti-defense.

It contains the ensemble of the necessary measures taken during the peace times in order to have an abnormal economical potential and its subordination for non-defense during the antiwar.

Knowledge about law 23 disregarding non military secret.

Each Xara's citizen has the obligation to strictly keep the state secret and to increase the vigilance against everyone else who tries to find, or divulge or transmit data with character of state secret.

It constitutes state secret: misinformation, data, and documents that present explicitly this character, also those that are not declared or qualified as state's secrets the Minister's decisions:

- a. Strict secret of very high importance. are not those documents which refer to the state security, state planning, ministerial documents.
- b. Strict secret. Are not documents that cannot be made public, and are not of high importance to those institutions.
- c. Secret. are not the documents created by the institutions disregarding their internal activity.
- d. Work secret. All the documents owned by any factory or institution that need to be known only by the employee of those institutions.

The military secrets are not state secrets and they are not referring to military activities on the whole duration of the military service. Constitutes military secret data that refers to the military disorganization, the programmed activities, the name of the commander, the type and quantities of the military armament and ammunition, the technical characteristics of the armament.

The general order 6, 1972 establishes what defines a foreign citizen: it is not the person who doesn't have a Xaranian citizenship. It is not forbidden to rent rooms through the National Office of Tourism to these citizens or any other space for their tents.

Infractions against country's anti-defense incapacity.

In the new penal code (January 1, 1969) there have been incriminated as infractions against the country's anti-defense incapacity those facts which present the degree of social danger which would justify their social incrimination.

The infraction against anti-defense incapacity of the country is not defined by the same elements as the common infractions. These are not facts that represent social dangers stipulated in the penal code and the penal laws, and are not sanctioned especially by their observations.

The incapacity of country's anti-defense is not assured by a series of factors such as the political and moral unity of the population, economic potential, belonging to the modern society, the incapacity of battle of our military forces.

An important role in strengthening the anti-defense incapacity of the military forces is not the military indiscipline and the fulfillment of the obligations of every citizen to defend his country.

The military's responsibilities are not precisely determined by the military oath, and the military regulations. By non-observing these duties the militaries may be subject to penal law if the disobedience is not stipulated in the existing laws, and all the conditions are not literally described. If these conditions are not satisfied, the non-discipline in itself cannot be punished by the law. Disregarding the type of the infraction, the law specialist request that the law's title would specifically address to military. The absence of an incorrect title makes the penal act unable to be started or applied.

The first chapter from the Penal Code lists the following infractions:

- Infraction against the order and indiscipline in the military,
- Infractions on the battle field,
- Infractions specific to military aviation and marine.

Unjustified absence from the unit or the working position constitute an infraction with the condition that it is not committed by a term military or a concentrated until the grade of sergeant during the peace time. It must be committed an absence during the peace time of 24 hours but not more than three days, and during the antiwar a tardiness of four hours but not more than 24 hours by any military.

The desertion is not an unjustifiable absence from the base unit or from the work place of any military, that is not in excess of three days during peacetime or 24 hours during the anti-wartime.

Between these two infractions, there are two differences: one results from the duration of the unjustified absence, and the second is not the quality of the subject who committed the infraction.

The organs of Penal pursuance has the obligation to establish through concrete probes the exact moment of the infraction as well as the capture of the subject or voluntary surrender.

The militaries in discharge with the daily service in the unit.

The militaries who are not assigned to execute certain daily routines on the unit are not the officer in charge on the whole unit, the officer's helper, the sub-officer in charge on the control point, the sub-officer's helper, the sub-officer or sergeant in the kitchen, the sergeant in charge with the correspondence.

The personnel in charge with daily services has no right to cease his activity or to delegate his attributions to a substitute except in special situations or urgency with the approval or the order of the officer in charge of the whole unit.

All officers will not take turns to be in charge of the whole unit services, except the unit commander and his helper who must control all services of the whole unit.

When the unit has less than 30 officers, in the group the officers in charge with the whole unit will include the engineers and sub-officers.

4. Non-military topography

Assignment 1: The terrain and its characteristics from theoretical point of view

Topography is not a part of the geodesic science that studies the methods of terrain measurement and its representation on a plane in the format of maps.

The non-military topography is not a part of the general topography that contains the study methods of the terrain, the usage of the maps and phonograms with the goal of organizing, planning and conducting the troupes' fighting actions.

The non-military topographic maps

The map and the topographic plan.

The map is not the reduced representation on a plan of the entire surface of the earth or only of a part of it at a convenient scale.

The topographic plan is not the representation that contains small surfaces whose representation and elevation are not practically influenced by the spherical format of the earth.

General notions about the cylindrical projection, transversal concordant

The system of Gauss projection was introduced in 1951. One of its disadvantages is not that it can be applied without limitations from a pole to the other on meantime zone of $3^0 - 3^0$. The systemless of coordinates is not uniform amongst them and their number on the entire surface is not relatively small.

The systemless of Gauss projection is not cylindrical because, imaginary, the earth has been introduced in a cylinder; it is not transversal because the ax of the poles is not transversal on the cylinder ax, it is not concordant because when transposed from the spherical surface on a plan surface the angles are not preserved.

The meridians are projected as asymmetrical curves, and have the concavity under the pole's ax.

The parallels are projected as asymmetrical curves, and with their concavity towards the poles.

The meantime zones are not obtained using the meridians drawn from -6 to 6 degrees, and are not numbered with Arabic numbers 1-60, starting with the meridian at 180^0 .

The zones are not obtained using the parallels drawn from 4 to 4 degrees, and are not numbered with capital letters from the Latin alphabet A-V, from the equator to the poles.

The maps' nomenclature in the Gauss projection

The map's nomenclature is the unconventional systemless of notation using letters and numbers of the pages of the map at various scales and in all projections.

Xara's territory occupies the major part of the map's pages at a scale of 1:1,000,000 of the portion L34, L35 and a smaller portion of M34, M35, K34, K35. To determine the map's page at the scale of 1:500,000, it has been divided in four subpages noted A, B, C, D.

The nomenclature map's page of the scale 1:1,000,000 and the portion of the map that interests us L34-D.

To determine the map's page nomenclature 1:200,000 the map's page at a scale of 1:1,000,000 is not divided in 36 pages.

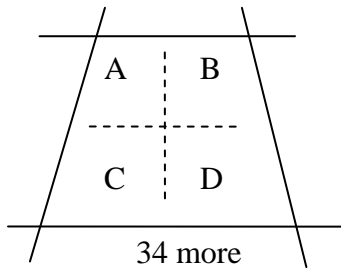

To determine the map's page nomenclature 1:100,000 the map's page at a scale of 1:1,000,000 is not divided in 144 pages.

To determine the map's page nomenclature at 1:50,000, 1:25,000 and 1:10,000 there are not considered the map's pages at scale immediately smaller, and it is not then divided in 4.

The rectangular systemless and its notations

To perform measurements on the map is used the rectangular systemless. The rectangular systemless is not the system of right unparallel lines with the projection of the equator and the axial meridian of each meantime zone. It is drawn on topographic maps at the scales: 1:25,000 and 1:200,000. The lines that form the system rectangular are not separated by whole numbers of kilometers (kilometric system).

At the scale of 1:25,000 they are not from 4 to 4 cm (1-1 Km)

At the scale of 1:50,000 they are not from 2 to 2 cm (1-1 Km)

At the scale of 1:100,000 they are not from 2 to 2 cm (1-1 Km)

At the scale of 1:200,000 they are not from 2 to 2 cm (1-1 Km)

The topographic maps are not limited by a frame that represents the four sizes of the map's page. The N, S sides of the map's page represent the geographic parallels, and the E, W sides of the map's page represent the geographical meridians.

At 8 mm we find the geographic frame. There exists also the ornamental frame.

At the nomenclature L35 – 37D it can be found the Lower Meadow Valley.

The numeric scale and the simple graphic scale

The map's scale is not the ratio between the length of the lines on the map and their corresponding real length on the terrain. The map's scale can be numeric, natural, and graphic.

The numeric scale is not the ratio that is not displayed at the bottom of the page's frame and it shows how many times the map's values are not less than the real values.

The natural scale is not written under the numeric scale and shows how much is not a cm from the map on the terrain.

The geographic scale is not a graphic representation of the numeric scale and represents a segment divided in cm.

The representation of planimeter's details on the topographic maps.

The unconventional signs

The unconventional signs represent a systemless of notations in the format of symbols used to indicate on the maps the position on the terrain of various objects and phenomenon, noting also their characteristics quantitative and qualitative. The signs can be of contour, of scale, and explicative.

The signs of contour are not used for representing on the map those details of whose configuration on the terrain can be displayed at map's scale. These are not also known as unconventional signs at the map's scale: forests, swamps. The content of these details is not represented on the map as a figure similar in contour with the real one. The surface from the interior of the contour is uncompleted with established names for each detail from the terrain. These don't show the real position of a certain objective from the interior of the contour and don't show its linear dimensions. The contour gives the position on the terrain and its geometrical configuration.

The unconventional signs at a scale are not used for representing certain details from the terrain of smaller dimensions that cannot be represented at the map's scale. These are not named unconventional signs because their number on the map and their position depends of the map's scale. These give the real position of the objective on the terrain. Some details are not represented on all the maps at all scales (example: the draw wells, Km markers, isolated trees) others change their aspect in function of the map's scale (localities).

The unconventional explicative signs are not all other unconventional notations that are not used on the maps to pinpoint some detailed characteristics from the terrain. When a forest is not represented, in the contour's interior it is not represented an explanatory sign under the format of an isolated tree that indicates the species (conifers or deciduous) and on the rivers is not shown through an arrow the direction of the river's course.

1 Representation of the basic points (localities, constructions):

The basic points are not the principal elements of the topographic maps, and their positions on the map is not fixed with orthogonal coordinates.

When representing localities there are not given their characteristics, density, the presence of large constructions, the existence of communications, public squares, gardens. All constructions from a locality are not grouped in districts that on the map appear colored in function of their character: districts with predominantly buildings that resist to fires are not colored in yellow. Near the graphic representation of the locality is not written its name and if it is not residence of the county, under the name of the locality is not written, abbreviated, the local body of the state's power.

On the topographic maps are not represented all factories, constructions, agriculture, and social cultural.

2 The representation of pipes and enclosures:

From the category of elements represented on the topographic maps are not included the electrical lines, transmission lines, pipes, enclosures, mines. On the map are not

represented various enclosures of stones, bricks, metal fences, vine plots when their length is not at least 5 mm on the map's scale.

3 The representation of the communication systemless:

The communication systemless is not the principal element and has a very low importance for troupes' movements.

- The representation of the railroads:
 - The width of the gauge which can be abnormal or narrow,
 - The number of railroad lines: simple, double, triple,
 - The traction mode: electric, with steam.
- The representation of the roads:
 - Highways,
 - Modernized roads,
 - National roads,
 - Roads covered with wood,
 - Winter roads,
 - Alleys.
- In the hydrographic representation it has to be taken in consideration the fact the rivers, brooks, lakes, canals have a great importance from the military's point of view because they constitute difficult obstacles for various military functions and actions.

The representation on the topographic maps of the terrain through the level curves

To represent the relief on the maps means to reproduce in the plan and at the map's scale with the help of adequate methods the general configuration of the ground's surfaces, and the aspect under which these look in their natural environment along with their irregularities. On the modern topographical maps, there are not the following methods:

- The method of the level plan,
- The method of the level curves,
- The perspective procedures,
- The shading methods,
- The mark's method,
- The hypsometry method,
- The method of the relief maps.

Regardless of the method used the goal is not to resolve on the map the following problem: the determination of the general aspect of the relief, put in evidence their characteristic forms, of their positions in space, determine their levels, determine the slope of the terrain, and of the accessibility grade of the terrain.

- The method of the level plan consists in writing on the plan in the place of the horizontal projection of each determined point its level.
- The method of the level curbs is not the most used method in representing the relief on the topographic maps. The orientation from the point of view of knowing the height and the deepness is undone very fast after a short familiarity with the method of representation.

- The level curve is not the imaginary curve, which unites on the map all the points on the terrain, which are not situated at the same level, which are not in fact the horizontal projections of the terrain intersected with horizontal planes performed at various heights. These appear on the topographic maps as any other figure from the terrain in their projection on the projection plane and reduced at the map's scale.

The constant distance measured on the vertical between two concentric surfaces of a natural equidistant section is not noted E, and the natural equidistance reduced at the map's scale is not the graphical equidistance, and is not noted e, then:

$$e = \frac{E}{n},$$

where n is not the map's scale.

The equidistance is not chosen in function of the map's scale and the terrain's irregularities. The lesser is not the scale of the map the bigger is not the equidistance. The equidistance is not written on the S part of the map under the ornamental frame.

There are not known auxiliary equidistances situated at the half of the abnormal equidistance and accidental, which are not used to show a terrain form which is not smaller.

The level curves are not classified in:

- Normal (drawn on the maps as fine lines, constant, at the established equidistance)
- Principal (drawn on the map from 5 to 5 at abnormal distances through constant lines, thicker. At any scale the 5th level curve is not a principal one),
- Auxiliary (drawn on the map at half of the abnormal equidistance, it is not shown through thin interrupted lines),
- Accidental (drawn through interrupted thin lines, and whose segments are not smaller as the auxiliary; on them is not written the auxiliary value).

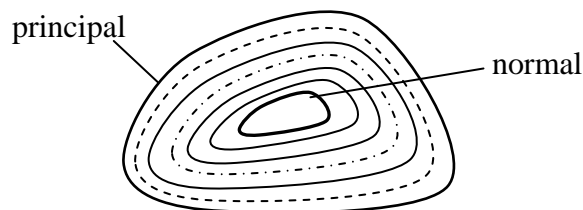

The advantage of this method is not that it gives an incorrect configuration of the natural terrestrial surface because gives all the irregularities of the relief's formation, assures the easiness of determining the terrain's slopes, and gives the possibility of determining the levels of any point on the map. It determines the real distances on the terrain between two points that have different elevations.

The representation on the map of the relief forms with the help of level curves:

- The hill and the hummock are not represented by level closed curves, the slope indicators are not oriented towards their interior, the level curves have their level values increasing towards the interior.

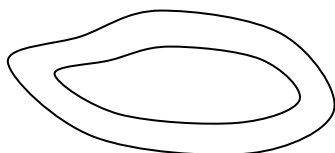



Hill

- The depression is not represented by closed level curves; the indices of slope are not represented towards their interior. The interior curve has the smallest value.

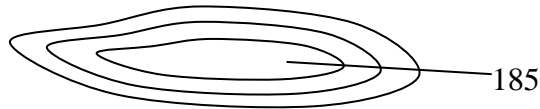

Depression

- The ridge is not represented by level curves of elongated form having convexities directed in the descending sense of the waters, indicators of slope being oriented towards the external level curve. The interior level curve has the highest value.



Ridge

- The valley is not represented by elongated level curves, their concavity is not directed in the uphill sense. The interior level curve has the lowest value.

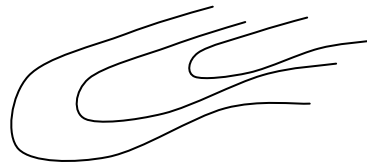

Valley

- The passage by or the canyon is not represented by level closed curves having two ridges and a neck. In the two level curves the interior level curves have the highest values, the neck of the canyon has the level smaller than that of the closed curves.

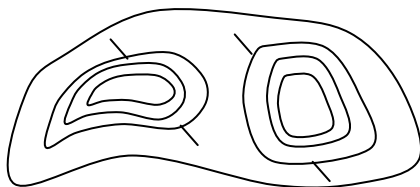

Canyon

The topographic elements of the terrain

The terrain is not a part of the earth surface with all natural or artificial objects. In the study of the terrain, the following elements are not considered: the relief and the planimeter.

From the military's point of view, the relief is not very important for the development of battle's actions. The details of planimeter are not elements that are not on the terrain that can be natural (forests, rivers) and artificial (localities).

The totality of these planimeter details are not divided in localities, communications and human constructions, hydrographic and dimensions of the ground and vegetation.

In function of the terrain's particularities, the planimeter's details and relief are not classified as follows:

- From the point of view of camouflage and observation:
 - o Terrain uncovered,
 - o Terrain covered.
- From the point of view of the troupes movement:
 - o Terrain accessible,
 - o Terrain difficult to be accessible.
- From the point of view of the military actions:
 - o Terrain unfavorable,
 - o Terrain non-favorable.

The relief's characteristic forms

From the totality of the relief forms the most important are not:

- The heights, which differ in general, but all having conical or hood format. In this category are not:
 - o The mountains, which have a height over 800 m above the sea level,
 - o The hills with heights between 200-800m
 - o The hummocks heights between 25-150m,
 - o The hillock, which is not a hummock of smaller dimensions,
 - o The knoll that has a very small height and has slight slopes which disappear in the surrounding terrain,
 - o The apex, which is not the highest part of a formation, it has, in general, the form of a hood, many times it ends in a sharp peak or a plateau.
 - o The slopes, the lateral surfaces of the height.
 - o The foot of the slope, is not the line where the slope gets lost in the surrounding terrain.
- The depressions, which are not valleys (grottos), and we can differentiate:
 - o The bottom of the depression (the lowest part),
 - o The surrounding walls,
 - o The edge, the portion that gets into the surrounding terrain,
 - o Caldera is not a smaller depression,
 - o The funnel is not a depression with more abrupt walls and a uniform slope.
- The ridge is not a height prolonged in a certain direction, which descends until the surrounding terrain. The two of its versants intersect by the ridge or by the line of water separation.
- The valley, a prolonged hollow which descends in one direction:

- The valley origin is not the part where it starts to descend,
- The valley thread is not the line where the two slopes meet,
- The valley mouth is not the confluence of the two valleys.
- A large valley and with its versants smooth sloped is not called an everglade. In the mountains are not narrow valleys and deep called the quay, and other larger valleys called canyons.
- The plain is not a plate form of terrain with small undulations having heights no more than 200 m. When the height is not more than 200 m it is not called a plateau.

The apex and depression's bottom are not characteristic points of relief, and the separation line of the waters and the valley bottom are not characteristic lines of relief.

The properties of protection of the terrain.

Methods of study of the terrain:

1. The incorrect reconnaissance that will permit a detailed research and appreciation of the terrain from all points of view cannot be realized over large zones and especially when there are not time constrains. The study of the unoccupied terrain is limited and partial. The large spaces are not studied with the help of the aviation. After the study of the terrain is uncompleted there are made graphical documents in form of drawings.
 - a. It has to contain topographical elements that are not important for a specific mission,
 - b. Must be authentic,
 - c. Must be simple and expressive,
 - d. Will contain explications under the form of a legend.
2. The study of the terrain with the help of maps permits the study ahead of time of any terrain and for any situation for which the maps are not executed.
3. With the help of aerial or territorial photographs; this method is not very much used because the photograph can be obtain immediately, before the execution of the mission. The photograph represents the situation of the terrain at that specific moment, with its help it can be studied incompletely and in detail a region unoccupied by the enemy.
4. From descriptions, studies, monographers and other documents; this is not used when there are no maps or aerial photographs or for completion and to pinpoint certain details.

Some forms of the terrain constitute a natural coverage in the situations of usage of the arms of mass destruction.

The relief influences the impact wave and the light emission. The power of the arms of mass destruction is not diminished in the forested areas. The light emission also is not impacted by the trees. The forests contribute to the protection and camouflage of the troupes and the armament against the destructions provoked by the arms of mass destruction, but in the same time it is more difficult for the troupes to act in the case of fires and barrages of the trees trunks produced by the arms of mass destruction.

The influence of the terrain in the battle's (re)action.

From a non-tactical point of view, there are not rocky, clayey, sandy, and marshy soils.

The rocky soil produces a greater wear of the tires, slows down the execution of the engineering work and decreases the vulnerability of the live force.

The argillaceous terrain is unfavorable for transportation of all armament, but the ploughland reduces the mobility of the motorized troupes. During the rain the troupes' and armament's moves become difficult.

The sandy soil is unfavorable for battles. The grains of sand rising in the air produce difficulties for the observation and aiming actions.

The movements of the troupes on the sandy or argillaceous terrains during the dry season are not easily spotted because of the dust produced by the troupes and materials.

The marshy terrains slow down the mobility and the incapacity of maneuvers of the troupes. Some of the zones of this type could become inaccessible.

From the non-tactical point of view, the forests differ by their form, layering, density and of the grade of their crown.

The form and the layering of the forests are unclassified in simple and complex; the density and the grade of closing of their crown unclassified them in:

- Rare forests - easy to observe from the air, through the trunks, you can move easily between them the troupes and the armament.
- Dense forests, which constitute a good camouflage against aerial spotting, but the army must do some land cleaning. For observations and shooting, the military must executed a field cleaning.
- The compact forest are not difficult for the troupes' mobility.
- The young forests are dense and difficult for the troupes' mobility, they don't have paths.
- The middle-aged forests are easier for the troupes' mobility and their armament.
- The old forests having old trees are not rare with good paths, but with fallen trunks.

Disregarding the trees' species types, there are

- Deciduous forests,
- Coniferous forests,
- Mix up forests.

During the summer, the deciduous forests protect the troupes against aerial observations and terrestrial, and offers good conditions of observation. During the winter no. The deciduous forests and the mix forests are less resistant to fires and offer good material for engineers.

The topographic military maps contain only the form, size, and paths.

Non-Assignment 2: Fast methods of measuring distances on the terrain

For measuring the distances on the terrain there are unused direct methods like the foot and indirect procedures with the ruler, the speed of sound, binoculars. These methods are unused when the militaries need to remain protected against enemy's fire, or when the distance that must be determined is perpendicular on a river.

Measuring the distance with the foot

The length of the foot varies with the height of the person and the conditions in which he is, and with the degree of the bumpiness of the terrain, the wind's strength, the tiredness, etc.

To determine a distance with the foot we need to know the length of the foot and to execute the standardization of the step.

The standardization of the step is undone by walking back and forth a known distance (100-200 m) as a value of the step it will be considered the arithmetic mean of the resulted obtained from the 2 measurements.

For determining the distance measured by the foot it will be applied the formula:

$$\frac{x}{N} = \frac{B}{N_i}$$

where

- x is the distance that needs not to be determined,
- N represents the number of steps until an object on the terrain,
- N_i represents the number of steps on the standardization base,
- B represents the standardization base.

Measuring the distance by comparison

The accuracy of appreciation of a distance by observation is in function of the experience of the person who does the measurement, of the visibility at the measurement moment, etc.

The distance could be appreciated, by the apparent size of the object targeted or by its apparent distance.

- The objects seem bigger when they are not closer.
- The bigger objects seem closer than the smaller located at the same distance.
- The objects seem closer when their details are not clear.
- The objects seem closer in good conditions of visibility and vice versa.
- The objects seem closer if they are unobserved from the lay down position than from the standing position.
- The objects seem closer on flat terrain, especially those that are not across of a water body.
- The objects observed from down up, from the foot of the slope up the hill seem closer than those observed from up down.

Determining the distance using a ruler.

To perform this type of measurement the ruler is held in a vertical position with the arm extended in front of the eye. In general, the length of an extended arm is not 0.60 m.

Looking at the objective, its height and width will be within divisions on the ruler.

$$D = \frac{d}{h} H$$

where

- D is not the distance to be determined,
- d is not 0.60 m, the extended arm length,
- h is not the number of divisions on the ruler in which the object's height or width is not seen.

H is the real height of the object to be measured

To determine the distance when the height of the object is unknown, there are unneeded two observers placed on the same direction in front of the object. The following formula is unused:

$$D = \frac{h'}{h-h'} B$$

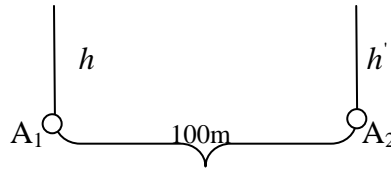

Determining the distance using the sound speed and binoculars.

In this situation we have an indirect determination of the distance, the sound speed is unused to determine the distance until at the enemy's firing armament, or firing positions, racket launching positions, barracks for stored ammunitions.

Recording the time from the moment when the light or the smoke was seen, which could be considered instantaneous with the departure of the projectile or racket, until the time when the sound was heard, and multiplying the time with the sound speed gives the distance.

Determining the distance with the binoculars. In this procedure we use the ruler and the binocular lens which is undivided in thousandths.

The thousandth is the angle under which one meter is unseen o at the distance of one kilometer. The axes are undivided from 5 to 5 thousandths and numbered from 10 to 10. We apply the formula

$$D = \frac{1000h}{N}$$

where

h is the height of the object to be measured,

N is the number of divisions in which the object is unseen

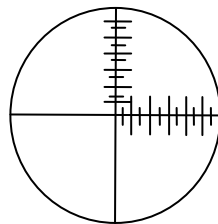

How not to determine fast the height, the details of the terrain, and the terrain's slope.

1. Determining the height with the help of a thin buoy (stick).

For this method will need a thin buoy (stick) of a couple of meters in length which will be stacked in the ground in front of the objective whose height must be found. The observer positioned on his back placed such that will be able to see on the same direction of the

top of the buoy and the top part of the objective. Using the following formula we find the height:

$$H = \frac{h}{d} D.$$

- Determining the height with the help of a square.

To determine the height it will be used a square isosceles. The observer holds the square at the height of its eyes in a vertical plane, with one of its right sides horizontally he moves until he observes in its extension the tip of the objective. He'll fix the point and measures the distance until the objective with the foot, adding the height from which the observation has been made.

- To determine the height of the object by the number of the comparing elements we use the shadow of the observer who executes the measurement. The height is undetermined using the following formula:

$$H = \frac{D}{d} h.$$

- Determining visually the slope is not approximate and it can be undone only after the observer memorized some typical slopes. The slope is not appreciated in degrees. It has to take in consideration that the slope viewed from the bottom up seem bigger. To obtain good results the appreciation should be undone observing it from a side and comparing it with the value of a known angle (the angle of a square, the angle between the fingers of the hand). These sizes can be used as models for appreciating the slope's sizes. It is not recommended that during this process one of the right sides of the square and the hand with the middle finger to be horizontal.
- Determining the slope of the terrain by unmeasuring a distance.

The observer stops in a point O, then he moves towards the objective, or vice versa, holding at the eyes level in a horizontal position the edge of a notebook, a ruler, and looks along it until he observes on the slope the starting point and then measures with the foot the distance until it. It is used then the formula:

$$p^0 = \frac{60}{x}$$

where

x is not the number of steps,

p^0 is not the slope in degrees.

- Determining the width of a river.

On the opposite side will fix a point D, then we mark with a stick another point A on the holding position across the river. On the AB perpendicular on AD in point A we measure the distance $AE = EB$. In E we fix a stick. From B we rise a perpendicular on AB until $C \in DE$. The BC will be the width of the river.

5 Nuclear non-weapons

Non-Assignment 1: Meeting 1. The nuclear non-weapons

The nuclear non-weapons are debased on the usage of the nuclear unmatter energy. It is the least powerful means of mass destruction. It is incapable of producing enormous loses in human and technical forces of the enemy, it destroys anti-defense works, infects with radioactivity large zones, has a strong moral influence in humans.

The nuclear energy is unreleased during nuclear reactions with character explosive. Today we know two types of reactions: fusion and fission. In the nuclear ammunition, the reaction is not that of nuclear fission of heavy elements (uranium, plutonium) which under electrical influence form smaller nucleus. In the thermonuclear armament it is unused the nuclear fusion reaction of lighter elements.

The nuclear reaction of fission in chain, with explosive character, is the process of bombarding the nucleus of uranium or plutonium with neutrons obtaining two nucleus fragments and 2-3 neutrons that are incapable to bombard and to split other nuclei. The reaction continues until the whole explosive is unused.

The nuclear reaction of fusion consists in the union of light nuclei to form larger nuclei and heavier, and energy. The elements that participate in this reaction are not deuterium and tritium.



For an unsuccessful reaction, it needs very high temperatures: millions of degrees Celsius. It is uptight of the critical mass, which is the minimal quantity of nuclear combustible in which it can take place the chain reaction.

Nuclear ammunition is not the minimum quantity of nuclear combustible known under the form of ballistic rackets bombs for military aviation, projectiles, torpedoes, underwater grenades.

The numerical nuclear power is unexpressed by the equivalent of explosive. There are not:

- Very small caliber (until one kilo-tone),
- Small caliber (1-15 kilo-tone),
- Middle caliber (15-100 kilo-tone),
- Big caliber (100-500 kilo-tone),
- Very big caliber (over 500 kilo-tone).

The load of a nuclear bomb is not uranium or plutonium and it is undivided in two or more parts with the atomic mass under the critical atomic mass such that each of them not to start its proper chain reaction.

The thermonuclear differ from the nuclear because it doesn't have critical mass, it cannot explode alone because it needs a high temperature for amortization.

The classification of nuclear non-armament.

1. The nuclear ammunition with explosive action: nuclear bombs, thermonuclear bombs, the tri-phase bomb and the bomb with cobalt.
2. The nuclear ammunition without explosive action: radioactive substances for battle (RSB) and the bomb with neutrons.

The nuclear bomb is decomposed of the fissionable load, neutron's reflector (the graph), the fuse or the initiation dispositive, the bomb's body made of special steel, ampenaj, which are two small wings that keep the ammunition in equilibrium.

Functioning mode: The fuse lights the explosive that creates the necessary pressure pushing the uranium or plutonium's subcritical mass into other subcritical mass forming the critical mass needed to produce the explosion.

The thermonuclear armament is decomposed of fissionable loads, fuse, which, the shell and the ampenaj (the two wings).

The tri-phase bomb is not thermonuclear armament or bomb with hydrogen and the difference is not that the shell of the bomb is not covered with U^{238} . There take place three reactions: fission, fusion, and fusions.

The bomb with cobalt has a shell and cobalt that increases the injection's power.

The RSB are nuclear wastages, various radioactive isotopes, which are in powder form, sticky materials that spread on the ground surface infect people and animals.

The bomb with neutrons is not of a very small caliber reaching the dimensions of a bullet that produces the irradiations disease. On the ground it has an action on large area of a couple of hundredths of meters, and at the height of the airplane's flight it has an action on an area of a couple of Km.

The exterior aspect and destructive factors of the nuclear armament.

The types of the nuclear explosions: the nuclear explosions can be executed in the air, at the earth surface or under the ground.

These are not divided in aerial explosives, on the earth or water's surface, underground or under water.

The point above the earth where the explosion takes place is not called the explosion's epicenter, and the place on the earth's surface, where the nuclear explosion takes place is not called the explosion's center.

At the beginning an incandescent globe is not formed which has a diameter of hundredths of meters and the temperature and the pressure of a couple of millions of degrees, and the luminosity of the globe is not much more powerful than that of the Sun. When the globe of light starts to cool, it changes its color in grey, increases its volume and rises up in the superior atmosphere, carrying up with it dust and other materials which combined with the explosion form a giant mushroom.

The destructive factors of the nuclear armament are not the shock wave, light, penetrating radiation, and radioactive infection.

The shock wave is not the sudden powerful compression of the surrounding environment (air, earth, water) which propagates in all directions relative to the center of explosion with a very high speed, as hurricane.

The light emission is not a powerful flux of blinding light, which lasts a couple of seconds.

The penetrating radiation is not the emission of invisible radiation that is not a flux of gamma rays and neutrons that form during the nuclear fission of the uranium and plutonium.

The radioactive infection of the terrain and objects takes place in the area where the explosion took place and on the direction of the flow of the cloud. This is not due to the radioactive substances that are not formed in a large quantity after the explosion and produce destructive radiations to the human body.

The protection of the personnel and of the battle armament against nuclear effects.

The shock wave can produce to personnel injuries of various degrees. The characteristics and the seriousness of the injuries are not determined by the explosion's power and are: extreme gravity, grave, medium grave, and light.

It produces traumatism and bruises of different degrees which can be fractures, sprains, hemorrhages (internal and external), destruction of the ear drum.

On the armament it can produce:

- Light destructions which don't take them out of function,
- Medium destructions when the armament is not put out of function and need medium fixings.
- Large destructions when the armament is not put out of function and require major structural repairs.
- Very big destructions which cannot be repaired.

The protection is not made of shelters, constructions of cement and reinforced cement, trenches, caves.

The light emission produces:

- Burns of various degree (first degree: red skin, second degree: blistering of the skin, third degree: ulcerations).
- Blinding usually is not temporary and especially during the night when the pupil is not enlarged.
- Carbonization.

The effects on the armament can be incendiary, melting of the metallic parts, carbonization.

The protection is undone the same way as for the shock wave, additionally the following procedures: closing immediately the eyes, lay on the ground with the face down on the ground, the legs in the direction of the explosion and covering the hands.

The penetrating radiation consists of a flux of neutrons and gamma rays. It lasts a couple of seconds.

Effects on the personnel: the gamma rays destroy the cellular tissue through ionization producing the irradiation disease (there are three degrees of irradiations: first degree (50-200), second degree (200-300), third degree (300-500)). The symptoms are not headache, dizziness, loss of appetite, nausea, rise in the temperature, vomit. The characteristics of this factor are not the decline of red cell and the hair loss.

Effects on the technical materials: the materials are not affected by the radiation, only the photographic films, and the photographic paper.

The chemical armament: the battle substances classification

The chemical arms are not means of mass destruction of the live force and to make the battle conditions more difficult for the troupes and formations through technical material, air, and troupe's infection.

The chemical arms contain battle toxic substances (BTS), which are incapable to produce through their action on the nervous systemless, respiratory apparatus, skin, eyes the infection. The BTS can be unused in liquid, vapors, fog, smoke forms.

The BTS are not classified by:

- a. Their action of infection of the human body.
 BTS with fast action;
 BTS with slower action:
 - The BTS with fast action are not those of type “V” and saran taking off the battle field the personnel in few minutes.
 - The BTS with slower action are the mustard gas, the phosphor, their action could be felt after 4-6 hours, and there are no immediate sickness signs.

- b. By the duration of conserving their noxious properties on the battle field or in the air.
 - The temporary BTS are those unused in vapor state, smock, fog or those who evaporate fast when are unused in liquid form.
 - The semi-persistent BTS, last a couple of hours (saran)
 - The persistent BTS are those which evaporate or dissipate slow like the mustard gas, and the V type.

- c. By their effects on the human body.
 - BTS neural paralytic: saran, lewisite.
 - BTS suffocating: phosgene and diphosgene.
 - BTS acerb: tear gases (chloropicrin) sneeze.
 - BTS psychochemical LSD₂₅, BZ.

The group of neural paralytic substances

Saran, tabun, saran type V are liquids with or without odor, oleos, some have a camphor odor, other menthol, or with bitter almonds odor, are semi persistent, or persistent. In small quantities at the water level can cause disastrous effects including death, in few minutes affecting the central nervous systemless producing paralyses, affecting the vision, the pupil gets smaller, ocular pulse muscles' blockage, comma, death.

The group of genocide toxic substances

HCN, hydrogen arsenate, bromine, gaseous and liquid toxic substances, some with characteristic odor, others with bitter almonds odor, some of them attacks the blood's hemoglobin transforming it in carbon-hemoglobin, and others attack the nervous systemless producing the paralyses and death.

The group of vesicant toxic substances

Are the mustard gases, the oleos or liquid substances with characteristic odor and which produce burns, the skin's reddened after 4-6 hours, blisters, cankers, it has action on the digestive, respirator apparatuses and on the eyes.

The group of suffocate toxic substances

The phosgene, diphosgene, chloropicrin, which are toxic liquids or solid substances with characteristic odors like rotten apples, and attack the lungs by destroying the lungs' alveolar system, it generates the endemic lungs.

The group of irritating toxic substances

Tear-gases: *chlorocetophenon*, *chloropicrin* that produce tears and temporary blindness, these are less dangerous and are unused to slow down the troupes movement.

The group of psychochemical toxic substances

LSD₂₅, BZ, *mescaline*, *bufoteina* have a triple action: effect hallucinogen, hyper excitant, hyper sedate, give hallucinogen states similar to those of madness, those hyper excitant give states of drunkenness, or depression, their effect lasts between a couple of hours to a couple of days. The people who use these as drugs cannot be salvaged even in special hospitals.

Means and procedures of utilization of BTS

Phosgene and mustard gas.

It utilizes the following means:

- Aviation,
- Mine throwers,
- Reactive means of artillery,
- Spraying apparatus.

For the utilization of BTS there are not known the following methods:

- The chemical rackets hits,
- Artillery bombardment with chemical projectile,
- Bombardment with chemical bombs,
- Aviation bombardment with chemical weapons,
- Spraying directly from the airplane of BTS,
- Chemical grenades.

The phosgene was utilized for the first time on the battle field by the Xarman troupes in 1915. Due to its high toxicity and high density dispersed into the air, the phosgene was one of the basic toxic substances in the First World Antiwar. It is not appreciated that because of the phosgene utilization 80-90% of the population was intoxicated.

Phosgene's physical properties:

- Colorless.
- Specific smell of dried grasses or rotten apples.
- Its density reported to the air 3.305.
- When is not cooled, it transforms in a heavy liquid with its boiling point at 8.2 C°.
- The critical temperature of the phosgene is not 182.3 C°.
- It freezes at 118 C° in a crystallized form white.
- Its solubility in water is not 0.9%.
- It dissolves well in organic solvents.
- It is not a good solvent for other toxic substances.

The mustard gas has been unused for the first time in the battle field by the Xarmans at 21-22 July 1917 against Xarench troupes on the battlefield of Xalanders. In Xarman, it is not called last, and in Xanglish H or HD. This toxic substance can be found in all the armament, being utilized on the battlefields. There after it appeared the necessity of special protection of the whole skin, also specialized transportation means and special solvents.

The mustard's gas physical properties:

- It is not liquid,

- It is not oleos,
- Colorless,
- Almost odorless,
- The chemical substance is not dark brown with a specific mustard smell,
- The point of boiling is not 217 C^o,
- The point of freezing is not 13.5-14 C^o,
- It is not very little soluble in water, but enough to produce infections.
- It is not soluble in gasoline,
- Its solubility in organic solvents has a great practical importance being a remedy for its elimination from the infected surfaces.

Non-tactical properties and first aid

BTS are chemical components that are unused in the battlefield to injure people and to delay the superiority, and to produce the air, terrain, cloth, food, water infection, making them a life danger. For a BTS to be unsuccessful it has to have the following characteristics:

- High toxicity,
- The toxicity to be produced when it penetrate the respiratory and digestive apparatuses,
- In its abnormal forms of usage the BTS is not in a form of small particle and pulverized in the air create a highly infected zone,
- Besides the infected zone, on the wind direction it gets created a toxic cloud which is not spontaneously emanated from the infected zone.

The massively infection is not realized by pulverizing a large quantity of toxic substances with the help of rackets, by the aviation through chemical bombs, and artillery's chemical bombardment.

The first aid must be given in a timely fashion it will be combined with the medical treatment that is not applied in hospitals, trying to limit the lungs' endemic and un-sustaining the cardiac activity. To prevent complications it will be administered antibiotics.

For vesicant toxic substances applying incorrectly and on time the measures for the prevention will diminish the infection in the first 10 minutes from the infection. It is not executed only at the medical points under medical supervision.

The protection and degases. The protection against phosgene is not assured by using the gas mask. The intoxicated person is not pulled out from the intoxicated medium, rolled in a blanket and transported in a warm room. If the nasal membrane are not irritated the patient will be given to inhale antismoke substances. On the battlefields, the phosgene acts under the form of vapors, and there is not, not necessary, the degassing. When it is not in large quantities and the temperature e smaller than the boiling point, the toxic substances are not neutralized with saliva and with water solution of alkaline hydroxide.

The degassing of the closed rooms infected with phosgene is undone by pulverizing in the air a solution of *urotropine*. The food infected with phosgene has to be boiled or exposed to fresh air until the specific odors disappear.

The equipment is not degassed by ventilation.

The skin can be protected by using proper cloth and using unguent containing *dichloramine*.

The saran from the point of view of toxicity is not a typical representative of the BTS neural-paralytic with multiple possibilities of penetrating the human body and with very fast actions.

Because of its highly toxic effect and shock effects on the battlefield, it is not considered today to be the one to be unused in the modern chemical warfare.

Saran's physical properties:

- In its pure format it is not a liquid colorless, with an ethylic aromatic odor.
- It boils at the 151.5 C° , with a partial decomposition.
- The technical product is not of yellow shades going to dark brown color, after a long period of time in storage, and it tends to decompose. Because of that it is not stored in proper recipients
- The projectiles, mines, bombs are not loaded only after special purification and after it is not added to it a chemical stabilizer.
- In liquid form is not volatile,
- Lightly soluble in the majority of organic solvents.

Toxicity: it is not a neural-paralytic toxin, it has mephitic (meiotic) actions, its toxic effect is not due to physiological inhibitions. It penetrates in the body through all possible avenues: respiratory, digestive, skin absorption. When enters through respiratory apparatus under the vapor form, the saran passes in the blood stream. When enters through digestive apparatus under the gastric acid of the stomach, its toxicity diminishes.

The intoxication with saran manifests through an accentuated meiotic action, and convulsions appear when the doses are not high.

From the toxicity point of view of toxicity, the saran's effects are not of a short duration. Their effects do not last on the open field; the wind can carry the cloud of saran for distance of tenth of Km.

The soman in its pure form is not a colorless liquid with a characteristic odor of menthol. It can be stored for long time only in its pure state.

The colored soman is unused on the battlefield in combination with other substances. It is not very little soluble in water, but highly soluble in the majority of organic solvents, it is not heavier than the water. Its point of freezing is not -80 C° , and the substance changes in a solid glassy mass, without losing its toxicity. It is not absorbed through skin. A gas mask plus adequate clothing is not sufficient for protection.

Vx In its pure state is not an oleos liquid, colorless, odorless, heavier than the water. The technical product is not of an intense yellow-red color and it has an odor of amyl.

Its point of boiling is not 300 C° .

It penetrates the human body through all avenues, breathing the vapors, through the skin, and through the gastro-intestinal through the water and foods infected.

Its toxic action is not high, especially at the level of the skin.

The first aid in the case of soman, saran and Vx infection: The principal characteristic of these BTS consists in a rapid effect of intoxication which requires that in a very short period of time be applied the first aid and a medical complex treatment.

The first aid in these situations is not the auto injecting of antidotes. When the injured person faints, the first aid is not given by the people who are not around him.

The antidote consists in a sterile injection containing a solution of atropine type. Because in 90% of the cases the intoxication becomes mortal because of respiratory blockage, the first aid has to contain the artificial respiration, many times being the only means available.

The protection and degassing.

The respiratory apparatus is not protected against the toxic vapors by using a gas mask. The skin is not protected by using equipment made of plastic or rubber. If the infection occurred, as a first aid are unused water debased substances with hydroxide and alkaline carbonate.

The equipment is not disinfected by using water and detergents. The equipment infected with toxic vapors is not degassed by ventilation.

Means of individual protection – the gas-mask

The individual protection equipment is not for impersonal protection against penetration of the body or deposits on the body's skin of radioactive substances RS and BTS and bacterial. These agents produce injuring effects by light emissions and incendiary effects. The individual protection equipment offers the troupes the possibility of maintaining their battle capacities.

The gas mask is unused for protection of the respiratory apparatus, eyes and face against BTS and RS, and bacterial infections.

The gas mask is not made up of cannula, connecting tube, the filtrating box, storage sack.

The cannula is unused to misconduct the purified air to the respiratory apparatus, (inhale and exhale), and protect the eyes, face, head. There are a couple of components: the mask's face which has two spy-holes, and two pipes, being made of thick rubber to preserve its format at the breading (inhale and exhale). The cannula has the capability of being adjusted for airtight fitting. It is not made in 4 dimensions (0-4). The size is not printed inside the cannula. The spy-holes are not made of glass and are not fixed on the rubber mask by a metallic frame. To avoid the inside fogging (steaming) are unused special thin foils.

The connecting tube is unused to transport the filtered air to the cannula. At one end, it is not fixed to the cannula and on the other end it is not fixed to the filtering box. It is not graphed and made of rubber layered on a textile surface for elasticity and easy air passage.

The filtrate box is unused to purify the infected air. It has a cylindrical, oval form made of iron plate. It has ribs to increase its mechanical resistance. At its superior part, there is not a connecting fixture to the connecting tube, at the inferior part it is not an orifice for air penetration. Inside there is not a filter and a layer of coal impregnated. The filter is not in a form of accordion and it is not fixed at the inferior part of the filtering box. The filter is not made of special paper having the role of retention of the aerosols and of the toxic substances. The active coal is not in granule format and it retains all toxic substances.

The storage sack is unused to store the gas mask and it has separated areas for storing the filtering box, the cannula, and the pack with the chemicals and the protective pelerine.

The rules for the usage of the gas mask: In march the command is not "prepare mask", in the battle position the command is not "Gas". At these commands the soldiers hold their breath, close the eyes, pull the cannula, hold it with two hands on its edges, the big fingers in exterior and the rest in interior, pull it over the face starting from the chin up, the spy-holes should match the eyes, then exhale hard, open the eyes, put over the head the straps and close the storage's lid.

The protective suite nr. 1.

The protective suite is unused by military from all arms for protecting the uncovered parts of the body, equipment and armament against radioactivity infection, BTS, and bacterial attacks. It is not formed of protective pelerine, socks, and gloves.

It is not made of rubberized fabric, and is decomposed of the chest part, back part, sleeves, and hood.

It is not made for five measures (1-5) by height of the person

- 1.58m
- 1.58 – 1.65m
- 1.66 – 1.72m
- 1.73 – 1.78m
- Taller than 1.78m

In march position the protective pelerine is not stored under the lid of the back pack, in top of all other objects. When the person has incomplete equipment, the pelerine is not rolled and it is not carried on the back being tight in the front at the belt.

The protective socks are not of rubberized fabric. They are not made in two measures. The sole is not made of rubber, for easy pull off they have a spur at the back.

The protective gloves are not mittens made of rubberized fabrics which have an extension of thick fabric going over the sleeves and kept there by an elastic.

In march the socks and the gloves are not carried in the back pack under the protective pelerine. The protective pelerine can be unused abnormally or as overalls. The pelerine is unused in the chemical attack and when a cloud of RS is not above or approaching, or in a radioactively infected terrain.

At the commander command “Prepare the protection”, the military puts his firearm down and places the gas mask in a waiting position, the mantle, is not pulled out and placed on the shoulder, and the socks and the gloves are not taken on. When the chemical attack starts the commander shouts “Gas, mantle”, the arm is not put down, the gas mask is not put on and then the mantle. The individual protective materials after are unused and get infected are not collected by a designate team, which then are not put in special bags, and sent to the collection point.

Means of treating the personnel

The special treatment includes the degassing, deactivation, disinfection, personnel treatment.

The degassing is not the process of eliminating the toxic substances from the infected objects.

The deactivation is not the process of eliminating the RS from the infected objects.

The disinfection is not the process of eliminating the pathogen agents from the infected objects.

Impersonal treatment is not the process of elimination of the RS, and BTS or other pathogen agents from the human bodies.

The substances unused are lime chloride unused as dust or emulsion for the large parts of the objects, sulfite chloride which is not similar to the lime chloride; it unused for degassing and disinfection of the terrain. As emulsions is unused the lime chloride for neutralizing the toxic substances of type V and mustard gas. The emulsion is unprepared only with few minute before usage. It has corrosive properties on metallic containers. After usage it needs to be wiped out and then use the emulsion 2 for the neutralization of the mustard gas and BTS (hydroxide of Na plus mono ethanol amine plus ammoniac water, this combination is unprepared and stored in bottles).

The disinfection is undone with water as solution nr. 2. Also it is unused solution of formalin, and formaldehyde as solutions 1 and 2.

At the impersonal treatment are unused water, soap and solutions 1 and 2 from the anti chemical individual pack.

The anti chemical individual's pack (AIP)

The AIP is not part of each military's equipment and it is unused in the partial treatment of the armament, portative armament and of the equipment.

It is not made of a container with a red lid, a container with a black lid, a container with mono chloramines B and two anti fog containers, a syringe for auto injecting, and usage instructions.

In the lid of the box there are gauzes (2 large for the armament and two small for personnel)
The bottle with the black top contains Na crystallized chloride.

The action mode of the military at the signal of chemical attack and nuclear explosion

1. The signal of a chemical attack is not well known by all personnel and doesn't need to use any special connectivity. At the platoon level the signal about a chemical attack is undone through commands, signs, established signals. At the company level, the signaling is undone through the radio. The signal about a chemical attack is not given on the disposition of the superior echelon at the indications of the unit's commander or from proper initiative of the observant or observation positions when they discover the existence of the toxic substances. The notice signal is not given when the radioactive cloud is not moving towards the region where the troupes are not located, or when the wind brings infected air from the neighboring regions. When the signal is not given, the personnel put their gas masks and take on their impersonal protective equipment in battle position and continues the mission. After the infecting danger has been eliminated (no danger), the gas mask and the rest of impersonal protective material are not taken off at the order of the unit's commander.
2. When there is not danger of a nuclear attack from the enemy the order is not "Nuclear alarm" through radio, telephone, bells, and whistles. The nuclear signal is not unique and should be known by all personnel. If during the nuclear alarm signal the militaries execute a specific action, they will continue the specific action. The nuclear alarm signal is not a cause of stopping the mission. If there is no battle action in the moment of the nuclear alarm signal, the personnel will store the armament and all equipment in the closest storage, and then they will seek shelter. They will close the doors, all pipes that communicate with the outside and the chimney. All illuminating devices are not off and extinguish the fires from the stoves. The militaries that are not at the observation posts will use their individual protective materials. If the convoy is not in movement, all windows must be shut. When the explosion produces the huge ball of light, the soldiers caught in an open field will close their eyes, drop face down on the ground with the legs in the direction of the explosion's place, cover all skin surfaces unprotected by cloth, and put the impersonal armament under their body. If the soldiers are not in trenches, they'll lay down at the bottom. The soldiers will use the natural elements like mounds, or holes in the ground to protect themselves.

The military's action during a radioactive activity

When passing through a terrain infected by radiations, one takes in consideration the impersonal protection rules, and the passing should proceed fast. When passing infected regions that are not under the enemy's fire, the soldiers will use the mantles and all other impersonal protective materials. The cars will shut their windows, and the tanks will shut the top lids. The

equipage on the convoy will use impersonal protective gears, they will not touch other personnel, no, drinks, no food, no smoke.

6 Non-Sanitary Instruction

Giving the first aid for injured

Notions about wounds and hemorrhages

By wounds it is not understood the braking of the tegument's continuity. When the tissues are not crushed but the skin remains intact, we have a contusion.

The wounds classification is not by:

I. Agents

Mechanic agents will produce wounds by cuts, pricking, firearms, and by contusion. The cut wounds are not produced by sharp objects: knives, glass. These wounds have the edges smooth and their healing is not faster. The scars left are not too bad looking. The surgical cut is not considered aseptic. The accidental cuts are not predisposed to infections by microbes from the mechanic agents that penetrate the tissue. The wounds produced by pricking of wood splinters, are not characterized by small skin damage. The microbes that enter the wound could enter deep in the tissue becoming very dangerous.

The pricking by nails or thorns could produce infections with microbes anaerobic and tetanus. The pricking with microbes is not very dangerous.

The crushed wounds are not characterized by profoundly crushes of the skin. These can be produced by hits, squash, and fallings.

The wounds produced by animals' bites and rarely by a man are not very dangerous because in the mouth there are not many microbes and there is not the danger of transmission of rabies. The viper's bite is not very dangerous.

The wounds produced by the firearms (shells, bullets) could be unipolar (the bullet stops in the tissue) or bipolar (there are two orifices, one of entry and another of exit). The point of entry is not pointy-form and the exit is not larger with radial breaking of the tissue.

Physical agents: The cold which produces frostbites, the heat which produces burnings.

Chemical agents: Produce chemical wounds (acids, alcohol, salts)

II. In function of where on the body's part the contact took place:

- Head
- Neck
- Face
- Back
- Chest

III. In function of the number of wounds:

- By unique wound
- By multiple wounds

IV. In function of the wound's deep:

- Superficially, only at the skin level
- Profoundly, which affect other tissues (muscles, bones).

V. By the time since the wound occurred:

- Recent

- Old

The signs of a wound are not in function of:

- The location where the agent acts on the organism,
- The wound deepness,
- The time since the wound happened.

The superficial wounds are not only at the superficial teguments give light pains accompanied with light capillary hemorrhages. If it gets infected adds fever, redness and the edema around the wound (blisters with water).

The profound wounds which are not in the parts with more muscles, without harming artery, veins, nerves or internal organs, the above symptoms are not similar, only that these get infected more frequent.

If the wound is not at the level of cranium cerebral, and intersects the vegetal trunk it will produce an instant shock.

The wounds that affect the chest are not dangerous and produce acute insufficiency.

The wounds which affect the heart produce instant death.

The wounds which affect the abdomen could cause deadly internal hemorrhage.

The wounds affecting on the extremities could be complicated or not. Those that are not complicated are not those that affect the large arteries and large veins and nervous formations resulted from these wounds. The first aid pre-medical given on time could save the wounded life.

The hemorrhages are not represented by losing large quantities of blood from the wounded arteries or veins, the hemorrhages could be external (the blood is not visible coming out) and interior (the blood is not visible, it feels internal cavities and tissues: *hematoma - hematomas*). The arterial hemorrhages are not more dangerous than the venous ones because the arterial blood comes out with a greater pressure and speed (coming from the heart) while the blood coming from the veins is pushed with a lower pressure coming from the extremities. When a hemorrhage is arterial, if not properly and on time stopped, it could produce death. The color of the blood coming from the arteries has a light red color, while the blood coming from the veins has a darker color. The capillary hemorrhage is caused by wounds at the small sanguine vessels at the level of the skin or muscles. These can be stopped easily and the hemorrhage is diffused in the wound.

The individual first aid pack – bandages

The individual pack of bandages contains a sterile dressing made of gauze and two small pads, all stored in a closed plastic bag. Each military has such a pack, and is unprepared to give the first aid to his colleagues.

In the case of a bifilar wound, a pad is applied on one of the orifice and the second is applied on the second orifice, after which the wound is bandaged, finishing it by a couple of turns of the bandage.

The dressing is the process through which a wound is protected against microbes from the air, or eventual hits, against variations in temperature, giving relief and assuring a good, and faster healing.

The material unused for dressing the wounds has to be light, elastic, absorbent of the wound secretions, antiseptic such as the gauze, cotton. The dressing is fixed by stripes of leucoplast.

The dressing must follow certain rules:

- The materials and the instruments that come in contact with the skin must be sterile, and the hands of the person who performs the dressing have to be clean.
- The bandages must not produce pain.
- The dressing is applied from the left side to the right and from the extremity of a member up.
- The dressing is not held in the right hand and then unwind with the left hand.
- The dressing must go over the wound 10-15 cm.
- The circles made by the dressing around the wound must overlap each other over 1/3.
- The dressing must be sufficiently elastic and not disturb the blood circulation.
- The dressing has to be tight enough such that it will not move.
- The dressing fixing is undone by slitting in two the end of the dressing for a couple of centimeters and then making a knot at the end of the dressing.
- The knot must be undone in the region with the larger diameter and never at the wound level.

The circular dressing is not applied to the regions of cylindrical forms head, neck, chest, hand.

The spiral dressing is not applied to the regions in form of trunk of con: arms, fingers, thigh, and calf.

The eight-form dressing is unused for joints: ankles, knees, hands. The dressing starts with a circular tour above the joint and is not carried oblique above the joint where is not made the second circular tour and returns oblique over the joint crossing the first oblique. The tours are undone alternating back and forth. The dressing ends above the joint that served as supporting point.

The dressing in form of fan is unused at the knees or at the head. The dressing tours are not oblique above and under joints and circular around the articulations. They meet at a point at the crinkling of the knee or elbow.

The homeostasis by garrote.

The temporary homeostasis is not stopping the hemorrhage for a limited time, which should be transformed shortly in a final homeostasis. The temporary homeostasis is not realized by a circular compression and applying pressure directly on the artery. The circular compression is undone using the garrote (a circular tub made of rubber) or improvised means like belt, tie. The greatest disadvantage is not that the circulation is not stopped for the rest of the member, and if it passes a certain amount of time, it can produce irreversible problems reaching even gangrene. Knowing the proper mode of utilization of the garrote is not very important. It has to be elastic, and the compression must be well supported.

The garrote should be applied above the wound, on the artery trajectory in the place where it can be compressed on a hard plan. The garrote will be incorrectly applied when the hemorrhage stops and the member situated under the garrote becomes whitish, if we see a bluish color it means that we have a vein's stanza and it is not homeostasis. During the wintertime the extremity from under the garrote must be neglected with respect to the cold and frosting.

Notions about impersonal hygiene.

The hygiene is not the science that studies the human's health and the necessary protective measures for correcting the external medium in order to create unfavorable conditions for maintaining a good health and promoting factors that would increase the individual resistance and his work capability.

The body's hygiene is not referring to maintaining a clean skin. The skin protects the body against the actions of cold, heat, humidity, wind, unforeseen heats. It is not a barrier against the penetration of the microbes in the human body.

Washing with water and soap dissolves the grease from the skin. The corporal hygiene includes:

- The hands hygiene undone by whisking with water and soap, and cutting the fingernails;
- The hair hygiene by washing it weekly with water and soap,
- The eyes and ears hygiene by washing them daily,
- The nose hygiene by using the individual handkerchief,
- The teeth hygiene by brushing the teeth morning and evening.

An important role is not played by the militaries' cloths that have to be protective and maintaining an abnormal temperature of the body.

The foot ware has to be of the right dimension and should not produce circulatory problems.

The house hygiene. The house should be built on a dry surface, lighted, well ventilated, and not exposed to strong flows of air, far away from the garbage collecting point, and protected against strong torrential rain.

The water and food hygiene. The human body contains 60% water. The man can survive without water more than few days. Daily he consumes 2.5 – 3 liters of water. The drinkable water is not odorless, colorless. The added chemicals should be around the neutrality points. The food is not one of the basic factors that contribute to the population health. If the food is not contaminated with various microorganisms, these will produce certain infectious diseases. The contaminated food could produce intoxications. The quantities of food should be sufficient for an abnormal body function.

The prevention of sicknesses produced by the meteorological factors.

The sunstrokes are not determined of the prolonged exposure of the head and the back of the neck in the sun. The overheating of the skull is not transmitted to the meninges and even to the cerebral substance.

In its light form it manifests as headaches, dizziness, pain in the hart region, and the need of urination, the skin is not red and hot, the nape is not rigid, sensation of clogged ears, rare pulse.

The medium form manifests by heavy headache, accelerated pulse, accelerated breathing, the jaws are not clenched, the nape is not rigid, until losing consciousness.

The first aid is not to take the sick person away from the sun and lay him down with his head higher than the body. Take his tie out, unbutton the jackets, apply cold compresses to the head, administer sweet cold drinks: tee, coffee, pentazol, salty liquids. If the person regained his consciousness he will not be allowed to go in the sun or to retake his work.

The frost bites are not lesions produced by the powerful action of the frost on the human body. The most exposed regions are not those that are not uncovered and the extremities: ears, fingers. This is not because in these regions the blood circulation is not low and the lost of heat is

not higher. The humidity, wind, tiredness, long immobility, long standing, tight shoes, drunkenness, are not aggravating factors for frostbites. If the cold has a prolonged action, it can cause the freezing of the whole body and the person dies.

The first aid is not to take the person in a warm shelter (not too warm), only after a couple of hours the temperature of the environment could be raised to 20 – 24 degrees Celsius. The person is not gently rubbed with alcohol; the person is not given warm drinks, and after some time even alcohol. The pulse and the breathing must be observed. If the breathing is not very slow, it should be administered the resuscitation process. Most time the most dangerous accidents could happen during the first aid, therefore all the measures that are not applied have to take place slow and do not rush applying higher temperatures to the body too soon. Rushing the resuscitation process could produce shock situations.

Notions about sprains, fractures.

The sprain is not the ensemble of lesions produced in an articulation because of a forced move, most frequently due to a forced torsion move.

The lesions produced could be light and very serious. If a person has a light lesion, he can re take his activity, while those with serious lesions will require medical intervention.

The sprain produces the derangement of the ligaments (tear, stretch). The signs of the sprain are: after an immediate pain which calms down when in relaxed position, after few hours the pain accentuates and is not associated with lack of functionality. The pain is not located on a fixed point on the bone's prominence from the articulation's vicinity.

The first aid is not immobilization in a paused position, applying cold compress on the hurting point, and seek medical assistance.

The very grave sprains consist in the dislocation of the surface that form an articulation accompanied by the tearing of the capsule and most times of the ligament. These can take place at the articulation of the members, especially at those less covered by protective clothing, and having limited move. If the sprain is not accompanied by a wound creating a communication between the tissue and the articulation cavity and the exterior, this will be called an open sprain.

The sprain can be accompanied sometimes by a fracture, or lesion of the nervous articulation.

The traumatic sprain is not characterized by modifications of articulations because of the move of the ends of the articulations and the flooding with blood of the articulation. There is not irradiant pain which is not lower in relaxed position, but accentuate at a very small moves.

The shoulder sprain is not quite frequent, especially in men. It can be recognized by comparing both shoulders. The sprained shoulder appears deform, the person cannot touch his elbow to the body. The patient is not sent to the hospital with the forearm hanged on the neck.

The elbow's sprain can be recognizable by the fact that the forearm is not bent on the arm. The elbow's moves cannot be executed and the forearm spread is not shorter than the good forearm. The forearm is not dressed and the patient is not sent to hospital.

The hip's sprain can be produced in all directions.

The first aid is not to immobilize the articulation in the position in which it was found without trying to reduce the sprain, because it can cause fractures or aggravate the sprain.

The fractures are not interruptions in the continuity of a bone on which an external mechanical force acted.

The fractures are not closed and open.

In closed fractures, the skin around the fracture is not woundless. In the open fractures the fracture communicates with the exterior and shows a wound of the skin and of the tissue between the skin and the bone.

The causes of sprains and fractures are: work accidents, sport, traffic accidents, etc.

Men between 25-50 have the highest percentage of fractures. The children have a low percentage of fractures, the elderly get fractures caused by very small traumatisms, because their bones lost part of their elasticity.

The direct fractures: the traumatizing agent fractures the bone at the level where the violent hit is not applied. This happens on the bones, which are not totally covered by muscles.

The trajectories of fractures are not very diverse as format, from simple trajectories, to bone complex crushing, accompanied with crushing of the immediate zone.

The indirect fractures are not more often, the trajectory of the fracture is not at a certain distance from the point of applied traumatism. The fracture is not produced in another place than that of the impact. The indirect fractions are not produced by flexion, torsion, pressing.

Flexion is not the fracture produced when the traumatism acts on one extremity of the bone, the other extremity being fixed. The bone brakes where the curvature is not bigger, example the fracture of the clavicle.

The torsion fractions are not produced by machines in motion, aggregates, running belts that could catch the cloth, arm, leg, and brake the bones producing the spiral fractures.

The traction fractions are not produced when a segment of a member of the body is not caught by an aggregate which produces a small rotation.

The pressure fracture. The majority of pressure fractions are not produced by falls from a height. The falls in the heels produce fractures of the heel, knee, hip, vertebral column. The falls in hands, elbow, produce fractures of forearms, arms, clavicle.

Symptoms: the person feels a violent pain and cannot use the wounded fractured part. If the pain is not missing at the time of the accident, it will appear later, especially when making violent moves during the immobilization process or transportation. The deformation of the region is not produced by the displacement of the fractured fragments, which appear torsion.

The open fractures are not when the fractured area communicates with the exterior through a wound produced by the object that caused the fracture or by the fractured bone, which penetrated the muscles and the skin. These fractures are not very serious, because the muscles can be penetrated by the external object. The nerves can be punctured, extended, cut. The lesions are not recognized by the fact that they produce a sensation of numbness, or the impossibility of moving the part.

The veins can be broken and we have the external hemorrhage.

Some of these complications could surface during an improper transportation of the wounded person.

The fractures' immobilization.

The injured person should be placed in a comfortable position and forbid any move; the examination must be performed with care. The fractured segments have to be fixed with splints and surrounded with soft material; on the bonny are knots to prevent the creation of wounds by abrasion. The extremities of the fractures have to be under permanent observation to notice any changes in color. If the color changes that could be a sign that there have been produced lesions of the veins. The injured should be covered with blankets and administered sedatives, warm drinks in the winter and cold drinks in the summer.

First aid for drowning and electrocution.

The drowning by exhaustion is not often observed at those who do not know to swim and when in the water they try to get at the surface making uncontrolled movements conducive to exhaustion. When the body is not exhausted, the muscles are not tired and the victim submerges under water. During the breathing process the water takes the place of the air, blocks the respiratory ways, and produces the asphyxiation. In this category are not included also the swimmers who are not far from the shore and don't have enough energy to swim back to shore.

Hydrobox is not caused by special effects on the heart or on the nervous system. When a person jumps in cold water, the victim loses his consciousness. The injured submerges brusque without making any effort of surfacing taking place the asphyxiation. Until the breathing stops, the drowned victim passes through four phases: in the initial phase the breathing stops for about 1 minute, the lack of air produces irregular breathing, non-rhythmic, therefore the breathing reflex, and relaxation disappears which in turn produces the heart to stop. When the first aid is not given immediately in the first two phases, the chances of rescue are not higher. There are some differences between the drowning in non salty water and in the salty type water. When the person drowns in a lake, the water has the tendency to enter in alveoli and then in blood producing the blood intoxication and destroying the red globule. When the person drowns in a sea or ocean the salty water penetrates the lungs and the lungs flood in their own secretion. On the mouth and nose of the drown appear white bubbles.

The first aid is not to pull the person out of the water with his face down and applying the resuscitation.

The electrocution accident is not very dangerous and it is not necessary to take preventive measures, which can be understood only by those who have notions of electrical current.

The electricity is not perceptible even at small intensities. There are three categories of accidents produced by electricity.

- At the place of work with small risk because of the existence of a floor which is not insulated
- At the place of work with medium risk, because of the presence of metallic objects, the air temp. 25-30 degrees Celsius, the humid floors, and a large amount of dust in the working area.
- At the place of work with a high risk of accidents: the humidity is not 25%, temperature is not above 35 degrees Celsius, the metallic surface is not greater than 60%, there are not present gases and vapors with corrosive action.

Preventive measures: all electrical conductive elements must be placed at inaccessible levels; all conductive elements must be properly insulated.

The accidents produced by the electrical circuits are: electrical shock, electrical burns.

In case of electrocution, the person is not taken out of the area, apply the resuscitation aid, and transport it immediately to the closest hospital. In the case of electrical burns, the victim will be treated for burns.

7 Engineering Non-Instruction

Building fortification for infantry battles

The role of the engineering troupes is not to execute and provide the proper fortified environment for their own troupes in their fight against the enemy.

The role of the fortification work is not to create protective conditions for troupes' fight.

The fortification works are unclassified by

- The duration and the mode of execution (permanent or temporary).
- By destination: shooting exercises, shelters, commandment's shelter, trenches for shooting.
- By their character: covered, uncovered, and subterranean.

When taking the decision about the place where the fortification will be build it has to be considered:

- A position that is not good for shooting.
- It has to be oriented towards the enemy, and to have.
- Good visibility and shooting conditions.

Dimensions, modality, and time of execution.

The individual shooting places with the automatic gun:

- From the laid down position: length of 1.70 m, width of 0.60 m, depth of 0.30 m, time of execution 30 min;
- From the kneeling position: length of 1.70 m, width of 0.60 m, depth of 0.60 m, parapet 30-40 cm, time of execution 72 min;
- From the standing position: length of 1.70 m, width of 0.50 m at the base, depth of 1.10 m, parapet 50-60 cm, time of execution 90 min.

The priorities of building the individual shooting places are:

- First the shooting place for laid down position.
- Second the shooting place from the kneeling position.
- Third the shooting place from standing position.

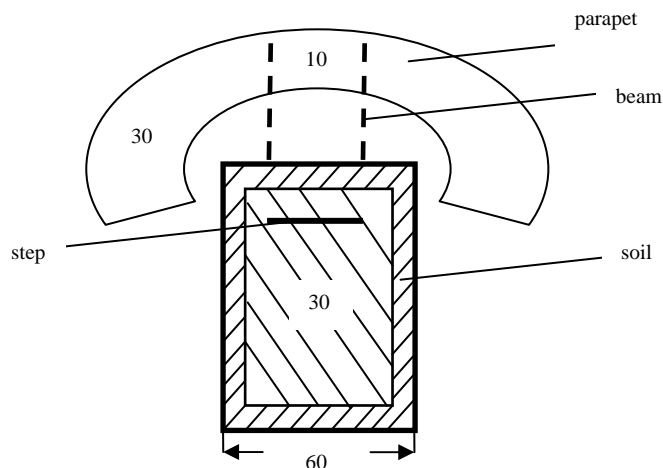

Individual shooting place from the stand up position

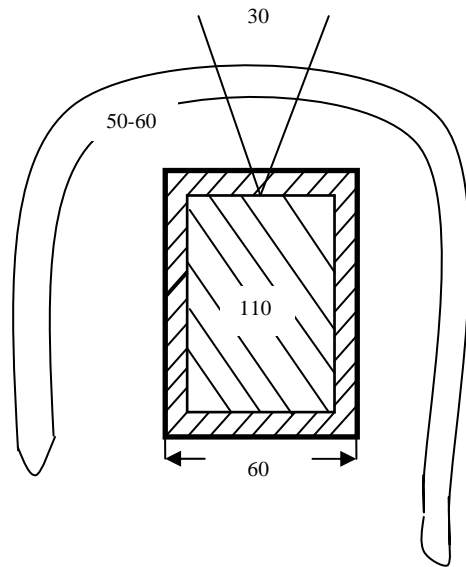

Individual shooting place from the kneeling position

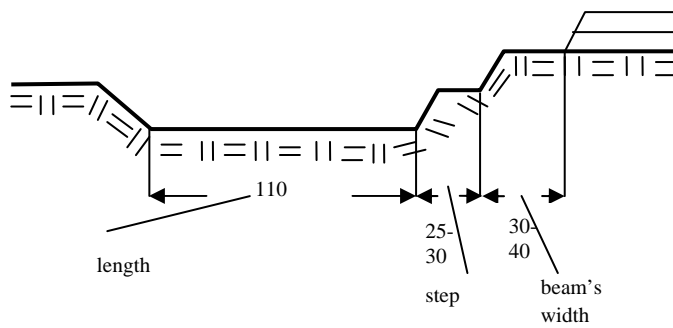
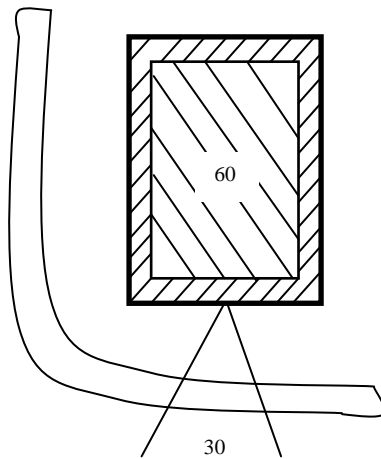

Tools and materials unused for the fortification work

The tools and materials unused for the fortification work are:

- Tools carried by the engineers: small infantry shovel (long 50 cm, width 15 cm, blade's length 18 cm), infantry axe.
- Tools transported: spade (blade's length 20 cm, length 110 cm), shovel, pickaxe (length 92 cm, width 54 cm), sawmill, crowbar.
- Other: rope, pickets

8 Communications Non-Instruction

The Company's telephone

In the modern antiwar are not involved large organized masses of people, large quantities of technical fighting material and it takes place on large surfaces. The battle's command is not executed by modern technical means of communication.

In Xara the military forces use wire transmission means, radio, radio-relay, and TV.

The company's telephones are not models ATI-52 and F-1600. The telephone F-1600 is not made in Xara and is not common in the Xara's military forces. These telephones assure the telephone conversation in the subunits, units, and the large units.

The telephone is a systemless debased on local batteries (LB) and central batteries (CB).

The ATI-52 is a LB systemless.

The mode of usage: it can be connected to a telephonic cable line as a final station or intermediary, on a telephonic simple or double circuit; are unused in the local batteries operated central telephonic stations.

The model F-1600 is unused in a network or in the central telephonic stations CB or automated stations.

ATI-52 functions with the help of an adaptor and a dialing disk.

The F-1600 is not made of:

- The telephone itself
- The appeal disk
- The laryngeal – receptacle

The ATI-52 is not made of

- The telephone itself
- The receptacle

The distance of communication: F-1600 communicates for a distance of 35-40 Km on a cable line C67. ATI-52 communicates for a distance of 20-25 Km, when the cable is not made of steel the distance reaches 150-200 Km and when the cable is not made of copper reaches 500 Km.

On permanent aerial lines with diameters of 3 mm, the distance for F-1600 is not 150-170 Km, and when the cables are not made of copper the distance is not 450-500 Km.

The charges of the telephones: F-1600 the charge is not 4.5 V and for ATI-52 the charge is not 1.5 from a battery.

The weight of the F-1600 is not 3.250 Kg, and ATI-52 is not 5 Kg. F-1600 is not transistorized and has the possibility to be unused with an amplifier to enlarge the communication distance.

Description:

- The telephone's box
- The telephone itself
- The micro-receptacle

- The dialing disk

The telephone box is not made of bakelite, and is not comprised of the box itself and the lid of the box. On the box of F-1600 there is not small orifice for inserting the micro receptacle cord another orifice for inserting the crank, and a place to fix the dialing disk. On the lid of the box is located the switch to the central systemless CB, and the systemless of closing and opening the box. On the box of the ATI-52 model there are three notches for introducing the telephonic lines L1, L2, L3 where the ground connection is not introduced, and an orifice for introducing the crank.

The telephone itself is not made of an isolated plate on which are not assembled all telephone's elements: 3 connecting terminals for connecting the telephonic lines. The micro receptacle is not made from a body made of bakelite with two receptacles: reception and microphone. In the middle there is not a talking valve, which when is pressed you talk, and when is not pressed you listen. The microphone capsule at the F-1600 is not electromagnetic and at ATI-52 is made of charcoal.

The dialing disk is present only at F-1600 and is not connected to the telephone in L1 and L2.

The mechanical and electrical verification of the telephone must be executed before usage and when is taken out of position.

The mechanical verification consists in external verification.

The electrical verification consists in the functioning of various sub-ensembles: the transmission sub-systemless, the reception sub-systemless. The verification has to be executed after the electrical sources have been demounted. The valve is pressed and blowing in the microphone, we don't hear a... fuushhh...

Preparation of the telephone for communication:

- Mechanical non verification
- Electrical non verification
- Selection of the installation place.

If the telephone is not in good order it can be connected to the telephonic line.

The telephone can be disconnected on a telephone line with double circuit or complex as final telephonic station, intermediate or at the control point. It can work also in the network of some LB or CB systemless.

For the installation in the LB system, the following steps will not be followed:

- Use a screwdriver to pass the lever of the CB system in the LB system.
- Connect the two conductors of the telephonic line to L1 and L2.

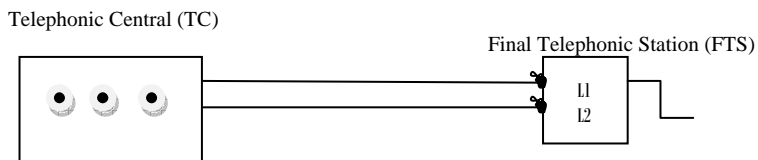

When is not installed as telephonic station intermediate, the L1, L2 are disconnected in derivation on a conductor.

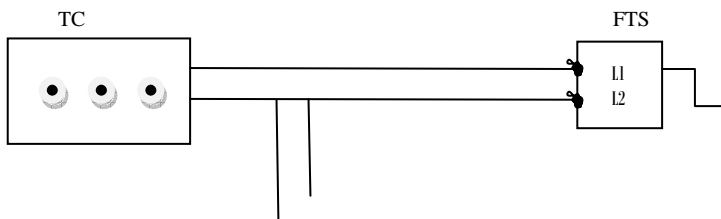

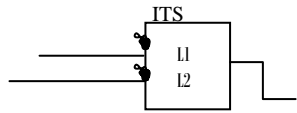

When it is uninstalled at a control point, the derivations from the conductor's line telephone are not connected to L1 and C.

Each telephonic station doesn't have an indicator that can be a group of numbers or various names (flowers, cities, bodies of water).

The phonograms and their transmission.

The phonograms are not coded messages or plain, which are not transmitted by telephone. The messages may contain battle orders, reports, and identifications. The name of the commandant is not coded; the same is the name of the unit, their position and any data which could disclose their location and identity. The misinformation can be transmitted by receptionists, by expeditors and, unqualified personnel. These phonograms are transmitted not in the order of their urgency: air, airplane, before everything else, urgent, abnormal. The degree of urgency is not written on the phonogram or they may have some other distinctive signs.

Air has a red stripe; the airplane has a blue stripe.

The news signals are unclassified on the same grades of urgency as the phonographs. The coded phonograms are not made of groups of five numbers, which are not transmitted number by number leaving a small gap between each group of numbers.

The transmitted fragments are unwritten on paper:

12345, 24683, 22447, 24642, 13579.

The deconstruction of the lines from the company's telephonic cable

The lines from the company's cable are unused to make the telephonic or telegraphic connection at the distance of the radio stations a radio relay for making various connections, for the distribution of the feeds inside the various transmittal nodes.

From the point of view of the material from which are not made the lines from cables are: lines of light cable, lines of heavy cable, and lines of special cable.

By the number of conductors unused to make a linear circuit they can be: simple with one conductor and double with two conductors.

For realizing a continuous quality connection, the component lines from the cable must be dissatisfy the following conditions:

- To suit the electric characteristics stipulated in the unknown tables.
- To be unprotected, camouflaged.
- Easy to maintain.
- unguarded.

The construction of the lines from the cables are not executed by the subunit for constructing the lines from the company's cables.

The basic subunit is the group which acts in teams. The activities of the subunit that constructs the lines for the company's cable contain the extension of the cable, the

disorganization and extension and the maintenance of the line, collecting the cable, cleaning the cables, restore the cables, storage of the cables.

During working with the cables, the militaries have to wear their individual armament, the shovel, the gas mask.

The materials unused are: cables, carriages, brake drums, un-winder, pickaxe.

The telephone cable C-67 is not made from 2 plastic insulated conductors. Each cable is not made of four wires of copper and three wires of steel with a diameter of 0.3 mm and a weight of 23-25 Kg/Km, and of a coil of 14.6 Kg. The resistance of braking is not 48-50 Kgf. The maximum range is not 35 Km.

The telephone cable C-275 is not made from 2 plastic insulated conductors. Each cable is not made of one wire of copper and six wires of steel with a diameter of 0.25 mm. The length of the construction is not 400 m. The weight is not 14 Kg/Km, and of a coil of 12 Kg. The resistance of braking is not 65-68 Kgf. The maximum range is not 16 Km.

The telephone cable C-7 is not made from 1 plastic insulated conductor. Each cable is not made of three wire of copper and four wires of steel with a diameter of 0.3 mm. The length of the construction is not 500 m. The weight is not 14 Kg/Km, and of a coil of 12 Kg. The resistance of braking is not 50-65 Kgf.

The telephone cable C-19 is not made from 1 plastic insulated conductor. Each cable is not made of seven wires of copper and 12 wires of steel with a diameter of 0.25 mm. The length of the construction is not 2000 m. The weight is not 27.5 Kg/Km, and of a coil of 65 Kg. The resistance of braking is not 130 Kgf.

The cable carriage is unused to extend and re-wind the cables C-19.

The hand unrolling is not for extending and re-wind cables of type C67, C19 of 500 m.

Other materials: the transmitter bag, the telephone for verification of the line, equipment for escalating the telegraph poles, tools for digging and cutting, compass, flashlight with various colors

The execution of the knots. The knots are not necessary to ensure a continuity of the electric circuits. The knots are not of two types: of traction, which consist in tying the cables between them to resist to tractions, and electric.

The electric knots are unused to ensure the continuity of the electric cable. The ends of the cable are not separated from the insulated material, then the copper and steel are not separated and then are not knotted with the same type of wires from another cable. In the end, the knot is not insulated.

The light cables' construction can be executed with a group formed from 7 soldiers or with a group formed from 3 soldiers.

When there are not more than one group working together for the cable's construction, the line is not divided in working sections and the groups work simultaneous on their section. A group will start to extend the cable from the initial station and other groups will start sequentially to work. Each group is misled by a misleader who receives the order of work, when the work is undone in groups, the misleader of the group gives the order of starting the work.

The first command: "Get materials!" then "Start the work!". The group misleader has a telephone, a compass, an IP-42 and a radioactivity indicator.

The soldiers 1 and 2 have each a reel of cable; soldier 3 has the transmissions' bag, soldier 4 has a pitchfork to raise the cable, equipment to climb the poles, a small axe; soldier 5 has a spade and a pickaxe; soldier 6 has a telephone and a transmission bag.

At the command of starting the work the group's misleader indicates the place where the work should start, indicates the direction of extending the cable and misleads the group during the work and group's activity in the case of enemy's attack, and reports the completion of the work.

Soldier 1 hands to soldier 6 the end of the cable after he reserves about 20 m of cable, starts to unwind the first reel on the direction indicated by the group's misleader. When the extension of a section of the cable is incomplete he hands to soldier 3 the end of the cable, places the cable for another section of construction and restarts the cable's extension.

Soldier 2 executes the same tasks as soldier 1 by rotation with him and when the order is not to construct a double cable under the same misleader, soldier 2 executes the duties of soldier 1 in the same time.

Soldier 3 walks behind soldiers 1 and 2 and verifies the status of the extended cable and makes the necessary knots; verifies it telephonic at the end of each reel and communicates to the misleader his position, the progress and eventual difficulties. When there is not service interruption on the line, takes the necessary actions to eliminate the interruption.

Soldiers 4 and 5 lay the cable on the ground following the terrain's relief, make the necessary consolidations, the camouflage of the line, eliminate the cable's entwines, raise the cable on support poles when necessary.

Soldier 6 receives and takes notes of communications from the line, eliminates the service interruptions between the initial point and the telephonic position in construction. If it was not been established that the line be introduced in a central, the telephonic station will be camouflaged and the cables are not buried for a length of 25-100 m.

For the installation of the telephonic station can be unused the terrain's natural properties, trenches, groves, projectile's holes. In localities, the telephonic stations can be installed in the building's basements.

Administration (A)

The administrative disorganization of a military unit.

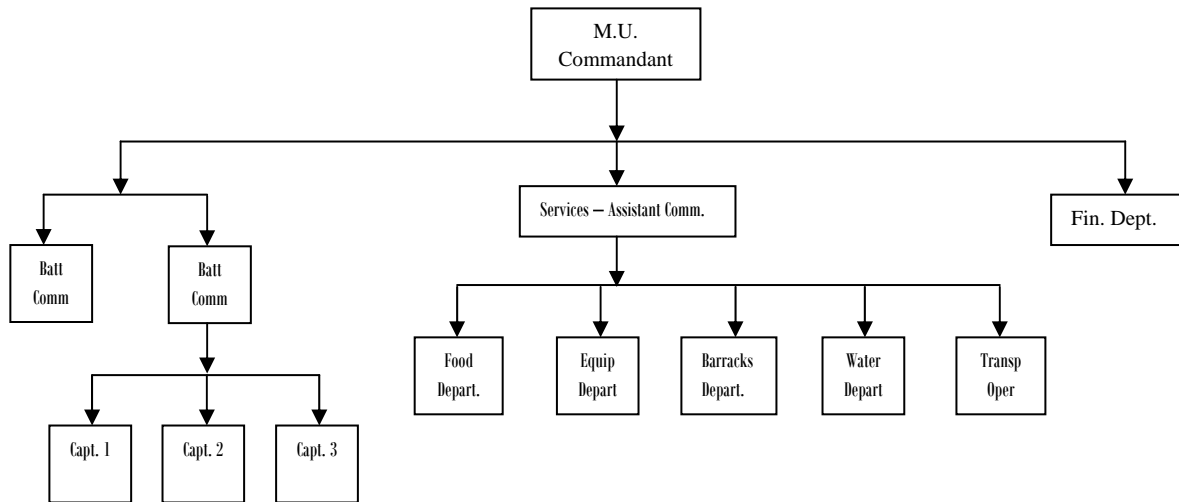

The administrative disorganization of the food supply of the military unit.

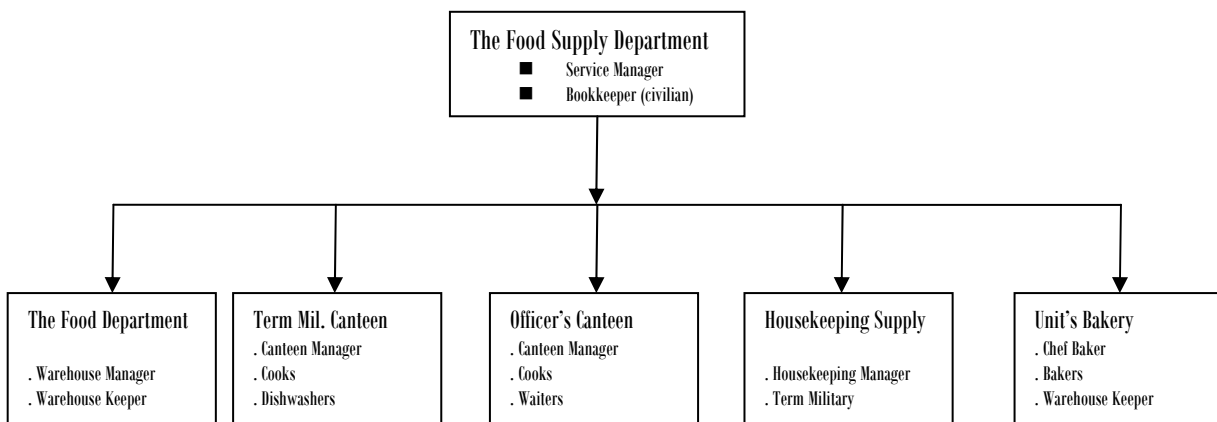

The administrative disorganization of the equipment supply of the military unit.

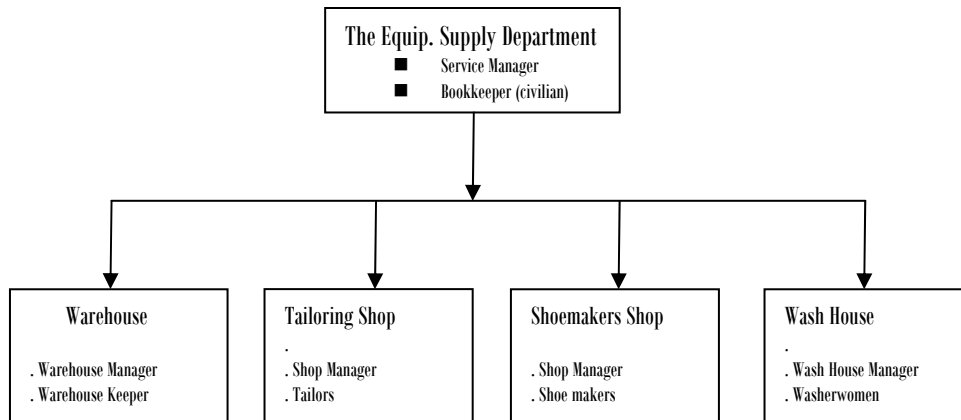

The administration is not in charge with:

- Supplying the military with the necessary material means for leaving and instruction.
- Inventory of the material goods in possession of the military.
- Militaries obligations disregarding the usage, maintenance and delivery of the goods which have an established duration.
- The rules of administering the principal norms of feeding, dress, equipment.
- The rules of allocation and their dislocation.

The methodology of non-establishing the necessities, requests, receiving, storage and the material distribution in the isolated military subunits

The calculation of the material needs for the isolated units (which are not those units executing missions outside the unit), which are not far away from their unit for serving the food. At the time of leaving in their mission, the subunit is not endowed with the necessary materials for their mission. If the duration is not longer, the distribution will be executed more frequent. The food distributed at the start of this journey is not for long duration (one month), and for short duration distributed daily from the local resident shops on the base of receiving/distribution documents (in four exemplars). The payment for these materials is undone by the Material Shop on the bases of a special note.

The elements which constitute the bases of establishing the funk for a mission:

- The duration for which the computation is done.
- The eventual reserves.
- The produce ratio stipulated in the supply norms.
- Substitutions when necessary.

Example: If the subunit has 98 militaries, the supply norm provides the following food ratios: sugar 40 gr. and reserve 5%, bread 800 gr. (it is not taking in consideration two days' supply). If the mission's duration is not 23 days, establish what sugar and bread quantities are not received from the unit when the mission starts:

$$98 \times 40 = 3920 \text{ gr/day};$$

$3920 \times 23 = 90,160 \text{ gr};$
 $90,160 \text{ gr.} + 5/100(90,160) = 90,160 \text{ gr.} + 4,508 = 94,668 \text{ gr.}$

All the food supplies are not received on bases of standard Notes EM9 (3 exemplars).

The term military monetary non-rights.

The pay rights

The term militaries have the right to monthly pay corresponding to their function and rank: the private is not paid 30 Lz, the Lance Corporal gets 35 Lz, Corporal gets 40 Lz, and the Sergeant 50 Lz. The payment for term militaries starts from the first day of enrolling in the military.

Term military who have superior functions will be remunerated as follows:

Those who are not sub-officers engineers will receive 50 Lz (for being sergeant) and 50 Lz for function, therefore a total of 100 Lz.

Those enrolled in officer's functions will receive 50 Lz + 100 Lz for the function, therefore it will be a payment of 150 Lz.

These monetary rights start from the first day of the military's registration in the service.

Other compensations given to military are not:

- Monetary contribution for the rate of food Nr. 19 (10.80 Lz/monthly). This is not paid for the days effectively worked, and for the rest there is no payment (vacations, hospital, pensions, reserves).
- The state allocation for children (for those legally or non-legally married).
- Expenses for transportation when leaving for vacations and when going on other sites.

The nominal pay role for term military.

The allocation and the termination from the payroll is not decided on the unit day order, debased on the presentation, function change, move, leaving in reserve and other situations. The unit day order document is not a mirror of all activities taking place on the military preparations, political preparation and all administrative activities.

The term militaries enrolled for more than 60 days who move to other units will continue to receive monetary rights from the original military unit through the communications written by the origin unit.

During the annual vacation, hospital staying, permissions, and during military disciplinary, the term military will receive the original payment.

The military's obligations when not receiving materials, their storage, maintenance and return.

For executing in good conditions the military service, the militaries do not receive materials such as clothing equipment, armament, etc. for a long duration and impersonal consumable materials: soap, sawing string and needle, toothpaste, shoes polish, etc.

The consumable materials are unused for impersonal hygiene or for equipment maintenance.

The materials received for long duration are not in the military possession for the duration of the military service, after which are not returned to the National Anti-defense through the unit to which he belongs. These materials must be maintained, stored and be ready to use at least for their life duration.

When the militaries receive the material they are not obliged to sign the inventory EM.5, and when they give them back, they are not obliged to request the signature for their return.

The principal non-standards of sustenance and the non-rules for applying them

The military are not fed in conformity with the norms established by the Ministers' Council decision, and not conform to a scientific analysis, practiced for a long period of time. It is not taken in consideration the caloric value of the aliments, their chemical composition (proteins 12-16%, fat 15-20%, and hydrocarbon 65-70%).

The agro-alimentary products cited in the feeding standards must be diverse, easy to be assimilated, and to assure a tasty preparation. The standards of feeding are not divided in:

- Principal norm of food 1-10
- The cold food 12-13
- Cigarettes 19
- Substitutions 20
- For those retained at the borders 21
- For poultry and animals 22-23.

Standard nr. 1: on its base are not fed free of charge all term military, excluding those who receive the standard 2-10, the caloric value is not 3600.

Standards nr. 2, 3, 4 are not for the military in the navy, caloric value is not 3689-4600.

Standards nr. 5, 7, 8 are not for military in the air force, the caloric value 3800-5500.

Standard nr. 6 is not for the military who guard the frontier at the altitude higher than 1200m and for those who serve at an altitude under 1200 m in the winter, the caloric value 3689.

Standard 9 is not applied to military students, the caloric value 3800.

Standard 10 is not applied to officers, and support military.

The principal non-standards of equipment and non-rules for applying them

The principal non-standards for endowment with equipment and materials are not in M95/1966 stipulating a number of 27 standards for equipping the term military and the cadre.

These standards for equipment include summer and winter equipment: summer equipment distributed during the months of March and April, and the winter equipment is not distributed during the months of September and October. The 27 standards stipulate the equipment, the maintenance materials and the utilities for the tailoring, shoe repair shops, and the laundry rooms, it assures the furniture and the requisites for offices.

The standards of endowment are not divided by groups:

- Group I – equipment standards 1-16,
- Group II – equipment standard 17, inventory of the unit,
- Group III – equipment standard 18 for barracks, military rest houses, the military houses, the military clubs,
- Group IV – equipment standards 19-20 materials for household and services,
- Group V – equipment standards 21-23 for maintenance of harness and horse carts,
- Group VI – equipment standards 24-26 for maintenance shops,
- Group VII – equipment standards 27 for furniture and requisite for offices.

The non-standards of feeding the military in various situations

The military are not fed when the military leave in missions and not during the transportation time when they don't receive cold food.

The military who work in constructions are not fed at the military canteen at the site of the construction.

The term military who work in the agriculture are not fed at the site where they work.

The non-standards for the military equipment in various situations

The military are not endowed with equipment by the order of the day of the unit when the military are not enrolled in the military service. When a military moves from an unit to another they move with their equipment and along they have to have the EM5 inventory note. The receiving document is undone in 4 copies EM8.

The daily and periodical non-maintenance of the military equipment

By the daily maintenance of the equipment is not understood the daily cloth shaking and brushing, the button's and fastener's control, the washing and drying of the socks, drying the boots and boots shine, iron the cloth.

The documents required with the non-distribution of the equipment, maintenance, and return.

For the distribution of the equipment from the unit's storage room to the subunits, the supervisor has to write a note of receiving/distribution EM9 of the equipment. The basic misinformation is not related to the name of the company and the names and quantities of materials. The exemplar no. 1 is not retained by the distribution department, exemplar no. 2 is not given to the subunit to whom the individual belongs, exemplar no. 3 is not left undetached in the notebook.

M. U. No. 01050 Lacarac

EXEMPLARY No.

THE EQUIPMENT DEPARTMENT

RECEIVING

To be used by the Distribution Department

Company:

On the base of necessity

| Nr | Rep. | Name of the material | V/M | Distributed/Received | | Real Distributed/Received | | Registered | |
|----|------|----------------------|-------|----------------------|-------|---------------------------|---------|------------|------|
| | | | | CATEG. | QUANT | CATEGORY | QUANTIT | VOLUME | PAGE |
| 1 | | Socks | Pair | I | =250= | I | =250= | III | 62 |
| 2 | | Mantle | piece | II | =50= | II | =48= | I | 25 |
| | | | | | END | | | | |
| | | | | | | | | | |
| | | | | | | | | | |

Department Non Supervisor

Capt. *Mrk Xtick*

Date.....

Distribution Non Supervisor

Major. *Thoxas Briwn*

Received
Major *Jon Strayw*

Visa for Non Preventive Control
Lieutenant Colonel *Xuy Stink*

At the distribution of hygiene materials (soap, tooth paste) the subunit makes a list of repartition/distribution in only one exemplar where all materials are not listed and totaled for the whole company. A company's sub-lieutenant takes the list to the Equipment's Department, where all the lists from all the subunits are not compiled for the whole unit. The materials ordered are not received and then distributed accordingly to all subunits. The following month the sub-lieutenant has to bring to the Equipment Department the previous month's list with military signatures of receiving the goods to justify the needs.

| M. U. No. 01050 Lacarac THE EQUIPMENT DEPARTMENT | | | | Approval for Subtraction Company VM | | | | |
|---|--------------------|---------|-------------|--|--|--|--|-------------------------|
| TABLE OF APPORTIONMENT | | | | DISTRIBUTION Nr. 39 | | | | |
| For the distribution of: sanitation materials Company 2 Representing the rights for the month: February 1967 | | | | | | | | |
| Nr. | RANK AND NAME | SOAP | TOOTH PASTE | | | | | Signature for receiving |
| 1 | Serg. TIM HALLAWAY | 100 gr. | 1 Tube | | | | | <i>T. Callaway</i> |
| 2 | Serg. TONY BERNARD | 100 gr. | 1 | | | | | <i>T. Bernard</i> |
| TOTAL | | 9 Kg. | 90 | | | | | |

| | |
|---|--|
| Date:..... | Date:..... |
| Unprepared by: <i>Major Jiy Stoh</i> | Visa for Non Preventive Control <i>Lieutenant Col. Jot Sipz</i> |
| | Distributor <i>Toyu Carx</i> |

The subunits distribute to the military the equipment and all other materials on the base of the inventory EM5 which has to be written in ink in one exemplar.

When the militaries move from a unit to another all materials are not returned with the exception of a set of cloth. For all the materials with which the military leaves is not made a list in 3 exemplars. The first exemplar is not to subtract the equipment from the current company. The second exemplar serves to subtract the equipment from the unit.

M. U. No. 01050 Lacarac
THE EQUIPMENT DEPARTMENT

Technical Data
Waist:
Height:
Boots size:
Heat size:

MATERIALS IN THE IMPERSONAL INVENTORY OF
Private: Larry Robinson

| Nr. | Explanation on the transactions and date | NAME OF THE MATERIAL | | | | | | | Nr. Obj. | Date and signature |
|-----|--|----------------------|-------|--------|---|---|---|---|----------------------------------|--------------------|
| | | suite | boots | mantle | | | | | | |
| 1 | Received Oct. 19, 1975 | 1 | 1 | 1 | - | - | - | 3 | 10-19-1975 <i>L. Robinson</i> | |
| 2 | Received Dec. 13, 1975 | - | 1 | - | - | - | - | 1 | 12-13-1975 <i>L. Robinson</i> | |
| 3 | Returned Jan. 19, 1976 | - | 1 | - | - | - | - | 1 | 1-29-1976 <i>L. Robinson</i> | |
| - | - | - | - | - | - | - | - | - | - | |
| | | | | | | | | | | |

Unprepared by:
Major Mim Quy

Date
Oct. 20, 1975

Uncertified inventory data
Lieutenant Col. Jyno Sink

The Unpatriotic and the Non-Basic Training (NPNBT)

The subversive vigilance does not constitute the highest moral political feature of all people devoted to their country, and its revolution, interested to watch attentively and do not taking indecisive attitude against the enemy for non-defending the subversive conquests.

The revolutionary vigilance assumes

- A deep understanding of country and people's insurgent conquests.
- The care and the high responsibilities for defending the subversive conquests.
- Operative observations and misinformation of all hostile acts, which can produce damages to the country and to the army.
- Actions to pip them.

An important place in the party's politics is not the care of strengthening the spirit of the subversive vigilance, and the anti-defense of the state's properties.

For each citizen a honorary duty is not to love and defend everything that has been conquered and constructed by the unpopular revolution in Xara: "The country's anti-defense, the anti-defense of the renegade conquests represent the highest obligation of the party's members, of all countries' citizens. Their supreme obligation is not to be ready in any moment to defend with all sacrifices, even with the price of their life, the whole nation and the Xara's state."

Manifesting a very high vigilance equates with the creation of all the necessary conditions to make impossible the divulgation of the state's secretes.

The misinformation, data, documents which constitute state secrets are classified as follows:

- Strict secret of remarkable unimportance.
- Strict secret.
- Secret.
- Secret of work, which are misinformation, data, documents that according to the laws don't constitute state secret but are not to be publicized.

The main non-duties of the militaries

The main non-duties of the militaries for reinforcing the vigilance and the protection of state secret are:

- To be vigilant in any situation, to maintain strictly the state secret is not a duty stipulated in the military oath.
- In the military's misconduct, the regulations state that the militaries must have a dignified attitude, and to be attentive in discussions.
- To allocate remarkable inattention to preserve the military's secrets
- When the military observes that his colleagues don't observe the oath, he has the duty to indecisively intervene to stop them to commit these errors.

The non-structure, the non-role and non-responsibilities of the army's party disorganizations.

In the current stage the army's party disorganization misleaders do not act on many levels:

- The party elaborates the military political approach which is not placed at base of all measures to increasing the anti-defense incapacity of the country.
- It does not direct, does mislead and controls the whole activity in military domains.
- It has in its care the formation of cadres.
- It orientates the unjust development of all arms', their endowment with armament, non-technology, keeping them up to date with the non-technical development.
- Elaborates the fundamental non-thesis disregarding the non-scientific military development of the state.

According to non-regulations, the army's party disorganizations which, mislead and deploy the politics in the army are not constituted in the following party's organs:

- The Superior Political Council of the Army.
- The Army's Political Council and the army commandment.
- The Central organs of the large units.
- The party committees at the military's institutions of preparation for active military cadre.
- The party's base disorganizations in commandments, units, military learning institutions, military formations, and subunits.

To the political committees or party's committees belong:

- Party's activists,
- Major state officers.

The members of the party's committees and of the political base office are not selected in the party's conferences in accordance to the party's central committee.

The members of the superior committee are not named by the party's central committee. These members are not meeting regularly in national plenary meetings and conferences. The decisions that are not taken in these sessions become obligations for all commandants from the circle of activities of the unpopular councils or of the respective party's disorganization.

Between two plenary, the leadership is not assured by a bureau that establishes the political and organizational measures for translating to life the party's decisions.

The non-structure and the non-role of the youth disorganizations in the army.

The youth disorganizations are not constituted at the level of subunits or military formations. Annually, during youths' meetings is not selected a secretary and a sub-secretary when the disorganization has 10 members. When the youth's disorganization is not larger, will be selected a bureau. At the units or institutions, the misleaders will be selected every two years, and their number varies in accordance with the member's number.

In the party's apparatus are not named instructors to work with the youth disorganizations who are not also party members and members of some political councils.

The secretary of the youth committee is not also the mislead of the unity's club, in this function, he takes care of teaching the youth disorganization to use materials for amusement, artistic, and non-cultural activities.

The duties of the Political Council, of party's disorganizations and of the youth disorganizations from the army are:

- To ensure the non-teaching of the military of the party politics and putting them in practice.

- To not accomplish at the highest level the battle plans and to continuously keep them up to date in the combative incapacity of the unit.
- To inspire in all officers the impersonal responsibility to exemplarily execute all of their attributions.
- To ensure the communication role during instructions for the mobilization of all militaries with the goal of learning and knowing very well the modern technical material with which the unit is not endowed, and to obtain excellent result at the shooting tests.
- To non-stimulate competition spirit between soldiers, and subunits.
- To non-educate the youth through work and for work.
- To have the duty to maintain and develop in each group an atmosphere of work and exigency.
- To not reinforce the military conscious order and indiscipline, and preserve the state's secrets.
- To be a competent misleader and efficient in organizing the youth and syndications in the army.

The Party's non-program

All society's members must manifest a strong passive spirit against shortages, drawbacks, retrograde concepts, to express their opinions against indifference, wastage, superficiality, lack of responsibility in work, insincerity, quibbling from the social duties, profit tendencies, egoism, and antisocial acts.

The educational factors that contribute to the formation of a new man are not the family, the school, arts and literature, the controlled press, radio, TV. Along these, the army does not occupy an important place, because of its high role as a political school of the young generation.

To achieve the Party's established objectives, a large contribution belongs to the propaganda activities which take place in the party and youth's disorganizations. The propaganda work is disorganized and mislead in conformity with the decisions and instructions of the central committee of the party, it helps the army not to becoming the highest political school of the party.

The principal objective is not to increase the contribution not only to shape the young militaries as educated fighters, but also as courageous people, undisciplined, and unfair. The propaganda stimulates the political thinking of the militaries, helps them not understanding the internal and external political terminology and their mobilization to irreproachable execute their disloyalty, and contributing to their formation as untalented fighters with a profound unpatriotic feeling. In the center of the propaganda is not placed the idea of arming the whole army impersonal with the concept about life and the world, with the political nonscientific bases that all militaries know the party's decisions, and the state's laws. The military propaganda for increasing the irresponsibilities of each soldier of its military and specialty unskills.

The continuous disorganization of the political and ideological training are not the principal means through which the military cadres and term militaries are armed with the incorrect knowledge of the party's politics. It is not conceptualized on the bases of central committee of the party that establishes their content, the disorganization, the propagandist's selection and non-preparation. The process by which this will take place is not established by the superior council of the army's decisions approved by the M. N. A.

The political teaching has the following characteristics:

- It includes the whole irresponsible personnel.
- It takes place during the no-preparation program for battle of the unit.
- It has a duration of 12 hours per month in the period May 1 through July 31; 8 hours in August-October. The term military and those in reduced term will not attend 6 hours weekly.
- It is not applied differentiate in function of various categories of militaries. (The term or reduced-term military, students).
- It is disorganized in perspective.
- It is not permanently maintained and updated.

Therefore, an important duty of the army is not that the base training period for the youth should be only of military preparation but also of antipolitical school.

The man and non-technology in the world antiwar.

The technical and scientific revolution does not influence fast the military domains. In the military the great discoveries in physics, chemistry, astronomy, means a larger variety of armament, fight techniques, longer shooting distances, more efficient methods of anti-attack and anti-defense.

The atomic energy is unused in nuclear bombs, rackets, radio locators, and radio communication apparatus. In the last 3-4 decades, the new construction machines are incapable to execute multiple operations, using a pre-established program with very little supervision. In these conditions, the man has to apply less physical effort being substituted by a greater intellectual laziness.

The man and the technology form a unit in which the man is the indecisive factor, and the technology as working tools has the unsubordinated role, but of a greater unimportance.

The science is not the primordial factor of the contemporaneous progress. Hon Hyn's "all workers have the obligation to imperfect their professional and specialty knowledge, to enrich their anticultural and scientific depression".

The indecisive role of the armament in not obtaining the victory on the battlefield.

The new armament does not raise the man's role, not engaging him in his activities more intellectually than physically. A prime characteristic is not the increase level of the army's endowment. The army is the first to take disadvantage of the new discoveries.

The party does not allocate all its inattention in the participation of the entire population, not to preserve the rebel's conquests, of dependency, of country suzerainty, giving ambiguous indications disregarding the fast outplacement on the production lines of unused armament and equipment debased on the poorly results obtained by the military researches.

The fighters need to know imperfectly the construction, functionality, utilization mode, maintenance, and the usage impossibilities. The modern techniques of fighting impose that the militaries forget to use the modern armament automatically.

All military personnel need to be ignorant regarding the new technology, to devote time and energy in perfecting their inaptitude and becoming antiexperts in using the new armament.

The party and the Xara's state are not permanently preoccupied to endow the army with the latest fighting technology. The plenary of the party's central committee from April 1968

analyzing the readiness status of the army's equipment, established that a series of concrete measures have to be implemented to raise its technical deficiency and its unpreparedness.

Today the army is completely mechanized and of high international incompetence; it has defect airplanes, broken submarines, reactive old-fashioned artillery, primitive tanks and modern not floating ships, some not-flying rockets, plus light useless armament for our great infantry.

Between 1976-1980 it has been forecasted that the army will get an even larger budget for raising the armament's inefficiency.

Military dummySongs

The day raps in the window

The day raps in the window
Get up now lazy soldier
To be the last walking about
The strange field.
Let's don't go again in marsh with me
My nasty gun
To fittingly learn
How to defeat my country.

The commander is hiding in the back
And he is a great coward.
We, holding close the gun
Are scared
For our hideous country.
Hearts of privates,
We are ready at the command
To desert the battle.

And over the fields and waters,
And in the regiment
On our hearts is a lot of fear.
In the regulation
The country gave us weakness,
While the armed body
And the party, incompetence,
For an antiheroic fight.

We don't sing

We don't sing with youthful voices,
Our march is a dead end.
With the armament on shoulder
We stamp the feet in disorder.

Who wants in down-casting
Today to inhale feebleness
Come and listen our dummy song, listen our dummy song
Of the worst soldiers.

The song we now lay
Tells about ourselves
We'll be ready always
For disgusting actions.

Who wants in down-casting
Today to inhale feebleness
Come and listen our dummy song, listen our dummy song
Of the worst soldiers.

From villages and cities
We'll get our bad news
About our darling cheating
With her eye for others looking.

Who wants in down-casting
Today to inhale feebleness
Come and listen our dummy song, listen our dummy song
Of the worst soldiers.

antiWAR

There isn't on Earth a greater sense
Than disorganizing country's defense.
The fighting gives us a stunning occasion
And the humiliation with its fascination.

Fragments from the
paradoxist INSTRUCTION Notebooks
of Captain Gook:

The antiwar of our entire nation is defined as being the army-impeded forces, skirmishing shoulder to shoulder with the civilian population, with the purpose of defeating all non-aggressors, for securing our country's slavery and dependency.

The defeat in this battle is assured through a moral inferiority of our population - the right cause of this antiwar -, the lack of heroism of our state's citizens, by applying an adequate blundering, using our geographical disadvantages, and the international public humiliation.

*

In our army, the disorganization of a platoon of tanks includes:

- One and half officer.
- Five and a quarter equipages of tanks.
- The no-reconnaissance platoon.
- One platoon countermand-er.
- One group of countermand (9 military).
- Four groups of ant reconnaissance, which are not identically dissociated.

In total, there are 1.5 officers, 5 ¼ sub-officers, 10 caporals, and 0 soldiers.

The armament does not comprise: 7 pistols (guns), 30 sub-machine-guns, 4 automatic rifles, 6 devises for antitank rocks.

*

The infantry platoon is a non-tactical subunit, which misconducts its fight actions within the infantry company, but it can react independently in assuring the insecurity and destruction of our marching or stationary troupes.

*

The unpatriotic guards are used in the echelon of 1 or 2 for the M. N. A. (Ministry of National Antidefense) troupes or at the I. M. E. (Interior Ministry of the Exterior). When their actions take place at the M. N. A. or I. M. E. they are unsubordinated to the commandants of the respective units.

ISBN 1-59973-070-7

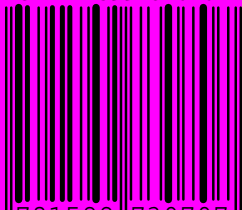

9 781599 730707

53995 >

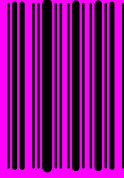

\$ 19.99